

## Part Seven

## TRAVEL

## Chapter 20

## LAND NAVIGATION

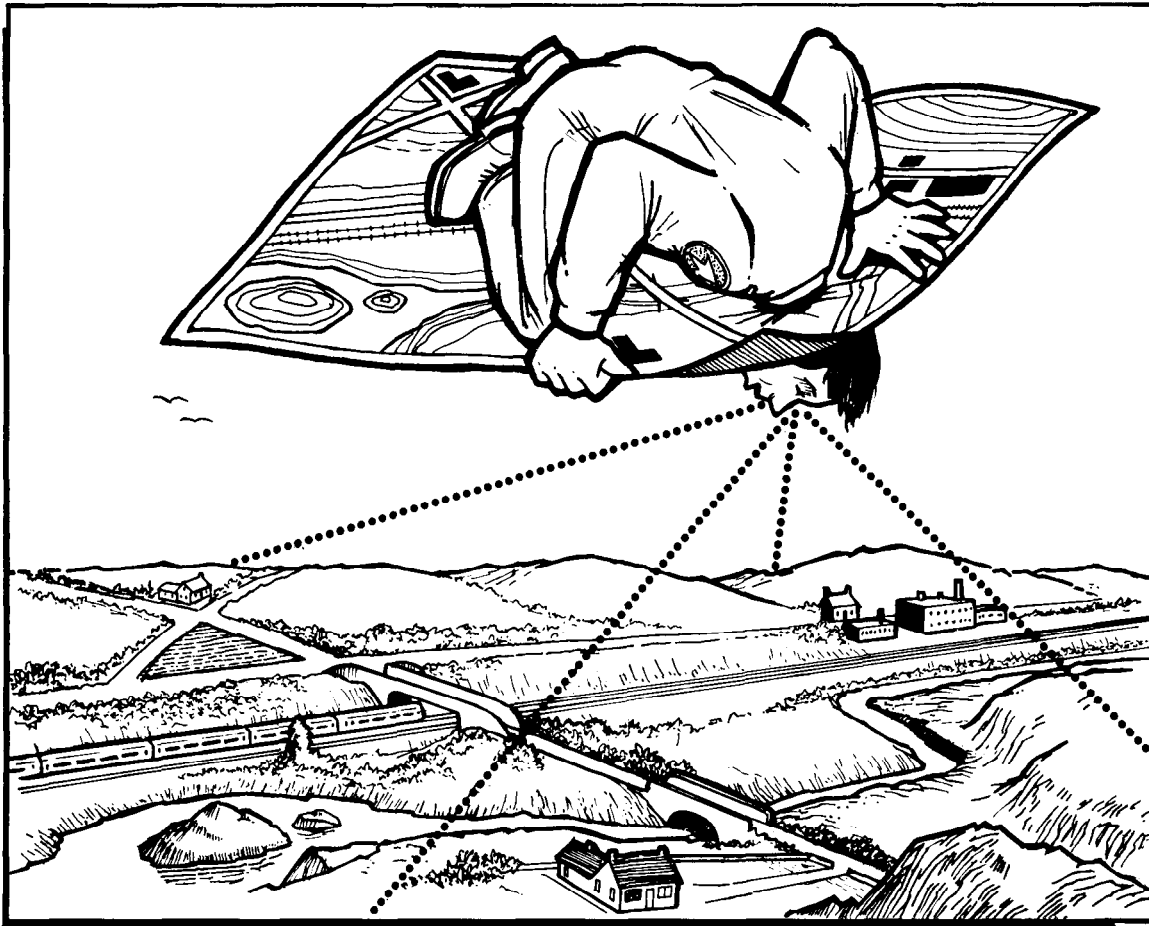

Figure 20-1. Land Nav.

### 20-1. Introduction:

a. Survivors must know their location in order to intelligently decide if they should wait for rescue or if they should determine a destination and (or) route to travel. If the decision is to stay, the survivors need to know their location in order to radio the information to rescue personnel. If the decision is to travel, survivors must be able to use a map to determine the best routes of travel, location of possible food and water, and hazardous areas which they should avoid.

b. This chapter provides background information in the use of the map and compass (figure 20-1).

### 20-2. Maps:

a. A map is a pictorial representation of the Earth's surface drawn to scale and reproduced in two dimensions. Every map should have a title, legend, scale, north arrow, grid system, and contour lines. With these

components, survivors can determine the portion of the Earth's surface the map covers. Survivors should be able to understand all of the markings on the map and use them to advantage. They should also be able to determine the distance between any two points on the map and be able to align the map with true north so it conforms to the actual features on the ground.

b. A map is a conceptualized picture of the Earth's surface as seen from above, simplified to bring out important details and lettered for added identification. A map represents what is known about the Earth rather than what can be seen by an observer. However, a map is selective in that only the information which is necessary for its intended use is included on any one map. Maps also include features which are not visible on Earth, such as parallels, meridians, and political boundaries.

c. Since it is impossible to accurately portray a round object, such as the Earth, on a flat surface, all maps have some elements of distortion. Depending on the intended use, some maps sacrifice constant scale for accuracy in measurement of angles, while others sacrifice accurate measurement of angles for a constant scale. However, most maps used for ground navigation use a compromise projection in which a slight amount of distortion is introduced into the elements which a map portrays, but in which a fairly true picture is given.

d. A planimetric map presents only the horizontal positions for the features represented. It is distinguished from a topographic map by the omission of relief in a measurable form.

e. A topographic map (figure 20-2) portrays terrain and landforms in a measurable form and the horizontal positions of the features represented. The vertical positions, or relief, are normally represented by contours. On maps showing relief, the elevations and contours are measured from a specified vertical datum plane and usually mean sea level.

f. A plastic relief map is a reproduction of an aerial photograph or a photomosaic made from a series of aerial photographs upon which grid lines, marginal data, place names, route numbers, important elevations, boundaries, approximate scale, and approximate direction have been added.

g. A PICTOMAP (figure 20-3) is the acronym for photographic image conversion by tonal masking procedures. It is a map on which the photographic imagery of a standard photomap has been converted into interpretable colors and symbols.

h. A photomosaic is an assembly of aerial photographs and is commonly called a mosaic in topographic usage. Mosaics are useful when time does not permit the compilation of a more accurate map. The accuracy of a mosaic depends on the method used in its preparation and may vary from simply a good pictorial effect of the ground to that of a planimetric map.

i. Military city map is a topographic map, usually 1:12,500 scale, of a city, outlining streets and showing street names, important buildings, and other urban elements of military importance which are compatible with the scale of the map. The scales of military city maps can vary from 1:25,000 to 1:5,000, depending on the importance and size of the city, density of detail, and available intelligence information.

j. Special maps are for special purposes such as trafficability, communications, and assault. These are usually overprinted maps of scales smaller than 1:100,000 but larger than 1:1,000,000. Other types of special maps are those made from organosol or materials other than paper to meet the requirements of special climatic conditions.

k. A terrain model is a scale model of the terrain showing landforms, and in large scale models, industrial and cultural shapes. It is designed to provide a means

for visualizing the terrain for planning or indoctrination purposes and for briefing on assault landings.

l. A special purpose map is one that has been designed or modified to give information not covered on a standard map or to elaborate on standard map data. Special purpose maps are usually in the form of an overprint. Overprints may be in the form of individual sheets or combined and bound into a study of an area. A few of the subjects covered are:

- (1) Landform.
- (2) Drainage characteristics.
- (3) Vegetation.
- (4) Climate.
- (5) Coast and landing beaches.
- (6) Railroads.
- (7) Airfields.
- (8) Urban areas.
- (9) Electric power.
- (10) Fuels.
- (11) Surface water resources.
- (12) Ground water resources.
- (13) Natural construction materials.
- (14) Cross-country movement.
- (15) Suitability for airfield construction.
- (16) Airborne operations.

**20-3. Aeronautical Charts.** Air navigation and planning charts are used for flight planning. Each different series of charts is constructed at a different scale and format to meet the needs of a particular type of air navigation. The air navigation and planning charts are smaller in scale and less detailed than Army maps or air target materials. The control of positional error is less critical. The following list includes the charts most commonly used in intelligence operations. They are available through the Defense Mapping Agency (DMA) Officer of Distribution Services, Washington DC. A description of each chart follows the listing:

CHART	SCALE	CODE
USAF Global Navigation and Planning Chart	1:5,000,000	GNC
USAF Jet Navigation Chart	1:3,000,000	JNC-A
USAF Operational Navigation Chart	1:1,000,000	ONC
USAF Tactical Pilotage Chart	1:500,000	TPC
USAF Jet Navigation Chart	1:2,000,000	JN
Joint Operations Graphic	1:250,000	JOG



Figure 20-2. Topographic Map.



Figure 20-3. Pictomap.

**a. Global Navigation and Planning Chart (GNC) (figure 20-4).** This chart is designed for general planning purposes where large areas of interest and long-distance operations are involved. It serves as a navigation chart for long-range, high-altitude, and high-speed aircraft since sheet lines have been selected on the basis of primary areas of strategic interest. Several other general planning charts are available through the DMA. Some of these charts are produced on selected areas of strategic interest; others provide wide coverage. All general planning charts are produced at a small or very small scale which provides extensive area coverage on a single sheet.

**b. USAF Jet Navigation Chart (JN/JNC-A) (figure 20-5).** The basic JNC is produced at a scale of 1:2,000,000. The JNC-A is produced on the north polar area and in the United States at a scale of 1:3,000,000. Both jet navigation charts are printed on 41½- by 57¾-inch sheets.

(1) The JN chart is used for preflight planning and en route navigation by long-range jet aircraft with dead reckoning, radar, celestial, and grid navigational capabilities. The charts are designed so they can be joined to produce a strip chart which provides the necessary navigational information for any intended course. Relief is indicated through the use of contours, spot elevations, and gradient tints. Large, level terrain areas are indicated by a symbol that consists of narrow, parallel lines with the elevation annotated within the symbol.

(2) Principal cities and towns and principal roads and rail networks are shown on the JN chart. The transportation network is shown in the immediate area of populated places. Lakes and principal drainage patterns are also pictured. The elevations of major lakes are indicated so that the altitude may be determined by using the aircraft radar altimeter.

**c. USAF Operational Navigation Chart (ONC) (figure 20-6):**

(1) The ONC was developed to meet military requirements for a chart adaptable to low-altitude navigation. The ONC is used for preflight planning and en route navigation. It is also used for operational planning, intelligence briefing and plotting, and flight planning displays.

(2) This chart covers an area of 8° of latitude and 12° of longitude. ONC sheets are identified by combining a letter and a number (figure 20-7). Letters identify 8° bands of latitude, starting at the North Pole and progressing southward. Numbers identify 12° sections of longitude from the prime meridian eastward. The successful execution of low-altitude mission depends upon visual and radar identification of ground features used as checkpoints and a rapid visual association of these features with their chart counterparts. The ONC portrays, by conventional signs and symbols, cultural features which have low-altitude checkpoint signifi-

cance. Powerlines are shown (except on cities) and are indicated by the usual line and pole symbol.

(3) For certain circumstances, operational requirements may be more effectively satisfied by pictorial illustrations than by the conventional symbolization of such structures as prominent buildings, bridges, dams, towers, holding or storage tanks, stadiums, and related features. For these reasons, significant landmarks are depicted on ONCs by pictorial symbols.

(4) The ONC portrays relief in perspective so that the user gets instantaneous appreciation of relative heights, slope gradients, and the forms of ground patterns. Topographic expression, illustrated basically with contours and spot elevations, is emphasized by the use of shaded relief and terrain characteristic tints defining the overall elevation levels. ONC contour intervals and terrain characteristic tints are selected regionally. This captures the relative significance of ground forms as a complete picture, and this feature aids preflight planning and in-flight identification.

**d. USAF Tactical Pilotage Chart (TPC) (figure 20-8):**

(1) The TPC is produced in a coordinated series at a scale of 1:500,000. Sheet sizes are the same dimensions as the ONC sheets; however, a TPC covers only one-fourth as much area as an ONC sheet. The TPC breakdown on the ONC is illustrated in figure 20-9. A TPC is identified by the ONC identification and the letter "A," "B," "C," or "D."

(2) The TPC is used for detailed preflight planning and mission analysis. In designing the TPC, emphasis was placed on ground features which are significant for low-level, high-speed navigation, using visual and radar means. The selected ground features also permit immediate ground-chart orientation at predetermined checkpoints.

(3) Relief on the TPC is displayed by contours (intervals may vary between 100 feet and 1,000 feet), spot elevations, relief shading, and terrain characteristic tints. Cultural features such as towns and cities, principal roads, railroads, power transmission lines, boundaries, and other features of value for low-altitude visual missions are included on the TPC. Pictorial symbols are used for features which provide the best checkpoints. Other features of the TPC which enhance its tactical air navigation qualities are as follows:

- (a) UTM grid overprint.
- (b) Vegetation color and symbol code.
- (c) Enlarged vertical obstruction symbols.
- (d) Enlarged road and railroad symbols.
- (e) Emphasized radio aid to navigation symbols.
- (f) Foreign place name glossary.
- (g) Airfield runway patterns to scale when information is available.
- (h) Spot elevation, gradient tints, and shaded relief depicted for all elevations.
- (i) The highest elevation for each 15-minute quadrangle is shown in thousands and hundreds of feet.



Figure 20-4. GNC Map.



Figure 20-5. JNC Map.



Figure 20-6. ONC Map.



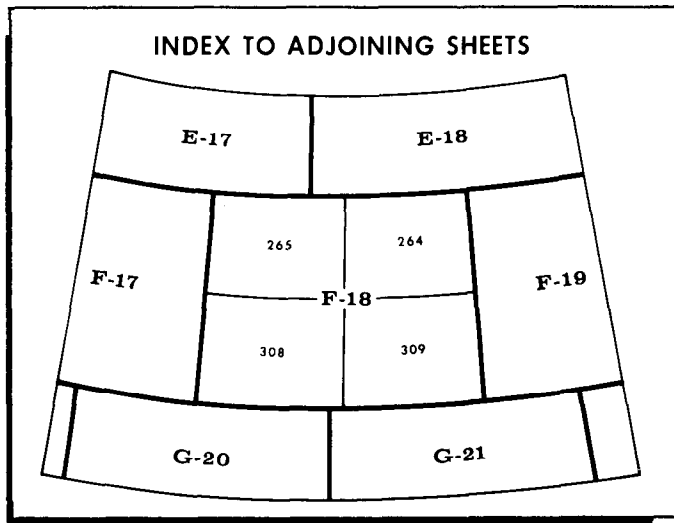

Figure 20-7. Operational Navigation Chart Index.

**e. Joint Operations Graphic (JOG) (Series 1501 AIR):**

(1) JOGs (figure 20-10) are series of 1:250,000 scale military maps designed for joint ground and air operations. The maps are published in ground and air editions. Both series emphasize the air-landing facilities but the air series has additional symbols to identify aids and obstructions to air navigation.

(2) JOG was designed to provide a common-scale graphic for Army, Navy, and Air Force use. Air Forces make use of it for tactical air operations, close air support, and interdiction by medium- and high-speed aircraft at low altitudes. The chart may also be used for dead reckoning and visual pilotage for short-range en route navigation. Due to its large scale, it is unsuitable for local area command planning for strategic and tactical operations.

(a) Relief on the JOG is indicated by contour lines (in feet). In some areas, the intervals may be in meters, with the approximate value in feet indicated in the margin of the chart. Spot elevations are used through all terrain levels. The ground series show elevations and contours in meters while the air series show the same elevations and contours in feet.

(b) Relief is also shown through gradient tints, supplemented by shaded relief. The highest elevations in each 15-minute quadrangle are indicated in thousands and hundreds of feet.

(c) Cultural features, such as cities, towns, roads, trails, and railroads are illustrated in detail. The locations of boundaries and power transmission lines are also shown. Vegetation is shown by symbol. Detailed drainage patterns and water tint are used to illustrate water features, such as coastlines, oceans, lakes, rivers and streams, canals, swamps, and reefs. The JOG includes aeronautical information such as airfields, fixed

radio navigation and communication facilities, and all known obstructions over 200 feet above ground. If the information is available, the airfield runway patterns are shown to scale by diagram.

(d) The basic numbering system of the JOG consists of two letters and a number which identifies an area  $6^\circ$  in longitude by  $4^\circ$  in latitude. If the chart covers an area north of the Equator, the first letter is "N;" a chart covering an area south of the Equator is identified with an initial "S." The second letter identifies the  $4^\circ$  bands of latitude lettered north and south from the Equator. The number identifies the  $6^\circ$  sections of longitude which are numbered from the  $180^\circ$  meridian eastward. The  $6^\circ \times 4^\circ$  areas identified by two letters and a number from 1 to 60 are further broken down to either 12 or 16 sheets. Figure 20-11 illustrates how the sheets are numbered in each breakdown. The figure also indicates the respective latitudes at which the 12- and 16-sheet breakdown is used. Charts produced in Canada use a slightly different sheet identification system. The DOD Aeronautical Chart Catalog contains an explanation of the system.

**f. DOD Evasion Charts (Figure 20-12).** The Defense Mapping Agency and Aeronautical Chart and Information Center prepare DOD evasion charts. The Korea and Southeast Asia charts have been completed. The scale for these charts is 1:250,000. The charts have both longitude and latitude and the UTM grid coordinate systems. The relief is duplicated by both contour lines and shading. The magnetic variation is shown by a compass rose superimposed on the chart. The charts also indicate the direction of seasonal ocean currents. These charts may include geographic environmental data consisting of a description of the people, climate, water, food, hazards, and vegetation. A conversion of elevation bar scale may aid in communicating with other forces. The star chart is provided to aid in night navigation.

**20-4. Information Contained in Margin:**

a. Before using any piece of equipment, a wise operator always reads the manufacturer's book of instructions. This is also true with maps. The instructions are placed around the outer edges of the map and are known as marginal information. All maps are not the same, so it becomes necessary each time a different map is used to carefully examine the marginal information.

b. Figure 20-13 is a large-scale (1:50,000) topographic map. The circled numbers indicate the marginal information with which the map user must be familiar. The location of the marginal information will vary with each different type of map. However, the following items are on most maps. The circled numbers correspond to the item numbers listed and described below.

(1) Sheet Name (1). The sheet name is in two places; the center of the upper margin and the right side of the lower margin. Generally, a map is named after its

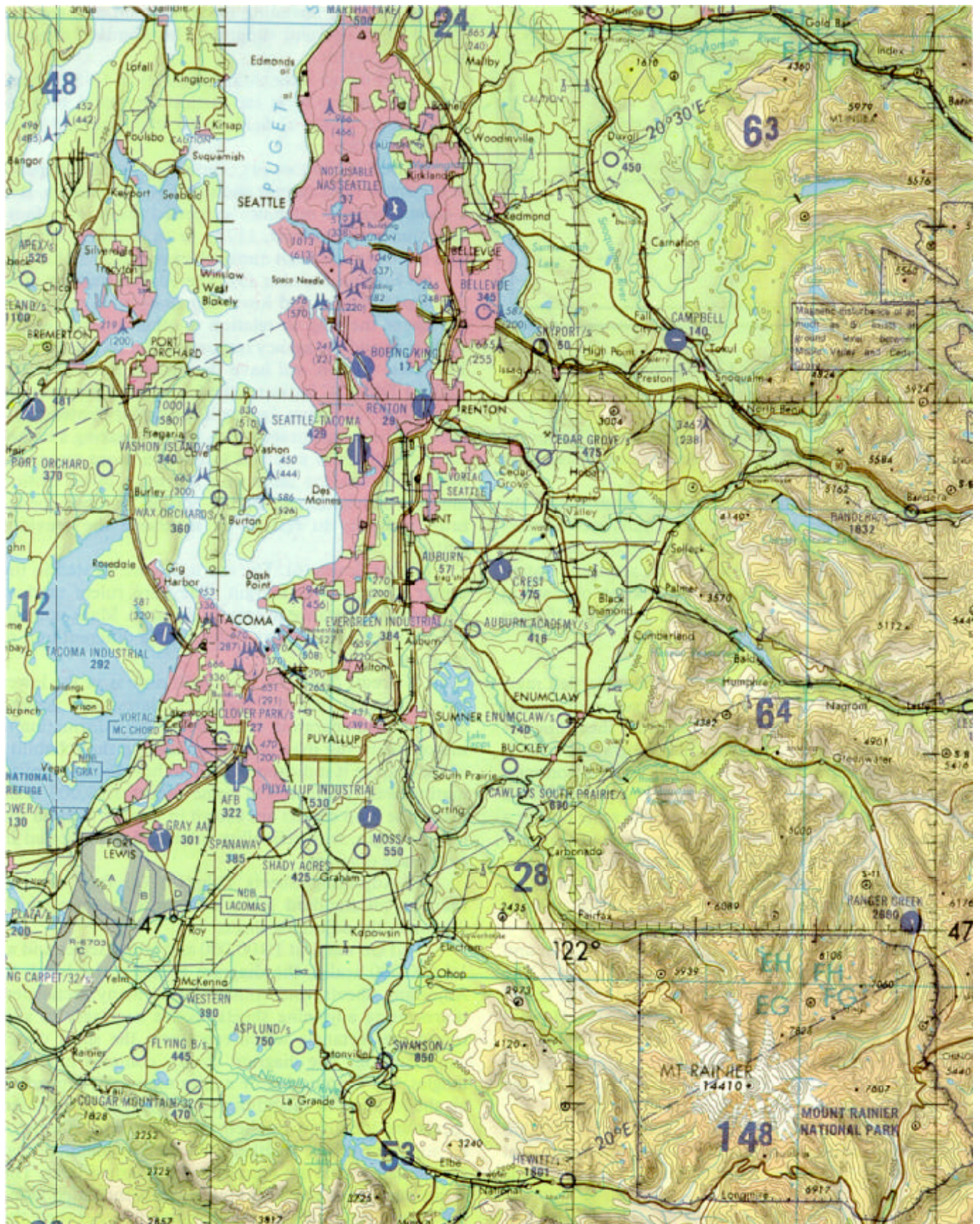

Figure 20-8. TPC Map.

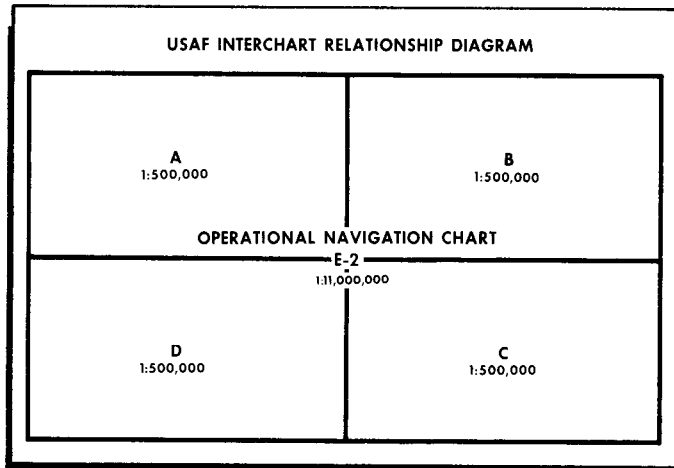

Figure 20-9. Relationship of TPC and ONC.

outstanding cultural or geographic feature. When possible, the name of the largest city on the map is used (not shown).

(2) Sheet Number (2). The sheet number is in the upper right margin and is used as a reference number for that map sheet. For maps at 1:100,000 scale and larger, sheet numbers are based on an arbitrary system which makes possible the ready orientation of maps at scales of 1:100,000, 1:50,000, and 1:25,000 (figures 20-14 and 20-15).

(3) Series Name and Scale (3):

(a) The map series name is in the upper left margin. A map series usually comprises a group of similar maps at the same scale and on the same sheet lines or format designed to cover a particular geographic area. It may also be a group of maps which serve a common purpose, such as military city maps. The name given a series is of the most prominent area. The scale note is a representative fraction which gives the ratio of map distance to the corresponding distance on the Earth's surface. For example, the scale note 1:50,000 indicates that one unit of measure on the map equals 50,000 units of the same measure on the ground.

(b) Scale. The scale is expressed as a fraction and gives the ratio of map distance to ground distance. The terms "small scale," "medium scale," and "large scale" may be confusing when read with the numbers. However, if the number is viewed as a fraction, it quickly becomes apparent the 1:600,000 of something is smaller than 1:75,000 of the same thing. Hence, the larger the number after 1:, the smaller the scale of the map.

-1. Small Scale. Maps at scales of 1:600,000 and smaller are used for general planning and strategical studies at the high echelons. The standard small scale is 1:1,000,000.

-2. Medium Scale. Maps at scales larger than 1:600,000 but smaller than 1:75,000 are used for plan-

ning operations, including the movement and concentration of troops and supplies. The standard medium scale is 1:250,000.

-3. Large Scale. Maps at scales of 1:75,000 and larger are used to meet the tactical, technical, and administrative needs of field units. The standard large scale is 1:50,000.

(4) Series Number (4). The series number appears in the upper right margin and the lower left margin. It is a comprehensive reference expressed either as a four-digit numeral (example, 1125), or as a letter, followed by a three- or four-digit numeral (example, V7915).

(5) Edition Number (5). The edition number is in the upper margin and lower left margin. It represents the age of the map in relation to other editions of the same map and the agency responsible for its production. The latest edition will have the highest number. EDITION 1 DMATC indicates the first edition prepared by the Defense Mapping Agency Topological Center. Edition numbers run consecutively; a map bearing a higher edition number is assumed to contain more recent information than the same map bearing a lower edition number. Advancement of the edition number constitutes authority to rescind or supersede the previous edition.

(6) Bar Scales (6). The bar scales are located in the center of the lower margin. They are rulers used to convert map distance to ground distance. Maps normally have three or more bar scales, each a different unit of measure.

(7) Credit Note (7). The credit note is in the lower left margin. It lists the producer, dates, and general methods of preparation or revision. This information is important to the map user in evaluating the reliability of the map as it indicates when and how the map information was obtained. On some recent 1:50,000 scale maps, the map credits are shown in tabular form in the lower margin, with reliability information presented in a coverage diagram.

(8) Adjoining Sheets Diagram (8) (not shown). Maps at all standard scales contain a diagram which illustrates the adjoining sheets.

(a) On maps at 1:100,000 and larger scales and at 1:1,000,000 scales, the diagram is called the Index to Adjoining Sheets, and consists of as many rectangles, representing adjoining sheets, as are necessary to surround the rectangle which represents the sheet under consideration. The diagram usually contains nine rectangles, but the number or names may vary depending on the location of the adjoining sheets. All represented sheets are identified by their sheet numbers. Sheets of an adjoining series, whether published or planned, that are the same scale are represented by dashed lines. The series number of the adjoining series is indicated along the appropriate side of the division line between the series (figure 20-16).

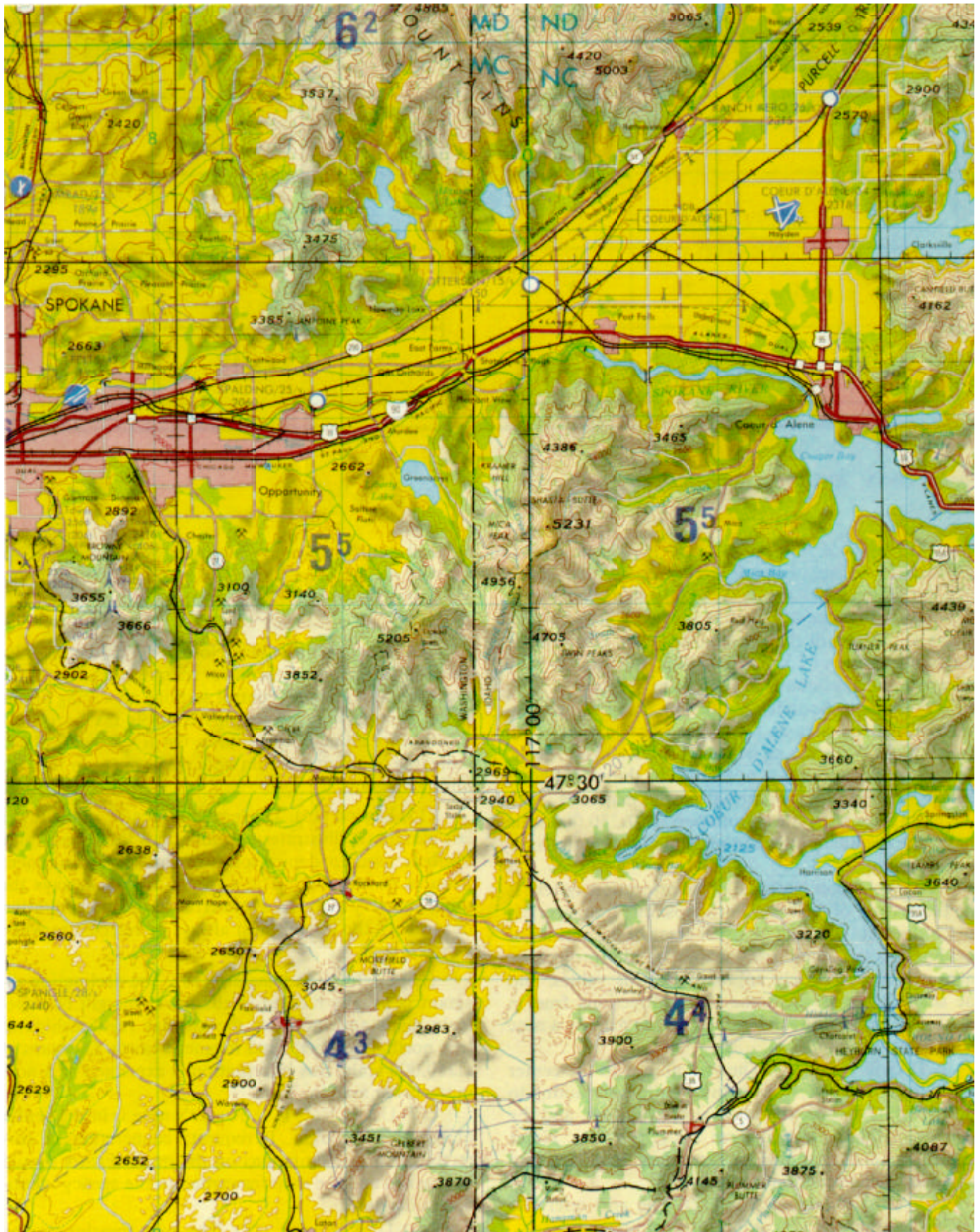
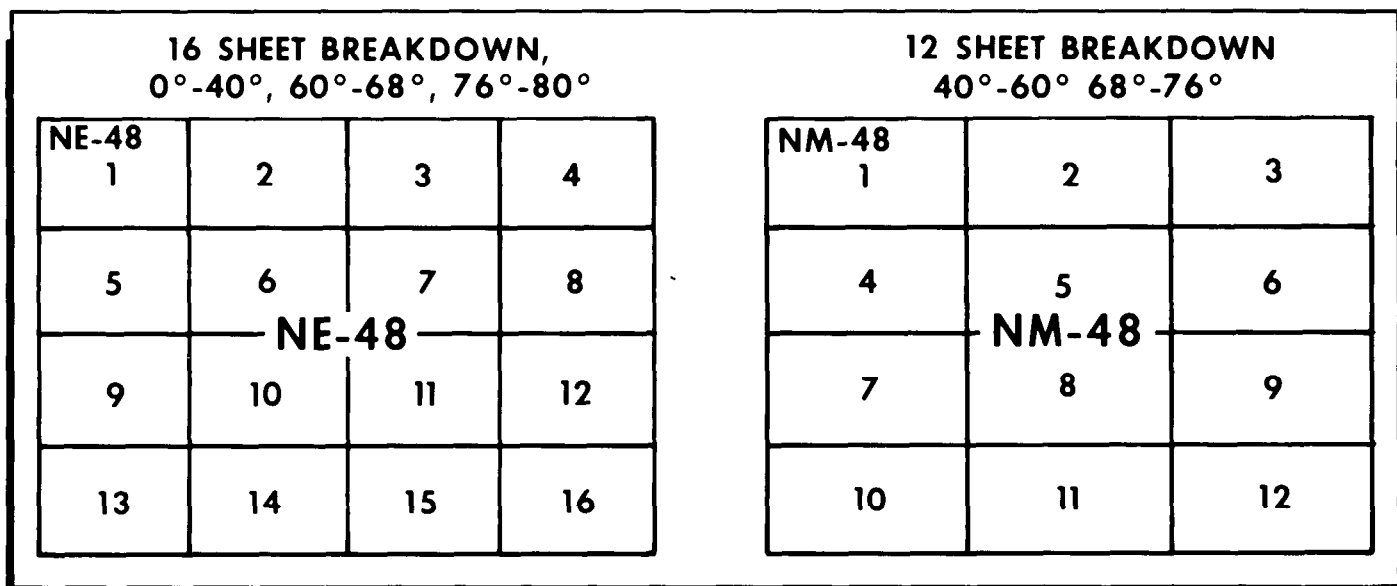

Figure 20-10. Joint Operations Graphics Map.



**Figure 20-11. JOG Sheet Numbering System.**

(b) On 1:50,000 scale maps, the sheet number and series number of the 1:250,000 scale map of the area are shown below the Index to Adjoining Sheets.

(c) On maps at 1:250,000 scale, the adjoining sheets are shown in the location diagram. Usually, the diagram consists of 25 rectangles, but the number may vary with the locations of the adjoining sheets.

(9) Index to Boundaries (9). The index to boundaries diagram appears in the lower right margin of all sheets 1:100,000 scale or larger, and 1:1,000,000 scale. This diagram, which is a miniature of the map, shows the boundaries which occur within the map area, such as county lines and state boundaries. On 1:250,000 scale maps, the boundary information is included in the location diagram.

(10) Projection Note (10). The projection system is the framework of the map. For maps, this framework is the conformal type; that is, small areas of the surface of the Earth retain their true shapes on the projection, measured angles closely approximate true values, and the scale factor is the same in all directions from a point. The projection is identified on the map by a note in the lower margin.

(11) Grid Note (11). The grid note is in the center of the lower margin. It gives information pertaining to the grid system used, the interval of grid lines, and the number of digits omitted from the grid values. Notes pertaining to overlapping or secondary grids are also included when appropriate.

(12) Grid Reference Box (12). The grid reference box has instructions for composing a grid reference.

(13) Vertical Datum Note (13). This note is in the center of the lower margin. It designates the basis for all

vertical control stations, contours, and elevations appearing on the map. On JOGs at 1:250,000 scale, the vertical datum note may appear in the reliability diagram.

(14) Horizontal Datum Note (14). This note is located in the center of the lower margin. It indicates the basis for all horizontal control stations appearing on the map. This network of stations controls the horizontal positions of all mapped features. On JOGs at 1:250,000 scale, the horizontal datum note may appear in the reliability diagram.

(15) Legend (15). The legend is located in the lower left margin. It illustrates and identifies the topographic symbols used to depict some of the more prominent features on the map. The symbols are not always the same on every map. To avoid error in the interpretation of symbols, the legend must always be referred to when a map is read.

(16) Declination Diagram (16). The declination diagram is usually located in the lower margin of large-scale maps and indicates the angular relationships of true north, grid north, and magnetic north. On maps at 1:250,000 scale, this information is expressed as a note in the lower margin.

(17) User's Note (17). A user's note is in the center of the lower margin. It requests cooperation in correcting errors or omissions on the map. Errors should be marked and the map forwarded to the agency identified in the note.

(18) Unit Imprint (18). The unit imprint, in the lower left margin, identifies the agency which printed the map and the printing date. The printing date should

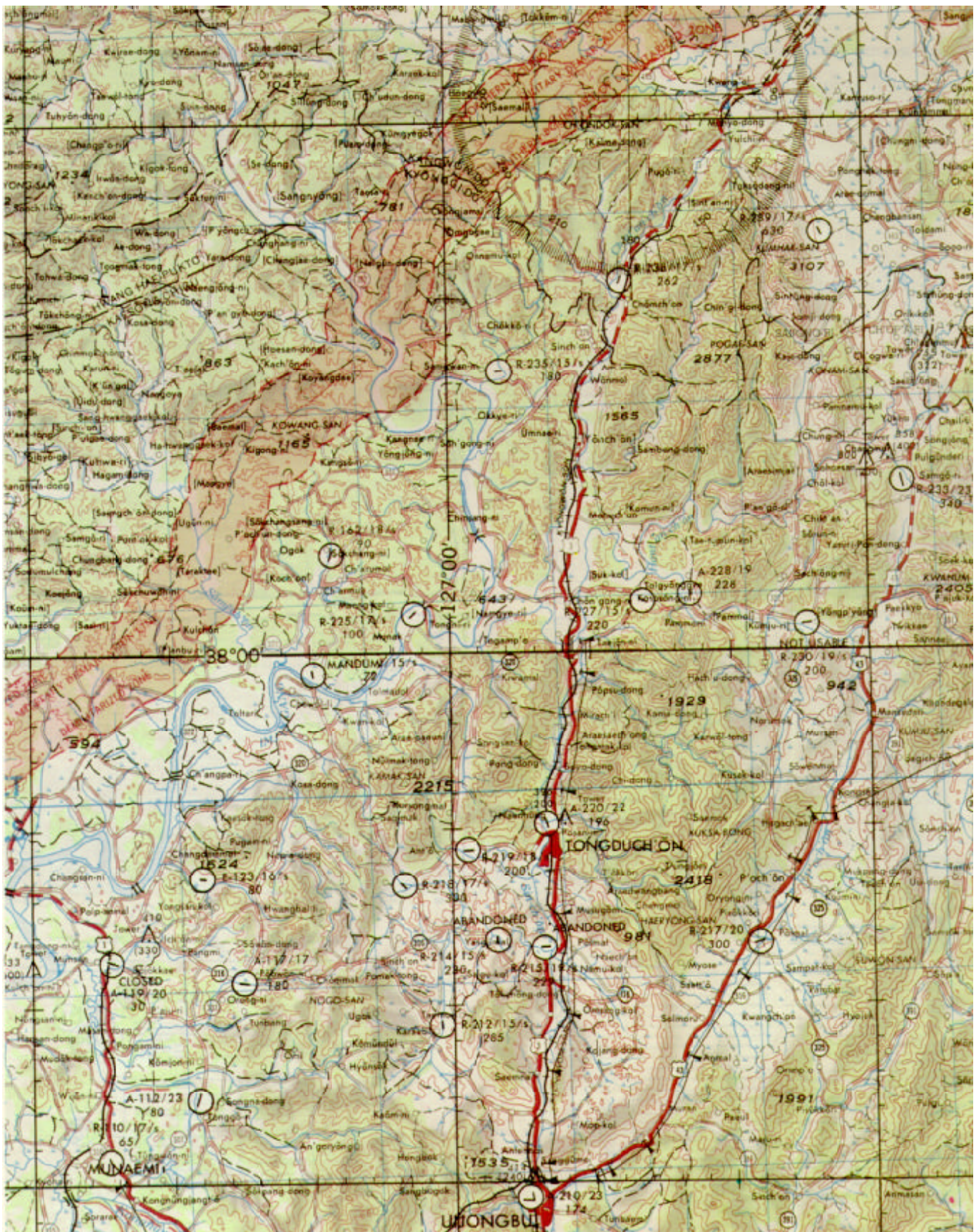

Figure 20-12. DOD Evasion Chart.



Figure 20-13. 1:50,000 Topographic Map.



Figure 20-13. 1:50,000 Topographic Map. (continued)



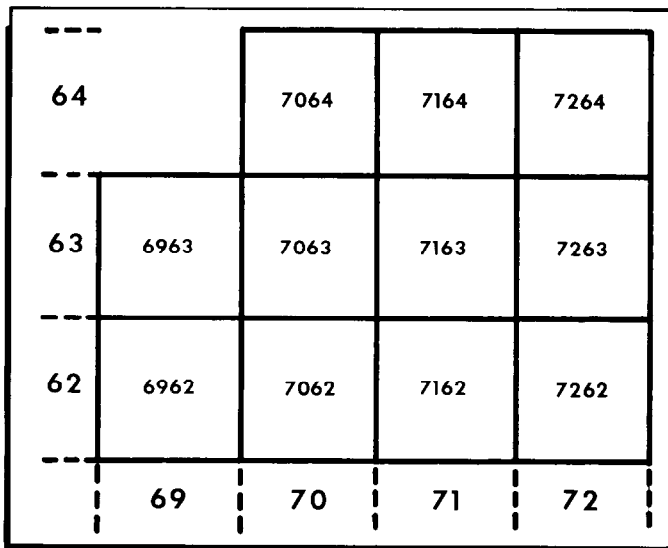

Figure 20-14. Basic Development, 1:100,000 Scale.

not be used to determine when the map information was obtained.

(19) Contour Interval (19). The contour interval note appears in the center of the lower margin. It states the vertical distance between adjacent contour lines on the map. When supplementary contours are used, the interval is indicated.

(20) Special Notes and Scales (20). Under certain conditions, special notes or scales may be added to the margin information to aid the map user. The following are examples:

(a) Glossary. A glossary is an explanation of technical terms or a translation of terms on maps of foreign areas where the native language is other than English.

(b) Classification. Certain maps require a note indicating the security classification. This is shown in the upper and lower margins.

(c) Protractor Scale. A protractor scale may appear in the upper margin on some maps. It is used to lay out the magnetic grid declination of the map which, in turn, is used to orient the map sheet with the aid of a magnetic compass.

(d) Coverage Diagram. A coverage diagram may be used on maps at scales of 1:100,000 and larger. It is normally in the lower or right margin and indicates the methods by which the map was made, dates of photography, and reliability of the sources. On maps at 1:250,000 scale, the coverage diagram is replaced by a reliability diagram.

(e) Elevation Guide. On some maps at scales of 1:100,000 and larger, a miniature characterization of the terrain is shown by a diagram in the lower right margin of the map. The terrain is represented by bands of elevation, spot elevations, and major drainage fea-

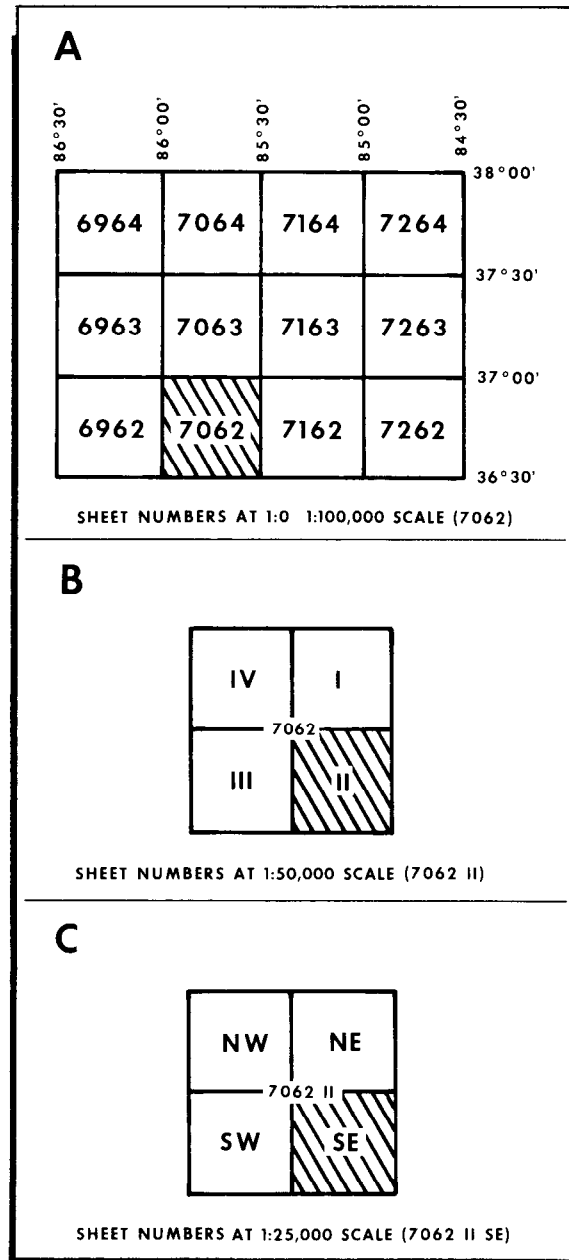
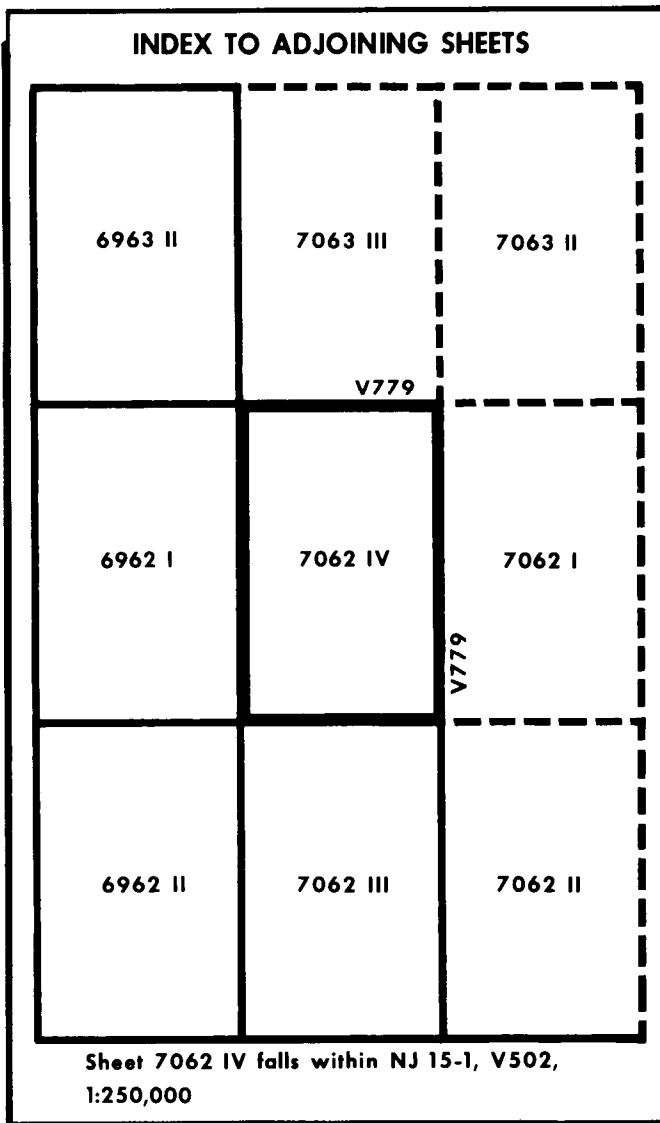

Figure 20-15. Systems for Numbering Maps.

tures. The elevation guide provides the map reader with a means of rapid recognition of major landforms.

(f) Special Notes. A special note is any statement of general information that relates specifically to the mapped area. For example, rice fields are generally subject to flooding; however, they may be seasonally dry.

(21) Stock Number Identification (21). All maps published by or for the Department of the Army or Defense Mapping Agency contain stock number identifications which are used in requisitioning map supplies. The identification consists of the words "STOCK NO." followed by a unique designation which is composed of the series number, the sheet number of the individual



**Figure 20-16. Index to Adjoining Sheets.**

map, and on recently printed sheets, the edition number.

### 20-5. Topographic Map Symbols and Colors:

a. The purpose of a map is to permit one to visualize an area of the Earth's surface with pertinent features properly positioned. Ideally, all the features within an area would appear on the map in their true proportion, position, and shape. This, however, is not practical because many of the features would be unimportant and others would be unrecognizable because of their reduction in size. The mapmaker has been forced to use symbols to represent the natural and manmade features of the Earth's surface. These symbols resemble, as closely as possible, the actual features as viewed from above (figures 20-17 and 20-18).

b. To facilitate identification of features on the map by providing more natural appearance and contrast, the topographic symbols are usually printed in different colors, with each color identifying a class of features. The colors vary with different types of maps, but on a standard large-scale topographic map, the colors used and the features represented are:

(1) Black—the majority of cultural or manmade features.

(2) Blue—water features such as lakes, rivers, and swamps.

(3) Green—vegetation such as woods, orchards, and vineyards.

(4) Brown—all relief features such as contours.

(5) Red—main roads, built-up areas, and special features.

(6) Occasionally, other colors may be used to show special information. (These, as a rule, are indicated in the marginal information. For example, aeronautical symbols and related information for air-ground operations are shown in purple on JOGs.)

c. In the process of making a map, everything must be reduced from its size on the ground to the size which appears on the map. For purposes of clarity, this requires some of the symbols to be exaggerated. They are positioned so that the center of the symbol remains in its true location. An exception to this would be the position of a feature adjacent to a major road. If the width of the road has been exaggerated, then the feature is moved from its true position to preserve its relation to the road.

d. Army Field Manual 21-31 gives a description of topographic symbols and abbreviations authorized for use on US military maps. Figure 20-19 illustrates several of the symbols used on maps.

**20-6. Coordinate Systems.** The intersections of reference lines help to locate specific points on the Earth's surface. Three of the primary reference line systems are the geographic coordinate system, the reference (GEOREF) system, and the universal transverse mercator grid system (UTM). Knowing how to use these plotting systems should help a survivor to determine point locations.

**a. Coordinates.** Quantities that give position with respect to two reference lines are called coordinates. Thus, the intersection of F Street and 4th Avenue (figure 20-20) is the coordinate location of the Gridville Public Library. The coordinates of the local theater are D Street and 6th Avenue. One can see from this simplified example that coordinates are read at intersections of vertical and horizontal lines. The basic coordinate system used on maps and charts is the geographic military grid. The structure and use of the geographic coordinate system, the world geographic reference system, and the military grid reference system will be discussed and illustrated.

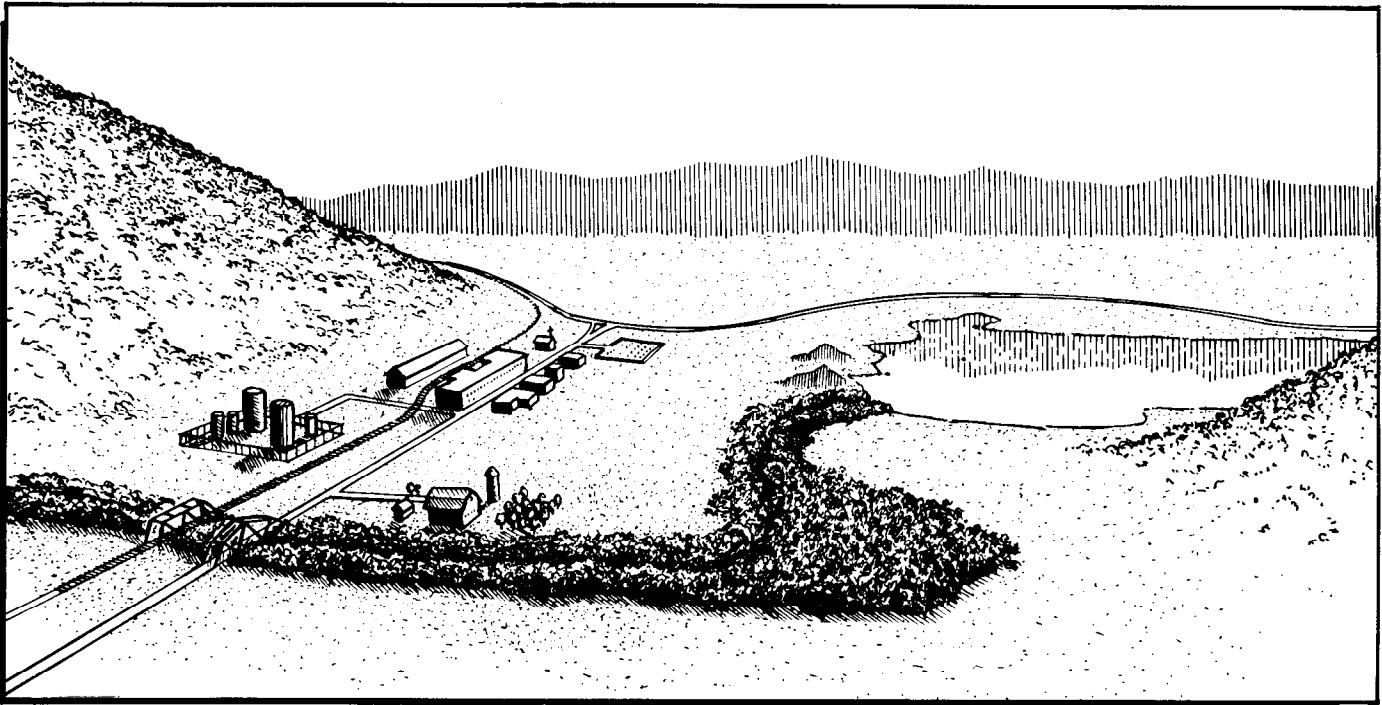

**Figure 20-17. Area Viewed from Ground Position.**

(1) Geographic Coordinates. The geographic coordinate system is a network of imaginary lines that circle the Earth. They are used to express Earth position or

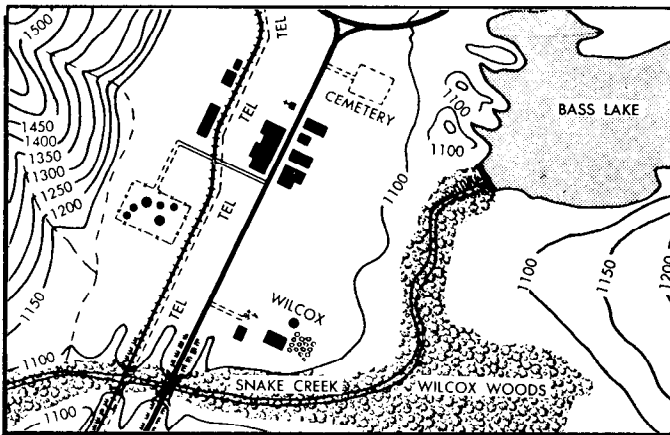

**Figure 20-18. Area Viewed from Ground Position—Map.**

location. There are north-south lines called meridians of longitude and east-west lines named parallels of latitude. The location of any point on the Earth can be expressed in terms of the intersection of the line of latitude and the line of longitude passing through the point.

(2) Meridians of Longitude. The lines of latitude and longitude are actually great and small circles

formed by imaginary planes cutting the Earth. A great circle divides the Earth into two equal parts (halves); whereas, a small circle divides the Earth into two unequal parts. Study figure 20-21 and note that: (1) each north-south line is a great circle, and (2) each great circle passes through both the North and South Poles. Each half of each of these great circles from one pole, in either direction, to the other pole is called a meridian of longitude. The other half of the same great circle is a second meridian of longitude.

(a). Meridian is derived from the Latin word "meridianum," which means "lines that pass through the highest point on their course" (in this case, both the North and South Poles). Any angular distance measured east or west of the meridian is called longitudinal distance; hence, the term "meridian of longitude." It is necessary, of course, to assign values to the meridians to make them meaningful. The most appropriate values to use for circles are degrees ( $^{\circ}$ ), minutes ( $'$ ), and seconds ( $''$ ). Circles are customarily divided into  $360^{\circ}$  per circle,  $60'$  per degree, and  $60''$  per minute.

(b). All meridians are equal in value; hence, one of them must be assigned the value of  $0^{\circ}$  (the starting point). The meridian passing through Greenwich, England, is zero degrees ( $0^{\circ}$ ). This meridian is also called the prime meridian (figure 20-22). The other half of the great circle on which the prime meridian is located is designated the 180th meridian. Portions of this meridian are also called the international dateline.

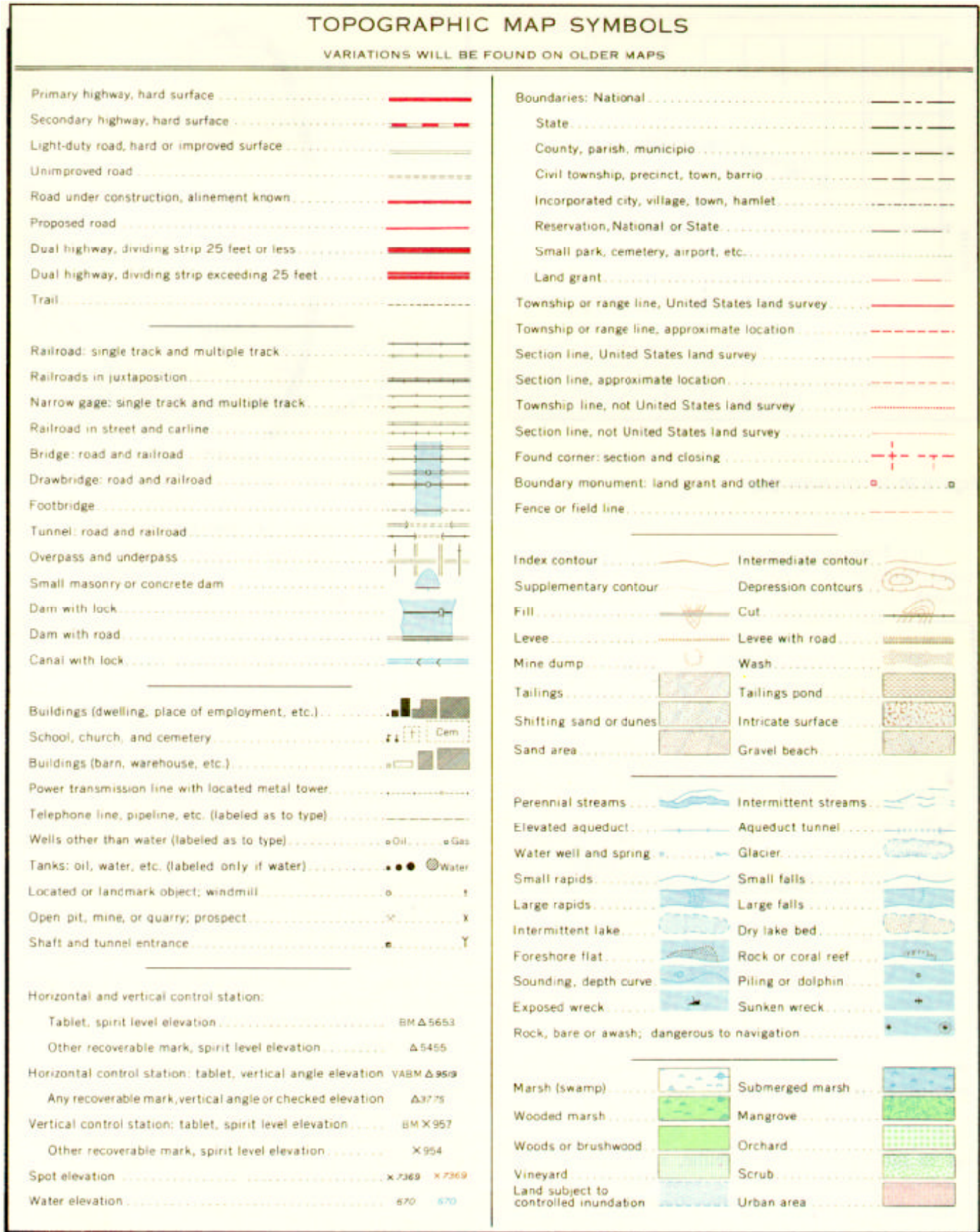

Figure 20-19. Topographic Map Symbols.

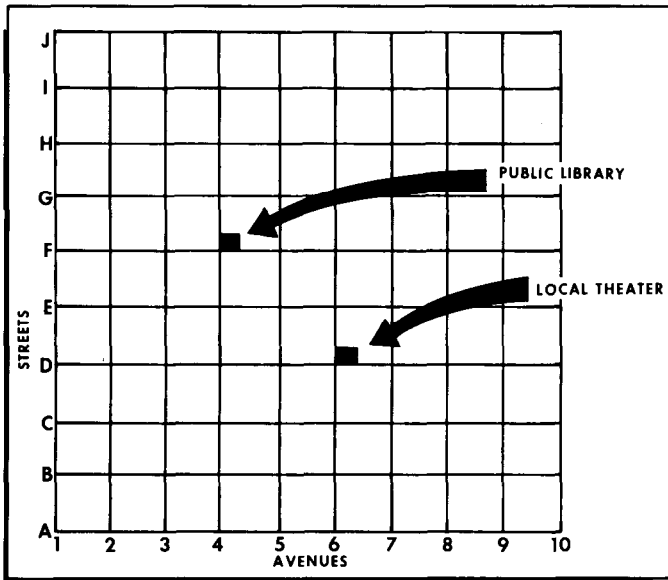

Figure 20-20. Gridville City.

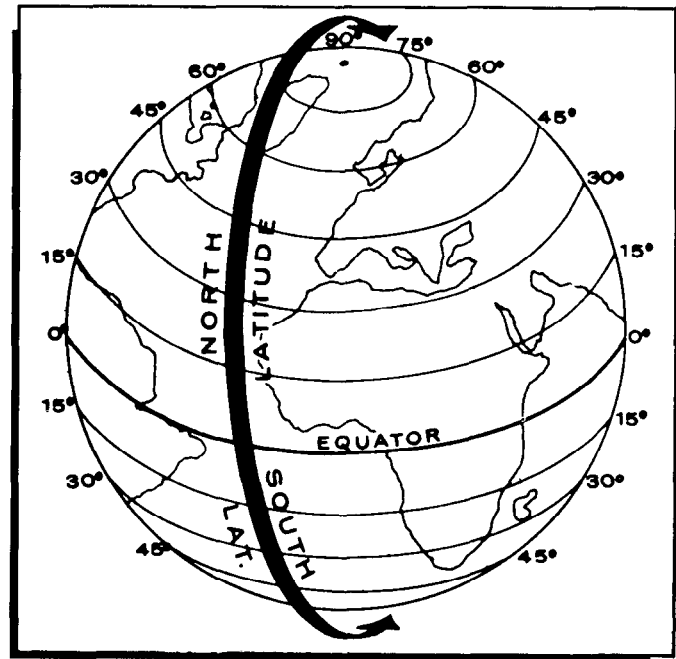

Figure 20-22. Parallels of Latitude.

(c). From the prime meridian east of the international dateline, meridians are assigned values of 0° through 180° east. Similarly, from the prime meridian

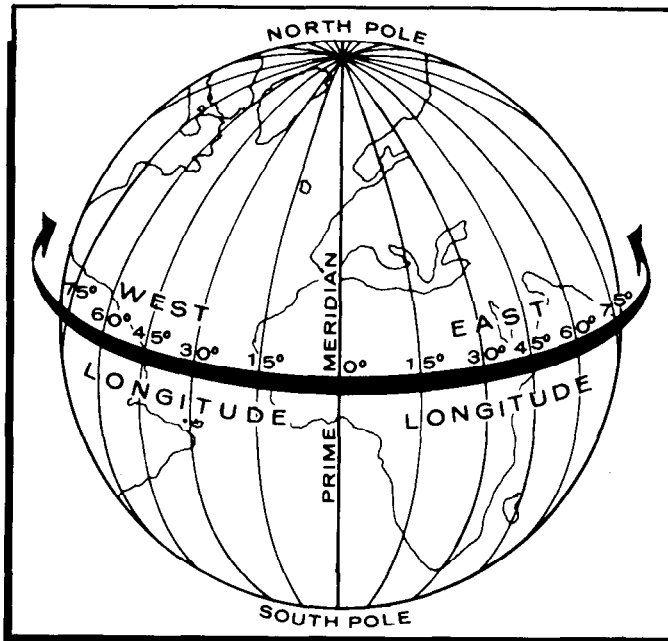

Figure 20-21. Meridian of Longitude.

west to the international dateline, meridians are assigned values of 0° through 180° west. The 0° meridian together with the 180° meridian forms a great circle which divides the Earth into east and west longitude (or hemispheres). There are 180° of east longitude plus 180° of west longitude for 360° of longitude.

**b. Parallels of Latitude.** Notice in figure 20-22 that the circles running in an east-west direction are of varying diameters (sizes). Only the circle designated "Equator" is a great circle. All others are small circles. Note that all circles are parallel to the Equator and run laterally around the Earth. Hence, each circle is called a parallel of latitude. Unlike meridians, which extend only halfway around the Earth, a parallel of latitude extends all the way around the Earth; for the record, the Equator is also a parallel of latitude. Since the Equator is the only great circle of latitude, it is a natural starting point for the 0° value of latitude. The North and South Poles are designated 90° north latitude and 90° south latitude, respectively. Parallels between the Equator and North Pole carry values between 0° and 90° north; parallels between the Equator and the South Pole are assigned values between 0° and 90° south.

(1) Figure 20-23 combines the lines of latitude and longitude. Lines 0° through 90° north or south latitude and 0° through 180° east or west longitude form the grid of the geographic coordinate system. Study the positions of Points A and B in figure 20-23. Determine the geographic coordinates of each in degrees. Note that point A is positioned 32° north of the Equator and 35° east of the prime meridian. The geographic position of point A, therefore, is 32° north 35° east. Point B is located 25° south of the Equator and 40° west of the prime meridian. Hence, the geographic position of point B is 25° south 40° west.

(2) Just as any point within the city of Gridville (figure 20-20) can be referenced by the intersection of

two imaginary lines, any point on the Earth's surface can be referenced by the intersection of the imaginary lines of latitude and longitude.

**c. Writing Geographic Coordinates.** To illustrate the proper way to write geographic coordinates, let's assume that a person needs to write the coordinates of a target. The target is located 30°20' north of the Equator and 135°06' east of the prime meridian. Thus, the position is located at 30°20' north latitude and 135°06' east longitude. By combining latitude and longitude, the position of the geographic location can be expressed as 30°20'N 135°06'E. To write these coordinates in the correct military form, eliminate the degree (°) and minute (') symbols. Thus, the coordinates would be written 302000N1350600E.

(1) Writing geographic coordinates in the military form is necessary for wire and radio transmission of geographic coordinates. Why? The transmission equipment does not include the degree (°), minute ('), and second (") characters in its keyboards. Coordinates are also stored in automated data processing computers which are programmed to handle coordinates in military characters or spaces. If the sequence of numbers and letters fed into a computer is less than 15 spaces, or in error, the resulting printout will be meaningless.

(2) When a position is located that is less than 10° latitude, a zero is added to the left of the degree number. For example, 7° of latitude is written as 07. Likewise, two digits always designate minutes and two digits for seconds. Thus, 7°N becomes 07N; 7°6'N becomes 0706N; and 7°6'5"N becomes 070605N. In expressing longitude, three digits are required to indicate degrees, two digits for minutes, and two digits for seconds. Thus

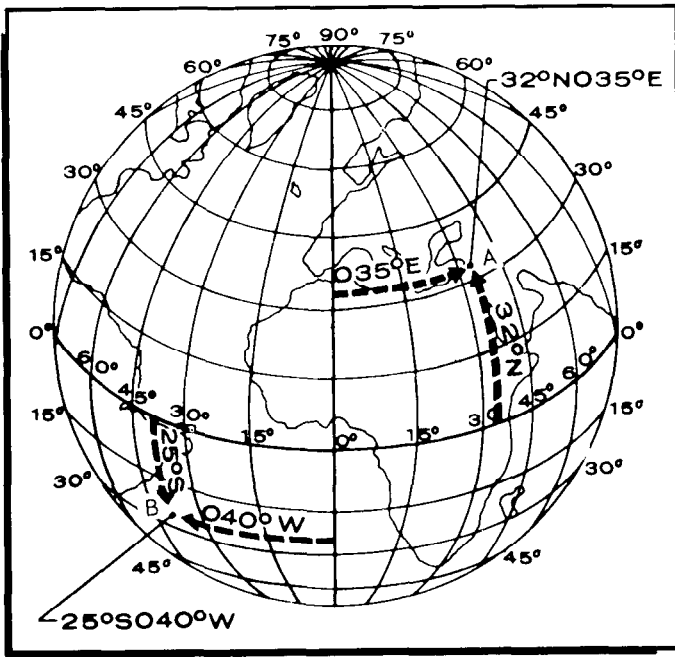

Figure 20-23. Latitudes and Longitudes.

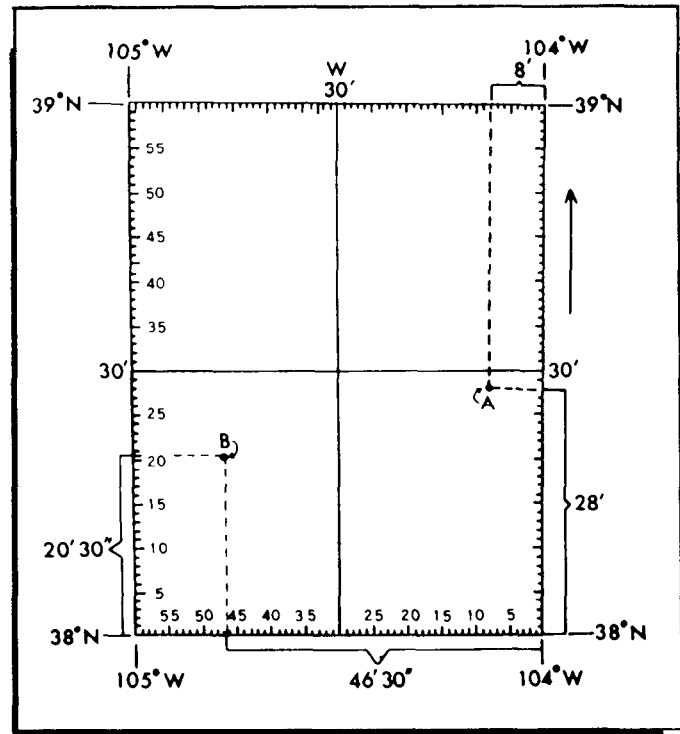

Figure 20-24. Plotting Geographic Coordinates.

8°E becomes 008E; 8°5'E becomes 00805E; and 8°5'4"E becomes 0080504E.

(3) In general, there are five rules to follow in correctly writing geographic coordinates:

- (a) Write latitude first, followed by longitude.
- (b) Use an even number of digits for latitude and an odd number of digits for longitude.
- (c) Do not use a dash or leave a space between latitude and longitude.
- (d) Use single upper case letter to indicate direction from the Equator and prime meridians.
- (e) Omit the symbols for degrees, minutes, and seconds.

**d. Plotting Geographic Coordinates:**

(1) One can probably read the coordinates of point A and B in figure 20-24 rather easily; however, plotting points on maps from given coordinates must also be done. To do this, first get acquainted with the map being used. Assume that figure 20-24 is the map being used. Note that it covers an area from 38N to 39N and from 104W to 105W, an area of 1° by 1°. Also note that latitude and longitude are subdivided by 30' division lines and then with tick marks into 5- and 1-minute subdivisions.

(2) Assume that the coordinates of the point which must be plotted are 382800N1040800W. Next, follow the general procedure listed below to plot the point on the map:

- (a) Locate the parallel of latitude for degrees (38°N).

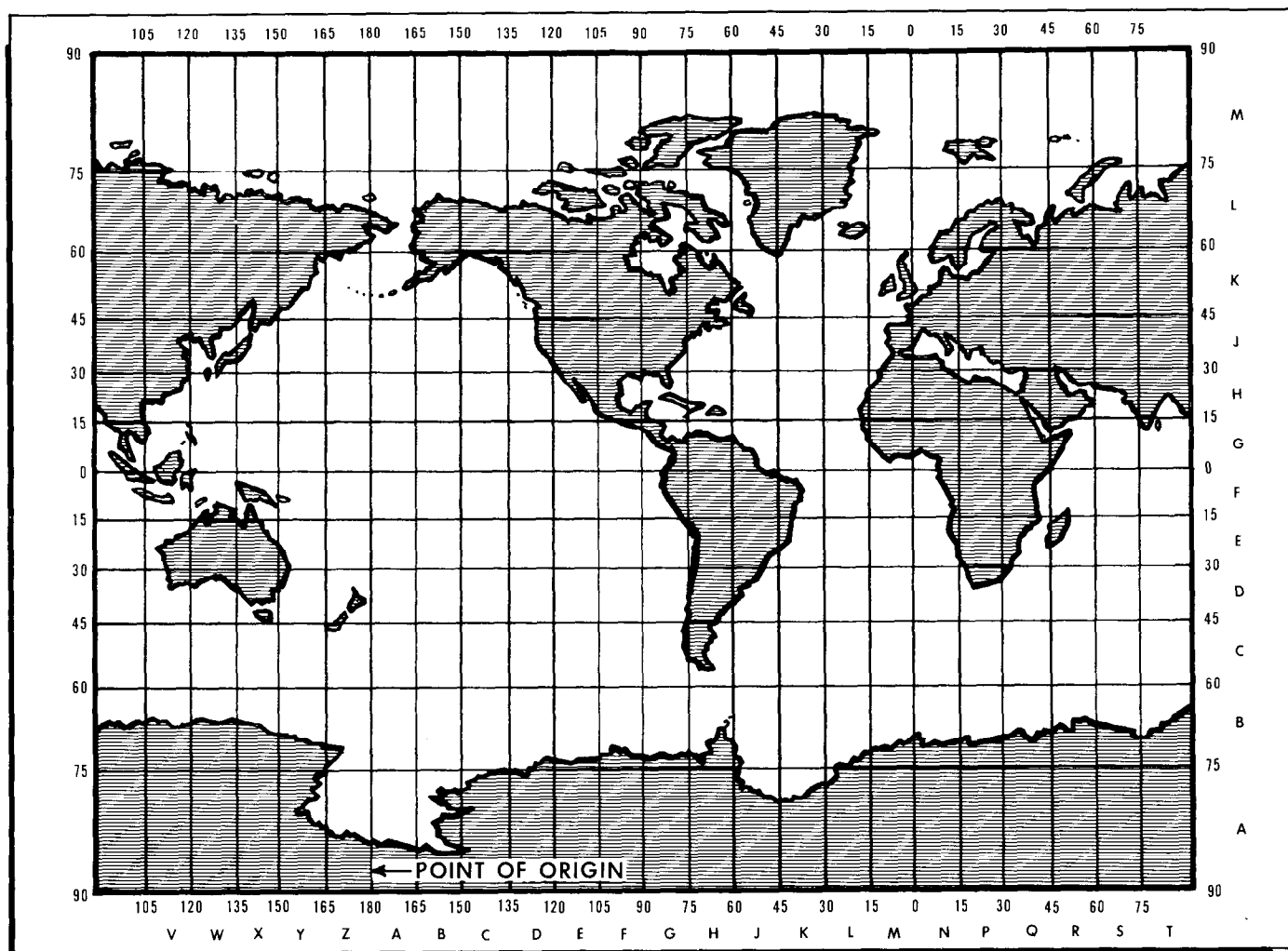

Figure 20-25. GEOREF 15-Degree Quadrants.

(b) Find the meridian of longitude for degrees ( $104^{\circ}\text{W}$ ).

(c) Move to the meridian (usually a tick mark) for minutes ( $08^{\circ}\text{W}$ ).

(d) Move to the parallel (usually a tick mark) for minutes ( $28^{\circ}\text{N}$ ).

(e) Plot the point on the map (point A in figure 20-24; plot at  $382800\text{N}1040800\text{W}$ ).

(3) Recovery points, rally points, and destination positions may be plotted or identified on a map or chart to enable rescue personnel, the survivors, and evaders to locate these positions. Seconds are not shown between the 1-minute tick marks on maps and charts; they must be estimated. It is easy to estimate halfway tick marks (30 seconds); one-fourth (15 seconds) and three-fourths (45 seconds) are also reasonably easy to estimate. Then, as experience is gained, people will find that on large-scale maps they can estimate the sixths (10 seconds) and eights (about 8 seconds). They cannot, however, accurately estimate to sixths or eights at the scale shown in figure 20-24.

(4) To write geographic coordinates more precisely

than minutes, merely carry the coordinates out to include seconds. In the previous example, the coordinates of a target located  $30^{\circ}20'$  north of the Equator and  $135^{\circ}06'$  east of the prime meridian were written as  $302000\text{N}1350600\text{E}$ . A more exact position of the target might be  $30^{\circ}20'05''\text{N}$  latitude and  $135^{\circ}06'16''\text{E}$  longitude. This more precise position is correctly written as  $302005\text{N}1350616\text{E}$ .

#### e. World Geographic Reference System (GEOREF).

The geographic coordinate system has several shortcomings when it is used in military operations. One objectionable feature is the large number of characters necessary to identify a location. To specify a location within 300 yards, a coordinate reading such as  $241412\text{NO}141512\text{W}$  is necessary, with a total of 15 characters. Another objectionable feature is the diversity of directions used in applying the grid numbering system. Any particular point on a geographic grid can be north and east, north and west, south and east, or south and west. This means there are four different ways to proceed when reading various geographic coordinates.





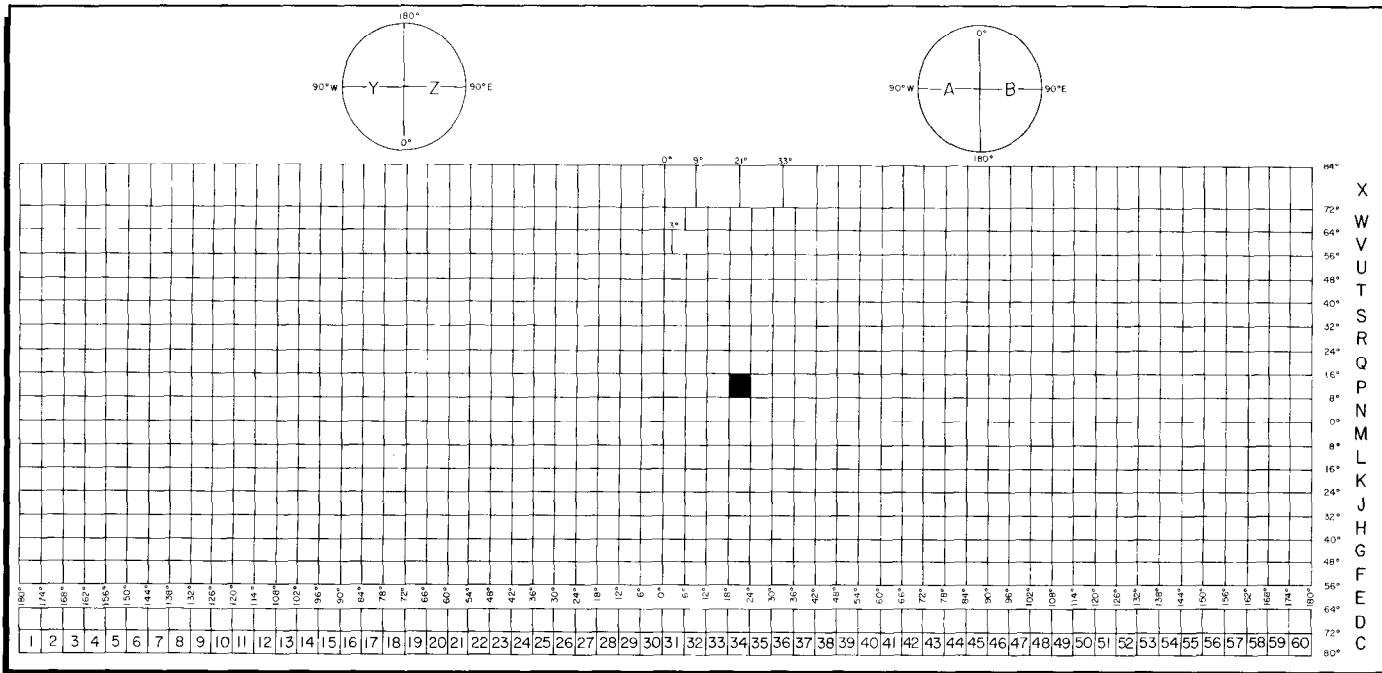

Figure 20-28. UPS Grid Zones.

which it allows a person to designate an area or indicate the elevation of a point. To designate the location and dimensions of a rectangular area, first read the GEOREF coordinates of the southwest corner of the area. Then add an "S," which denotes "side," and digits denoting the number of nautical miles that the area extends to the east. Then add an "X," denoting "by," and digits denoting the number of nautical miles the area extends to the north. An example of such a reference is WGAP2020S10X10 (figure 20-27). Circular areas are designated in much the same manner. First, read the GEOREF coordinates of the center of the area. Then add an "R," denoting radius, and digits defining the radius in nautical miles. This is also illustrated in figure 20-27 as WGAN4550R12.

(4) Military Grid Reference System. A grid is a rectangular coordinate system superimposed on a map. It consists of two sets of equally spaced parallel lines that are mutually perpendicular and form a pattern of squares. Some maps carry more than one grid. In such cases, each grid is shown in a different color or is otherwise distinguished. The military grid reference system is comprised of two grid systems. The US Army adopted the universal transverse mercator (UTM) grid for areas between 80° south latitude and 84° north latitude. For the polar caps, areas below 80° south latitude and above 84° north latitude, the universal polar stereographic (UPS) grid was adopted. The unit of measurement for the UTM and UPS grids are the meter, but the interval at which the grid lines are shown on the maps depends upon the scale.

(5) The UTM Grid System. In the UTM system, the surface of the Earth is divided into large quadrilater-

al grid zones (figure 20-28). Beginning at the 180th meridian, 6° columns are numbered 1 through 60 eastward with each column broken down into rows. From 80° south through 72° north, each row is 8° south-north.

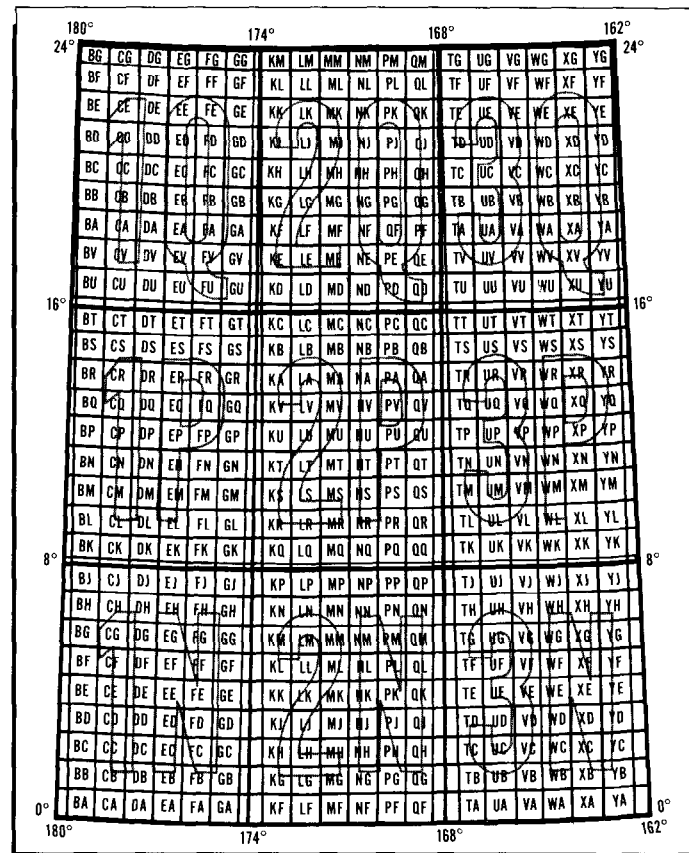

Figure 20-29. UTM Grid Zones.

The top row, 72° to 84° north is 12° south-north. The south-north rows are lettered "C" through "X" (omitting "I" and "O") as shown in figure 20-28. The grid zones are located by reading right and up. For instance, right to column 34 and up to "P" locates grid zone 34P, which is the shaded grid zone of figure 20-28. The UPS grid zones covering the polar areas are designated by a single "A," "B," "Y," or "Z" (figure 20-28).

(a) Each UTM grid zone is divided into columns and rows to form small squares measuring 100,000 meters on each side and are called 100,000-meter squares. Each square is identified with two letters. The columns are lettered "A" through "Z" (omitting "I" and "O"), starting at the 180th meridian and progressing eastward around. The 24 letters are repeated every 18° (figure 20-29). Starting at the Equator, the horizontal row 100,000-meter squares are lettered "A" through "V" (omitting "I" and "O") northward. From the Equator southward, the designation "V" through "A" is used. The letters are repeated periodically (figure 20-29).

(b) The Earth's meridians converge toward the poles. Therefore, the grid zones are not square or rectangular. The actual width of each grid zone decreases toward the poles. This condition causes partial squares

to occur along the grid zones. In the far north and south latitudes, the grid zones become so narrow that 100,000-meter square designations may disappear completely. However, each full or partial 100,000-meter square within a grid zone is referenced with two letters. The first letter refers to the vertical column (left to right), and the second letter identifies the horizontal row (bottom to top). Thus, a grid zone designation plus two letters identifies or designates an area 100,000 meters on each side. Furthermore, as the UTM system is set up, no two squares with the same designation are included in a grid zone or on the same map sheet.

(c) Observe grid zone 34P which is expanded in figure 20-30 to show the 100,000-meter squares. For grid zone 34P, the columns are designated "A" through "H," and the rows are designated "K" through "T" (omitting "O"). The left column begins with "A" because, as stated earlier, columns repeat the alphabet each 18°. The bottom row begins with "K" because "A" through "J" (omitting "I") was used up in the previous 8° of north latitude.

(d) Next, note the partial squares along the left and right sides of grid zone 34P (figure 20-30). Partial squares occur because the distance east and west of the central meridian of each grid zone does not contain an even number of 100,000-meter squares. The last squares, therefore, must terminate at the meridian junctions. In the north-south direction, partial 100,000-meter squares seldom occur.

(e) Figure 20-31 shows the grid reference box for a map or chart. Note the statement in the upper left corner of the grid reference box. It identifies the grid zones that are represented on the map sheet—52S and 53S. Thus, the full UTM coordinates of any point within the map area begins with either 52S or 53S.

(f) Still, it is not clear which area is 52S and which is 53S. Therefore, study the 100,000-meter square block identification located directly below the grid zone designation. From the diagram a person can see that everything to the left of the center meridian is grid zone 52S and everything to the right of the same meridian is 53S.

(g) Other important information given in the grid reference block includes: (1) sample reference and, (2) step-by-step procedures for locating or writing coordinates. Each time a new map is used, identify the sample point and write its UTM coordinates to ensure the grid breakdown for that map is understood.

(h) A troublesome and sometimes confusing situation exists where 100,000-meter squares fuse together along meridians separating grid zones. Remember, this happens every 6° around the world. Notice in figure 20-32 that the 100,000-meter squares GP and KJ are only partial squares, fusing along the center meridian (so are GQ, GN, KH, and KK). There are then full and

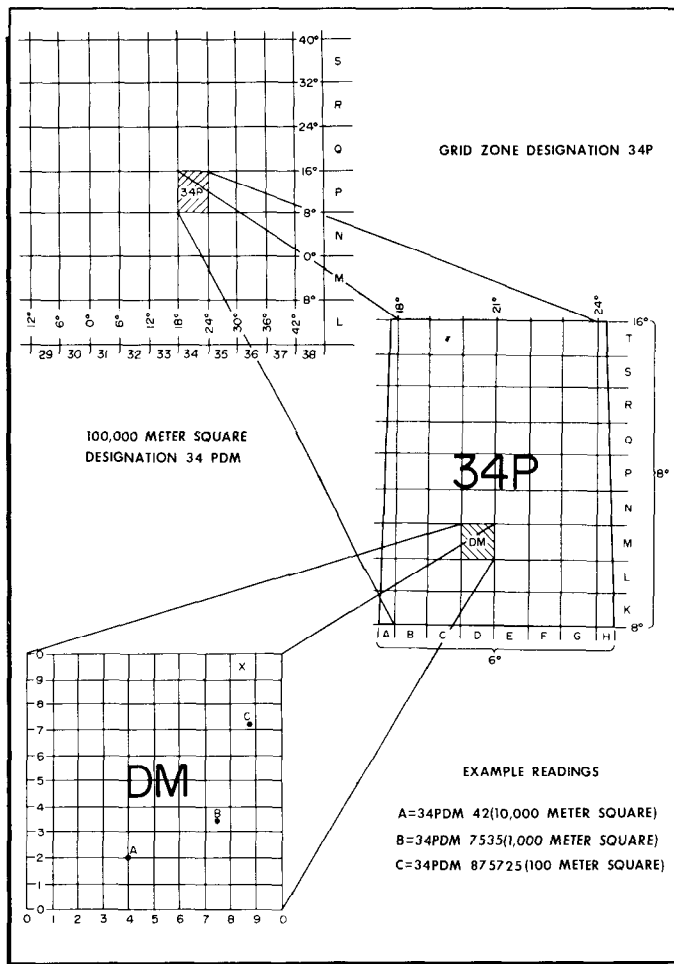

Figure 20-30. Plotting UTM Grid Coordinates.

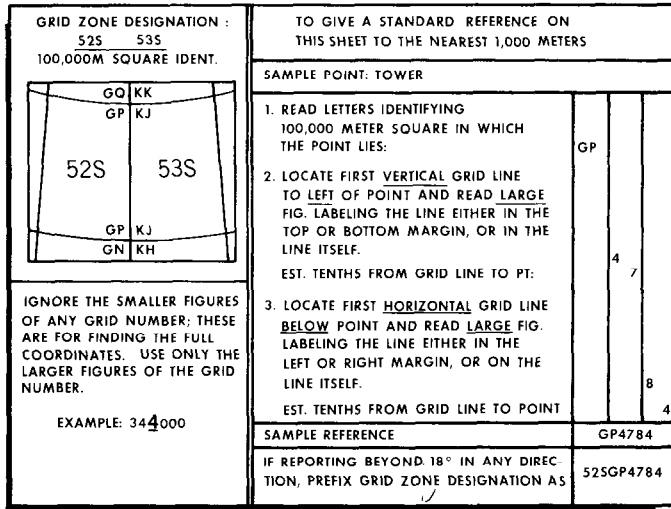

Figure 20-31. UTM Grid Reference Box.

partial 10,000 meter-squares within GP and KJ. Column 7 of the GP is comprised of partial 10,000-meter squares; columns 8 and 9 are missing because of the forced fusing along the meridian; similarly, column 2 of KJ is partial; columns O and I are missing. There is no problem in reading coordinates with full 10,000-meter squares. The tower in GP (sample point in figure 20-32) is 47 right and 84 up (omitting the grid zone and 100,000 meter square designation. All partial 100,000-meter squares are full sized in a north-south dimension). Therefore, distances up are referenced as full squares. However, partial squares, which occur in an east-west dimension, are something less than 10,000 meters long. Points within such partial squares are referenced as if the omitted part were present. That is, each partial square is imaginarily expanded into a full-sized square for reference purposes.

(i) The city of Bergen is 40 up; Celle is 35 up. Celle is three-tenths of the horizontal distance between grid line 7 and grid line 8—if there were a grid line 8. Thus, Celle is 73 right, and its full coordinates are 52SGP7335. Bergen is eight-tenths of the distance (reading left to right) between grid line 2—if there were a grid line 2—and grid line 3. Thus Bergen is 28 right, its full coordinates are 53SKJ2840.

(j) Figure 20-32 depicts a UTM grid breakdown as it normally appears on 1:250,000 scale charts. The smallest physical square is 10,000 meters on each side. However, larger scale maps with grid squares of 1,000 or even 100 meters on each side may be used. If so, add the values for the smaller grid squares. As additional digits are added, more precise points on the Earth's surface can be located.

(6) The UPS Grid System. The UPS reference system is the companion system to the UTM system. It covers the area of the world above 84° north latitude and below 80° south latitude. The UPS has a similar

divisional breakdown and is read or written like the UTM system.

(a) Figure 20-33 shows the arbitrarily assigned designations for the UPS system in the North and South Pole regions. Note that from the small circles of the figure, the polar area is divided into two grid zone divisions by the 180° and 0° meridians. The west longitude half is designated "grid zone A or Y." Also notice that no numbers are used with the letters to identify the grid zones.

(b) The two grid zones "A" and "B" of the South Pole are divided into 100,000-meter squares, as shown in the large circle of figure 20-33. Each square is identified by a two-letter designation, which is assigned so no duplication exists between the two grid zones. The letters "I" and "O" are omitted, and to avoid confusion with 100,000-meter squares in adjoining UTM zones, the letters D, E, M, N, V, and W are also omitted.

(c) The UPS system is also read right and then up. Thus, the shaded 100,000-meter square at 10 o'clock in figure 20-33 is identified as AQR. (Remember, no numbers are used in identifying the grid zone.) The shaded 100,000-meter square near the South Pole of the same drawing is identified as BBM.

(d) The UPS breakdown of the North Pole region is similar to the South Pole region. Conversion of figure 20-33 to fit the North Pole would require the following changes: Substitute grid zone letters "Y" for "A" and "Z" for "B," and interchange the 0° and 180° positions on the common parallel at 80° South latitude. Designation of the 100,000-meter squares for the North Pole region is shown in figure 20-33.

(e) If the map scale is sufficiently large, the 100,000-meter squares can be subdivided into smaller squares of 10,000 meters on each side. Then, the 10,000-meter squares can be divided into 1,000-or even 100-meter squares. However, there is rarely a requirement in the polar regions for such a large-scale chart.

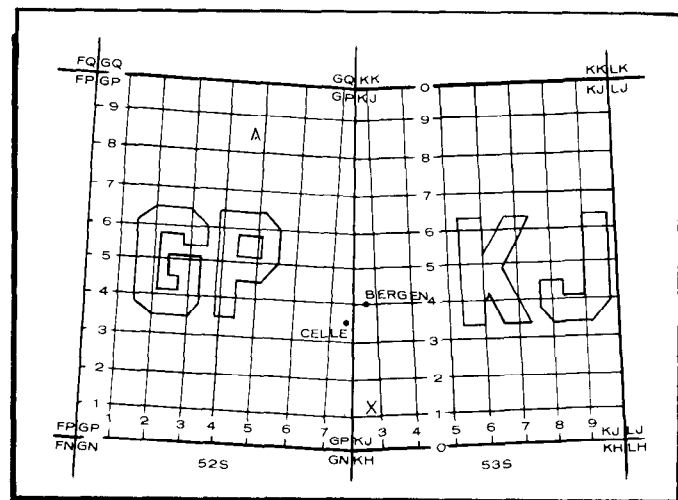

Figure 20-32. Fusion of Grid Zones 52S and 53S.

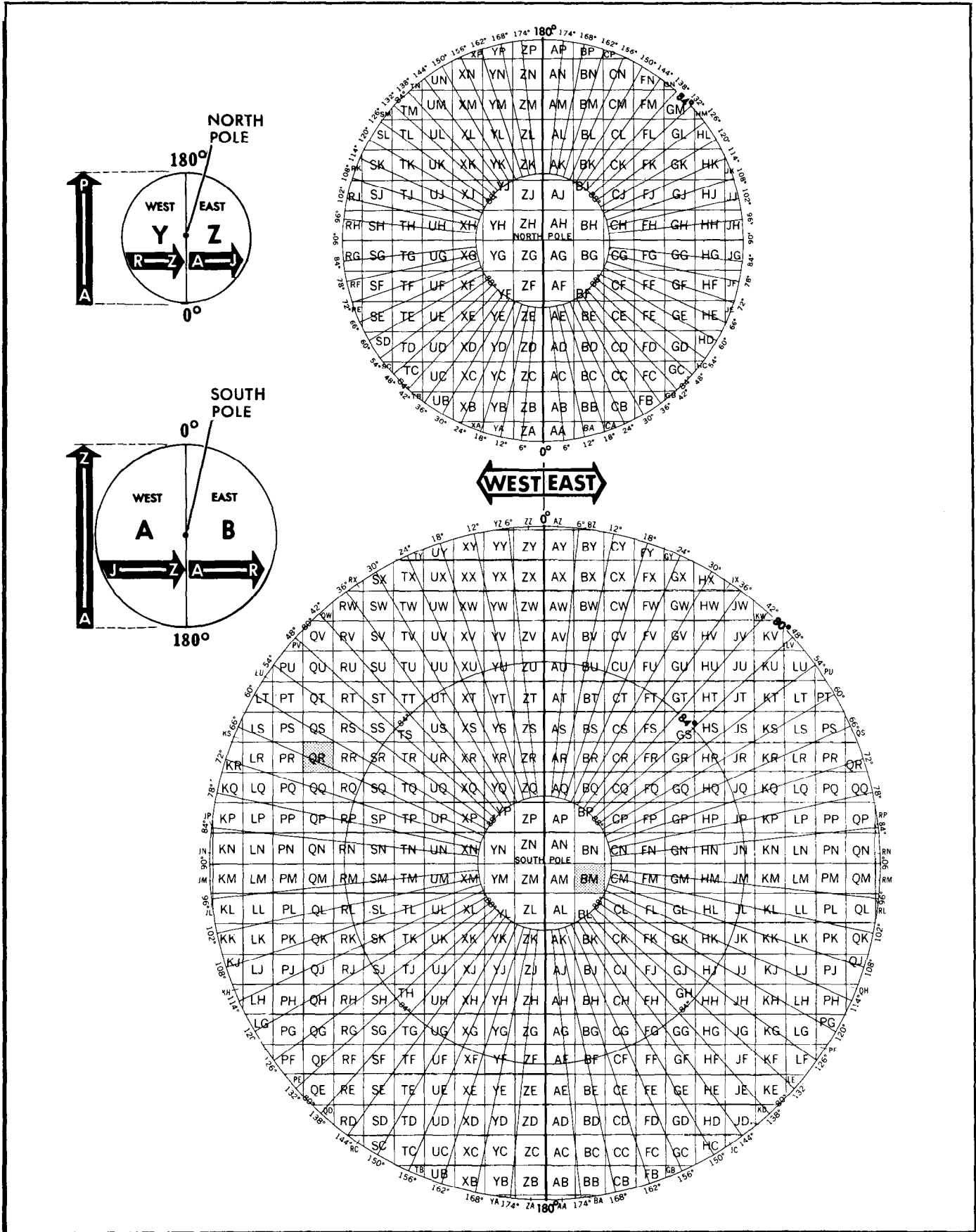

Figure 20-33. UPS Grid Zones.

Generally, a person can expect to work with small-scale charts with the grid broken down no further than 100,000-meter squares.

(7) Public Land Survey. In the western part of the United States or in areas which were not settled before the Federal Government was formed, all land is laid out in rectangular survey as established by the Government. This public land survey is based on all land being divided in relation to true north. Public land surveys all originate from six or seven initial points which are exact locations of even latitude and longitude lines which have been established astronomically.

(a) From any one of the initial points a true north-south line, referred to as the principal meridian, is established. From the same point a true east-west line, referred to as the baseline, is established. Along this principal meridian and baseline are laid out 6-mile squares or townships. Each of these townships are numbered in relation to the initial point of survey. To the east and west of the initial point, the townships are designated by range numbers; to the north and south of the initial point, the townships are designated by township numbers. Therefore, township 2 north, range 3 east, would lie between 6 and 12 miles north of the initial point and between 12 and 18 miles east of the initial point.

(b) Each township contains 36 square miles and is divided into 36 sections. A section is 1 square mile or 640 acres. The section layout on townships is the same throughout the Public Land Survey. The sections are numbered in rows back and forth beginning in the upper right-hand corner of the township and ending in the lower right-hand corner (figure 20-34).

(c) Each section is divided into quarters or quarter sections of 160 acres each. These quarter sections are named by the compass location in relation to the section. The upper right-hand quarter section is referred to as the northeast 1/4, the lower right-hand quarter is the southeast 1/4, the lower left-hand quarter is the southwest 1/4, and the upper left-hand quarter is the northwest 1/4.

(d) Each quarter section is further subdivided into quarters or four blocks of 40 acres each known as forties. The forties are also located by the compass directions. In locating a particular piece of property, the 40-compass quadrant is given first, followed by the quarter section quadrant. Thus the SW-SE means the southwest 40 of the southeast quarter section. This is the basic unit of land management and, therefore, one should become familiar with the Public Land Survey and the means of locating specific pieces of property.

between the two points? The map user must become proficient in recognizing various landforms and irregularities of the Earth's surface and be able to determine the elevation and differences in height of all terrain features.

**a. Datum Plane.** This is the reference used for vertical measurements. The datum plane for most maps is mean or average sea level.

**b. Elevation.** This is defined as the height (vertical distance) of an object above or below a datum plane.

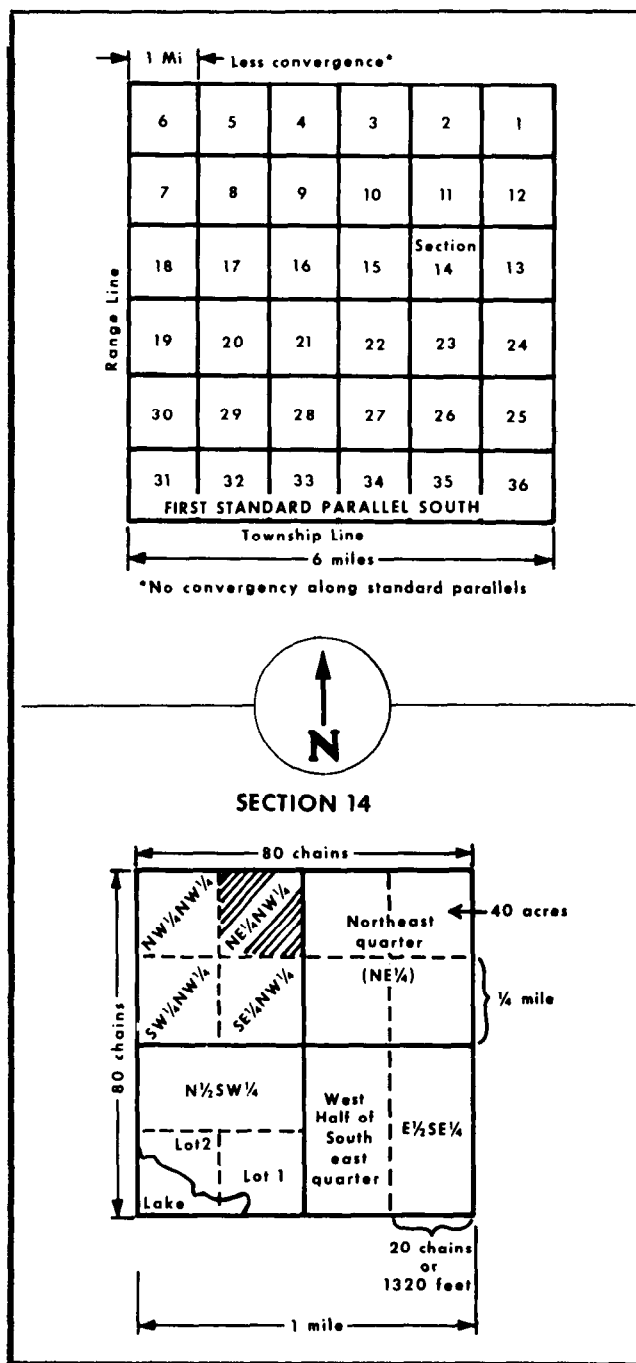

Figure 20-34. Section 14.

**20-7. Elevation and Relief.** A knowledge of map symbols, grids, scale, and distance gives enough information to identify two points, locate them, measure between them, and determine how long it would take to travel between them. But what happens if there is an obstacle

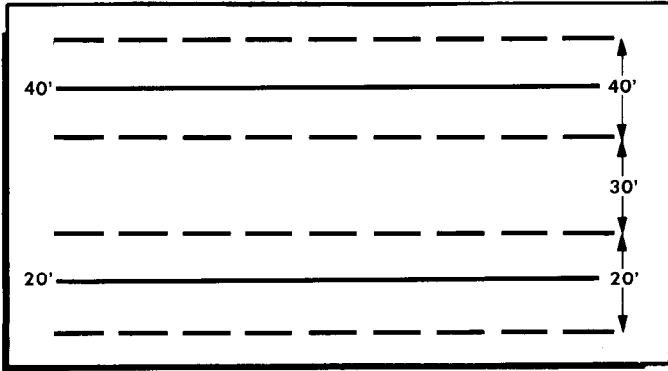

Figure 20-35. Estimating Elevation and Contour Lines

**c. Relief.** Relief is the representation of the shape and height of landforms and characteristic of the Earth's surface.

**d. Contour Lines:**

(1) There are several ways of indicating elevation and relief on maps. The most common way is by contour lines. A contour line is an imaginary line connecting points of equal elevation. Contour lines indicate a vertical distance above or below a datum plane. Starting at sea level, each contour line represents an elevation above sea level. The vertical distance between adjacent contour lines is known as the contour interval. The

amount of contour interval is given in the marginal information. On most maps, the contour lines are printed in brown. Starting at zero elevation, every fifth contour line is drawn with a heavier line. These are known as index contours and somewhere along each index contour, the line is broken and its elevation is given. The contour lines falling between index contours are called intermediate contours. They are drawn with a finer line than the index contours and usually do not have their elevations given.

(2) Using the contour lines on a map, the elevation of any point may be determined by:

(a) Finding the contour interval of the map from the marginal information, and noting the amount and unit of measure.

(b) Finding the numbered contour line (or other given elevation) nearest the point for which elevation is being sought.

(c) Determining the direction of slope from the numbered contour line to the desired point.

(d) Counting the number of contour lines that must be crossed to go from the numbered line to the desired point and noting the direction—up or down. The number of lines crossed multiplied by the contour interval is the distance above or below the starting value. If the desired point is on a contour line, its elevation is that of the contour; for a point between contours,

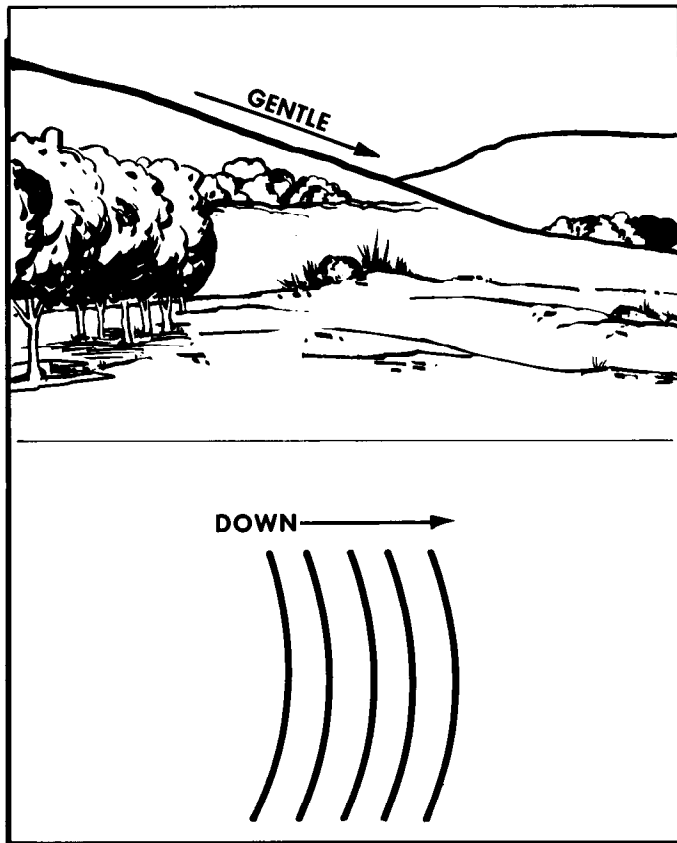

Figure 20-36. Uniform Gentle Slope.

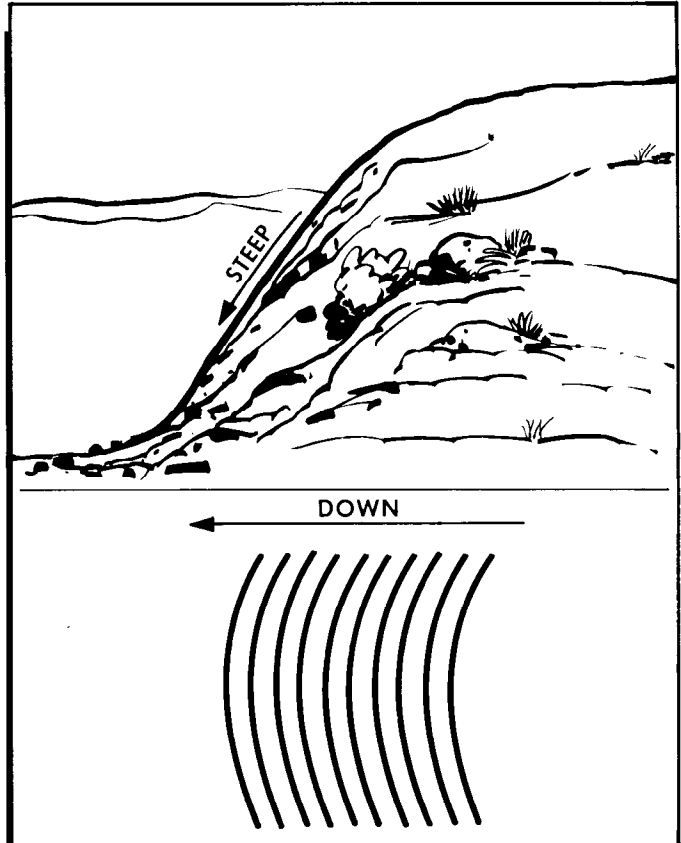

Figure 20-37. Uniform Steep Slope.

most military needs are satisfied by estimating the elevation to an accuracy of one-half the contour interval. All points less than one-fourth the distance between the lines are considered to be at the same elevation as the line. All points one-fourth to three-fourths the distance from the lower line are considered to be at an elevation one-half the contour interval above the lower line (figure 20-35).

(e) To estimate the elevation of the top of an unmarked hill, add half the contour interval to the elevation of the highest contour line around the hill. To estimate the elevation of the bottom of a depression, subtract half the contour interval from the value of the lowest contour around the depression.

(f) On maps where the index and intermediate contour lines do not show the elevation and relief in as much detail as may be needed, supplementary contour may be used. These contour lines are dashed brown lines, usually at one-half the contour interval for the map. A note in the marginal information indicates the interval used. They are used exactly as are the solid contour lines.

(g) On some maps contour lines may not meet the standards of accuracy but are sufficiently accurate in both value and interval to be shown as contour rather than as form lines. In such cases, the contours are considered as approximate and are shown with a dashed symbol; elevation values are given at intervals along the

heavier (index contour) dashed lines. The contour note in the map margin identifies them as approximate contours.

(h) In addition to the contour lines, bench marks and spot elevations are used to indicate points of known elevation on the map. Bench marks, the more accurate of the two, are symbolized by a black X, as X BM 124. The elevation value shown in black refers to the center of the X. Spot elevations shown in brown generally are located at road junctions, on hilltops, and other prominent landforms. The symbol designates an accurate horizontal control point. When a bench mark and a horizontal control point are located at the same point, the symbol BM is used.

(i) The spacing of the contour lines indicates the nature of the slope. Contour lines evenly spaced and wide apart indicate a uniform, gentle slope (figure 20-36). Contour lines evenly spaced and close together indicate a uniform, steep slope. The closer the contour lines to each other, the steeper the slope (figure 20-37). Contour lines closely spaced at the top and widely spaced at the bottom indicate a concave slope (figure 20-38). Contour lines widely spaced at the top and closely spaced at the bottom indicate a convex slope (figure 20-39).

(j) To show the relationship of land formations to each other and how they are symbolized on a contour map, stylized panoramic sketches of the major relief

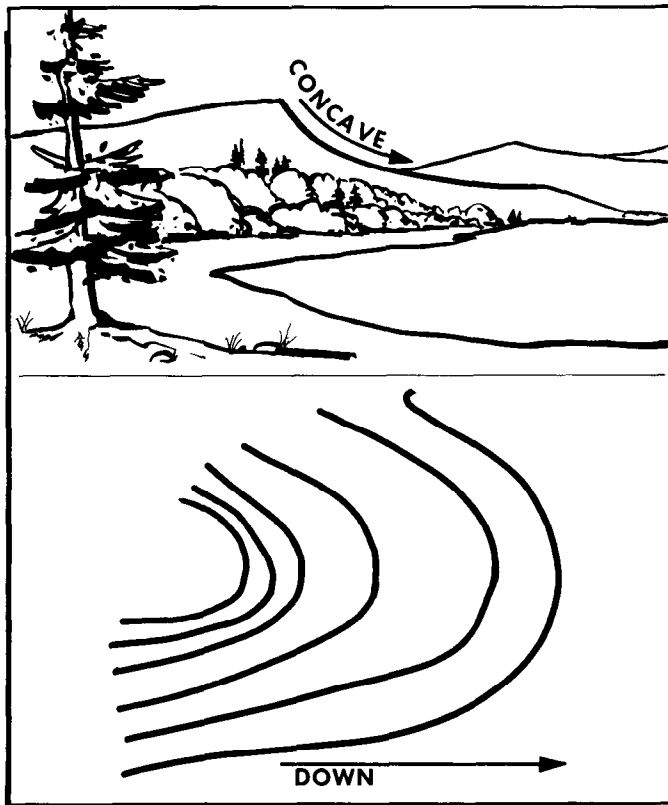

Figure 20-38. Concave Slope.

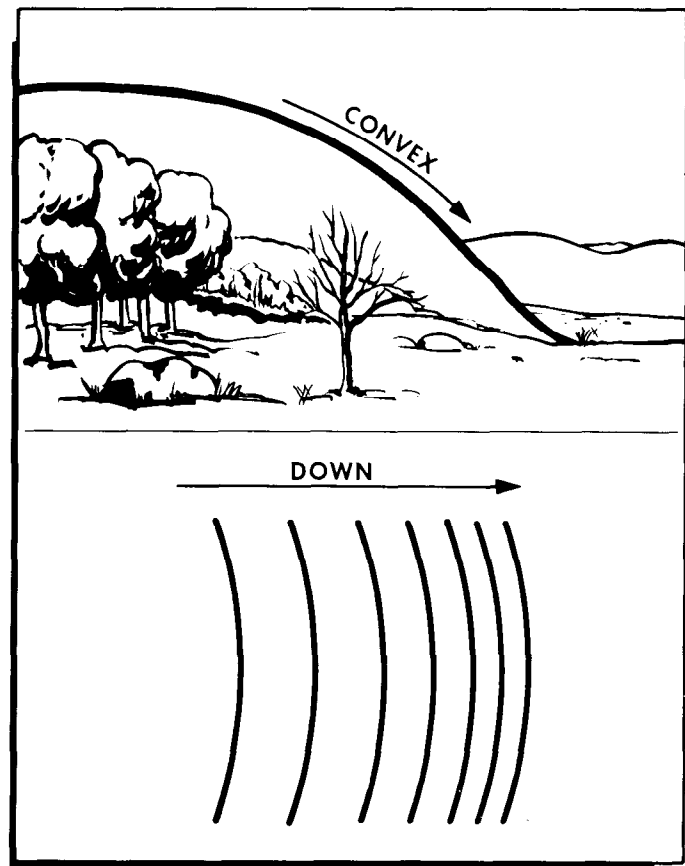

Figure 20-39. Convex Slope.

formations were drawn and a contour map of each sketch developed. Each figure (figure 20-40 through 20-46) shows a sketch and a map with a different relief feature and its characteristic contour pattern.

(3) Hill. A point or small area of high ground (figure 20-40). When one is located on a hilltop, the ground slopes down in all directions.

(4) Valley. Usually a stream course which has at least a limited extent of reasonably level ground bordered on the sides by higher ground (figure 20-41A). The valley generally has maneuvering room within its confines. Contours indicating a valley are U-shaped and tend to parallel a major stream before crossing it. The more gradual the fall of a stream, the farther each contour inner part. The curve of the contour crossing always points upstream.

(5) Drainage. A less-developed stream course in which there is essentially no level ground and, therefore, little or no maneuvering room within its confines (figure 20-41B). The ground slopes upward on each side and toward the head of the drainage. Drainages occur frequently along the sides of ridges, at right angles to the

valleys between the ridges. Contours indicating a drainage are V-shaped, with the point of the "V" toward the head of the drainage.

(6) Ridge. A range of hills or mountains with normally minor variations along its crest (figure 20-42A). The ridge is not simply a line of hills; all points of the ridge crest are appreciably higher than the ground on both sides of the ridge.

(7) Finger Ridge. A ridge or line of elevation projecting from or subordinate to the main body of a mountain or mountain range (figure 20-42B). A finger ridge is often formed by two roughly parallel streams cutting drainages down the side of a ridge.

(8) Saddle. A dip or low point along the crest of a ridge. A saddle is not necessarily the lower ground between two hilltops; it may simply be a dip or break along an otherwise level ridge crest (figure 20-43).

(9) Depression. A low point or sinkhole surrounded on all sides by higher ground (figure 20-44).

(10) Cuts and Fills. Manmade features by which the bed of a road or railroad is graded or leveled off by

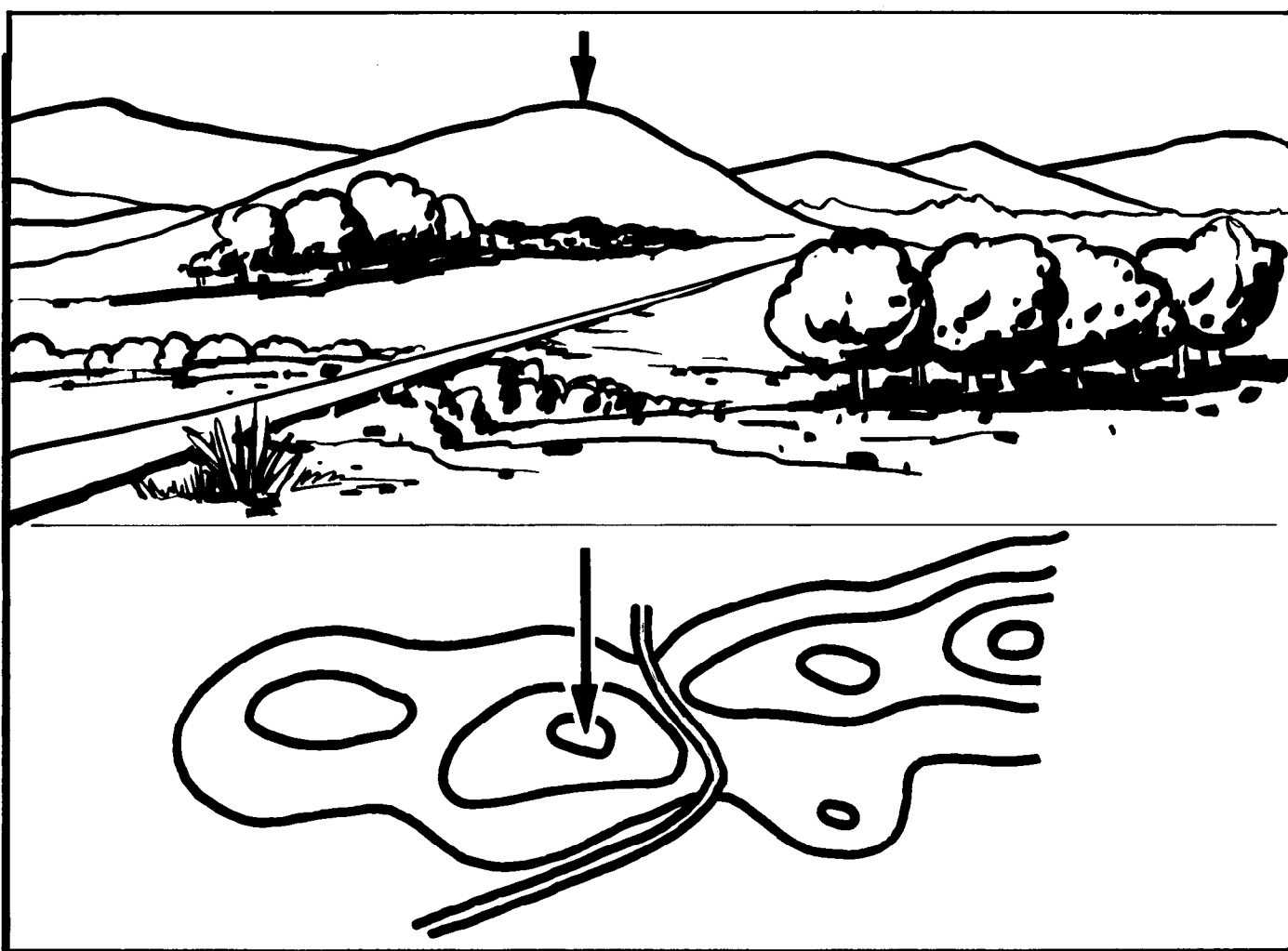

Figure 20-40. Hill.



cutting through high areas (figure 20-45A) and filling in low areas (figure 20-45B) along the right-of-way.

(11) Cliff. A vertical or near vertical slope (figure 20-46). When a slope is so steep that it cannot be shown at the contour interval without the contours fusing, it is shown by a ticked "carrying" contour(s). The ticks always point toward lower ground.

### 20-8. Representative Fraction (RF):

a. The numerical scale of a map expresses the ratio of horizontal distance on the map to the corresponding horizontal distance on the ground. It usually is written as a fraction, called the representative fraction (RF). The representative fraction is always written with the map distance as one (1). It is independent of any unit of measure. An RF of 1/50,000 or 1:50,000 means that one (1) unit of measure on the map is equal to 50,000 of the same units of measure on the ground.

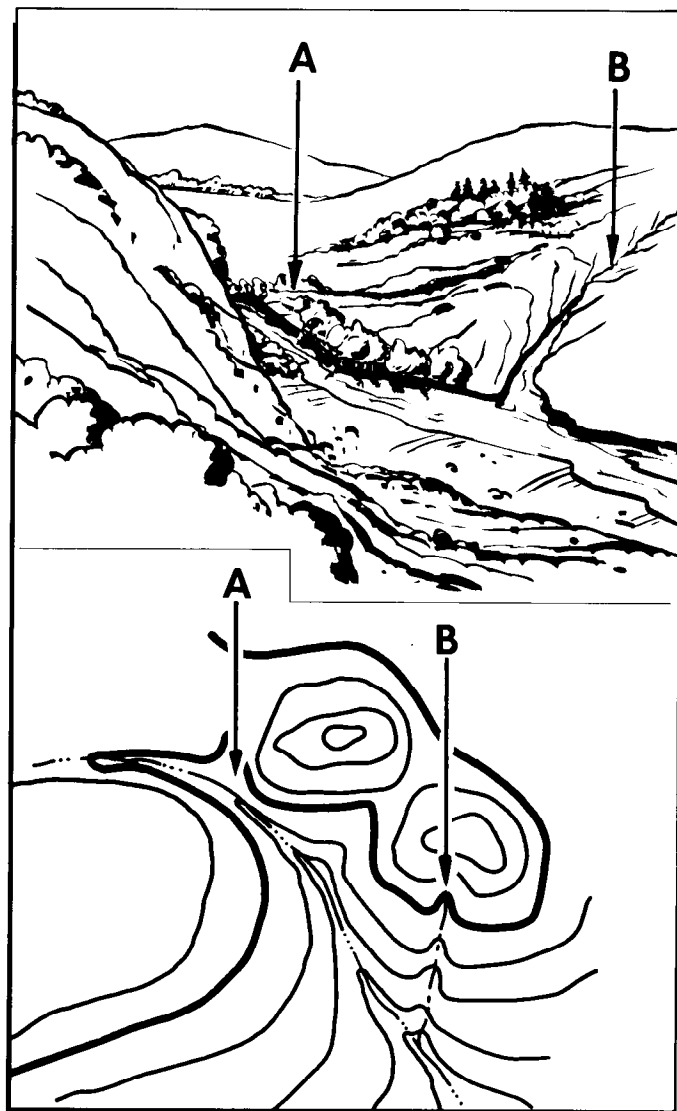

Figure 20-41. (A) Valley (B) Drainage.

b. The ground distance between two points is determined by measuring between the points on the map and multiplying the map measurement by the denominator of the RF.

$$\text{Example: RF} = \frac{1}{50,000} \text{ or } \frac{1}{50,000}$$

$$\begin{aligned} \text{Map distance} &= 5 \text{ units (CM)} \\ 5 \times 50,000 &= 250,000 \text{ units (CM) of} \\ &\text{ground distance (figure 20-47).} \end{aligned}$$

c. When determining ground distance from a map, the scale of the map affects the accuracy. As the scale becomes smaller, the accuracy of measurement decreases because some of the features on the map must be exaggerated so that they may be readily identified.

### 20-9. Graphic (Bar) Scales:

a. On most military maps, there is another method of determining ground distance. It is by means of the graphic (bar) scales. A graphic scale is a ruler printed on the map on which distances on the map may be measured as actual ground distances. To the right of the zero (0), the scale is marked in full units of measure and is called the primary scale. The part to the left of zero (0) is divided into tenths of a unit and is called the extension scale. Most maps have three or more graphic scales, each of which measures distance in a different unit of measure (figure 20-48).

b. To determine a straight-line ground distance between two points on a map, lay a straight-edged piece of paper on the map so that the edge of the paper touches both points. Mark the edge of the paper at each point. Move the paper down to the graphic scale and read the ground distance between the points. Be sure to use the scale that measures in the unit of measure desired (figure 20-49).

c. To measure distance along a winding road, stream, or any other curved line, the straightedge of a piece of paper is used again. Mark one end of the paper and place it at the point from which the curved line is to be measured. Align the edge of the paper along a straight portion and mark both the map and the paper at the end of the aligned portion. Keeping both marks together, place the point of the pencil on the mark on the paper to hold it in place. Pivot the paper until another approximately straight portion is aligned and again mark on the map and the paper. Continue in this manner until measurement is complete. Then place the paper on the graphic scale and read the ground distance (figure 20-50).

d. Often, marginal notes give the road distance from the edge of the map to a town, highway, or junction of the map. If the road distance is desired from a point on the map to such a point off the map, measure the distance to the edge of the map and add the distance speci-

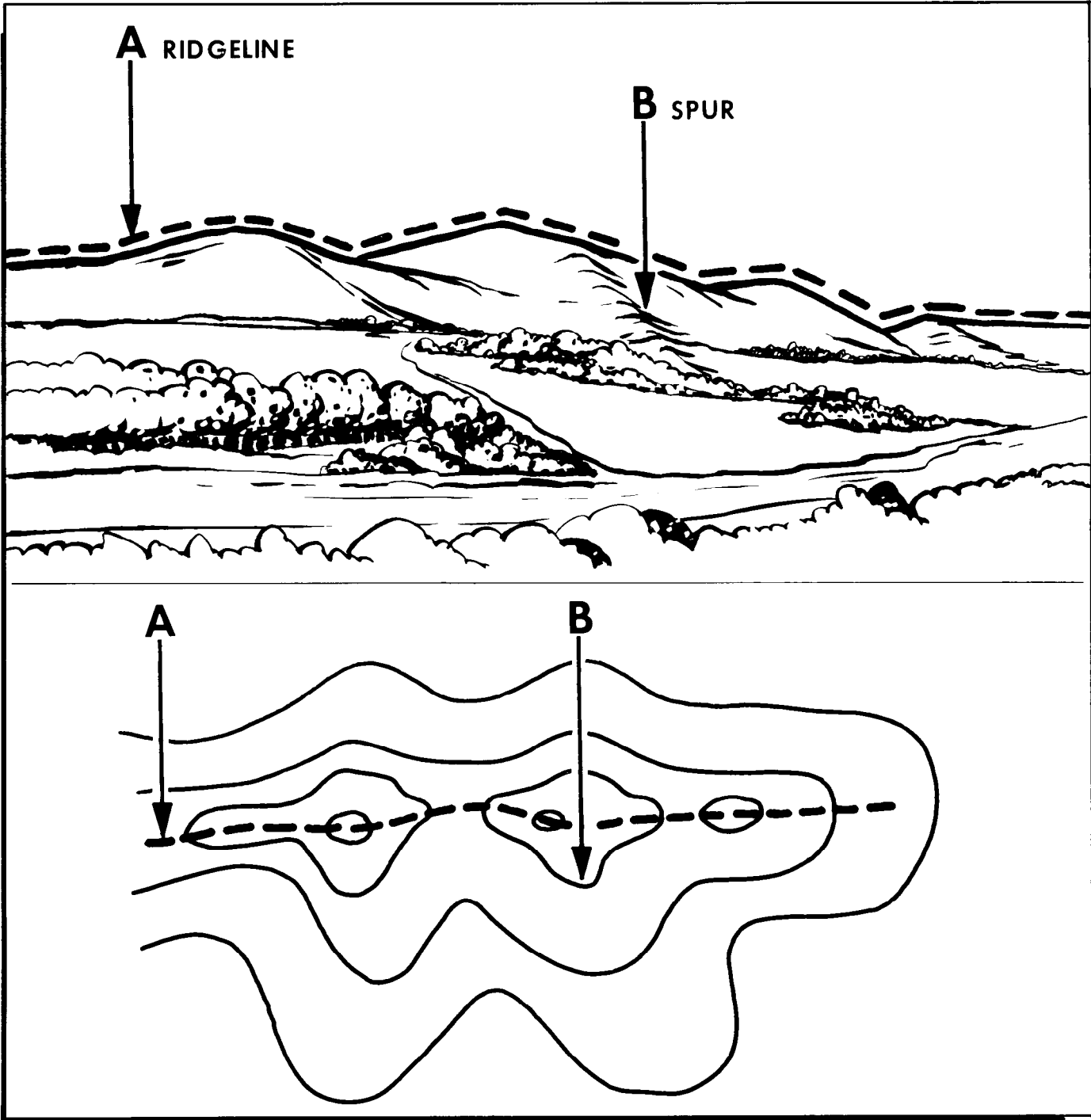

Figure 20-42. (a) Ridge Line (b) Finger Ridge.

fied in the marginal note to that measurement. Be sure the unit of measure is the same (figure 20-51).

**20-10. Using a Map and Compass, and Expressing Direction:**

a. To use a map, the map must correspond to the lay of the land, and the user must have a knowledge of direction and how the map relates to the cardinal directions. In essence, to use a map for land navigation, the

map must be "oriented" to the lay of the land. This is usually done with a compass. On most maps, either a declination diagram, compass rose, and lines of map magnetic variations are provided to inform the user of the difference between magnetic north and true north.

b. Directions are expressed in everyday life as right, left, straight ahead, etc.; but the question arises, "to the right of what?" Military personnel require a method of expressing direction which is accurate, adaptable for use

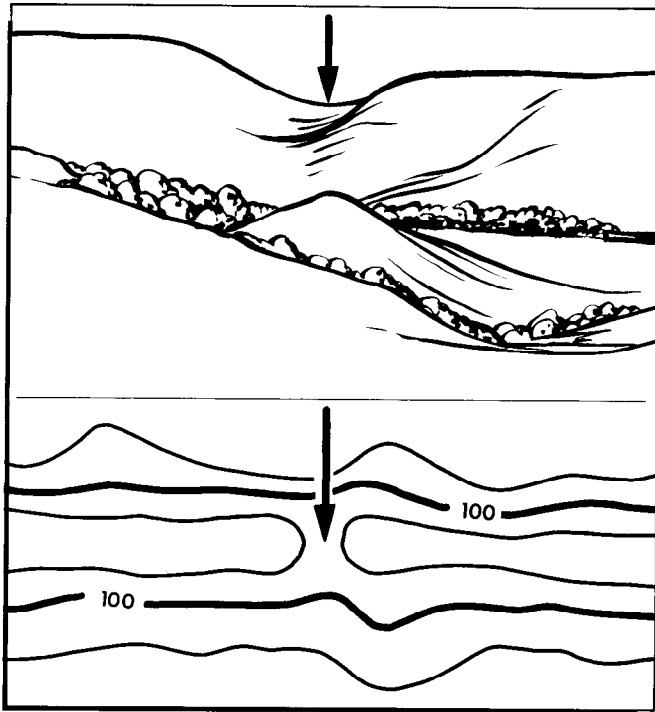

Figure 20-43. Saddle.

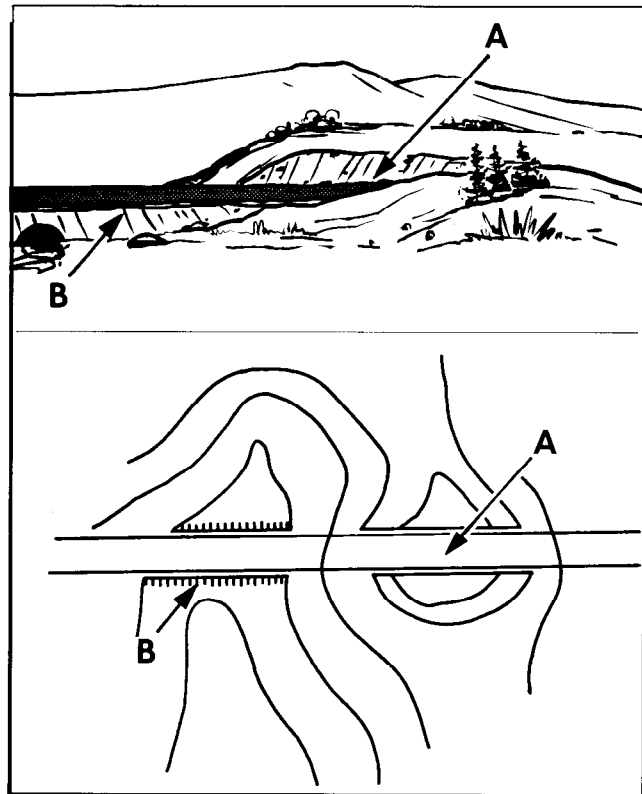

Figure 20-45. (A) Cut (B) Fill.

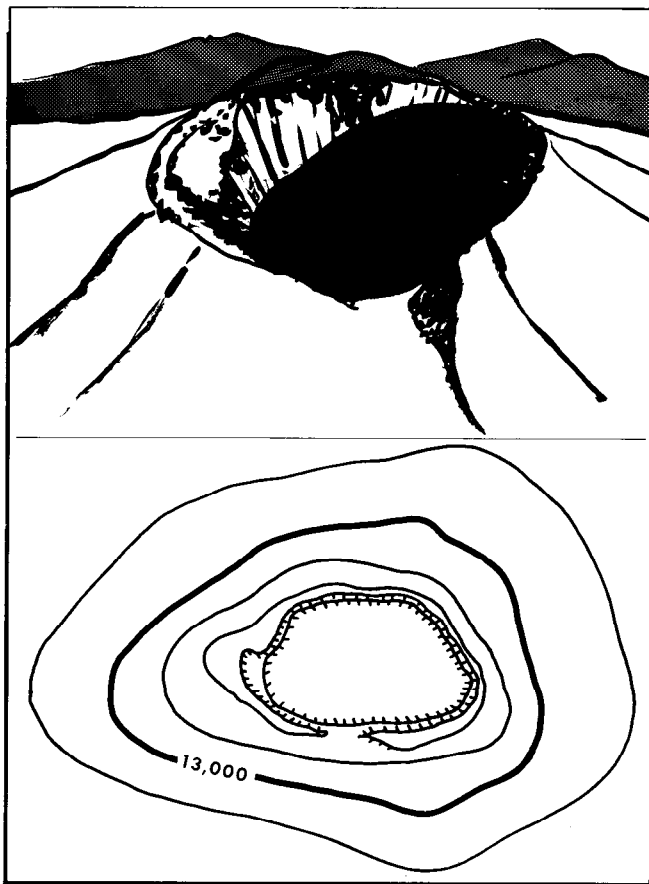

Figure 20-44. Depression.

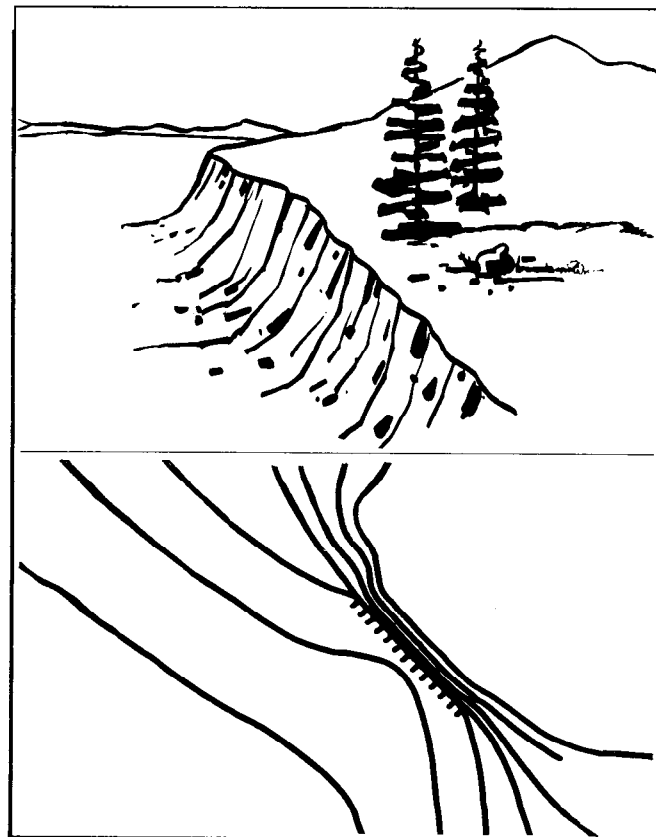

Figure 20-46. Cliff.

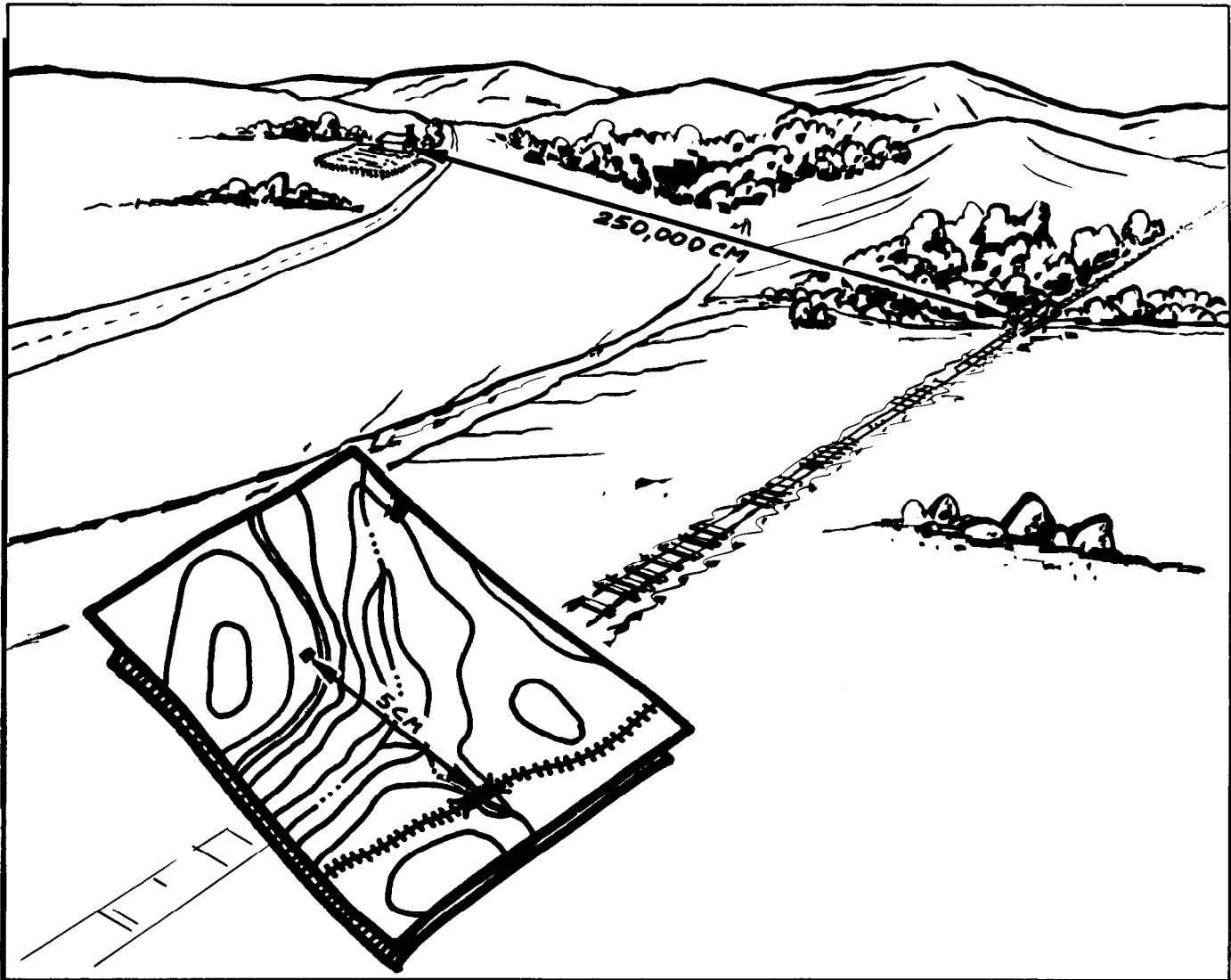

Figure 20-47. Ground Distance.

in any area of the world, and has a common unit of measure. Directions are expressed as units of angular measure. The most commonly used unit of angular measure is the degree with its subdivisions of minutes and seconds.

(1) Baselines. To measure anything, there must always be a starting point or zero measurement. To express a direction as a unit of angular measure, there must be a starting point or zero measure and a point of reference. These two points designate the base or refer-

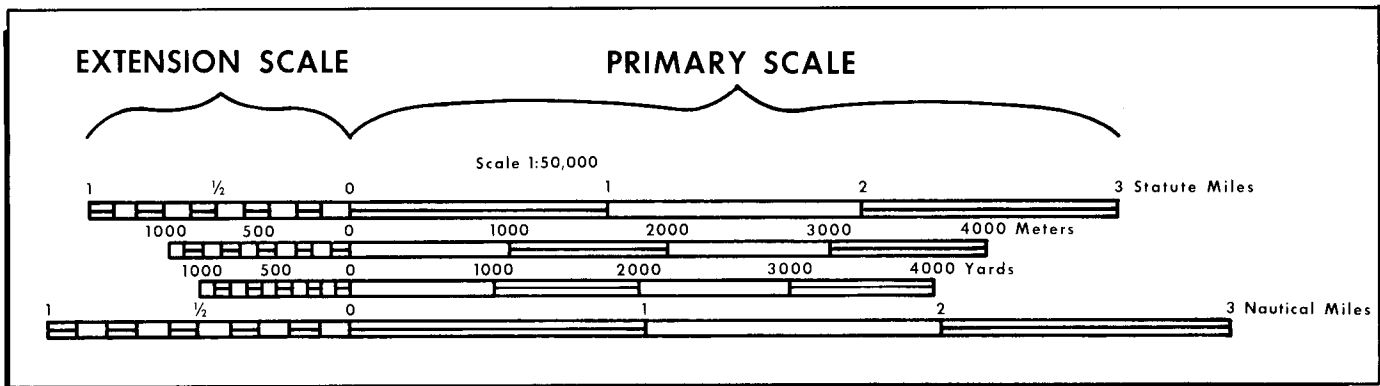

Figure 20-48. Graphic Bar Scale.

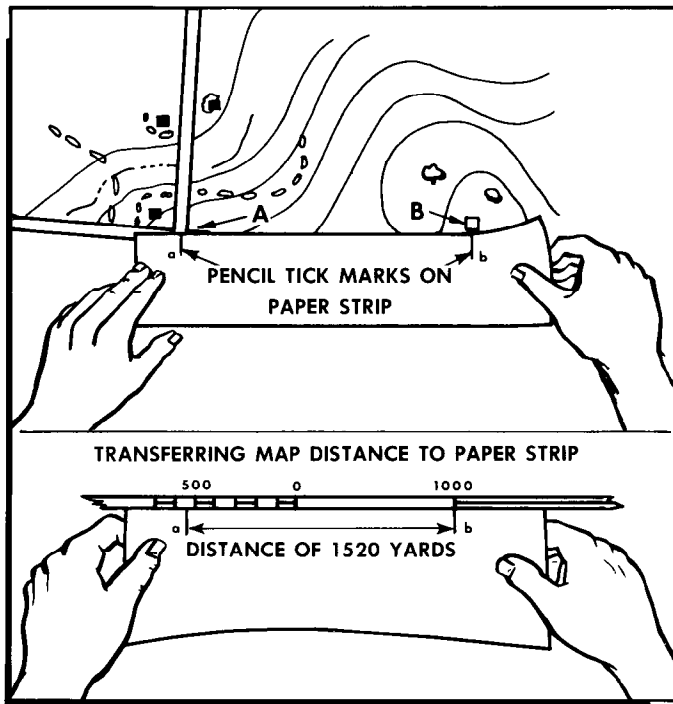

Figure 20-49. Measuring Straight Line Map Distances.

ence line. There are three baselines—true north, magnetic north, and grid north. Those most commonly used are magnetic and grid—the magnetic when working with a compass, and the grid when working with a military map.

(a) True north—a line from any position on the Earth's surface to the North Pole. All lines of longitude are true north lines. True north is usually symbolized by a star (figure 20-52).

(b) Magnetic north—the direction to the north magnetic pole, as indicated by the north-seeking needle of a magnetic instrument. Magnetic north is usually symbolized by a half arrowhead (figure 20-52).

(c) Grid north—the north established by the vertical grid lines on the map. Grid north may be symbolized by the letters GN or the letter Y.

(2) Azimuth and Back Azimuth:

(a) The most common method used by the military for expressing a direction is azimuths. An azimuth is defined as a horizontal angle, measured in a clockwise manner from a north baseline. When the azimuth between two points on a map is desired, the points are joined by a straight line and a protractor is used to measure the angle between north and the drawn line. This measured angle is the azimuth of the drawn line (figure 20-53). When using an azimuth, the point from which the azimuth originates is imagined to be the center of the azimuth circle (figure 20-54). Azimuths take their name from the baseline from which they are measured; true azimuths from true north, magnetic azimuths from magnetic north, and grid azimuths from

grid north (figure 20-52). Therefore, any given direction can be expressed in three different ways: a grid azimuth if measured on a military map, a magnetic azimuth if measured by a compass, or a true azimuth if measured from a meridian of longitude.

(b) A back azimuth is the reverse direction of an azimuth. It is comparable to doing an "about face." To obtain a back azimuth from an azimuth, add  $180^\circ$  if the azimuth is  $180^\circ$  or less, or subtract  $180^\circ$  if the azimuth is  $180^\circ$  or more (figure 20-55). The back azimuth of  $180^\circ$  may be stated as either  $000^\circ$  or  $360^\circ$ .

(3) Declination Diagram. A declination diagram is placed on most large-scale maps to enable the user to properly orient the map. The diagram shows the interrelationship of magnetic north, grid north, and true north (figure 20-56). On medium-scale maps, declination information is shown by a note in the map margin.

(a) Declination is the angular difference between true north and magnetic or grid north. There are two declinations, a magnetic declination (figure 20-57) and a grid declination.

(b) Grid-Magnetic (G-M) Angle is an arc indicated by a dashed line, which connects the grid north and the magnetic north prongs. The value of this arc (G-M ANGLE) states the size of the angle between grid north and magnetic north and the year it was prepared. This value is expressed to the nearest  $\frac{1}{2}^\circ$ , with mil equivalents shown to the nearest 10 mils.

(c) Grid Convergence is an arc, indicated by a dashed line, which connects the prongs for true north and grid north. The value of the angle for the center of the sheet is given to the nearest full minute with its equivalent to the nearest mil. These data are shown in the form of a grid convergence note.

(d) Conversion notes may also appear with the diagram explaining the use of the G-M angle. One note

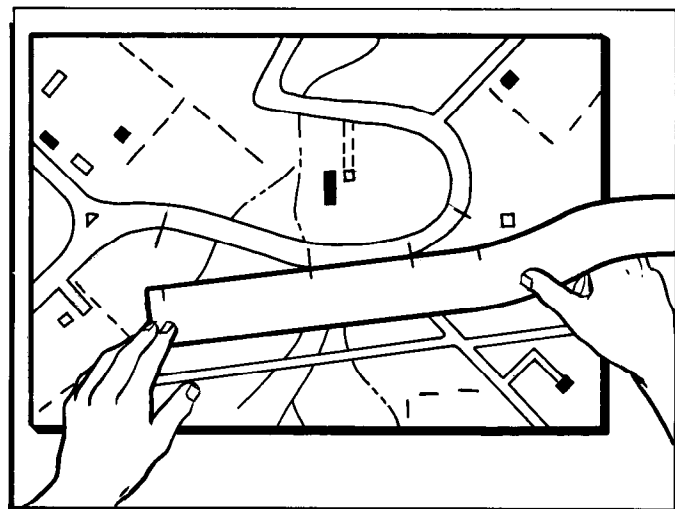

Figure 20-50. Measuring Curved Line Distances.

B-5. Conversion Factors							
One	Inches	Feet	Yards	Statute miles	Nautical miles	Millimeters	
Inch	1	0.0833	0.0277				25.40
Foot	12	1	0.333				304.8
Yard	36	3	1	0.00056			914.4
Statute Mile	63,360	5,280	1,760	1	0.8684		
Nautical Mile	72,963	6,080	2,026	1.1516	1		
Millimeter	0.0394	0.0033	0.0011				1
Centimeter	0.3937	0.0328	0.0109				10
Decimeter	3.937	0.328	0.1093				100
Meter	39.37	3.2808	1.0936	0.0006	0.0005		1,000
Decameter	393.7	32.81	10.94	0.0062	0.0054		10,000
Hectometer	3,937	328.1	109.4	0.0621	0.0539		100,000
Kilometer	39,370	3,281	1,094	0.6214	0.5396		1,000,000
Myriameter	393,700	32,808	10,936	6.2137	5.3959		10,000,000

One	cm	dm	m	dkm	hm	km	mym
Inch	2.540	0.2540	0.0254	0.0025	0.0003		
Foot	30.48	3.048	0.3048	0.0305	0.0030	0.0003	
Yard	91.44	9.144	0.9144	0.0914	0.0091	0.0009	
Statute Mile	160,930	16,093	1,609	160.9	16.09	1.6093	0.1609
Nautical Mile	185,325	18,532	1,853	185.3	18.53	1.8532	0.1853
Millimeter	0.1	0.01	0.001	0.0001			
Centimeter	1	0.1	0.01	0.001	0.0001		
Decimeter	10	1	0.1	0.01	0.001	0.0001	
Meter	100	10	1	0.1	0.01	0.001	0.0001
Decameter	1,000	100	10	1	0.1	0.01	0.001
Hectometer	10,000	1,000	100	10	1	0.1	0.01
Kilometer	100,000	10,000	1,000	100	10	1	0.1
Myriameter	1,000,000	100,000	10,000	1,000	100	10	1

<p><i>Example I</i>                  Problem: Reduce 76 centimeters to (?) inches  <math>76 \text{ cm} \times 0.3937 = 29 \text{ inches.}</math>                  Answer: There are 29 inches in 76 centimeters.</p>	<p><i>Example II</i>                  Problem: How many feet are there in 2.74 meters?  <math>\frac{2.74}{.3048} = 9 \text{ feet}</math>                  Answer: There are approximately 9 feet in 2.74 meters.</p>
--	--

Figure 20-51. Conversion Factors.

provides instructions for converting magnetic azimuth to grid azimuth; the other note provides for converting grid azimuth to magnetic azimuth. The conversion (add or subtract) is governed by the direction of the magnetic north prong relative to the grid north prong.

(e) The grid north prong is aligned with the easting grid lines on the map, and on most maps is formed by an extension of an easting grid line into the margin.

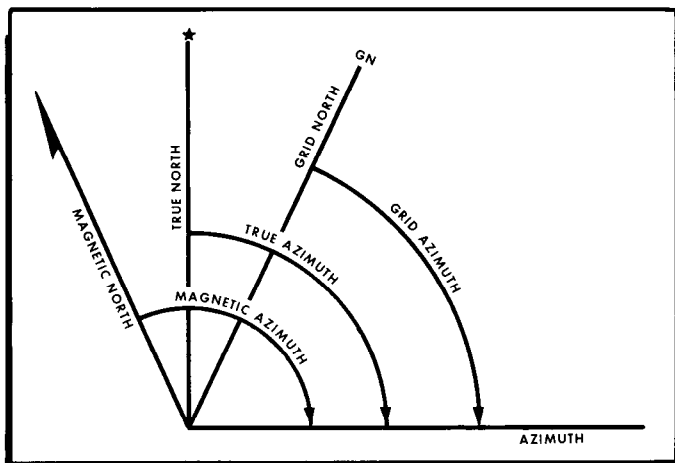

Figure 20-52. True, Grid and Magnetic Azimuths.

The angles between the prongs are seldom plotted exactly. The relative position of the directions is obtained from the diagram, but the numerical value should not be measured from it. For example, if the amount of declination from grid north to magnetic north is 1°, the arc shown in the diagram may be exaggerated if mea-

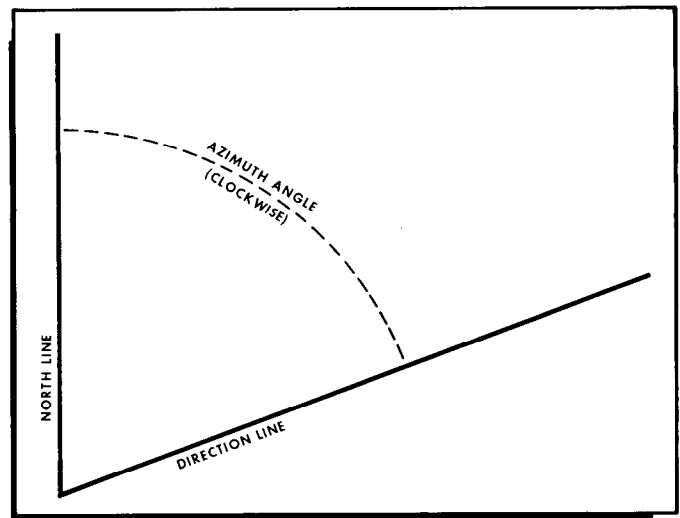

Figure 20-53. Azimuth Angle.

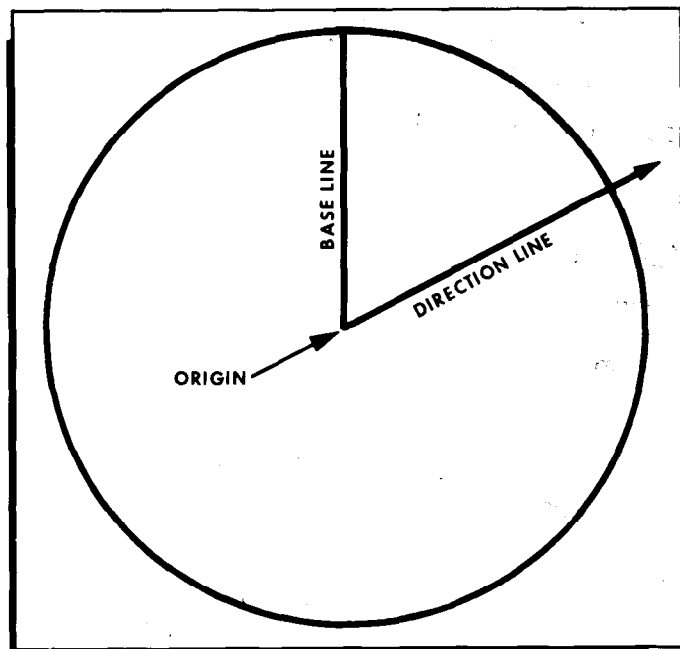

Figure 20-54. Origin of Azimuth Circle.

sured, having an actual value of  $5^\circ$ . The position of the three prongs in relation to each other varies according to the declination data for each map.

(f) Some older maps have a note under the declination diagram which gives the magnetic declination for a certain year and the amount of annual change. The annual change is so small when compared to the  $\frac{1}{2}^\circ$  value of the G-M angle that it is no longer shown on standard large scale maps.

(4) Protractors. Protractors come in several forms—full circle, half circle, square, and rectangular (figure 20-58). All of them divide a circle into units of angular measure, and regardless of their shape, consist of a scale around the outer edge and an index mark. The index mark is the center of the protractor circle from which all the direction lines radiate.

(a) To determine the grid azimuth of a line from one point to another on the map from (A to B or C to D) (figure 20-59), draw a line connecting the two points.

-1. Place the index of the protractor at that point where the line crosses a vertical (north-south) grid line.

-2. Keeping the index at this point, align the  $0^\circ$  -  $180^\circ$  line of the protractor on the vertical grid line.

-3. Read the value of the angle from the scale; this is the grid azimuth to the point.

(b) To plot a direction line from a known point on a map (figure 20-60):

-1. Construct a north-south grid line through the known point:

-a. Generally, align the  $0^\circ$  -  $180^\circ$  line of the protractor in a north-south direction through the known point.

-b. Holding the  $0^\circ$  -  $180^\circ$  line of the protractor on the known point, slide the protractor in the north-south direction until the horizontal line of the protractor (connecting the protractor index and the  $90^\circ$  tick mark) is aligned on an east-west grid line.

-c. Then draw a line connecting  $0^\circ$ , the known point, and  $180^\circ$ .

-2. Holding the  $0^\circ$  -  $180^\circ$  line on the north-south line, slide the protractor index to the known point.

-3. Make a mark on the map at the required angle. (In an evasion situation, do not mark on the map.)

-4. Draw a line from the known point through the mark made on the map. This is the grid direction line.

#### (5) The Compass and Its Uses:

(a) The magnetic compass is the most commonly used and simplest instrument for measuring directions and angles in the field. The lensatic compass (figure 20-61) is the standard magnetic compass for military use today.

(b) The lensatic compass must always be held level and firm when sighting on an object and reading an azimuth (figure 20-62). There are several techniques for holding the compass and sighting. One way is to align the sighting slot with the hairline on the front sight

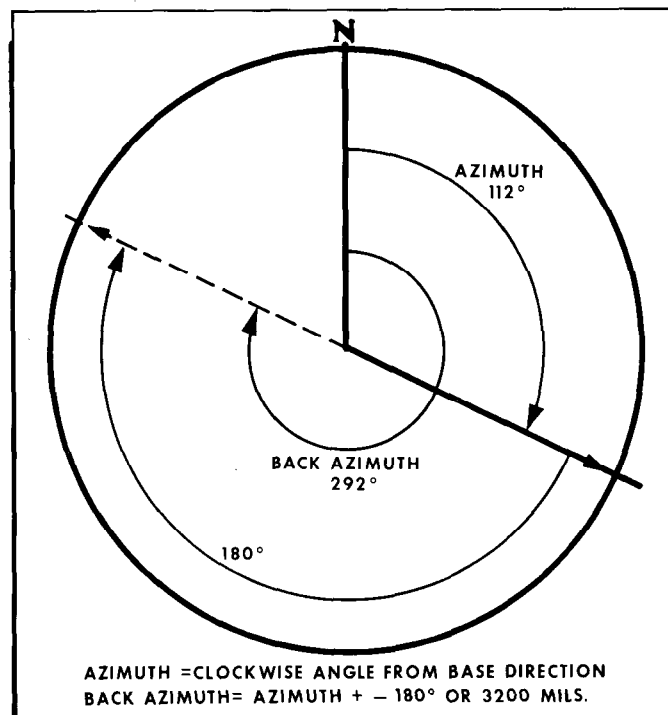

Figure 20-55. Azimuth and Back Azimuth.

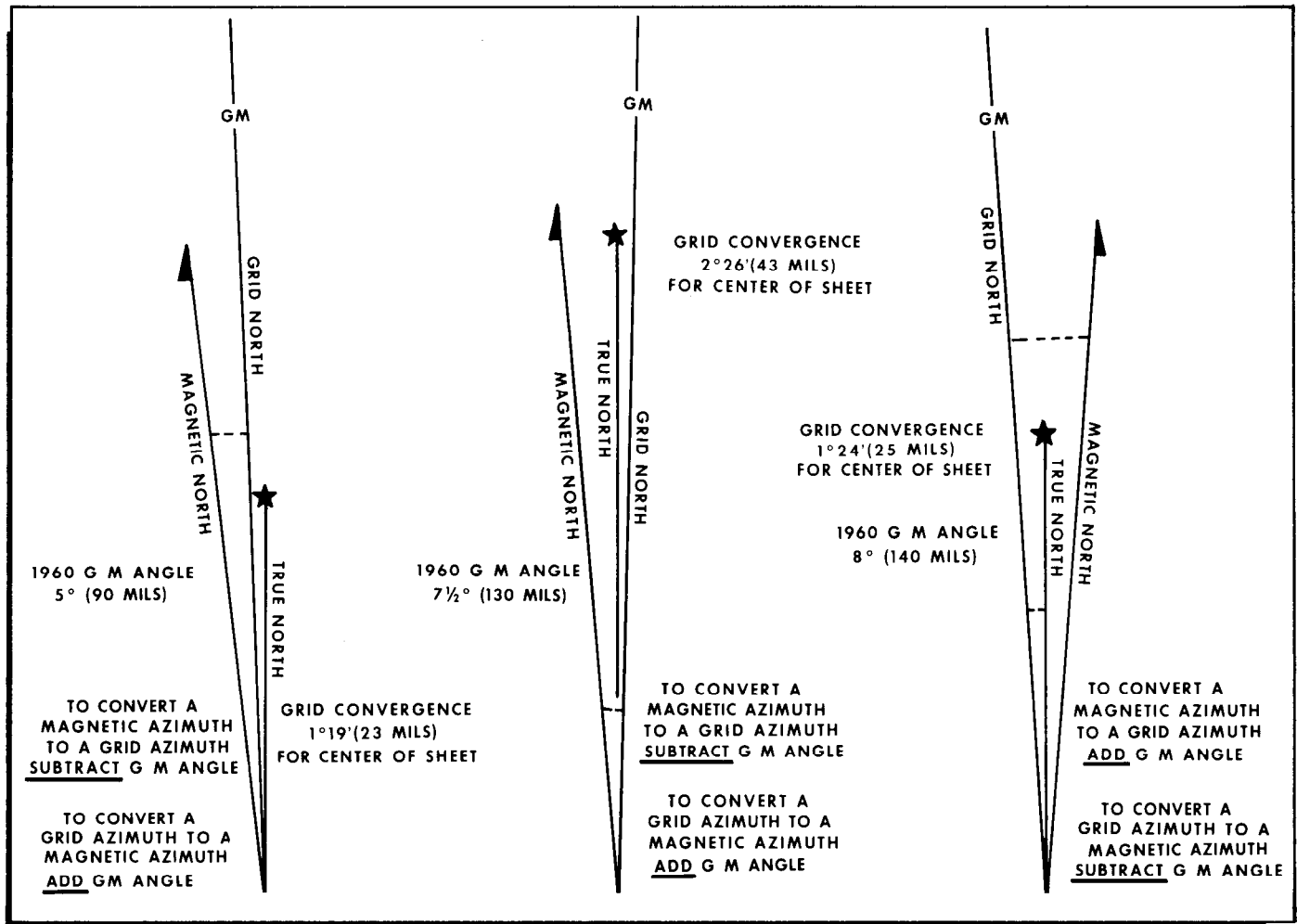

Figure 20-56. Declination Diagram (East and West).

in the cover and the target. The azimuth can then be read by glancing down at the dial through the lens. This technique provides a reading precise enough to use.

(6) Night Use of the Compass. For night use, special features of the compass include the luminous markings, the bezel ring, and two luminous sighting dots. Turning the bezel ring counterclockwise causes an increase in azimuth, while turning it clockwise causes a decrease. The bezel ring has a stop and spring which allows turns at  $3^\circ$  intervals per click and holds it at any desired position. One accepted method for determining compass directions at night is:

(a) Rotate the bezel ring until the luminous line is over the black index line.

(b) Hold the compass with one hand and rotate the bezel ring in a counterclockwise direction with the other hand to the number of clicks required. The number of clicks is determined by dividing the value of the required azimuth by 3. For example, for an azimuth of  $51^\circ$ , the bezel ring would be rotated 17 clicks counterclockwise (figure 20-63).

(c) Turn the compass until the north arrow is directly under the luminous line on the bezel.

(d) Hold the compass open and level in the palm of the left hand with the thumb along the side of the compass. In this manner, the compass can be held consistently in the same position. Position the compass approximately halfway between the chin and the belt, pointing to the direct front. (Practice in daylight will make a person proficient in pointing the compass the same way every time.) Looking directly down into the compass, turn the body until the north arrow is under the luminous line. Then proceed forward in the direction of the luminous sighting dots (figure 20-61). When the compass is to be used in darkness, an initial azimuth should be set while light is still available. With this initial azimuth as a base, any other azimuth which is a multiple of  $3^\circ$  can be established through use of the clicking feature of the bezel ring. The magnetic compass is a delicate instrument, especially the dial balance. The survivor should take care in its use. Compass readings should never be taken near visible masses of iron or electrical circuits.



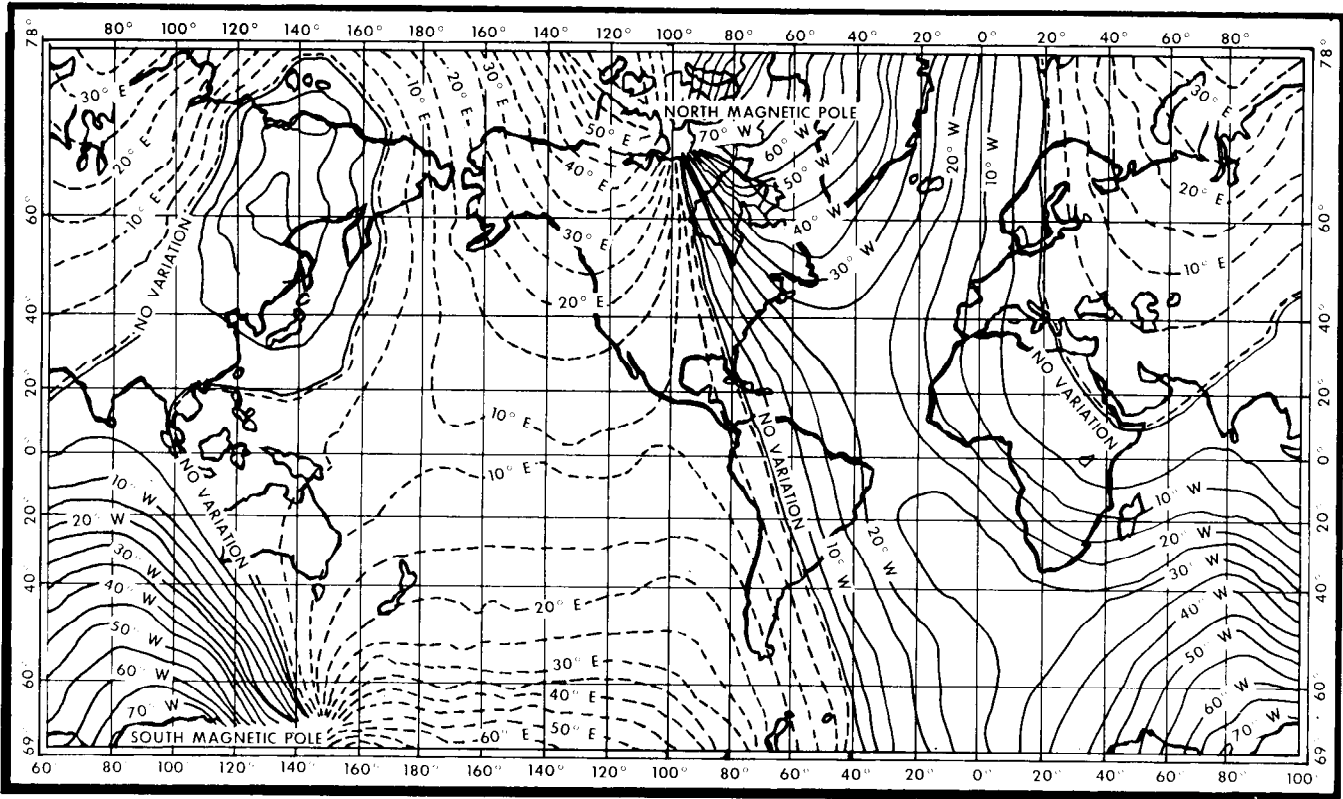

Figure 20-57. Lines of Magnetic Variation.

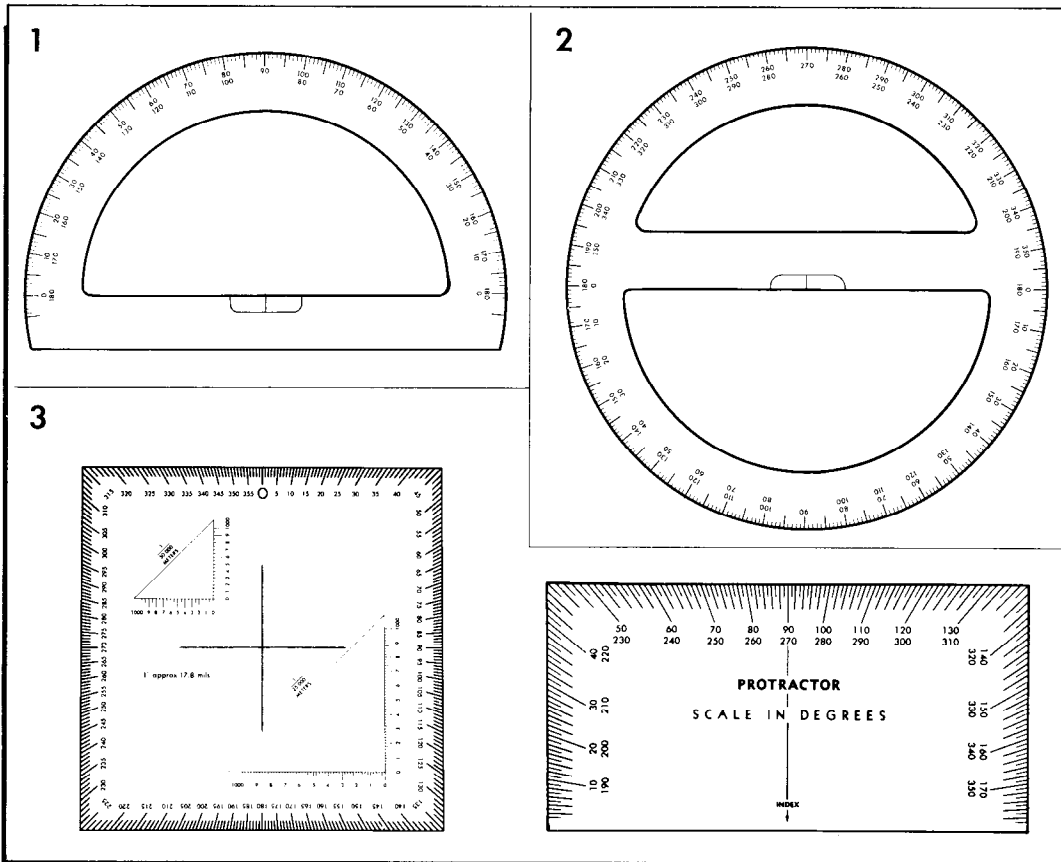

Figure 20-58. Types of Protractors.

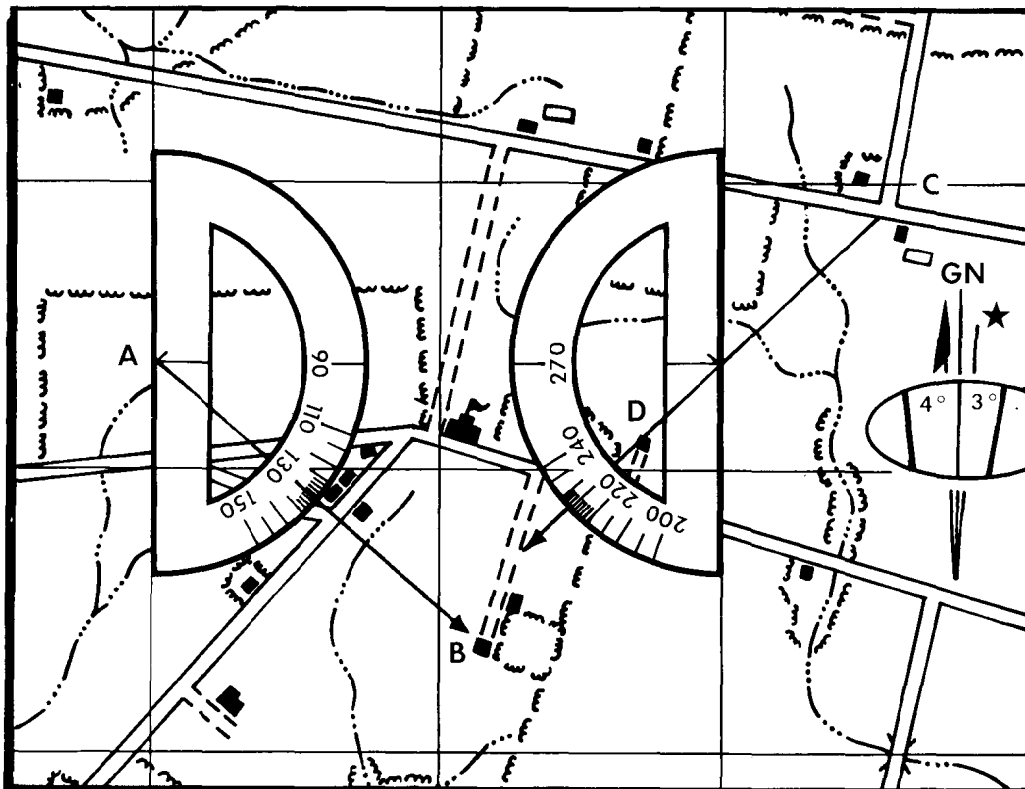

Figure 20-59. Measuring an Azimuth on a Map.

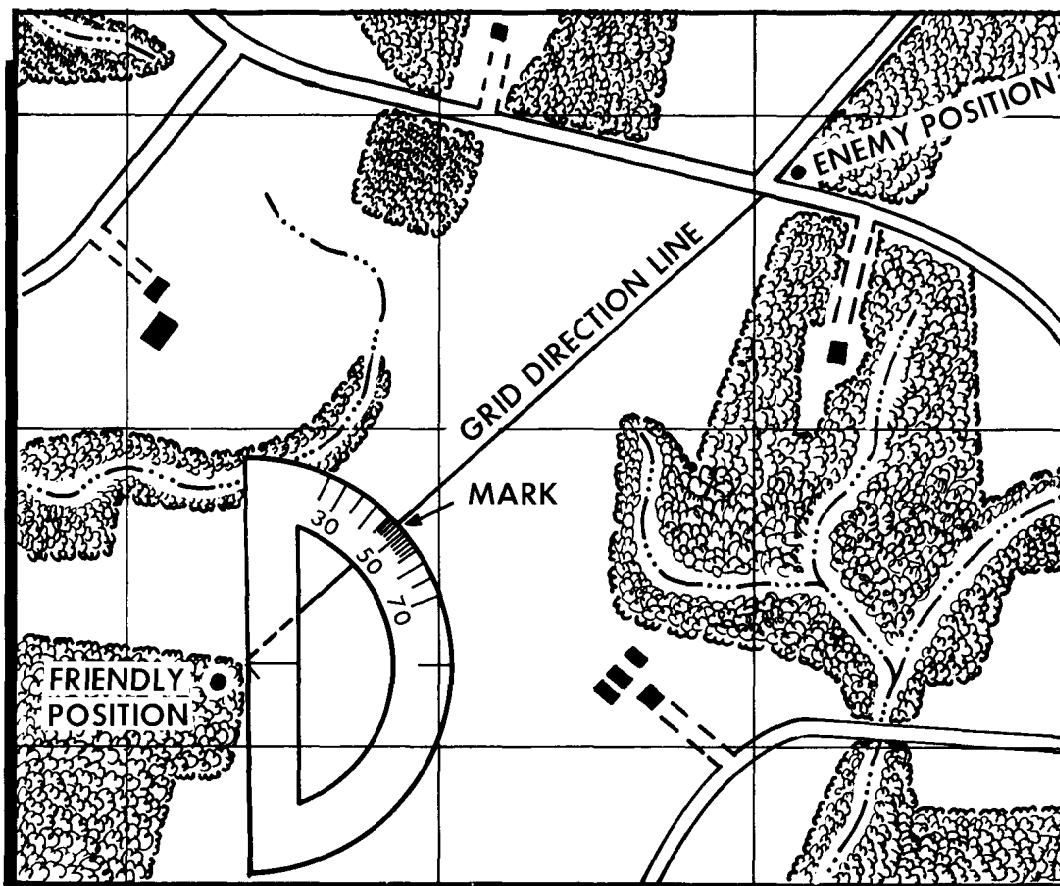

Figure 20-60. Plotting an Azimuth on a Map.

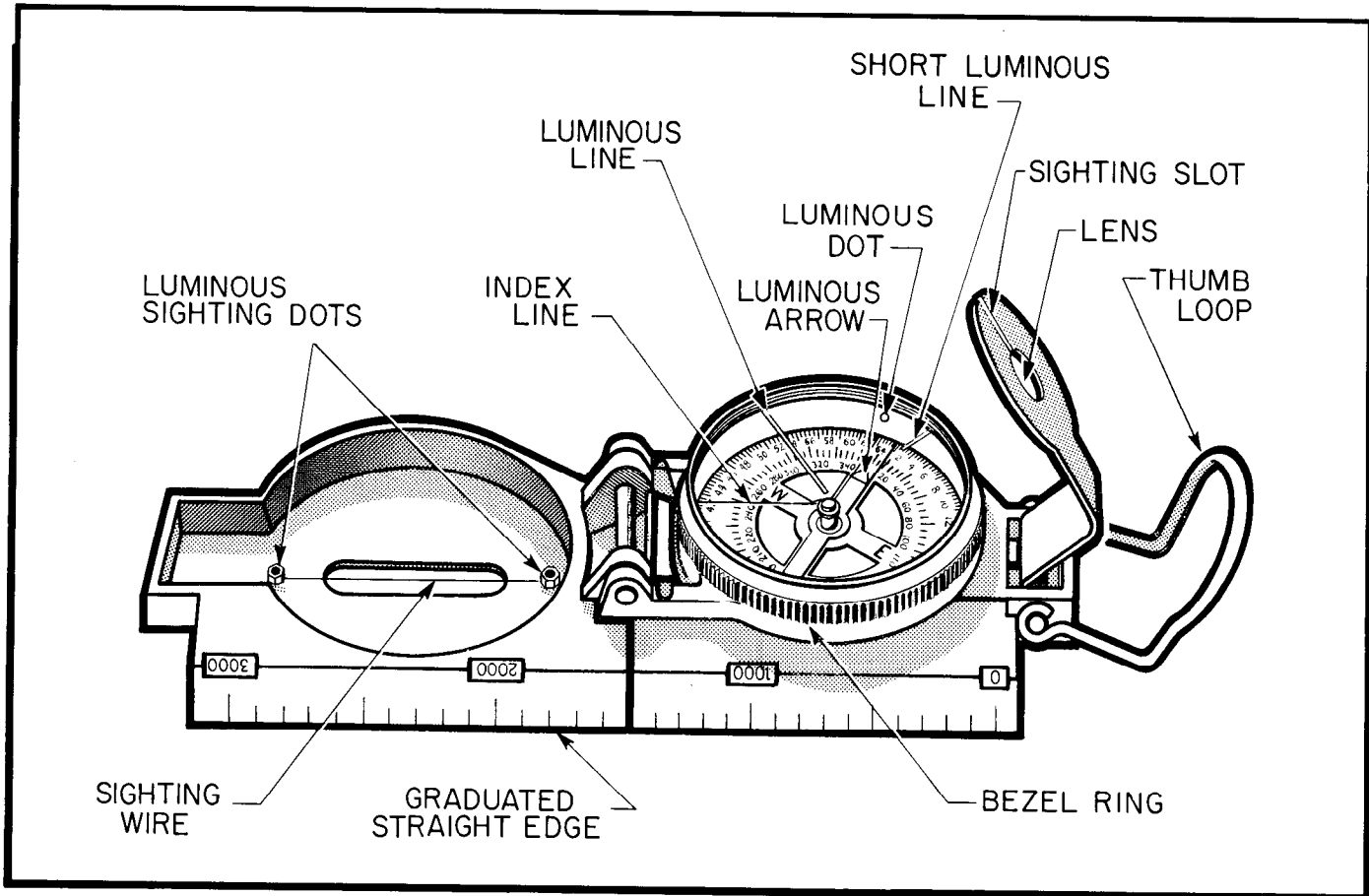

Figure 20-61. Lensatic Compass.



Figure 20-62. Holding the Compass.

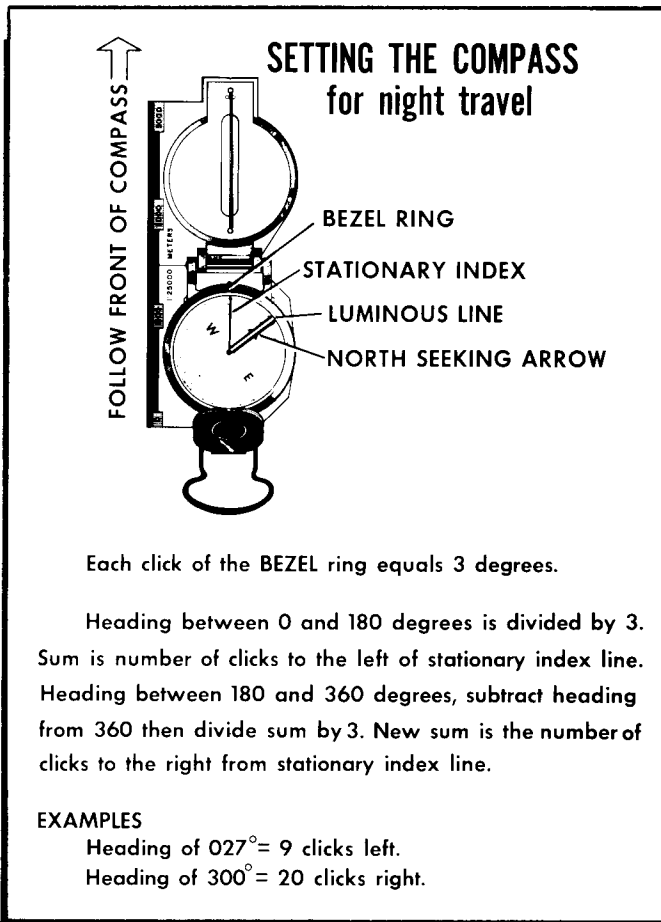

Figure 20-63. Night Travel.

(7) Map Orientation:

(a) A map is oriented when it is in a horizontal position with its north and south corresponding to north and south on the ground. The best way to orient a map is with a compass. (NOTE: Caution should be used to ensure nothing (metal, mine ore, etc.) in the area will alter the compass reading.)

(b) With the map in a horizontal position, the lensatic compass is placed parallel to a north-south grid line with the cover side of the compass pointing toward the top of the map. This will place the black index line on the dial of the compass parallel to grid north. Since the needle on the compass points to magnetic north, a declination diagram is (on the face of the compass) formed by the index line and the compass needle.

(c) Rotate the map and compass until the directions of the declination diagram formed by the black index line and compass needle match the directions shown on the declination diagram printed in the margin of the map. The map is then oriented (grid north).

(d) If the magnetic north arrow on the map is to the left of grid north, the compass reading will equal the G-M angle (given in the declination diagram). If the

magnetic north is to the right of grid north, the compass reading will equal  $360^\circ$  minus the G-M angle. In figure 20-64, the declination diagram illustrates a magnetic north to the right of grid north and the compass reading will be  $360^\circ$  minus  $21\frac{1}{2}^\circ$  or  $338\frac{1}{2}^\circ$ .

(e) Remember to point the compass north arrow in the same direction as the magnetic north arrow, and the compass reading (equal to the G-M angle or the  $360^\circ$  minus G-M angle) will be quite apparent.

(f) In summary, if the variation is to the east of true north or the magnetic north arrow of the declination diagram is to the east (right) of the grid north line, subtract the degrees of variation from  $360^\circ$ . If it is to the left (west), add to  $000^\circ$ . East is least and west is best.

(g) If a grid line is not used, a true north-south line can be used. True north-south lines are longitudinal lines or lines formed by the vertical lines on a tick map (assuming the top of the map is north). The same procedure is used if magnetic variation is figured from true north—not grid north.

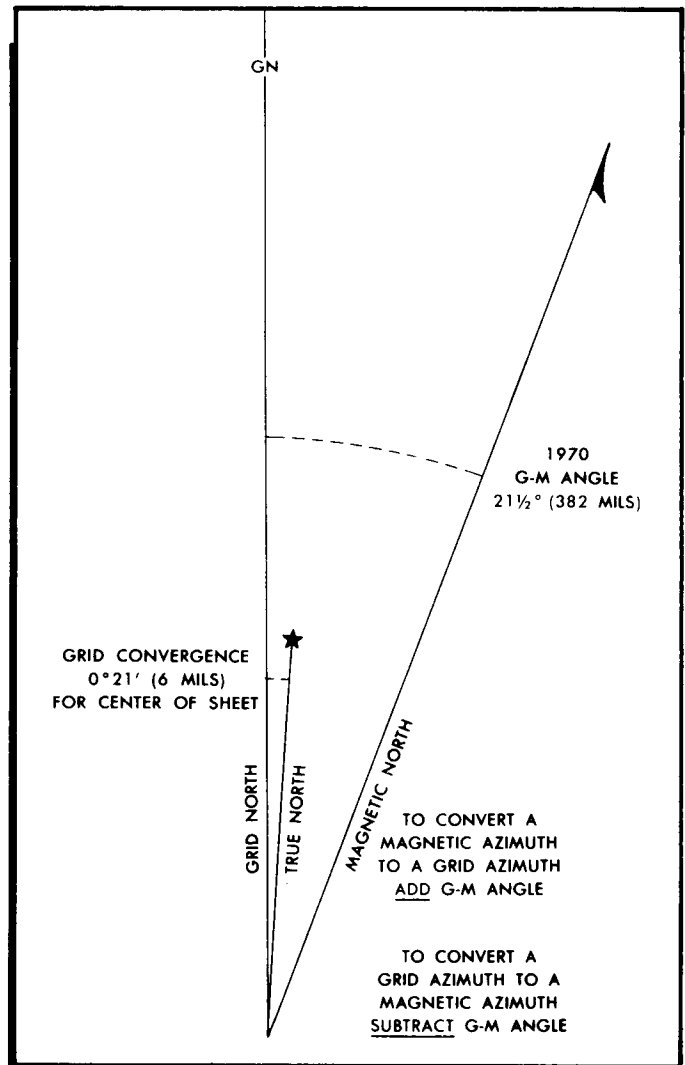

Figure 20-64. Declination Diagram.

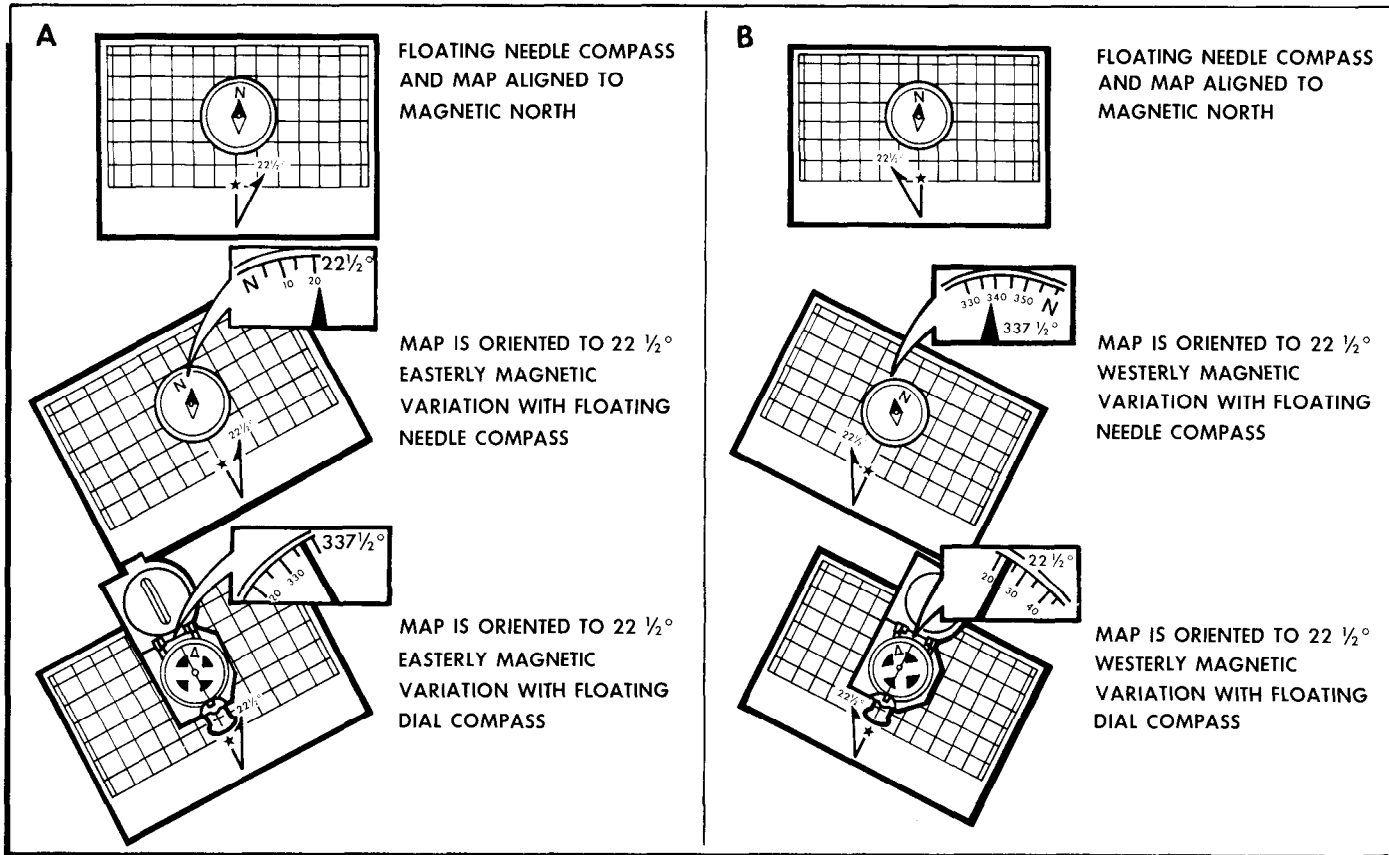

Figure 20-65. Floating Needle Compass.

(h) A floating needle compass (figures 20-65a and 20-65b) has a needle with a north direction marked on it. The degree and direction marks are stationary on the bottom inside of the compass. The button and wrist compasses may be floating dial or floating needle. To determine the heading, line up the north-seeking arrow over  $360^\circ$  by rotating the compass. Then read the desired heading. Orienting a map with a floating needle compass is similar to the method used with the floating dial. The only exception is with the adjustment for magnetic variation. If magnetic variation is to the east, turn the map and the compass to the left (the north axis of the compass should be aligned with the map north) so that the magnetic north-seeking arrow is pointing at the number of degrees on the compass which corresponds with the angle of declination.

(i) When a compass is not available, map orientation requires a careful examination of the map and the ground to find linear features common to both, such as roads, railroads, fence lines, power lines, etc. By aligning the feature on the map with the same feature on the ground (figure 20-66), the map is oriented. Orientation by this method must be checked to prevent the reversal of directions which may occur if only one linear feature is used. This reversal may be prevented by aligning two or more map features (terrain or manmade). If no sec-

ond linear feature is visible but the map user's position is known, a prominent object may be used. With the

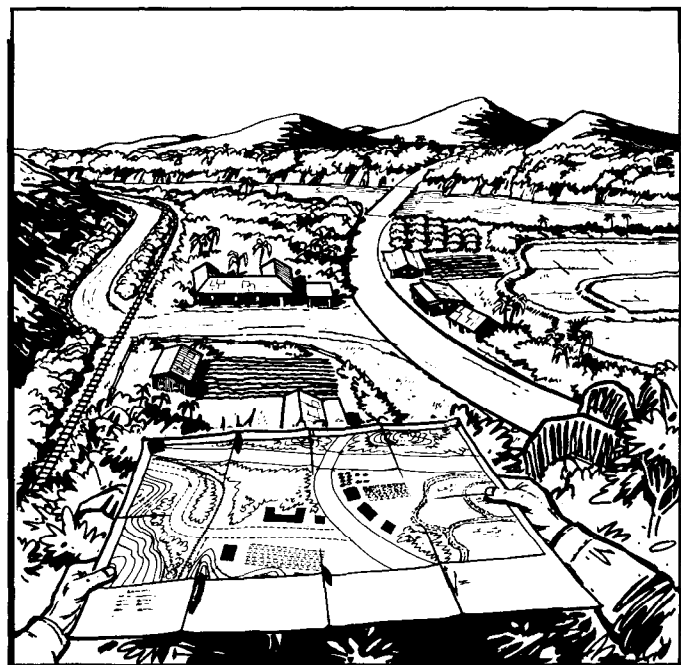

Figure 20-66. Map Orientation by Inspection.

prominent object and the user's position connected with a straight line on the map, the map is rotated until the line points toward the feature.

(j) If two prominent objects are visible and plotted on the map and the position is not known, move to one of the plotted and known positions, place the straightedge or protractor on the line between the plotted positions, turn the protractor and the map until the other plotted and visible point is seen along the edge. The map is then oriented.

(k) When a compass is not available and there are no recognizable prominent landforms or other features, a map may be oriented by any of the field expedient methods we will now discuss.

(8) Determining Cardinal Directions Using Field Expedients:

\*(a) Shadow tip method of determining direction and time. This simple method of finding direction by the Sun consists of only three basic steps (figure 20-67).

-1. Step 1. Place a stick or branch into the ground at a fairly level spot where a distinct shadow will be cast. Mark the shadow tip with a stone, twig, or other means.

-2. Step 2. Wait until the shadow tip moves a few inches. If a 4-foot stick is being used, about 10 minutes should be sufficient. Mark the new position of the shadow tip in the same way as the first.

-3. Step 3. Draw a straight line through the two marks to obtain an approximate east-west line. If uncertain which direction is east and which is west, observe this simple rule: The Sun "rises in the east and sets in the west" (but rarely DUE east and DUE west). The shadow tip moves in just the opposite direction. Therefore, the first shadow-tip mark is always in the west direction, and the second mark in the east direction, anywhere on Earth.

(b) A line drawn at right angles to the east-west line at any point is the approximate north-south line, which will help orient a person to any desired direction of travel.

(c) Inclining the stick to obtain a more convenient shadow does not impair the accuracy of the shadow-tip method. Therefore, a traveler on sloping ground or in highly vegetated terrain need not waste valuable time looking for a large level area. A flat spot, the size of the hand, is all that is necessary for shadow-tip markings and the base of the stick can be either above, below, or to one side of it. Also, any stationary object (the end of a tree limb or the notch where branches are jointed) serves just as well as an implanted stick because only

\*From *Better Ways of Pathfinding*, by Robert S. Owendoff, 153 Cundry Drive, Falls Church VA 22046. 1964§ by Stackpole Company, Harrisburg PA. All rights reserved by copyright owner (author).

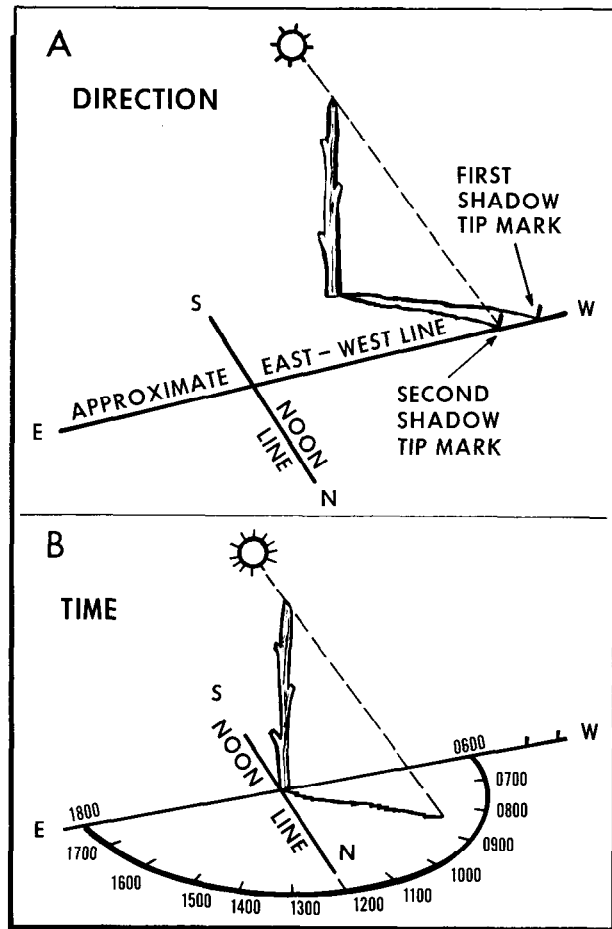

Figure 20-67. Determining Time and Direction by Shadow.

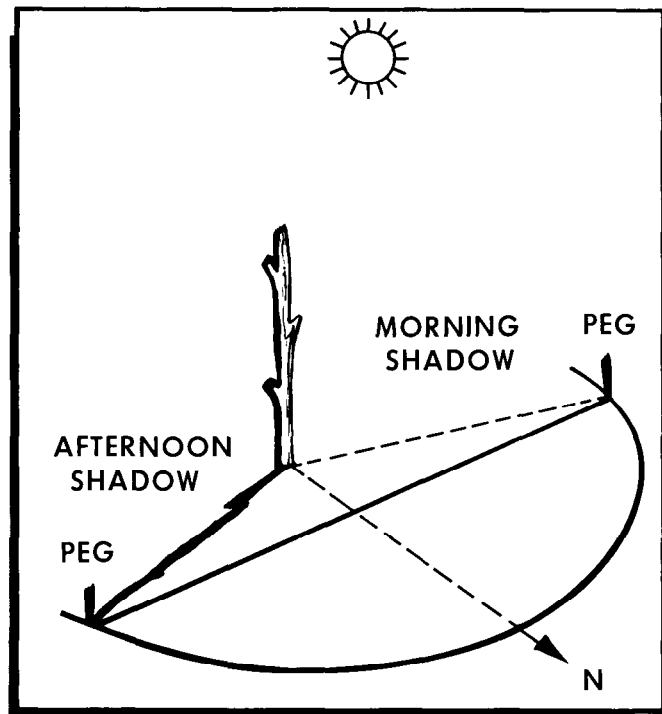

Figure 20-68. Equal Shadow Method of Determining Direction.

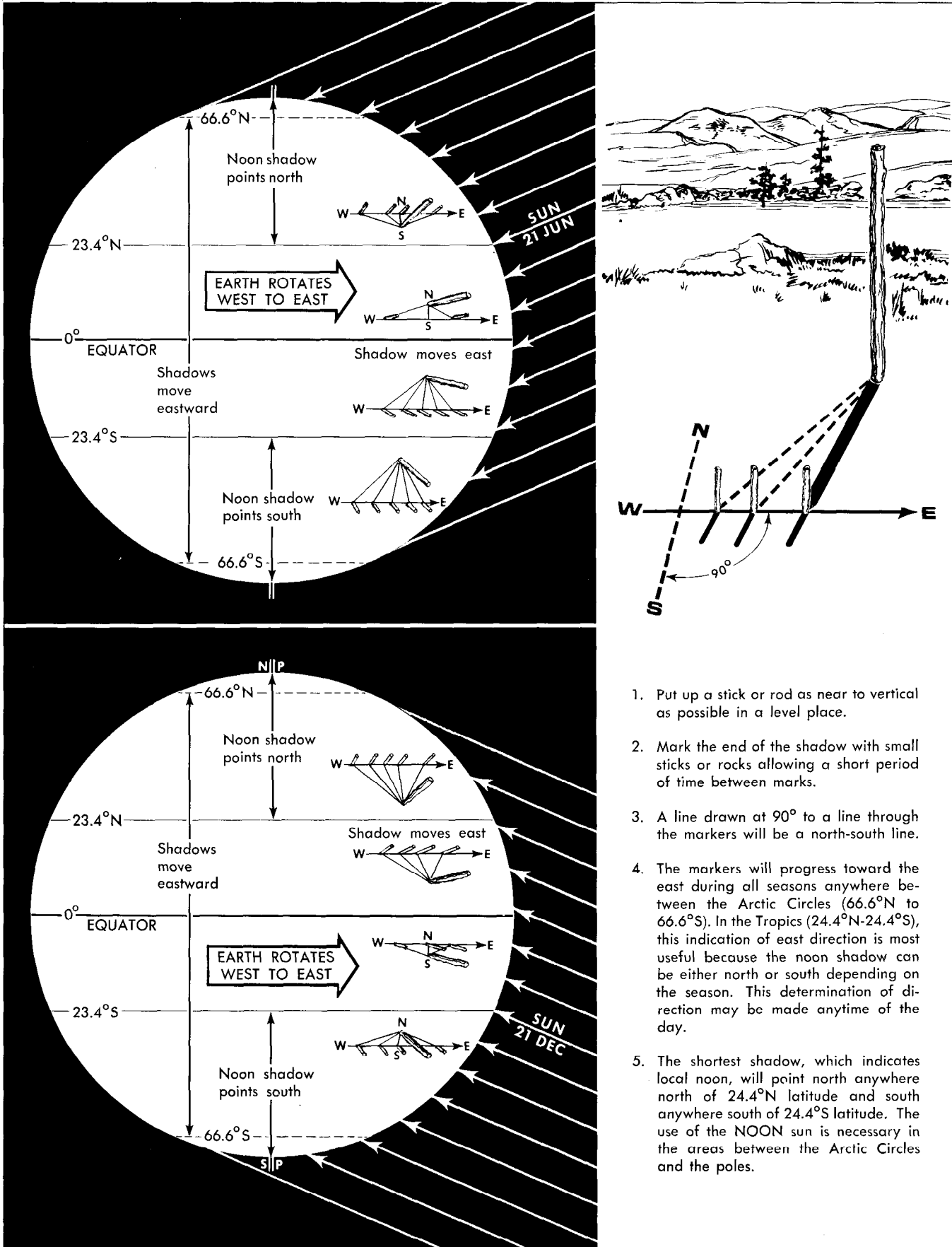

Figure 20-69. Stick and Shadow Method of Determining Direction.

the shadow tip is marked.

(d) The shadow-tip method can also be used to find the approximate time of day (figure 20-67B).

-1. To find the time of day, move the stick to the intersection of the east-west line and the north-south line, and set it vertically in the ground. The west part of the east-west line indicates the time is 0600 and the east part is 1800, ANYWHERE on Earth, because the basic rule always applies.

-2. The north-south line now becomes the noon line. The shadow of the stick is an hour hand in the shadow clock and with it the time can be estimated using the noon line and 6 o'clock line as the guides. Depending on the location and the season, the shadow may move either clockwise or counterclockwise, but this does not alter the manner of reading the shadow clock.

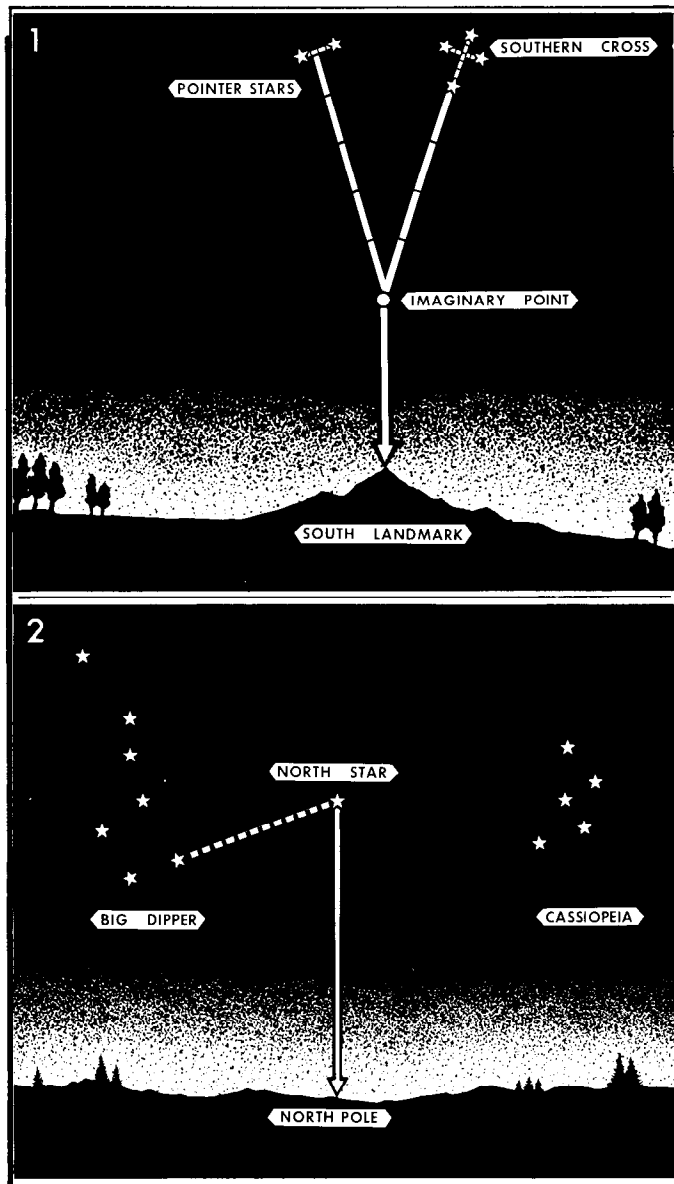

Figure 20-70. Determination of Direction by Using the Stars.

-3. The shadow clock is not a timepiece in the ordinary sense. It always reads 0600 at sunrise and 1800 at sunset. However, it does provide a satisfactory means of telling time in the absence of properly set watches. Being able to establish the time of day is important for such purposes as keeping a rendezvous, prearranged concerted action by separated persons or groups, and estimating the remaining duration of daylight. Shadow-clock time is closest to conventional clock time at mid-day, but the spacing of the other hours, compared to conventional time, varies somewhat with the locality and date.

(e) The shadow-tip system is ineffective for use beyond  $66\frac{1}{2}^\circ$  latitude in either hemisphere due to the position of the Sun above the horizon. Whether the Sun is north or south of a survivor at mid-day depends on the latitude. North of  $23.4^\circ\text{N}$ , the Sun is always due south at local noon and the shadow points north. South of  $23.4^\circ\text{S}$ , the Sun is always due north at local noon and the shadow points south. In the tropics, the Sun can be either north or south at noon, depending on the date and location but the shadow progresses to the east regardless of the date.

(f) Equal-shadow method of determining direction (Figures 20-68 and 20-69). This variation of the shadow-tip method is more accurate and may be used at all latitudes less than  $66^\circ$  at all times of the year.

-1. Step 1. Place a stick or branch into the ground vertically at a level spot where a shadow at least 12 inches long will be cast. Mark the shadow tip with a stone, twig, or other means. This must be done 5 to 10 minutes before noon (when the Sun is at its highest point (zenith)).

-2. Step 2. Trace an arc using the shadow as the radius and the base of the stick as the center. A piece of string, shoelace, or a second stick may be used to do this.

-3. Step 3. As noon is approached, the shadow becomes shorter. After noon, the shadow lengthens until it crosses the arc. Mark the spot as soon as the shadow tip touches the arc a second time.

-4. Step 4. Draw a straight line through the two marks to obtain an east-west line.

(g) Although this is the most accurate version of the shadow-tip method, it must be performed around noon. It requires the observer to watch the shadow and complete step 3 at the exact time the shadow tip touches the arc.

(h) At night, the stars may be used to determine the north line in the northern hemisphere or the south line in the southern hemisphere. Figure 20-70 shows how this is done.

(i) A watch can be used to determine the approximate true north or south (figure 20-71). In the northern hemisphere, the hour hand is pointed toward the Sun. A south line can be found midway between the hour hand



and 1200 standard time. During daylight savings time, the north-south line is midway between the hour hand and 1300. If there is any doubt as to which end of the line is north, remember that the Sun is in the east before noon and in the west in the afternoon.

(j) The watch may also be used to determine direction in the Southern Hemisphere; however, the method is different. The 1200-hour dial is pointed toward the Sun, and halfway between 1200 and the hour hand will be a north line. During daylight savings time, the north line lies midway between the hour hand and 1300.

(k) The watch method can be in error, especially in the extreme latitudes, and may cause "circling." To avoid this, make a shadow clock and set the watch to the time indicated. After traveling for an hour, take another shadow-clock reading.

(9) Determining Specific Position. When using a map and compass, the map must be oriented using the method described earlier in this chapter. Next, locate two or three known positions on the ground and the map. Using the compass, shoot an azimuth to one of the known positions (figure 20-72). Once the azimuth is

determined, recheck the orientation of the map and plot the azimuth on the map. To plot the azimuth, place the front corner of the straightedge of the compass on the corresponding point on the map. Rotate the compass until the determined azimuth is directly beneath the stationary index line. Then draw a line along the straightedge of the compass and extend the line past the estimated position on the map. Repeat this procedure for the second point (figure 20-72). If only two azimuths are used, the technique is referred to as biangulation (figure 20-72). If a third azimuth is plotted to check the accuracy of the first two, the technique is called triangulation (figure 20-72). When using three lines, a triangle of error may be formed. If the triangle is large, the work should be checked. However, if a small triangle is formed, the user should evaluate the terrain to determine the actual position. One azimuth may be used with a linear land feature such as a river, road, railroad, etc., to determine specific position (figure 20-72).

(10) Determining Specific Location Without a Compass. A true north-south line determined by the stick and shadow, Sun and watch, or celestial constella-

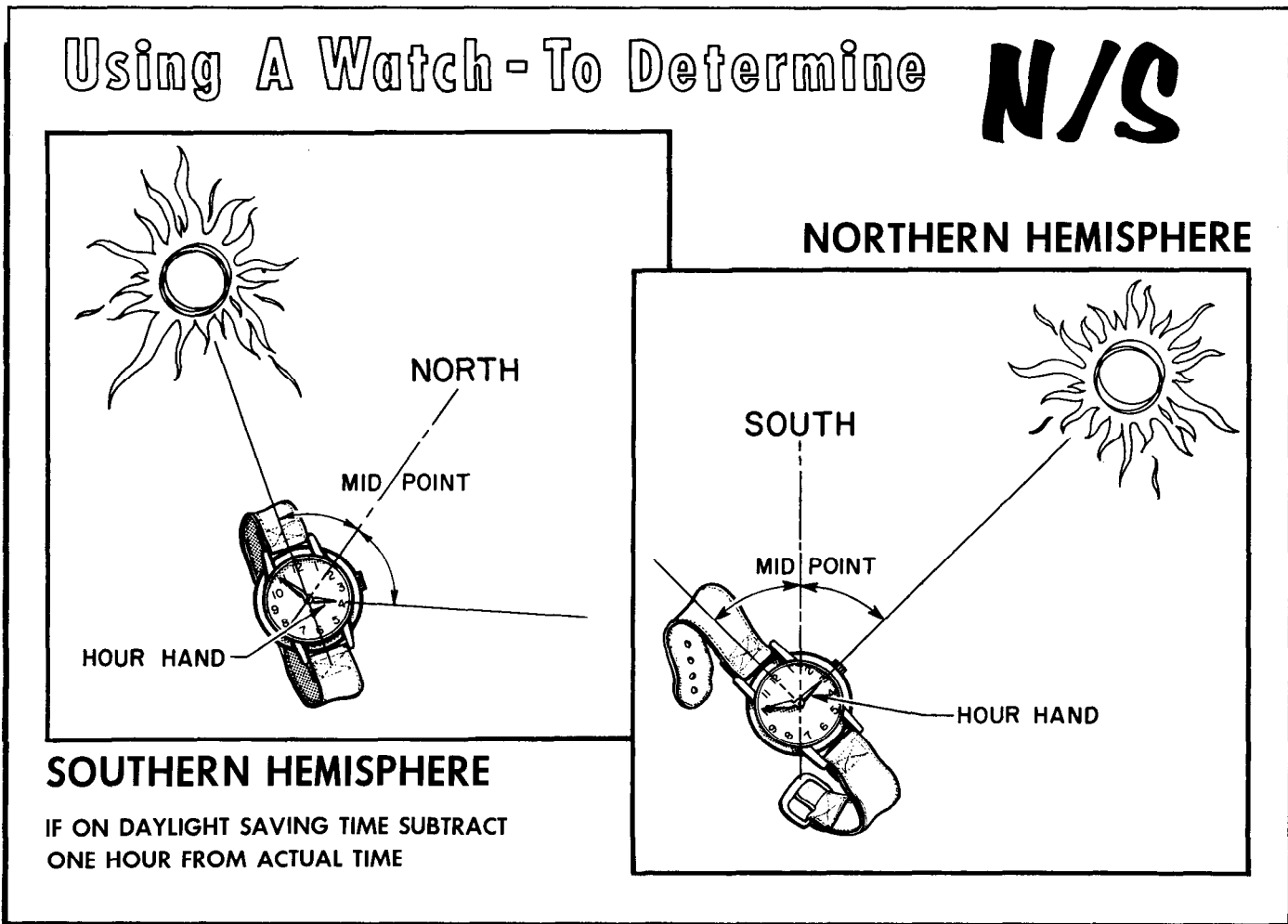

Figure 20-71. Directions Using a Watch.

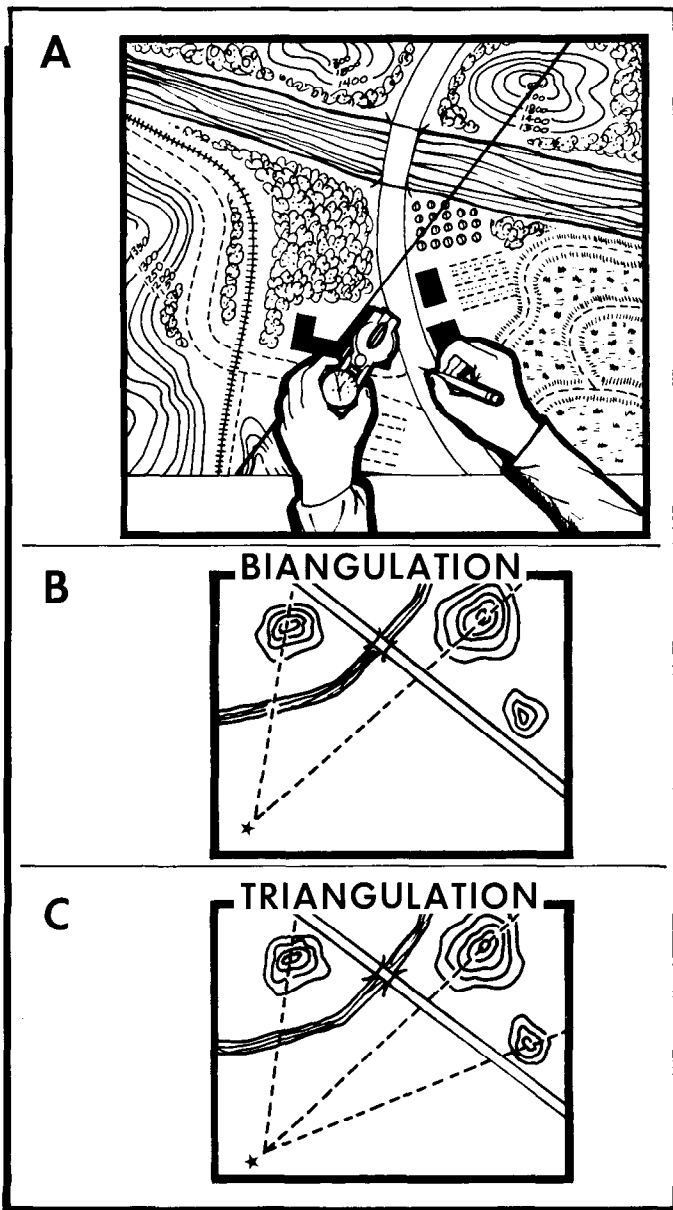

Figure 20-72. Azimuth, Biangulation, and Triangulation.

tion method may be used to orient the map without a compass. However, visible major land features can be used to orient the map to the lay of the land. Once the map is oriented, identify two or three landmarks and mark them on the map. Lay a straightedge on the map with the center of the straightedge at a known position as a pivot point and rotate the straightedge until the known position of the map is aligned with present position, and draw a line. Repeat this for the second and third position. Each time a line of position is plotted, the map must still be aligned with true north and south. If three lines of position are plotted and form a small triangle, use terrain evaluation to determine present position. If they form a large triangle, recheck calculations for errors.

(11) Dead Reckoning:

(a) Dead reckoning is the process of locating one's position by plotting the course and distance from the last known location. In areas where maps exist, even poor ones, travel is guided by them. It is a matter of knowing one's position at all times by associating the map features with the ground features. A great portion of the globe is unmapped or only small scale maps are available. The survivor may be required to travel in these areas without a usable map. Although these areas could be anywhere, they are more likely to be found in frozen wastelands and deserts.

(b) For many centuries, mariners used dead reckoning to navigate their ships when they were out of sight of land or during bad weather, and it is just as applicable to navigation on land. Movement on land must be carefully planned. In military movement, the starting location and destination are known, and if a map is available, they are carefully plotted along with any known intermediate features along the route. These intermediate features, if clearly recognizable on the ground, serve as checkpoints. If a map is not available, the plotting is done on a blank sheet of paper. A scale is selected so the entire route will fit on one sheet. A north direction is clearly established. The starting point and destination are then plotted in relationship to each other. If the terrain and enemy situations permit, the ideal course is a straight line from starting point to destination. This is seldom possible or practicable. The route of

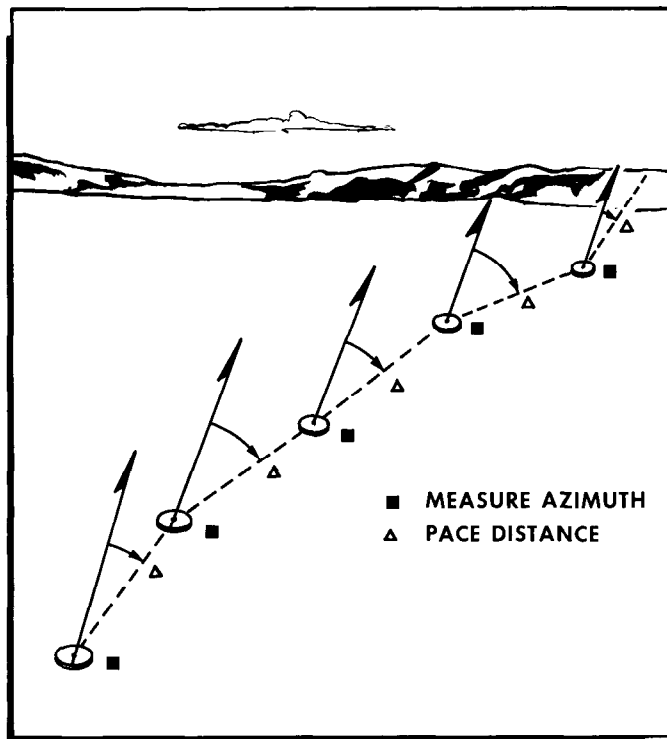

Figure 20-73. Compass Navigation on Foot.

1	2	3	4	5	6	7
ODOMETER READING AT START OF EACH COURSE	DISTANCE IN MILES	FORWARD AZIMUTH (MAGNETIC)	DECLINATION CORRECTION	DEVIATION CORRECTION	TRUE AZIMUTH	NOTES
A 4750						
	6	17°	13°	+3°	33°	
B 4756						
	9	358°	"	+2°	13°	
C 4765						
	8	341°	"	+1°	355°	
D 4773						
	1	314°	"	0°	327°	
E 4774	1.5	341°	"	+1°	355°	
F 4775	1.5	322°	"	0°	335°	
G 4777	1	312°	"	0°	325°	
H 4778						
	12	300°	12°	-1°	311°	
I 4790						
	6	341°	"	+1°	354°	
J 4796						
	6	302°	"	-1°	313°	
K 4802						
	20	319°	"	0°	331°	
4810						Wahoo River
						Crossing
4814						Cut 2 miles
L 4824			Base Camp (data)			

Figure 20-74. Sample Log.

travel usually consists of several courses, with an azimuth established at the starting point for the first course to be followed. Distance measurement begins with the departure and continues through the first course until a change in direction is made. A new azimuth is established for the second course and the distance is measured until a second change of direction is made, and so on. Records of all data are kept and all positions are plotted.

(c) A pace (for our purposes) is equal to the distance covered every time the same foot touches the ground (surveyor's paces). To measure distance, count the number of paces in a given course and convert to the map unit. Usually, paces are counted in hundreds, and hundreds can be kept track of in many ways: mak-

ing notes in a record book; counting individual fingers; placing small objects such as pebbles into an empty pocket; tying knots in a string; or using a mechanical hand counter. Distances measured this way are only approximate, but with practice can become very accurate. It is important that each person who uses dead reckoning navigation establish the length of an average pace. This is done by pacing a measured course many times and computing the mean (figure 20-73). In the field, an average pace must often be adjusted because of the following conditions:

-1. Slopes. The pace lengthens on a downgrade and shortens on an upgrade.

-2. Winds. A headwind shortens the pace while a tailwind increases it.

-3. Surfaces. Sand, gravel, mud and similar surface materials tend to shorten the pace.

-4. Elements. Snow, rain, or ice reduces the length of the pace.

-5. Clothing. Excess weight of clothing shortens the pace while the type of shoes affects traction and therefore the pace length.

(d) A log (figure 20-74) should be used for navigation, by dead reckoning, to record all of the distances and azimuths while traveling. Often, relatively short stretches of travel cannot be traversed in a straight course because of some natural features such as a river, or a steep, rugged slope. This break in normal navigation is shown on the log to ensure proper plotting.

(e) The course of travel may be plotted directly on the face of the map or on a separate piece of paper at the same scale as the map. If the latter method is chosen, the complete plot can be transferred to the map sheet, if at least one point of the plot is also shown on the map. The actual plotting can be done by protractor and scale. The degree of accuracy obtained depends upon the quality of draftmanship, the environmental conditions, and the care taken in obtaining data while en

route. Figure 20-75 illustrates a paper plot of the data obtained for the log sample in figure 20-74. It should be noted that four of the courses from A to H are short and have been plotted as a single course, equal to the sum of the four distances and using a mean azimuth of the four. This is recommended because it saves time without a loss of accuracy. If possible, a plot should be tied into at least one known intermediate point along the route. This is done by directing the route to pass near or over a point. If the plotted position of the intermediate point differs from its known location, discard the previous plot and start a new plot from the true location. The previous plot may be inspected to see if there is a detectable constant error applicable to future plots; otherwise, it is of no further use.

(f) An offset is a planned magnetic deviation to the right or left of an azimuth to an objective. It is used when approaching a linear feature from the side, and a point along the linear feature (such as a road junction) is the objective. Because of errors in the compass, or in map reading, one may reach the linear feature and not know whether the objective lies to the right or left. A deliberate offset by a known number of degrees in a known direction compensates for possible errors and ensures that, upon reaching the linear feature, the user knows whether to go right or left to reach the objective.

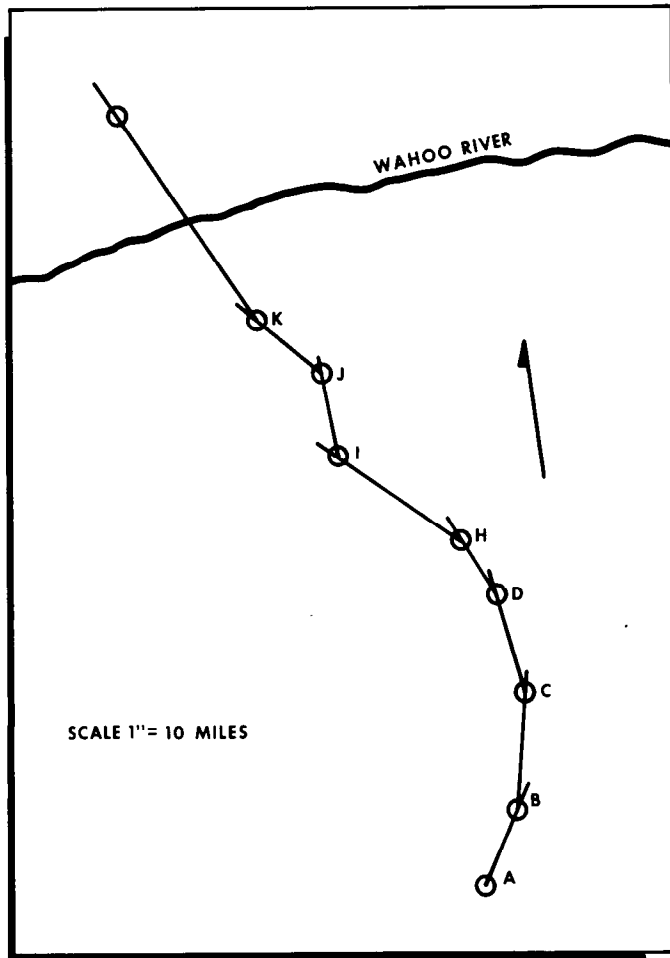

Figure 20-75. Separate Paper Plot.

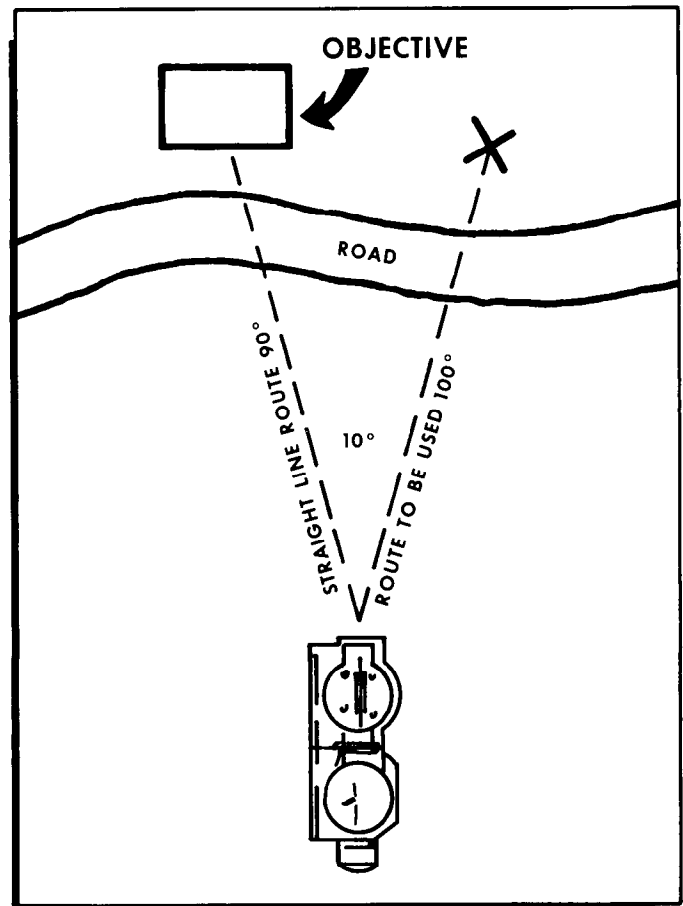

Figure 20-76. Deliberate Offset.

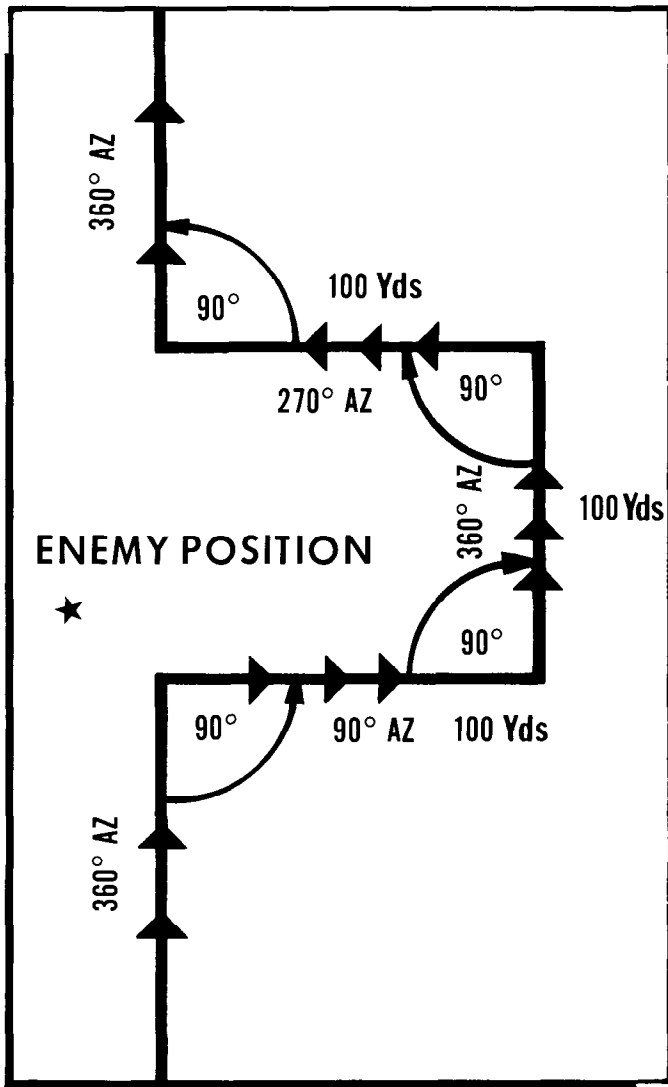

Figure 20-77. Detour Around Enemy Position.

Figure 20-76 shows an example of the use of offset to approach an objective. It should be remembered that the distance from "X" to the objective will vary directly with the distance to be traveled and the number of degrees offset. Each degree offset will move the course about 20 feet to the right or left for each 1,000 feet traveled. For example: In figure 20-76, the number of degrees offset is 10 to the right. If the distance traveled to "X" is 1,000 feet, then "X" is located about 200 feet to the right of the objective.

(g) Figure 20-77 shows an example of how to bypass enemy positions or obstacles by detouring around them and maintaining orientation by moving at right angles for specified distances; for example, moving on an azimuth 360° and wish to bypass an obstacle or position. Change direction to 90° and travel for 100 yards, change direction back to 360° and travel for 100 yards, change direction to 270° and travel for 100 yards, then change direction to 360°, and back on the

original azimuth. Bypassing an unexpected obstacle at night is done in the same way.

(12) Polar Coordinates:

(a) A point on the map may be determined or plotted from a known point by giving a direction and a distance along the direction line. This method of point location uses polar coordinates (figure 20-78). The reference direction is normally expressed as an azimuth, and the distance is determined by any convenient unit of measurement such as meters or yards.

(b) Polar coordinates are especially useful in the field because magnetic azimuth is determined from the compass and the distance can be estimated.

(13) Position Determination:

(a) Determining Latitude. (From the Sun at sunrise and sunset), Figure 20-79 shows the true azimuth of the rising Sun and the relative bearing of the setting Sun for all of the months in the year in the Northern and Southern Hemispheres (the table assumes a level horizon and is inaccurate in mountainous terrain).

-1. Latitude can be determined by using a compass to find the angle of the Sun at sunrise or sunset (subtracting or adding magnetic variation) and the date. According to the chart in figure 20-79, on January 26th, the azimuth of the rising Sun will be 120° to the left when facing the Sun in the Northern Hemisphere (it would be 120° to the right for setting Sun); therefore, the latitude would be 50°. If in the Southern Hemisphere, the direction of the Sun would be the opposite.

-2. The table does not list every day of the year, nor does it list every degree of latitude. If accuracy is desired within 1° of azimuth, interpolation may be nec-

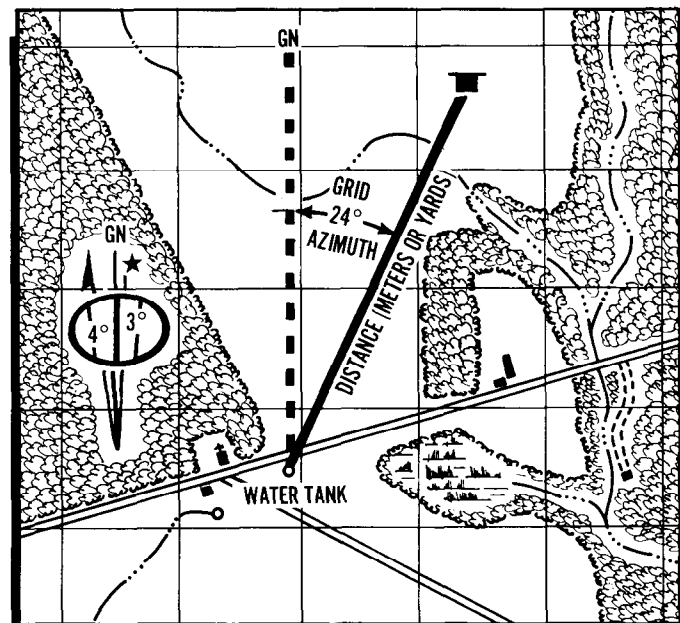
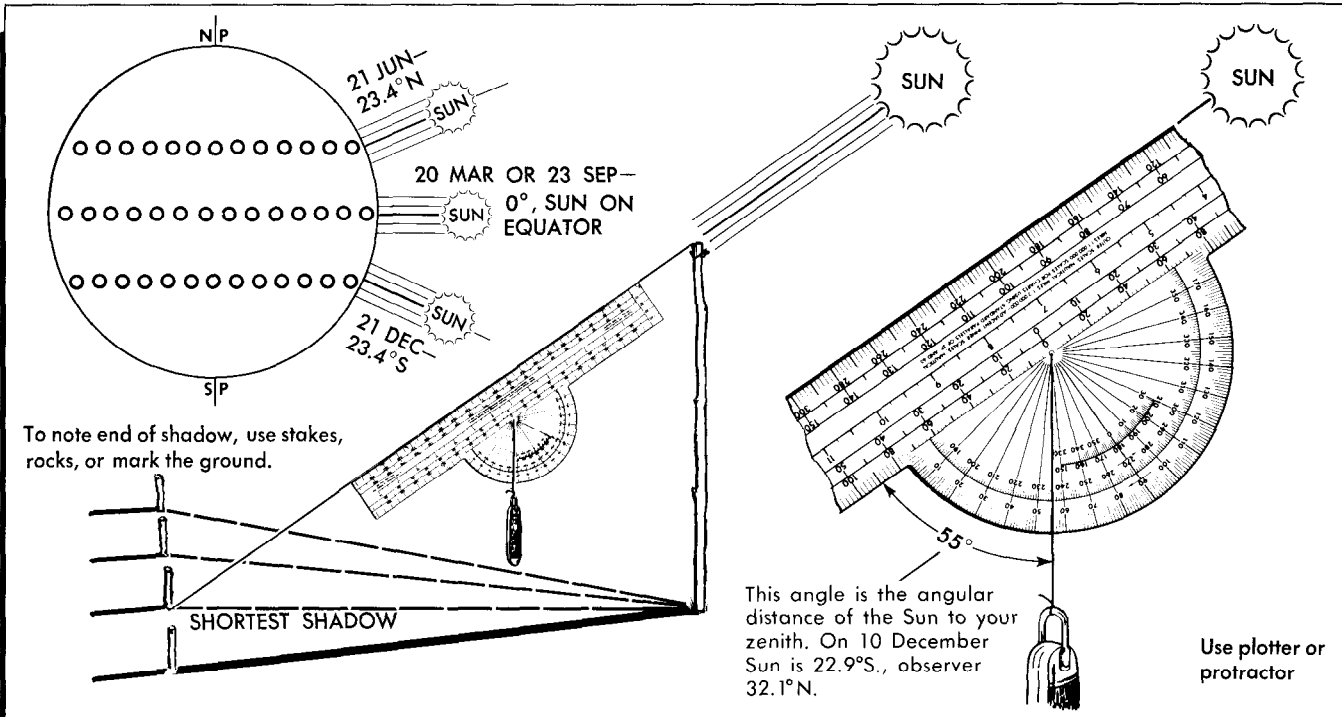

Figure 20-78. Polar Coordinates Used to Designate Position on Map.

DATE		Angle to North from the rising or setting Sun (level terrain)												
		LATITUDE												
		0°	5°	10°	15°	20°	25°	30°	35°	40°	45°	50°	55°	60°
JANUARY	1	113	113	113	114	115	116	117	118	121	124	127	133	141
	6	112	113	113	113	114	115	116	118	120	123	127	132	140
	11	112	112	112	113	113	114	115	117	119	122	125	130	138
	16	111	111	111	112	112	113	114	116	118	120	124	129	136
FEBRUARY	1	110	110	110	111	111	112	113	115	117	119	122	127	133
	6	109	109	109	109	110	111	112	113	115	117	120	124	130
	11	107	107	108	108	108	109	110	111	113	115	117	121	126
	16	104	104	105	105	105	106	107	108	109	110	112	116	120
MARCH	1	103	103	103	103	103	104	105	106	107	108	110	112	116
	6	101	101	101	101	101	102	102	103	104	105	107	109	112
	11	99	99	99	99	99	100	100	101	102	103	104	106	108
	16	98	98	98	98	99	99	99	100	100	101	102	104	106
APRIL	1	96	96	96	96	96	96	97	97	98	98	99	100	102
	6	94	94	94	94	94	94	95	95	95	96	96	97	98
	11	92	92	92	92	92	92	92	92	93	93	93	93	94
	16	90	90	90	90	90	90	90	90	90	90	90	90	90
MAY	1	88	88	88	88	88	88	88	88	87	87	87	87	86
	6	86	86	86	86	85	85	85	85	84	84	83	82	81
	11	84	84	84	83	83	83	83	82	82	81	80	79	77
	16	82	82	82	82	81	81	81	80	80	79	77	76	74
JUNE	1	80	80	80	80	79	79	78	78	77	76	74	72	70
	6	78	78	78	78	78	77	76	76	75	73	72	69	66
	11	77	77	76	76	76	75	75	74	72	71	69	66	63
	16	75	75	75	74	74	73	73	72	70	69	66	63	59
JULY	1	74	74	73	73	73	72	71	70	68	67	64	61	56
	6	72	72	72	72	71	70	69	68	67	65	63	60	55
	11	71	71	71	70	70	69	68	67	65	63	60	55	49
	16	70	70	70	69	69	68	67	65	63	61	58	53	47
AUGUST	1	69	69	69	68	68	67	66	64	62	60	56	51	44
	6	68	68	68	67	66	66	64	63	61	58	54	49	41
	11	67	67	67	66	65	64	63	62	59	56	53	47	39
	16	67	67	67	66	65	64	63	62	59	56	53	47	39
SEPTEMBER	1	67	67	67	66	65	64	63	62	59	56	53	47	39
	6	67	67	67	66	66	65	64	62	60	57	53	48	40
	11	68	68	68	67	66	65	64	63	61	58	54	49	41
	16	69	68	68	68	67	66	65	64	62	59	55	50	43
OCTOBER	1	69	69	69	69	68	67	66	65	63	60	57	52	45
	6	70	70	70	70	69	68	67	66	64	62	59	54	48
	11	72	72	72	71	71	70	69	68	66	64	61	57	51
	16	73	73	73	73	72	71	71	69	68	66	63	60	55
NOVEMBER	1	75	75	74	74	74	73	72	71	70	68	66	63	58
	6	76	76	76	76	75	75	74	73	72	70	68	65	61
	11	78	78	77	77	77	76	76	75	74	72	71	68	65
	16	79	79	79	79	79	78	78	77	76	75	73	71	68
DECEMBER	1	82	82	82	81	81	81	80	80	79	78	77	75	73
	6	83	83	83	83	83	83	82	82	81	81	80	78	77
	11	85	85	85	85	85	85	85	84	84	83	83	82	81
	16	87	87	87	87	87	87	87	86	86	86	85	85	84
JANUARY	1	89	89	89	89	89	89	89	89	89	89	88	88	88
	6	91	91	91	91	91	91	91	91	91	91	92	92	92
	11	93	93	93	93	93	93	93	94	94	94	95	95	96
	16	95	95	95	95	95	95	96	96	96	97	97	98	99
FEBRUARY	1	97	97	97	97	97	98	98	99	99	100	101	102	104
	6	99	99	99	99	99	100	100	101	101	102	104	105	108
	11	101	101	101	101	101	102	102	103	104	105	107	109	112
	16	102	102	103	103	103	104	104	105	106	108	109	112	115
MARCH	1	104	104	105	105	105	106	107	108	109	110	113	116	120
	6	106	106	106	107	107	108	109	110	111	113	115	119	123
	11	107	107	108	108	108	109	110	111	113	115	117	121	126
	16	109	109	109	109	110	111	112	113	115	117	120	124	130
APRIL	1	110	110	110	111	111	112	113	114	116	119	122	126	133
	6	111	111	111	112	112	113	114	116	118	120	124	128	135
	11	112	112	112	113	113	114	115	117	119	122	125	130	138
	16	113	113	113	114	115	116	117	118	121	124	127	133	141
MAY	1	113	113	113	114	115	116	117	118	121	124	127	133	141
	6	112	112	113	113	114	115	116	118	120	123	126	132	140
	11	113	113	113	114	115	116	117	118	121	124	127	133	141
	16	113	113	113	114	115	116	117	118	121	124	127	133	141

NOTE: When the Sun is rising, the angle is reckoned from East to North.  
When the Sun is setting, the angle is reckoned from West to North.

Figure 20-79. Finding Direction from the Rising or Setting Sun.



**DECLINATION OF SUN**

(IN DEGREES AND TENTHS OF A DEGREE)

Declination is tabulated to the nearest tenth of a degree rather than to the nearest minute of arc. To convert 1/10° (0.1°) to minutes, multiply by 6. (ie. 27.9° = 27° 54')

DAY	JAN	FEB	MAR	APR	MAY	JUN	JUL	AUG	SEP	OCT	NOV	DEC
1	S 23.1	S 17.5	S 7.7	N 4.4	N 15.0	N 22.0	N 23.1	N 18.1	N 8.4	S 3.1	S 14.3	S 21.8
2	23.0	17.2	7.3	4.8	15.3	22.1	23.1	17.9	8.1	3.4	14.6	21.9
3	22.9	16.9	6.9	5.2	15.6	22.3	23.0	17.6	7.7	3.8	15.0	22.1
4	22.9	16.6	6.6	5.6	15.9	22.4	22.9	17.3	7.3	4.2	15.3	22.2
5	22.8	16.3	6.2	5.9	16.2	22.5	22.8	17.1	7.0	4.6	15.6	22.3
6	S 22.7	S 16.0	S 5.8	N 6.3	N 16.4	N 22.6	N 22.7	N 16.8	N 6.6	S 5.0	S 15.9	S 22.5
7	22.5	15.7	5.4	6.7	16.7	22.7	22.6	16.5	6.2	5.4	16.2	22.6
8	22.4	15.4	5.0	7.1	17.0	22.8	22.5	16.3	5.8	5.7	16.5	22.7
9	22.3	15.1	4.6	7.4	17.3	22.9	22.4	16.0	5.5	6.1	16.8	22.8
10	22.2	14.8	4.2	7.8	17.5	23.0	22.3	15.7	5.1	6.5	17.1	22.9
11	S 22.0	S 14.5	S 3.8	N 8.2	N 17.8	N 23.1	N 22.2	N 15.4	N 4.7	S 6.9	S 17.3	S 23.0
12	21.9	14.1	3.5	8.6	18.0	23.1	22.0	15.1	4.3	7.3	17.6	23.1
13	21.7	13.8	3.1	8.9	18.3	23.2	21.9	14.8	3.9	7.6	17.9	23.1
14	21.5	13.5	2.7	9.3	18.5	23.2	21.7	14.5	3.6	8.0	18.1	23.2
15	21.4	13.1	2.3	9.6	18.8	23.3	21.6	14.2	3.2	8.4	18.4	23.3
16	S 21.2	S 12.8	S 1.9	N 10.0	N 19.0	N 23.3	N 21.4	N 13.9	N 2.8	S 8.8	S 18.7	S 23.3
17	21.0	12.4	1.5	10.4	19.2	23.4	21.3	13.5	2.4	9.1	18.9	23.3
18	20.8	12.1	1.1	10.7	19.5	23.4	21.1	13.2	2.0	9.5	19.1	23.4
19	20.6	11.7	0.7	11.1	19.7	23.4	20.9	12.9	1.6	9.9	19.4	23.4
20	20.4	11.4	0.3	11.4	19.9	23.4	20.7	12.6	1.2	10.2	19.6	23.4
21	S 20.2	S 11.0	N 0.1	N 11.7	N 20.1	N 23.4	N 20.5	N 12.2	N 0.8	S 10.6	S 19.8	S 23.4
22	20.0	10.7	0.5	12.1	20.3	23.4	20.4	11.9	0.5	10.9	20.1	23.4
23	19.8	10.3	0.9	12.4	20.5	23.4	20.2	11.6	N 0.1	11.3	20.3	23.4
24	19.5	9.9	1.3	12.7	20.7	23.4	20.0	11.2	S 0.3	11.6	20.5	23.4
25	19.3	9.6	1.7	13.1	20.9	23.4	19.7	10.9	0.7	12.0	20.7	23.4
26	S 19.0	S 9.2	N 2.1	N 13.4	N 21.1	N 23.4	N 19.5	N 10.5	S 1.1	S 12.3	S 20.9	S 23.4
27	18.8	8.8	2.5	13.7	21.2	23.3	19.3	10.2	1.5	12.7	21.1	23.3
28	18.5	8.5	2.9	14.0	21.4	23.3	19.1	9.8	1.9	13.0	21.3	23.3
29	18.3	8.1	3.2	14.4	21.6	23.3	18.8	9.5	2.3	13.3	21.4	23.3
30	18.0	...	3.6	14.7	21.7	23.2	18.6	9.1	2.7	13.7	21.6	23.2
31	S 17.7	...	N 4.0	...	N 21.9	...	N 18.4	N 8.8	...	S 14.0	...	S 23.1

EXAMPLE: On 10 December the declination of the Sun is 22.9°S., so observers who measure the zenith distance as 0° would know that they are at latitude 22.9°S. If they measure a zenith distance

of 5° with the Sun south of this zenith, they are 5° north of 22.9°S, or at a latitude 17.9°S; and if the Sun is north, they are 5° south of 22.9°S, or latitude 27.9°S.

Figure 20-80. Determining Latitude by Noon Sun.

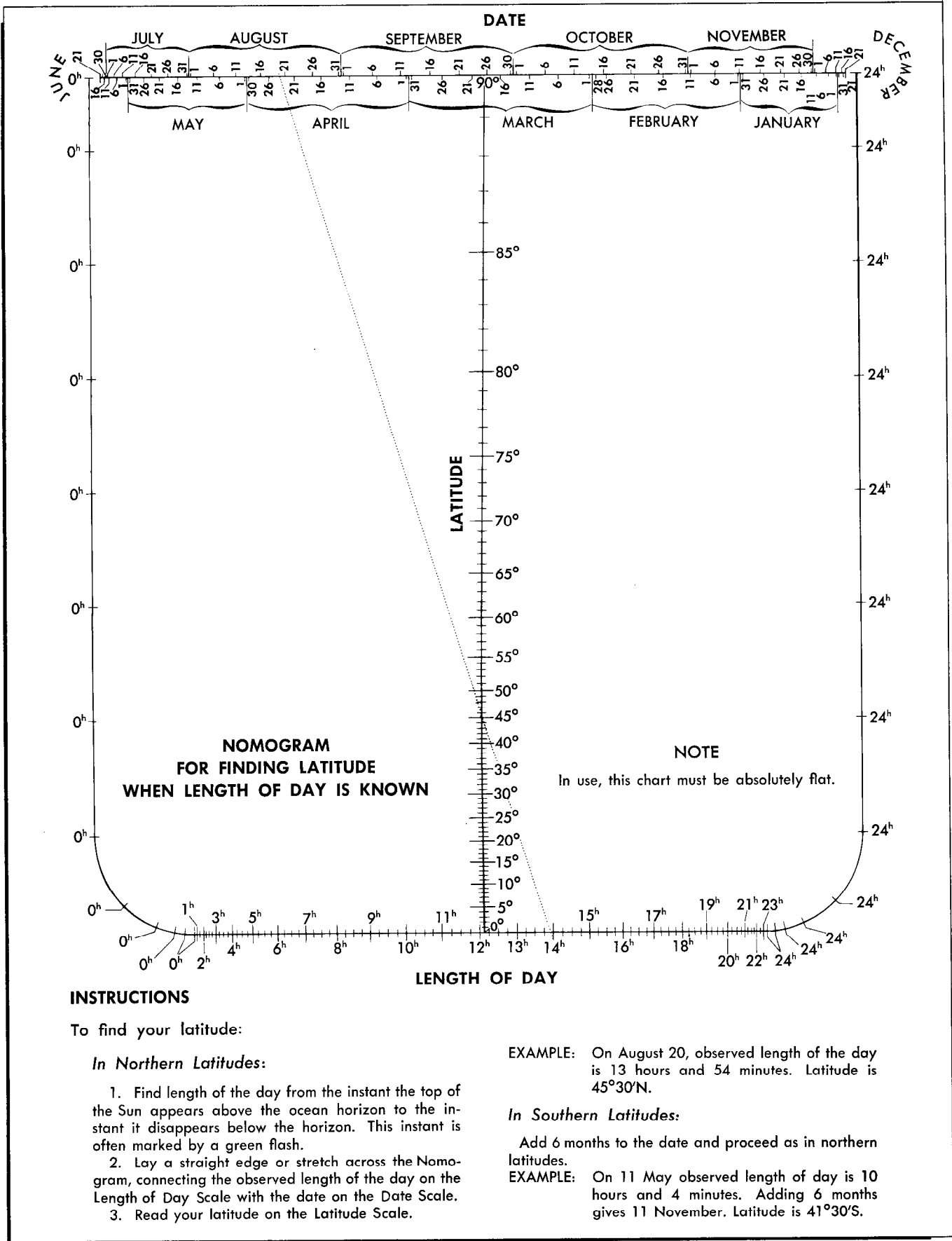

Figure 20-81. Nomogram.



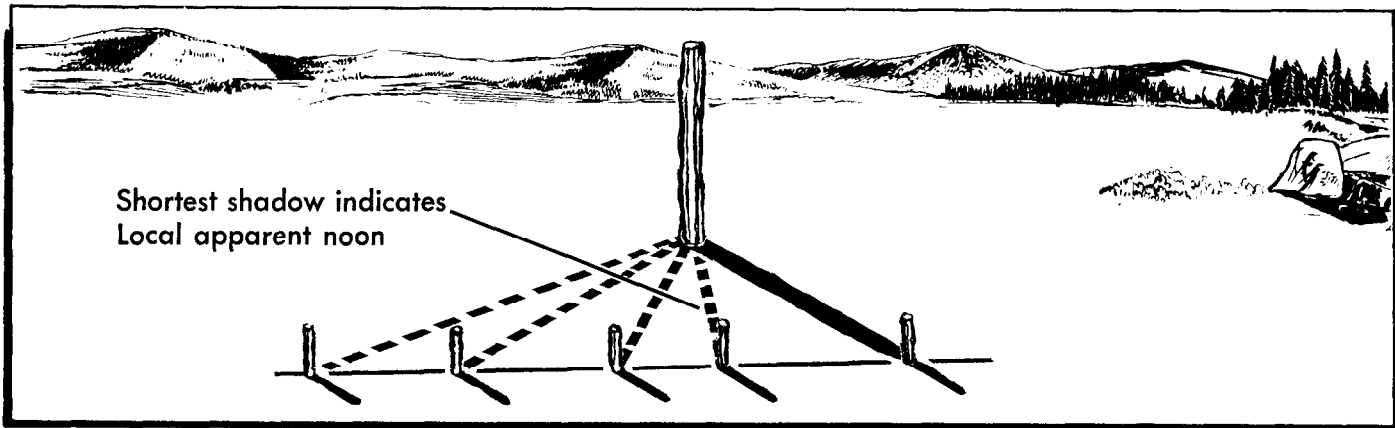

Figure 20-82. Stick and Shadow.

essary (split the difference) between the values given in the table. For example, between 45° latitude and 50° latitude is 5°. The difference in latitudes (5°) and the difference in azimuths (3°) split ( $\frac{5}{3}$ ) is  $1\frac{2}{3}$ ' ( $1^{\circ}40'$ ), so the more accurate degree of latitude would be 46°40' latitude.

(b) Latitude by Noon Altitude of the Sun. On any given day, there is only one latitude on Earth where the Sun passes directly overhead or through the zenith at noon. In all latitudes north of this, the Sun passes to the south of the zenith; and in those south of it, the Sun passes to the north. For each 1° change of latitude, the zenith distance also changes by 1 degree. Figure 20-80 gives the latitude for each day of the year where the Sun is in the zenith at noon. If a Weems plotter or other protractor is available, maximum altitude of the Sun should be used to find latitude by measuring the angular distance of the Sun from the zenith at noon. Local noon can be found using the methods described earlier. Stretch a string from the top of a stick to the point

where the end of the noon shadow rested, place the plotter along the string and drop a plumb line from the center of the plotter. The intersection of the plumb line with the outer scale of the plotter shows the angular distance of the Sun from the zenith.

(c) Latitudes by Length of Day. This method is used most effectively while on open seas. When in any latitude between 60°N and 60°S, the exact latitude within 30 nautical miles ( $\frac{1}{2}^{\circ}$ ) can be determined if the length of the day within 1 minute is known. This is true throughout the year except for about 10 days before and 10 after the equinoxes—approximately 11-31 March and 12 September-2 October. During these two periods, the day is about the same length at all latitudes. A level horizon is required to time sunrise and sunset accurately. Find the length of day from the instant the top of the Sun first appears above the ocean horizon to the instant it disappears below the horizon. This instant is often marked by a green flash. Write down the times of sunrise and sunset. Don't count on remembering them.

Date	Eq. of Time*	Date	Eq. of Time*	Date	Eq. of Time*	Date	Eq. of Time*	Date	Eq. of Time*	Date	Eq. of Time*
Jan. 1	-3.5 min.	Mar. 4	-12.0	May 2	+3.0 min.	Aug. 4	-6.0	Oct. 1	+10.0 min.	Dec. 1	+11.0
2	-4.0	8	-11.0	14	+3.8	12	-5.0	4	+11.0	4	+10.0
4	-5.0	12	-10.0	May 28	+3.0	17	-4.0	7	+12.0	6	+9.0
7	-6.0	16	-9.0	June 4	+2.0	22	-3.0	11	+13.0	9	+8.0
9	-7.0	19	-8.0	9	+1.0	Aug. 26	-2.0	15	+14.0	11	+7.0
12	-8.0	22	-7.0	14	0.0	Aug. 29	-1.0	20	+15.0	13	+6.0
14	-9.0	26	-6.0	19	-1.0	Sept. 1	0.0	Oct. 27	+16.0	15	+5.0
17	-10.0	Mar. 29	-5.0	23	-2.0	5	+1.0	17	+4.0	19	+3.0
20	-11.0	Apr. 1	-4.0	June 28	-3.0	8	+2.0	Nov. 4	+16.4	21	+2.0
24	-12.0	5	-3.0	July 3	-4.0	10	+3.0	11	+16.0	23	+1.0
Jan. 28	-13.0	8	-2.0	9	-5.0	13	+4.0	17	+15.0	25	0.0
Feb. 4	-14.0	12	-1.0	18	-6.0	16	+5.0	22	+14.0	27	-1.0
13	-14.3	16	0.0	July 27	-6.6	19	+6.0	25	+13.0	29	-2.0
19	-14.0	20	+1.0	Aug. 4	+9.0	22	+7.0	Nov. 28	+12.0	Dec. 31	-3.0
Feb. 28	-13.0	Apr. 25	+2.0	Sept. 28	+9.0	25	+8.0				

\* Add plus values to mean time and subtract minus values from mean time to get apparent time.

Figure 20-83. Equation of Time.

Note that only the length of day counts in the determination of latitude; a watch may have an unknown error and yet serve to determine this factor. If only one water horizon is available, as on a seacoast, find local noon by the stick and shadow method. The length of day is twice the interval from sunrise to noon or from noon to sunset. Knowing the length of day, latitude can be found by using the nomogram shown in figure 20-81.

(d) Longitude from Local Apparent Noon. To find longitude, a survivor must know the correct time and the rate at which a watch gains or loses time. If this rate and the time the watch was last set is known, the correct time can be computed by adding or subtracting the gain or loss. Correct the zone time on the watch to Greenwich time; for example, if the watch is on eastern standard time, add 5 hours to get Greenwich time. Longitude can be determined by timing the moment a celestial body passes the meridian. The easiest body to use is the Sun. Use one of the following methods:

-1. Stick and Shadow. Put up a stick or rod (figure 20-82) as nearly vertical as possible in a level place. Check the alignment of the stick by sighting along the line of a makeshift plumb bob. (To make a plumb bob, tie any heavy object to a string and let it hang free. The line of the string indicates the vertical.) Sometime before midday, begin marking the position of the end of the stick's shadow. Note the time for each mark. Continue marking until the shadow definitely lengthens. The time of the shortest shadow is the time when the Sun passed the local meridian or local apparent noon. A survivor will probably have to estimate the position of

the shortest shadow by finding a line midway between two shadows of equal length, one before noon and one after. If the times of sunrise and sunset are accurately determined on a water horizon, local noon will be midway between these times.

-2. Double Plumb Bob. Erect two plumb bobs about 1 foot apart so that both strings line up on Polaris, much the same as a gun sight. Plumb bobs should be set up when Polaris is on the meridian and has no east-west correction. The next day, when the shadows of the two plumb bobs coincide, they will indicate local apparent noon.

-3. Mark Down the Greenwich Time of Local Apparent Noon. The next step is to correct this observed time of meridian passage for the equation of time; that is, the number of minutes the real Sun is ahead of or behind the mean Sun. (The mean Sun was invented by astronomers to simplify the problems of measuring time. Mean Sun rolls along the Equator at a constant rate of 15° per hour. The real Sun is not so considerate; it changes its angular rate of travel around the Earth with the seasons.) Figure 20-83 gives the value in minutes of time to be added to or subtracted from mean (watch) time to get apparent (Sun) time.

-4. After computing the Greenwich time of local noon, the difference of longitude between the survivor's position and Greenwich can be found by converting the interval between 1200 Greenwich and the local noon from time to arc. Remember that 1 hour equals 15° of longitude, 4 minutes equal 1° of longitude, and 4 seconds equal 1' of longitude. Example: The

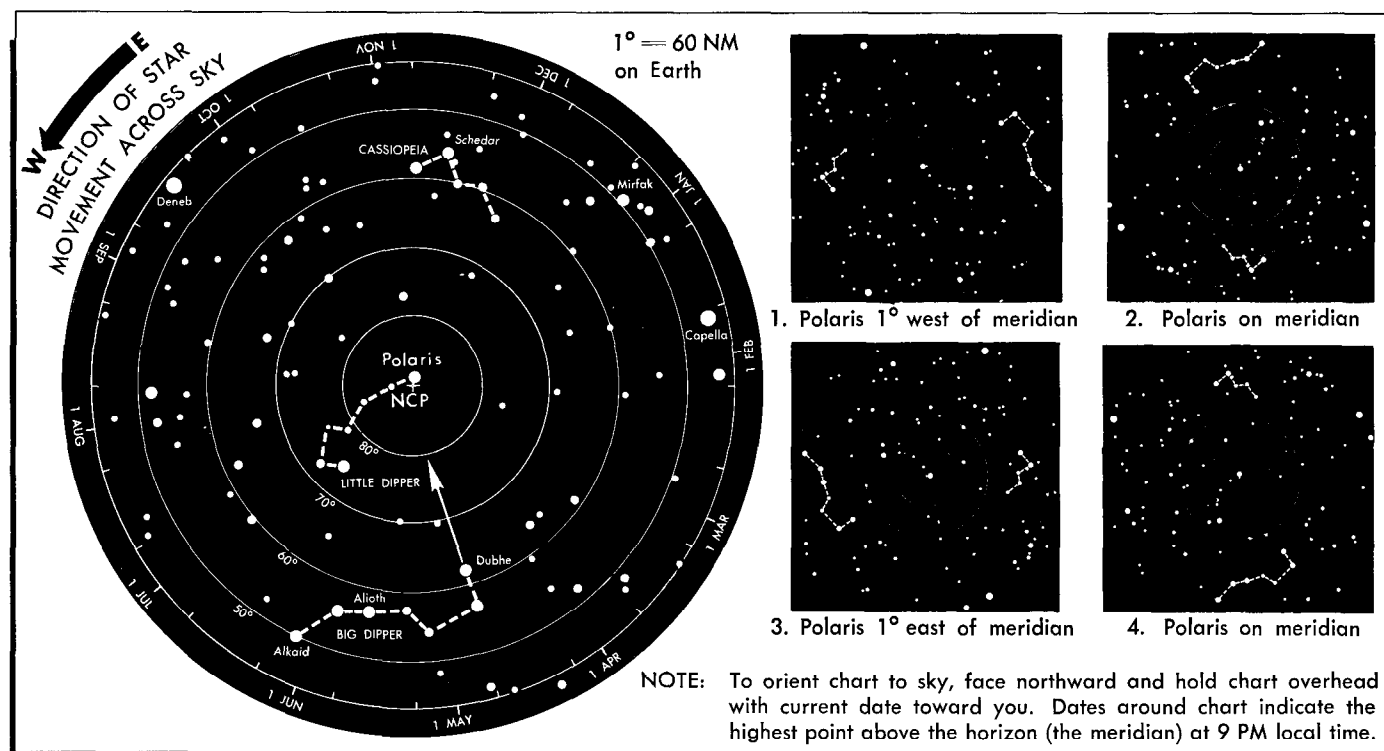

Figure 20-84. Finding Direction from Polaris.

survivor's watch is on eastern standard time, and it normally loses 30 seconds a day. It hasn't been set for 4 days. The local noon is timed at 15:08 on the watch on 4 February. Watch correction is 4 X 30 seconds, or plus 2 minutes. Zone time correction is plus 5 hours. Greenwich time is 15:08 plus 2 minutes plus 5 hours or 20:10. The equation of time for 4 February is minus 14 minutes. Local noon is 20:10 minus 14 minutes or 19:56 Greenwich. The difference in time between Greenwich and present position is 19:56 minus 12:00 or 7:56. A time of 7:56 equals 119° of longitude. Since local noon is later than Greenwich noon, the survivor is west of Greenwich, longitude is 119°W.

(e) Direction and Position Finding at Night:

-1. Direction from Polaris. In the Northern Hemisphere, one star, Polaris (the Pole Star), is never more than approximately 1° from the North Celestial Pole. In other words, the line from any observer in the Northern Hemisphere to the Pole Star is never more than 1° away from true north. Find the Pole Star by locating the Big Dipper or Cassiopeia, two groups of stars which are very close to the North Celestial Pole. The two stars on the outer edge of the Big Dipper are called pointers because they point almost directly to Polaris. If the pointers are obscured by clouds, Polaris can be identified by its relationship to the constellation Cassiopeia. Figure 20-84 indicates the relation between the Big Dipper, Polaris, and Cassiopeia.

-2. Direction from the Southern Cross. In the Southern Hemisphere, Polaris is not visible. There the Southern Cross is the most distinctive constellation.

When flying south, the Southern Cross appears shortly before Polaris drops from sight astern. An imaginary line through the long axis of the Southern Cross, or True Cross, points toward the South Pole. The True Cross should not be confused with a larger cross nearby known as the False Cross, which is less bright and more widely spaced. Two of the four stars in the True Cross are among the brightest stars in the heavens; they are the stars on the southern and eastern arms. Those of the northern and western arms are not as conspicuous but are bright.

-3. There is no conspicuous star above the South Pole to correspond to Polaris above the North Pole. In fact, the point where such a star would be, if one existed, lies in a region devoid of stars. This point is so dark in comparison with the rest of the sky that it is known as the Coalsack. Figure 20-85 shows the True Cross and—to the west of it—the False Cross.

(f) Finding Due East and West by Equatorial Stars. Due to the altitude of Polaris above the horizon, it may sometimes be difficult to use as a bearing. To use a point directly on the horizon may be more convenient.

-1. The celestial equator, which is a projection of the Earth's equator onto the imaginary celestial sphere, always intersects the horizon line at the due east and west points of the compass. Therefore, any star on the celestial equator rises due east and sets due west (disallowing a small error because of atmospheric refraction). This holds true for all latitudes except those of the North and South Poles, where the celestial equator

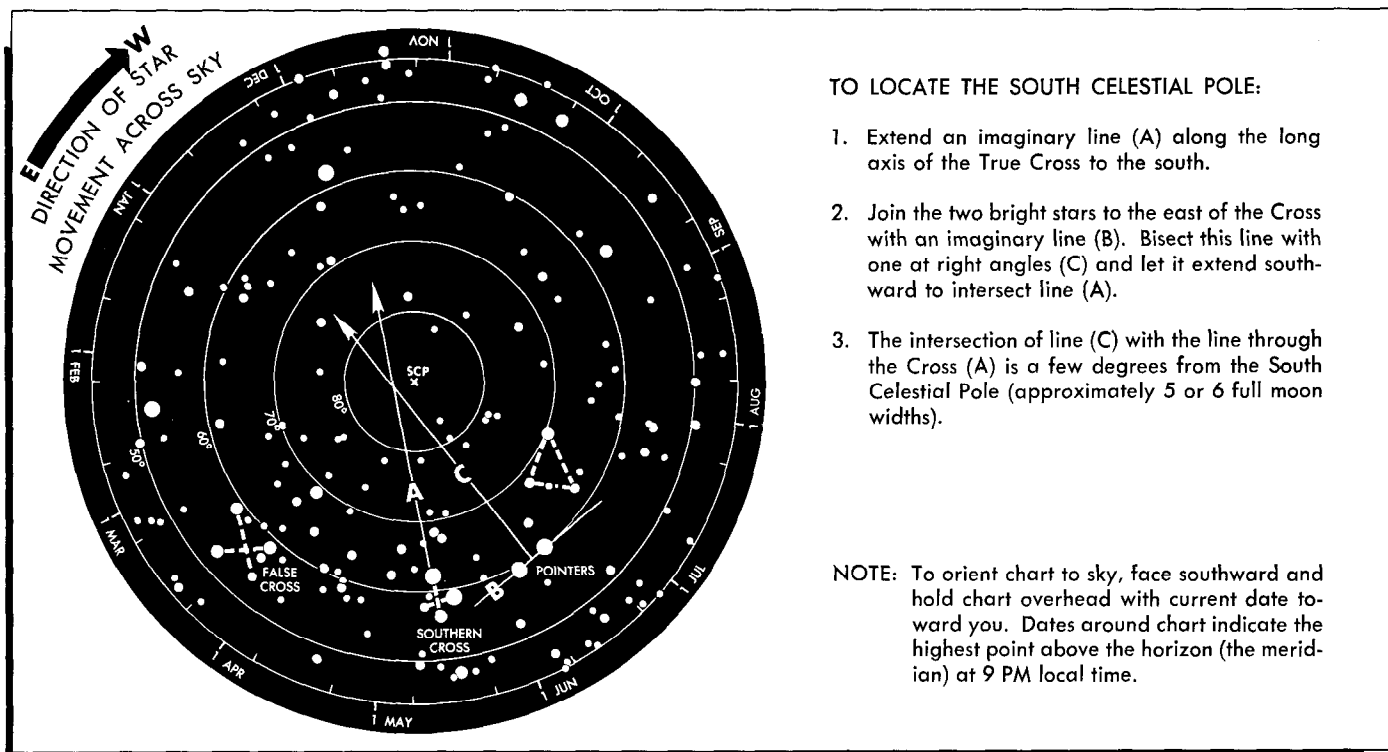

Figure 20-85. Finding Direction from Southern Cross.

and the horizon have a common plane. However, if a survivor is at the North or South Pole, it will probably be known, so this technique can be assumed to be of universal use.

-2. Certain difficulties arise in the practical use of this technique. Unless a survivor is quite familiar with the constellations, it may be difficult to spot a specific rising star as it first appears above the eastern horizon. It will probably be simpler to depend upon the identification of an equatorial star before it sets in the west.

-3. Another problem is caused by atmospheric extinction. As stars near the horizon, they grow fainter in brightness because the line of sight between the observer's eyes and the star passes through a constantly thickening atmosphere. Therefore, faint stars disappear from view before they actually set. However, a fairly accurate estimate of the setting point of a star can be made some time before it actually sets. The atmospheric conditions of the area have a great effect on obstructing a star's light as it sets. Atmospheric haze, for example, is much less a problem on deserts than along temperate zone coastal strips.

-4. Figure 20-86 shows the brighter stars and some prominent star groups which lie along the celestial equator. There are few bright stars actually on the celestial equator. However, there are a number of stars which lie quite near it, so an approximation within a degree or so can be made. Also, a rough knowledge of the more conspicuous equatorial constellations will give the survivor a continuing checkpoint for maintaining orientation.

(g) Finding Latitude from Polaris. A survivor can find the latitude in the Northern Hemisphere north of 10°N by measuring the angular altitude of Polaris above the horizon, as shown in figure 20-87.

(h) Finding Direction (North) from Overhead Stars that are not in the General Location of the Celestial Poles:

-1. At times, survivors may not be able to locate Polaris (the North Star) due to partial cloud cover, or its position below the observer's horizon. In this situation, it would seem that survivors would be unable to locate direction. Fortunately, survivors who wish to initially find direction or who wish to check a course of

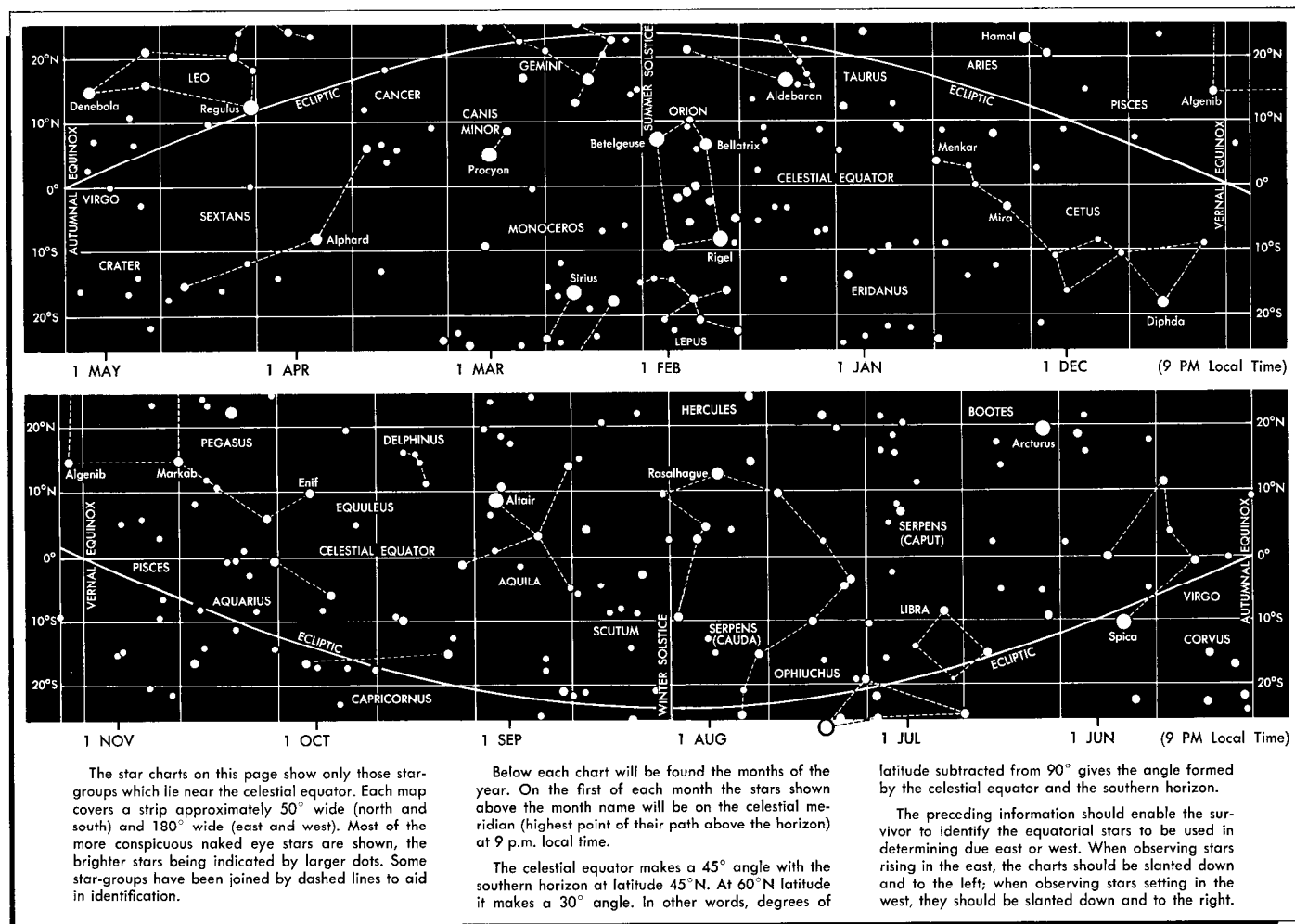
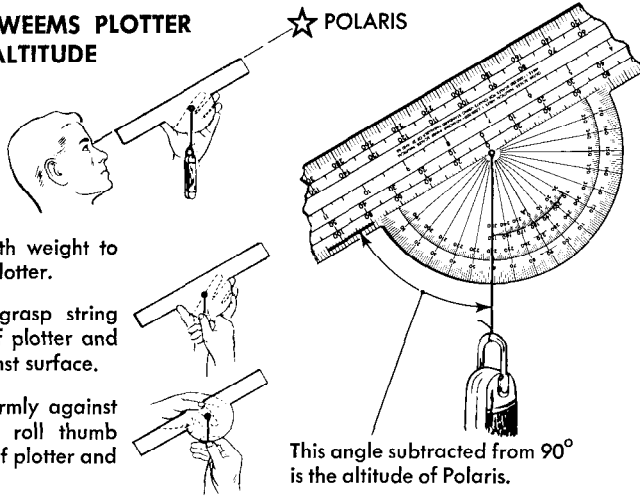

Figure 20-86. Charts of Equatorial Stars.

**HOW TO USE WEEMS PLOTTER TO MEASURE ALTITUDE OF POLARIS**



1. Attach string with weight to center hole of plotter.
2. After sighting, grasp string at outer edge of plotter and hold firmly against surface.
3. Holding string firmly against face of plotter, roll thumb under the edge of plotter and take reading.

This angle subtracted from 90° is the altitude of Polaris.

**HOW TO USE ANY PROTRACTOR TO MEASURE ALTITUDE OF POLARIS**

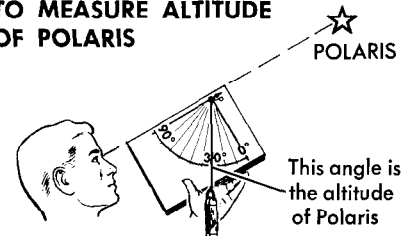

Any protractor (such as the one printed in AFM 64-5) can be used to find latitude.

1. Attach string with weight to Point "P".
2. After sighting, grasp string at edge of protractor.
3. Hold string in this position and take reading. This gives the altitude of Polaris.

**CORRECTION FOR OBSERVED ALTITUDE OF POLARIS**

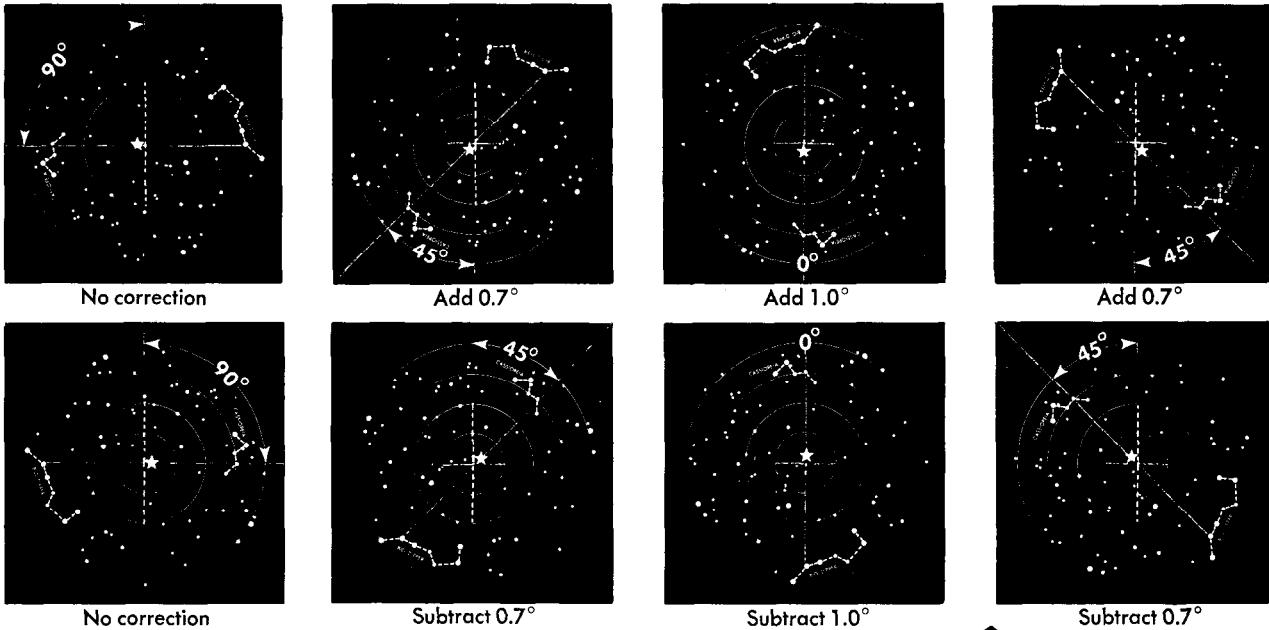

The star diagrams above are drawn for angles of 0°, 45°, and 90° between the vertical dotted line through the pole and the line through Cassiopeia and the Big Dipper (Ursa Major). For intermediate positions the angle may be estimated and the correction taken from the Correction Table. Subtract corrections given in the table when Polaris is above the horizontal line through the pole and add corrections when Polaris is below this line.

Note that the correction changes very slowly near the time when the correction is greatest and hence an error in estimation of the position has little effect at this time.

CORRECTION TABLE			
ANGLE	CORRECTION	ANGLE	CORRECTION
0°	1.0°	50°	0.6°
10°	1.0°	60°	0.5°
20°	0.9°	70°	0.3°
30°	0.9°	80°	0.2°
40°	0.8°	90°	No correction

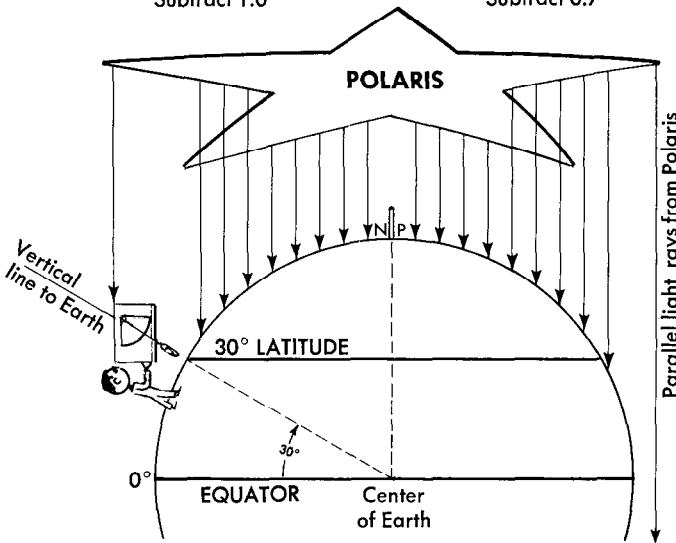

Figure 20-87. Finding Latitude by Polaris.

travel during the night need not worry about being lost or unable to travel if Polaris cannot be identified.

-2. The following is an adaptation of the stick and shadow method of direction finding. This method is based on the principles that all the heavenly bodies (Sun, Moon, planets, and stars) rise (generally) in the east and set (generally) in the west. This technique can be used anywhere on Earth with any stars except those which are circumpolar. Circumpolar stars are those which appear to travel around Polaris instead of apparently "moving" from east to west.

-3. To use this technique, survivors should keep in mind that they may use *any star other than a circumpolar one*.

-4. Survivors who wish to know general direction must prepare a device to aid them. This can be done by placing a stick (about 5 feet in length) at a slight angle in the ground in an open area (figure 20-88). Thin material (suspension line, string, vine, braided cloth, etc.) is then attached to the tip of the stick. This material should be longer than what is required to reach the ground (figure 20-88).

-5. The survivor should lie on the back with the head next to this hanging line and pull the cord up to the temple area and hold it tautly.

-6. Next, the survivor moves around on the ground until the taut line is pointing directly at the selected, bright, noncircumpolar star (or planet).

-7. The taut line is now in position to simulate the star's (or planet's) shadow. Survivors should remember that this method of finding direction is an adaptation of the Sun, stick, and shadow approach. Here the more distant stars and (or) planets take the place of our Sun. Since these objects are too distant from the Earth to create shadow, the string represents the shadow.

-8. With the taut line simulating the star's shadow, survivors should mark the point on the ground where the line touches with a stick, stone, etc. The survivor should repeat this sighting on the same star (or planet) after about 15 to 20 minutes (marking the spot at which the line "shadow" touches the ground). A line scribed on the ground which connects these two points will run west-east (as the stars and planets move from east to west, the "shadow" will move in the opposite direction). The first mark will be in the west. Drawing a line perpendicular to the west-east line, a survivor will have a north-south line and be able to travel.

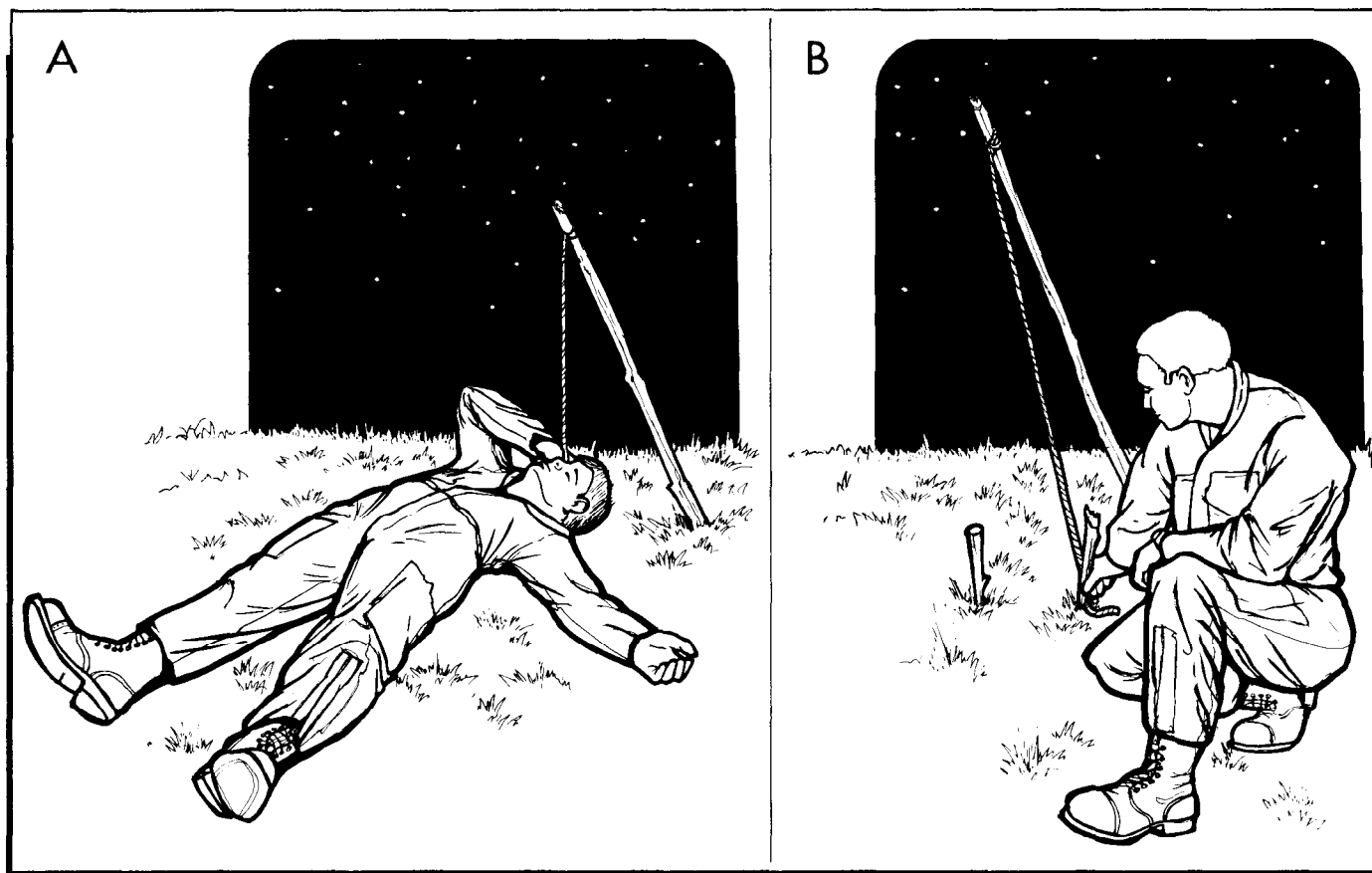

Figure 20-88. Stick and String Direction Finding.