

Hydraulic Design Manual

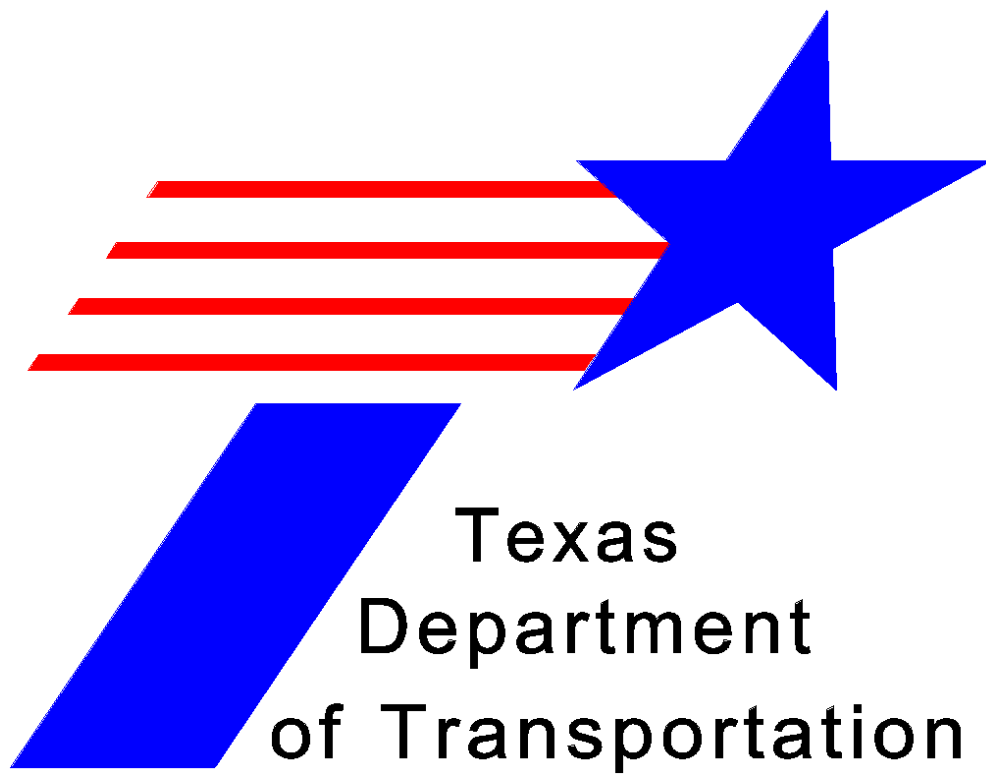

Texas
Department
of Transportation

Revised October 2011

© 2011 by Texas Department of Transportation
(512) 302-2453 all rights reserved

Manual Notice 2011-1

From: Mark A. Marek, P.E.

Manual: *Hydraulic Design Manual*

Effective Date: October 01, 2011

Purpose

This manual provides guidance and recommended procedures for the design of Texas Department of Transportation drainage facilities. This revision reorganizes and updates the manual content to reflect current policies and to incorporate recent research in the field of hydrology and hydraulics. It also updates examples, streamlines the organization of the manual, and corrects minor errors.

Contents

The first 5 chapters are completely new chapters. Chapters 6 through 14 are existing chapters in which information has been updated or rearranged, and irrelevant material has been removed. Changes to Chapters 6, 7 and 14 are relatively minor.

Chapter 1 - Manual Introduction

- ◆ Presents organization of the manual and introductory material.

Chapter 2 - Hydraulic Practices and Governing Law

- ◆ Lists the various federal and state laws, regulations, and agencies to be considered in hydraulic design
- ◆ Provides definitions of policy, standards, and other items, as well as details of the roles and responsibilities in hydraulic design
- ◆ Provides guidance for responding to drainage complaints, connection to TxDOT structures, and dams.

Chapter 3 - Processes and Procedures in TxDOT Hydrologic and Hydraulic Activities

- ◆ Provides guidance on the scope of hydraulic activities, evaluation of risk in hydraulic design, and design activities by project phase from initial planning through PS&E development
- ◆ Provides guidance on hydraulic documentation and deliverables, including a comprehensive table of the data or documentation, the stage at which it's needed, and where the data is to be stored
- ◆ Section on Risk has been moved from Chapter 9 (Bridges) to apply to all designs, not just bridges.

Chapter 4 - Hydrology

- ◆ Contains new information and procedures based on recent research
- ◆ The existing information has been reorganized, outdated information has been removed, and references have been updated.

Chapter 5 - NFIP Design of Floodplain Encroachments and Cross Drainage Structures

- ◆ Provides a description of the National Flood Insurance Program (NFIP), definitions, guidance on TxDOT's responsibility under the NFIP, and detailed procedures for hydraulic designers.

Chapter 6 - Hydraulic Principles

- ◆ Provides an expanded definition of Froude Number with a discussion on its meaning and importance.

Chapter 7 - Channels

- ◆ Reformatted to improve reader's comprehension
- ◆ Corrects, and updates information; supplementary information has been removed.

Chapter 8 - Culverts

- ◆ The chapter has been reformatted to improve reader's comprehension
- ◆ Information has been corrected, updated, new information added, and supplementary information has been removed.

Chapter 9 - Bridges

- ◆ The chapter has been reformatted to improve reader's comprehension
- ◆ Information has been corrected, updated, new information added, and supplementary information has been removed
- ◆ Bridge scour section has been removed and inserted in the Bridge Division Geotechnical Manual. The Geotechnical section is the OPR for bridge scour
- ◆ Moved section on Risk to Chapter 3 to apply to all designs, not just bridges.

Chapter 10 - Storm Drains

This chapter has not been altered at this time. It will be addressed in the next revision.

Chapter 11 - Pump Stations

- ◆ The chapter has been rewritten with new information
- ◆ Information deemed supplementary has been removed.

Chapter 12 - Reservoirs

- ◆ The chapter has been reformatted to improve reader's comprehension
- ◆ Information has been corrected, updated, new information added, and supplementary information has been removed.

Chapter 13 - Storm Water Management

- ◆ The chapter has been reformatted to improve reader's comprehension
- ◆ Information has been corrected, updated, some new information added, and supplementary information has been removed
- ◆ Further revision is anticipated because of pending environmental regulations and the implementation of a TxDOT-wide EMS program.

Chapter 14 - Conduit Strength and Durability

- ◆ This chapter has been removed from this manual; questions regarding this subject can be addressed by the Bridge Division.

Contact

Address questions concerning the information contained in this manual to the Roadway Design Section in the Design Division.

Copyright Notice

This *Hydraulic Design Manual* and all future revisions: Copyright ©2011 by Texas Department of Transportation (TxDOT). Published by the Design Division (DES). All rights reserved.

Archives

Past manual notices are available in a [PDF archive](#).

Table of Contents

Chapter 1 — Manual Introduction

Section 1 — About this Manual	1-2
Purpose	1-2
Conventions and Assumptions	1-2
Organization	1-2
Feedback	1-3
Section 2 — Introduction to Hydraulic Analysis and Design	1-4

Chapter 2 — Hydraulic Practices and Governing Law

Section 1 — Overview	2-2
Section 2 — Federal Laws, Regulations, and Agencies Governing Hydraulic Design	2-3
National Flood Insurance Program	2-3
Executive Order 11988	2-4
National Environmental Policy Act	2-4
Rivers and Harbors Act	2-4
Clean Water Act	2-5
23 Code of Federal Regulations 650 Subpart A	2-6
23 Code of Federal Regulations 650 Subparts C and H	2-6
Memoranda of Understanding (Federal)	2-7
Section 3 — State Statutes and Rules Governing Hydraulic Design	2-8
Texas Water Code Chapter 11	2-8
Texas Water Code Chapter 16 Subchapter I	2-8
Title 30 Texas Administrative Code Chapter 299	2-9
Title 43 Texas Administrative Code Rule 15.54(e)	2-9
Memoranda of Understanding (State)	2-9
Texas Executive Order D.B. No. 34	2-10
Section 4 — Policies, Standard Practices, Requirements, and Guidance	2-11
Section 5 — Roles and Responsibilities for Hydraulic Analysis and Design	2-12
Area/ Design Office Engineers	2-12
TxDOT Contract Managers	2-13
TxDOT Project Managers	2-13
District Hydraulics Engineers	2-13
Design Division Hydraulics Branch (DES-HYD)	2-14
Section 6 — Local Agency Ordinances and Requirements	2-16
Section 7 — Responding to Drainage Complaints	2-17
Section 8 — Developments Connecting into TxDOT Hydraulic Structures	2-18
Section 9 — Dams	2-19

Chapter 3 — Processes and Procedures in TxDOT Hydrologic and Hydraulic Activities

Section 1 — Overview	3-2
Section 2 — Scope of Hydrologic and Hydraulic Activities	3-3
Hydraulic Considerations for Rehabilitated Structures	3-3
Hydraulic Considerations for New Structures	3-4
Section 3 — Evaluation of Risk	3-5
Risk Assessment Forms	3-6
Section 4 — Design Activities by Project Phase	3-7
Planning and Programming	3-7
Preliminary Design	3-7
Environmental	3-8
PS&E Development	3-9
Section 5 — Documentation and Deliverables	3-10
Key Elements of Hydraulic Documentation	3-10
Special Documentation Requirements for Projects crossing NFIP designated SFHA	3-11
Permanent Retention of Documentation	3-11
Documentation Reference Tables	3-11

Chapter 4 — Hydrology

Section 1 — Hydrology’s Role in Hydraulic Design	4-2
Section 2 — Probability of Exceedance	4-3
Annual Exceedance Probability (AEP)	4-3
Design AEP	4-3
Section 3 — Hydrology Policies and Standards	4-6
General Guidelines	4-6
Third Party Studies	4-6
Hydraulic Design for Existing Land Use Conditions	4-6
Effect on Existing Facilities	4-7
Section 4 — Hydrology Study Requirements	4-8
Section 5 — Hydrology Study Data Requirements	4-9
Hydrology Analysis Methods	4-9
Data Requirements Vary with Method Used	4-9
Geographic and Geometric Properties of the Watershed	4-10
Land Use, Natural Storage, Vegetative Cover, and Soil Property Information	4-10
Description of the Drainage Features of the Watershed	4-11
Rainfall Observations and Statistics of the Precipitation	4-11
Streamflow Observations and Statistics of the Streamflow	4-12
Section 6 — Design Flood and Check Flood Standards	4-13
Section 7 — Selection of the Appropriate Method for Calculating Runoff	4-16

Section 8 — Validation of Results from the Chosen Method	4-19
Section 9 — Statistical Analysis of Stream Gauge Data	4-21
Data Requirements for Statistical Analysis	4-21
Log-Pearson Type III Distribution Fitting Procedure	4-22
Skew	4-25
Accommodation of Outliers	4-27
Transposition of Gauge Analysis Results	4-29
Section 10 — Regression Equations Method	4-31
Procedure for Using Omega EM Regression Equations for Natural Basins	4-31
Section 11 — Time of Concentration	4-36
Kerby-Kirpich Method	4-36
The Kerby Method	4-37
The Kirpich Method	4-39
Application of the Kerby-Kirpich Method	4-39
Natural Resources Conservation Service (NRCS) Method for Estimating t_c	4-40
Sheet Flow Time Calculation	4-41
Shallow Concentrated Flow	4-42
Channel Flow	4-42
Manning’s Roughness Coefficient Values	4-43
Section 12 — Rational Method	4-47
Assumptions and Limitations	4-47
Procedure for using the Rational Method	4-48
Runoff Coefficients	4-49
Section 13 — Hydrograph Method	4-54
Design Storm Development	4-56
Rainfall Temporal Distribution	4-62
Models for Estimating Losses	4-77
Section 14 — References	4-120
Section 15 — Glossary of Hydrology Terms	4-123
Annual Exceedance Probability (AEP)	4-123
Annual Flood	4-123
Annual Flood Series	4-123
Antecedent Conditions	4-123
Area-Capacity Curve	4-123
Attenuation	4-123
Backwater	4-123
Bank	4-123
Bank Storage	4-124
Bankfull Stage	4-124

Base Discharge (for peak discharge)	4-124
Baseflow	4-124
Basic Hydrologic Data	4-124
Basic-Stage Flood Series.	4-124
Bifurcation.	4-124
Binomial Statistical Distribution.	4-124
Boundary Condition	4-125
Calibration.	4-125
Canopy-Interception	4-125
Channel (watercourse).	4-125
Channel Storage	4-125
Computation Duration.	4-125
Computation Interval.	4-125
Concentration Time.	4-125
Confluence	4-126
Continuous Model.	4-126
Correlation.	4-126
Dendritic	4-126
Depression Storage	4-126
Design Flood.	4-126
Design Storm.	4-126
Detention Basin.	4-126
Diffusion	4-126
Direct Runoff.	4-127
Discharge.	4-127
Discharge Rating Curve	4-127
Distribution Graph (distribution hydrograph).	4-127
Diversions	4-128
Drainage Area	4-128
Drainage Divide	4-128
Duration Curve	4-128
ET	4-128
Effective Precipitation (rainfall)	4-128
Evaporation	4-128
Evaporation Demand.	4-128
Evaporation Pan	4-129
Evaporation, Total.	4-129
Evapotranspiration	4-129
Event-Based Model.	4-129
Exceedance Probability.	4-129

Excess Precipitation	4-129
Excessive Rainfall	4-129
Falling Limb	4-130
Field Capacity	4-130
Field-Moisture Deficiency	4-130
Flood	4-130
Flood Crest	4-130
Flood Event	4-130
Flood Peak	4-130
Floodplain	4-130
Flood Profile	4-131
Flood Routing	4-131
Flood Stage	4-131
Flood Wave	4-131
Flood, Maximum Probable	4-131
Flood-Frequency Curve	4-131
Floodway	4-132
Flow-Duration Curve	4-132
Gauging Station	4-132
Ground Water	4-132
Groundwater Outflow	4-132
Groundwater Runoff	4-132
Hydraulic Radius	4-132
Hydrograph	4-133
Hydrologic Budget	4-133
Hydrologic Cycle	4-133
Hydrology	4-133
Hyetograph	4-133
Index Precipitation	4-133
Infiltration	4-133
Infiltration Capacity	4-133
Infiltration Index	4-133
Inflection Point	4-134
Initial Condition	4-134
Interception	4-134
Isohyetal Line	4-134
Lag	4-134
Lag Time	4-134
Loss	4-134
Mass Curve	4-134

Maximum Probable Flood	4-134
Meander	4-135
Model	4-135
Moisture	4-135
Objective Function	4-135
Overland Flow	4-135
Parameter	4-135
Parameter Estimation	4-135
Partial-Duration Flood Series	4-135
Peak Flow	4-136
Peak Stage	4-136
Percolation	4-136
PMF	4-136
Precipitation	4-136
Precipitation, Probable Maximum	4-136
Probability of Capacity Exceedance	4-136
Probability of Exceedance	4-136
Rain	4-137
Rainfall	4-137
Rainfall Excess	4-137
Rating Curve	4-137
Reach	4-137
Recession Curve	4-137
Recurrence Interval (return period)	4-137
Regulation, Regulated	4-137
Reservoir	4-137
Residual-Mass Curve	4-138
Retention Basin	4-138
Rising Limb	4-138
Runoff	4-138
Saturation Zone	4-138
NRCS Curve Number	4-138
Snow	4-138
Soil Moisture Accounting (SMA)	4-138
Soil Moisture (soil water)	4-139
Soil Profile	4-139
Stage	4-139
Stage-Capacity Curve	4-139
Stage-Discharge Curve (rating curve)	4-139
Stage-Discharge Relation	4-139

Stemflow	4-139
Storage	4-139
Storm	4-140
Stream	4-140
Stream Gauging	4-140
Streamflow	4-140
Stream-Gauging Station	4-140
Sublimation	4-140
Surface Runoff	4-140
Surface Water	4-141
Tension Zone	4-141
Time of Concentration	4-141
Time of Rise	4-141
Time to Peak	4-141
TR-20	4-141
TR-55	4-141
Transpiration	4-142
Underflow	4-142
Unit Hydrograph	4-142
Vadose Zone	4-142
Water Year	4-142
Watershed	4-142
WinTR-55	4-142

Chapter 5 — NFIP Design of Floodplain Encroachments & Cross Drainage Structures

Section 1 — The National Flood Insurance Program (NFIP)	5-2
Section 2 — Definitions	5-3
Types of Flood Zones (Risk Flood Insurance Zone Designations)	5-4
Section 3 — NFIP Roles	5-5
Participation	5-5
Floodplain Administrator	5-5
Texas	5-5
Non-participating Communities	5-6
Section 4 — TxDOT and the NFIP	5-7
Texas and the NFIP	5-7
TxDOT and Local Floodplain Regulations	5-7
Permits versus FPA Notification	5-8
Hydraulic Structures versus Insurable Structures	5-8
Section 5 — Hydrologic and Hydraulic Studies	5-10

Before starting the design	5-10
If the project is within a participating community	5-10
If the project is within or crossing an SFHA.	5-10
Section 6 — Hydrologic and Hydraulic Results	5-14
Changes to the BFE.	5-14
Range of Frequencies	5-14
Conditional Letter Of Map Revision (CLOMR)/Letter Of Map Revision (LOMR)	5-14
FPA Notification Details.	5-16
Communities Without an FPA	5-16

Chapter 6 — Hydraulic Principles

Section 1 — Open Channel Flow	6-2
Introduction	6-2
Continuity and Velocity	6-2
Channel Capacity	6-2
Conveyance	6-4
Energy Equations	6-4
Energy Balance Equation	6-7
Depth of Flow	6-8
Froude Number	6-9
Flow Types	6-9
Cross Sections	6-10
Roughness Coefficients.	6-11
Subdividing Cross Sections.	6-12
Importance of Correct Subdivision	6-13
Section 2 — Flow in Conduits.	6-18
Open Channel Flow or Pressure Flow.	6-18
Depth in Conduits	6-18
Roughness Coefficients.	6-19
Energy	6-20
Steep Slope versus Mild Slope	6-21
Section 3 — Hydraulic Grade Line Analysis	6-22
Introduction	6-22
Hydraulic Grade Line Considerations.	6-22
Stage versus Discharge Relation.	6-23
Conservation of Energy Calculation	6-24
Minor Energy Loss Attributions	6-24
Entrance Control	6-24
Hydraulic Grade Line Procedure.	6-25

Chapter 7 — Channels

Section 1 — Introduction	7-2
Open Channel Types	7-2
Methods Used for Depth of Flow Calculations	7-2
Section 2 — Stream Channel Planning Considerations and Design Criteria	7-3
Location Alternative Considerations	7-3
Phase Planning Assessments	7-3
Environmental Assessments	7-4
Consultations with Respective Agencies	7-4
Stream Channel Criteria	7-5
Section 3 — Roadside Channel Design	7-7
Roadside Drainage Channels	7-7
Channel Linings	7-7
Rigid versus Flexible Lining	7-7
Channel Lining Design Procedure	7-9
Trial Runs	7-13
Section 4 — Stream Stability Issues	7-14
Stream Geomorphology	7-14
Stream Classification	7-15
Modification to Meandering	7-18
Graded Stream and Poised Stream Modification	7-18
Modification Guidelines	7-18
Realignment Evaluation Procedure	7-19
Response Possibilities and Solutions	7-19
Environmental Mitigation Measures	7-21
Countermeasures	7-22
Altered Stream Sinuosity	7-24
Stabilization and Bank Protection	7-25
Revetments	7-26
Section 5 — Channel Analysis Guidelines	7-28
Stage-Discharge Relationship	7-28
Switchback	7-29
Section 6 — Channel Analysis Methods	7-30
Introduction	7-30
Slope Conveyance Method	7-30
Slope Conveyance Procedure	7-31
Standard Step Backwater Method	7-34
Standard Step Data Requirements	7-34
Standard Step Procedure	7-35

Profile Convergence	7-37
---------------------------	------

Chapter 8 — Culverts

Section 1 — Introduction	8-2
Definition and Purpose	8-2
Construction	8-3
Inlets	8-4
Section 2 — Design Considerations	8-5
Economics	8-5
Site Data	8-5
Culvert Location	8-6
Waterway Considerations	8-7
Roadway Data	8-7
Allowable Headwater	8-8
Outlet Velocity	8-9
End Treatments	8-10
Traffic Safety	8-10
Culvert Selection	8-13
Culvert Shapes	8-14
Multiple Barrel Boxes	8-15
Design versus Analysis	8-15
Culvert Design Process	8-16
Design Guidelines and Procedure for Culverts	8-16
Section 3 — Hydraulic Operation of Culverts	8-22
Parameters	8-22
Headwater under Inlet Control	8-22
Headwater under Outlet Control	8-25
Energy Losses through Conduit	8-27
Free Surface Flow (Type A)	8-28
Full Flow in Conduit (Type B)	8-29
Full Flow at Outlet and Free Surface Flow at Inlet (Type BA)	8-30
Free Surface at Outlet and Full Flow at Inlet (Type AB)	8-31
Energy Balance at Inlet	8-32
Slug Flow	8-35
Determination of Outlet Velocity	8-35
Depth Estimation Approaches	8-36
Direct Step Backwater Method	8-36
Subcritical Flow and Steep Slope	8-38
Supercritical Flow and Steep Slope	8-39
Hydraulic Jump in Culverts	8-39

Sequent Depth	8-40
Roadway Overtopping	8-42
Performance Curves	8-45
Exit Loss Considerations	8-46
Section 4 — Improved Inlets	8-48
Inlet Use	8-48
Section 5 — Velocity Protection and Control Devices	8-50
Excess Velocity	8-50
Velocity Protection Devices	8-50
Velocity Control Devices	8-50
Broken Back Design and Provisions Procedure	8-52
Energy Dissipators	8-55
Section 6 — Special Applications	8-57
Detour Culverts	8-57
Risk	8-57
Engineering Requirements	8-59

Chapter 9 — Bridges

Section 1 — Introduction and Definitions	9-2
Hydraulically Designed Bridges	9-2
Section 2 — Planning and Location Considerations	9-3
Introduction	9-3
Location Selection and Orientation Guidelines	9-3
Environmental Considerations	9-4
Water Resource Development Projects	9-4
FEMA Designated Floodplains	9-4
Stream Characteristics	9-5
Procedure to Check Present Adequacy of Methods Used	9-5
Section 3 — Bridge Hydraulic Considerations	9-6
Bridge/Culvert Determination	9-6
Highway-Stream Crossing Analysis	9-6
Flow through Bridges	9-7
Backwater in Subcritical Flow	9-7
Allowable Backwater Due to Bridges	9-9
Flow Distribution	9-9
Velocity	9-10
Bridge Scour and Stream Degradation	9-11
Freeboard	9-12
Roadway/Bridge Profile	9-12

Crossing Profile.	9-14
Single versus Multiple Openings	9-15
Factors Affecting Bridge Length.	9-16
Section 4 — Hydraulics of Bridge Openings	9-17
Bridge Modeling Philosophy	9-17
Bridge Alignment	9-17
Flow Zones and Energy Losses.	9-17
Extent of Impact Determination	9-19
Water Surface Profile Calculations.	9-19
Bridge Flow Class	9-20
Zone 2 Loss Methods	9-20
Standard Step Backwater Method (used for Energy Balance Method computations).	9-21
Momentum Balance Method.	9-22
WSPRO Contraction Loss Method	9-24
Pressure Flow Method.	9-24
Empirical Energy Loss Method (HDS 1)	9-27
Two-dimensional Techniques	9-27
Roadway/Bridge Overflow Calculations	9-27
Backwater Calculations for Parallel Bridges	9-27
Section 5 — Single and Multiple Opening Designs	9-29
Introduction	9-29
Single Opening Design Guidelines	9-29
Multiple Opening Design Approach	9-30
Multiple Bridge Design Procedural Flowchart	9-31
Cumulative Conveyance Curve Construction	9-32
Bridge Sizing and Energy Grade Levels	9-32
Freeboard Evaluation	9-32
Section 6 — Flood Damage Prevention	9-34
Extent of Flood Damage Prevention Measures.	9-34
Pier Foundations	9-34
Approach Embankments	9-35
Abutments	9-35
Guide Banks (Spur Dikes).	9-36
Bank Stabilization and River Training Devices	9-37
Minimization of Hydraulic Forces and Debris Impact on the Superstructure	9-38
Section 7 — Appurtenances	9-40
Bridge Railing	9-40
Deck Drainage.	9-40

Chapter 10 — Storm Drains

Section 1 — Introduction	10-2
Overview of Urban Drainage Design	10-2
Overview of Storm Drain Design	10-2
Section 2 — System Planning and Design Considerations	10-4
Design Checklist	10-4
Problem Identification	10-4
Schematic	10-4
Material and Shape Selection	10-5
Design Criteria	10-6
Outfall Considerations and Features	10-7
Special Outfall Appurtenances	10-8
Utility Conflicts	10-8
Construction	10-9
Identification of Other Drainage Facilities	10-9
Design Documentation	10-10
Documentation Requirements	10-10
Section 3 — Runoff	10-12
Hydrologic Considerations for Storm Drain Systems	10-12
Flow Diversions	10-12
Detention	10-12
Determination of Runoff	10-13
Other Hydrologic Methods	10-13
Section 4 — Pavement Drainage	10-14
Design Objectives	10-14
Ponding	10-14
Transverse Slopes	10-15
Use of Rough Pavement Texture	10-15
Gutter Flow Design Equations	10-16
Ponding on Continuous Grades	10-18
Ponding at Approach to Sag Locations	10-18
Hydroplaning	10-19
Vehicle Speed in Relation to Hydroplaning	10-19
Water Depth in Relation to Hydroplaning	10-20
Section 5 — Storm Drain Inlets	10-22
Inlet Types	10-22
Curb Opening Inlets	10-22
Grate Inlets	10-23
Slotted Drains	10-24

Combination Inlets	10-26
Inlets in Sag Configurations	10-26
Median/Ditch Drains	10-27
Inlet Locations	10-28
Ponded Width Options	10-29
Carryover Design Approach	10-29
Curb Inlets On-Grade	10-30
Curb Inlets in Sag Configuration	10-35
Slotted Drain Inlet Design	10-37
Grate Inlets On-Grade	10-39
Bicycle Safety for Grate Inlets On-Grade	10-39
Design Procedure for Grate Inlets On-Grade	10-39
Design Procedure for Grate Inlets in Sag Configurations	10-42
Section 6 — Conduit Systems	10-44
Conduits	10-44
Manholes	10-45
Inverted Siphons	10-46
Conduit Capacity Equations	10-46
Conduit Design Procedure	10-47
Conduit Analysis	10-49
Section 7 — Conduit Systems Energy Losses	10-50
Minor Energy Loss Attributions	10-50
Junction Loss Equation	10-50
Exit Loss Equation	10-51
Manhole Loss Equations	10-51

Chapter 11 — Pump Stations

Section 1 — Introduction	11-2
Purpose of A Pump Station	11-2
Security and Access Considerations	11-2
Safety and Environmental Considerations	11-2
Section 2 — Pump Station Components	11-3
Overview of Components	11-3
Section 3 — Pump Station Hydrology	11-6
Methods for Design	11-6
Procedure to Determine Mass Inflow	11-6
Section 4 — Pump Station Hydraulic Design Procedure	11-9
Introduction	11-9
Storage Design Guidelines	11-9

Pump Selection	11-10
----------------------	-------

Chapter 12 — Reservoirs

Section 1 — Introduction.....	12-2
Section 2 — Coordination with Other Agencies.....	12-3
Reservoir Agencies	12-3
TxDOT Coordination	12-3
Section 3 — Reservoir Analysis Factors.....	12-4
Hydrology Methods.....	12-4
Flood Storage Potential.....	12-4
Reservoir Discharge Facilities	12-5
Section 4 — Highways Downstream of Dams	12-6
Peak Discharge	12-6
Scour Considerations.....	12-6
Design Adequacy	12-6
Section 5 — Highways Upstream of Dams.....	12-7
New Location Highways.....	12-7
Existing Highways	12-7
Minimum Top Establishment	12-7
Structure Location.....	12-8
Scour Considerations.....	12-9
Section 6 — Embankment Protection	12-10
Introduction.....	12-10
Embankment Protection Location.....	12-10
Rock Riprap.....	12-10
Soil-Cement Riprap.....	12-11
Articulated Riprap.....	12-12
Concrete Riprap.....	12-12
Vegetation.....	12-13

Chapter 13 — Storm Water Management

Section 1 — Introduction.....	13-2
Storm Water Management and Best Management Practices	13-2
Requirements for Construction Activities.....	13-3
Storm Drain Systems Requirements	13-3
Section 2 — Soil Erosion Control Considerations	13-4
Erosion Process.....	13-4
Natural Drainage Patterns	13-6
Stream Crossings.....	13-6

Encroachments on Streams	13-6
Public and Industrial Water Supplies and Watershed Areas	13-7
Geology and Soils	13-7
Coordination with Other Agencies	13-7
Roadway Guidelines	13-7
Severe Erosion Prevention in Earth Slopes	13-8
Channel and Chute Design	13-8
Section 3 — Inspection and Maintenance of Erosion Control Measures	13-10
Inspections	13-10
Embankments and Cut Slopes	13-10
Channels	13-10
Repair to Storm Damage	13-11
Erosion/Scour Problem Documentation	13-11
Section 4 — Quantity Management	13-12
Impacts of Increased Runoff	13-12
Storm Water Quantity Management Practices	13-12

Chapter 1 — Manual Introduction

Contents:

[Section 1 — About this Manual](#)

[Section 2 — Introduction to Hydraulic Analysis and Design](#)

Section 1 — About this Manual

Purpose

Hydraulic facilities include open channels, bridges, culverts, storm drains, pump stations, and storm-water quantity and quality control systems. Each can be part of a larger facility that drains water. In analyzing or designing drainage facilities, your investment of time, expense, concentration, and task completeness should be influenced by the relative importance of the facility. This manual provides procedures recommended by the Texas Department of Transportation (TxDOT) for analyzing and designing effective highway drainage facilities.

Conventions and Assumptions

This manual assumes that hydraulic designers have access to programmable calculators, computer spreadsheets, and specific hydraulic computer programs.

Organization

This manual is organized as follows:

- ◆ Chapter 1: Manual Introduction
- ◆ Chapter 2: Hydraulic Policy and Governing Law
- ◆ Chapter 3: Processes and Procedures in TxDOT Hydrologic and Hydraulic Activities
- ◆ Chapter 4: Hydrology
- ◆ Chapter 5: Federal Emergency Management Agency (FEMA) National Flood Insurance Program (NFIP) Compliant Design of Floodplain Encroachments and Minor Structures
- ◆ Chapter 6: Hydraulic Principles
- ◆ Chapter 7: Channels
- ◆ Chapter 8: Culverts
- ◆ Chapter 9: Bridges
- ◆ Chapter 10: Storm Drains
- ◆ Chapter 11: Pump Stations
- ◆ Chapter 12: Reservoirs
- ◆ Chapter 13: Storm Water Management

Feedback

Direct any questions or comments on the content of the manual to the Director of the Design Division, Texas Department of Transportation.

Section 2 — Introduction to Hydraulic Analysis and Design

The involvement of hydraulic engineers from the Design Division or at the district level should ideally begin in the project initiation phase of a project. In some cases such early involvement may not be justified or feasible. In all projects requiring any significant input from hydraulics, input should start no later than the beginning of planning phase. Hydraulic engineering input at the earliest stages of the project can help the project manager to anticipate important project elements that could impact the project cost or schedule. Examples of such elements include but are not limited to the following:

- ◆ Regulatory elements, such as [National Flood Insurance Program](#) (NFIP) floodways, that could impose significant constraints,
- ◆ Existing drainage structures (such as culverts) that are hydraulically inadequate and which may require complete replacement rather than mere extension as part of a widening project,
- ◆ Opportunities to avoid complete replacement of drainage structures through various types of rehabilitation,
- ◆ Fundamental hydraulic or stream stability problems at a proposed new stream crossing location,
- ◆ Upcoming or ongoing flood control projects by other parties that could improve or alter the drainage situation at a given location.

Hydraulic engineering expertise can be applied to a broad range of aspects of a TxDOT project including environmental documentation and mitigation, cross-drainage design, pavement drainage and storm drain design, detention facilities, storm water quality best management practices, and regulatory compliance. The types of projects requiring or benefiting from hydraulics input include:

- ◆ Highway widening or reconstruction
- ◆ Urban street reconstruction
- ◆ Intersection improvements
- ◆ Interchange addition or modifications
- ◆ Bridge replacements
- ◆ Constructing routes on new alignments
- ◆ Safety improvement projects
- ◆ Chronic maintenance problem remediation
- ◆ Pump stations
- ◆ Storm water quantity and quality control systems.

The hydraulic design or analysis of highway drainage facilities usually involves a general procedure, the specific components of which vary for each project. Some of the basic components inherent in the design or analysis of any highway drainage facility include data, surveys of existing characteristics, estimates of future characteristics, engineering design criteria, discharge estimates, structure requirements and constraints, and receiving facilities.

Time, expense, focus, and completeness of the design or analysis process should all be commensurate with the relative importance of the facility, that is, its cost, level of use, public safety, impact to adjacent lands, and similar factors. These aspects of the design process are often subjective. The funding or time constraints associated with any engineered project often are determining factors in the designer's involvement.

Chapter 2 — Hydraulic Practices and Governing Law

Contents:

[Section 1 — Overview](#)

[Section 2 — Federal Laws, Regulations, and Agencies Governing Hydraulic Design](#)

[Section 3 — State Statutes and Rules Governing Hydraulic Design](#)

[Section 4 — Policies, Standard Practices, Requirements, and Guidance](#)

[Section 5 — Roles and Responsibilities for Hydraulic Analysis and Design](#)

[Section 6 — Local Agency Ordinances and Requirements](#)

[Section 7 — Responding to Drainage Complaints](#)

[Section 8 — Developments Connecting into TxDOT Hydraulic Structures](#)

[Section 9 — Dams](#)

Section 1 — Overview

This chapter briefly describes the laws and related policies that affect hydraulic design for TxDOT projects. Federal and state regulations and rules have the force of law, and compliance is not at the discretion of TxDOT.

[Federal Highway Administration](#) (FHWA) sets forth policy and guidance in the [Federal Aid Policy Guide](#) (FAPG). The primary policy for drainage is 23 [Code of Federal Regulations](#) (CFR) 650, which is described later in this chapter.

Section 2 — Federal Laws, Regulations, and Agencies Governing Hydraulic Design

This section provides an overview of the federal regulatory environment as it relates to hydraulic considerations for TxDOT projects. It is not, however, an exhaustive list of all federal regulations that may pertain to highway drainage.

The following subsections discuss:

- ◆ National Flood Insurance Act
- ◆ Executive Order 11988
 - U.S. Department of Transportation Order 5650.2
- ◆ National Environmental Policy Act
- ◆ Rivers and Harbors Act
- ◆ Clean Water Act
 - Section 402 National Pollutant Discharge Elimination System
 - Section 404 Regulatory Program
 - Section 401 Water Quality Certification
- ◆ 23 CFR Part 650 Subpart A
- ◆ 23 CFR Part 650 Subparts C and H
- ◆ Memoranda of Understanding

It is possible to comply with the Federal requirements regarding the encroachment of a highway on a floodplain and still risk future legal liabilities because of the impact of the highway on the floodplain and the stream. Hydraulic engineers should review these potential liabilities and ensure that their evaluation is considered in design of highway projects.

National Flood Insurance Program

The National Flood Insurance Program (NFIP) was established under the [National Flood Insurance Act](#) (NFIA) in 1968 to reduce future flood losses through local floodplain management. NFIP requires participating cities, counties, or states, to adopt floodplain management ordinances containing certain minimum requirements intended to reduce future flood losses.

Special Flood Hazard Areas (SFHAs) are depicted on Flood Insurance Rate Maps (FIRMs) or Flood Hazard Boundary Maps (FHBMs) that have been prepared by [Federal Emergency Management Agency](#) (FEMA) for each participating community. The participating community is responsible for informing FEMA of any alterations or changes to the floodplain. TxDOT requires that designers inform the participating community through its [Floodplain Administrator](#) (FPA) of any changes to the floodplain or its parts via [FPA notification](#).

The following list identifies some typical conditions that must be checked for consistency with the requirements:

- ◆ Replacement of existing bridge with smaller opening area, e.g., shorter length, deeper deck, higher or less hydraulically efficient railing.
- ◆ Replacement of bridge and approach roadway with an increase in the roadway profile.
- ◆ Safety project involving addition of safety barrier.
- ◆ Rehabilitation or maintenance of roadway resulting in a higher profile.
- ◆ Highway crossing at a new location.
- ◆ Longitudinal encroachment of highway on floodplain (with or without crossing).

For more information on the NFIP, see Chapter 5 of this manual.

Executive Order 11988

[Executive Order 11988](#), May 24, 1977, requires each federal agency, in carrying out its activities, to take action (1) to reduce the risk of flood loss, to minimize the impact of floods on human safety, health and welfare, and to restore and preserve the natural and beneficial values served by floodplains; (2) to evaluate the potential effects of any actions it may take in a floodplain, to ensure its planning programs reflect consideration of flood hazards and floodplain management; and (3) to submit a report to the [Council of Environmental Quality](#) (CEQ) and the National Water Resources Council (WRC) on the status of procedures and the impact of the Order on the agency's operations. This executive order applies mostly to state buildings in the floodplain, but also requires TxDOT to consider alternatives that will not impact the floodplain. [U.S. Department of Transportation](#) Order 5650.2 contains DOT policies and procedures for implementing E.O. 11988.

National Environmental Policy Act

The National Environmental Policy Act (NEPA) was passed in 1969, [42 United States Code \(USC\) 4321-4347](#), to establish a national policy to protect the environment.

For more information on NEPA, see the TxDOT [Environmental](#) Manual.

Rivers and Harbors Act

The [U.S. Army Corps of Engineers](#) (USACE) began regulating activities in navigable waters with the Rivers and Harbors Act of 1899.

For more information on the Rivers and Harbors Act, see the TxDOT [Environmental](#) Manual and the TxDOT [Bridge Project Development](#) Manual.

Clean Water Act

The Clean Water Act (CWA) of 1972, [33 USC 1251-1387](#), was enacted to maintain and restore the chemical, physical, and biological integrity of the waters of the U.S. The broader jurisdiction under this law includes not only navigable waters, but also most waters of the country and adjacent wetlands. Provisions of the CWA are enforced by the [Texas Commission on Environmental Quality](#) (TCEQ) and the [USACE](#).

A water discharge permit or coordination is required whenever a project directly or indirectly impacts water resources. For more information on the CWA, see the TxDOT [Environmental Manual](#).

- ◆ **Section 402 National Pollutant Discharge Elimination System** In 1990, the EPA published [40 CFR Part 122](#), which contains regulations for the [National Pollutant Discharge Elimination System](#) (NPDES) storm water discharge permits. The purpose of this legislation is to improve the quality of the nation's rivers, lakes, and streams. NPDES regulations are administered by [Environmental Protection Agency](#) (EPA) and [TCEQ](#) through the [Texas Pollutant Discharge Elimination System](#) (TPDES) and the [Construction General Permit](#) (CGP).

The CWA makes it unlawful to discharge storm water from most construction sites in Texas, unless authorized by the TPDES CGP. Unlike an individual permit that authorizes discharge activities for a specific location, the general permits are for a specific activity (i.e. construction). The operator seeking authorization to discharge storm water is required to comply with the terms of the permit.

For more information on the CGP, see the TxDOT [Environmental Manual](#).

- ◆ **Section 404 Regulatory Program** [Section 404 of the Clean Water Act](#) (CWA) establishes a program to regulate the discharge of dredged and fill material into waters of the U.S., including wetlands. Section 404 makes it unlawful to discharge dredged or fill material into waters of the U.S. without first receiving authorization from the USACE. Activities that typically require authorization include placement of culvert pipes, bridge piers, riprap, or any other alteration to the stream including relocation.

The Section 404 Program can issue the following permits:

- nationwide permits
- individual 404 permit
- general permit

Some types of permits do not require individual review and approval by the USACE, while others may take several years to process and require extensive mitigation for impacts to Waters of the U.S. The type of permit that will be required depends on the degree of impact. Projects that impact less than 0.10 acre below the ordinary high water mark of the water body, and do not impact any wetlands, can often be authorized without individual review by the USACE.

For more information on the Section 404 Regulatory Program, see the TxDOT [Environmental Manual](#).

- ◆ **Section 401 Water Quality Certification** The issuance of any of the above permits is contingent on receipt of a water quality certificate or waiver of certification from the State in which the work is to be done. This certification assures that the proposed project will not violate effluent limitations and water quality standards established pursuant to Section 401 of the CWA, [33 USC 1341](#), as amended. Under Section 401, [TCEQ](#) is authorized to certify that federally issued permits will meet the state's water quality standards. TCEQ regulates this section under the [USACE](#) permit program and requires the installation of temporary and permanent storm water best management practice devices (BMPs) that have been approved by TCEQ. Environmental documents should include a general description of the measures that will be taken to minimize the potential for impacts to receiving waters under Section 404 and a discussion regarding compliance with Section 401 of the Clean Water Act.

For more information on Section 401 Water Quality Certification, see the TxDOT [Environmental Manual](#).

23 Code of Federal Regulations 650 Subpart A

When a TxDOT project with participation by the [FHWA](#) involves an encroachment on the 1% Annual Exceedance Probability (AEP) (100-yr event) floodplain, the location and design of the project must comply with FHWA Policy [23 CFR 650, Subpart A](#). Compliance with this regulation is required when a proposed project includes a new or expanded encroachment on a floodplain regulated by [FEMA](#), or contains the potential for adversely impacting private property or insurable buildings on or near a floodplain.

The FHWA has prepared a non-regulatory supplement, [23 CFR 650, Subpart A, Attachment 2](#), which explains the requirements for coordination with FEMA and the local community responsible for administering the NFIP under different floodplain encroachment scenarios. [Chapter 5](#) of this manual explains TxDOT procedures for compliance with these requirements.

23 Code of Federal Regulations 650 Subparts C and H

The January 2005 updated regulation, [23 CFR 650, Subpart C](#), underscores FHWA guidance regarding [Plans of Action](#) (POA) for scour critical bridges. TxDOT scour issues and countermeasure designs are handled by the Bridge Division, Geotechnical Section. Refer to the TxDOT [Geotechnical Manual](#) for more information. The regulation [23 CFR 650, Subpart H](#) requires coordination with the [United States Coast Guard](#) (USCG) and USACE in providing adequate vertical and horizontal clearance for navigation on navigable waterways and is covered in the TxDOT [Bridge Project Development Manual](#).

Memoranda of Understanding (Federal)

Some projects may be governed or affected by a Memorandum of Understanding (MOU). An MOU is an executed understanding between TxDOT and other state or federal agencies. The purpose of an MOU is to guide both parties concerning their roles and responsibilities necessary to achieve effective coordination of project activities. MOUs are used to expedite the review process and minimize the required documentation for such items as:

- ◆ Funding
- ◆ Design criteria
- ◆ Construction
- ◆ Maintenance.

TxDOT has not negotiated MOUs for hydraulic design with any federal agencies.

Section 3 — State Statutes and Rules Governing Hydraulic Design

As with Federal laws, TxDOT must comply with State regulations and statutes. This chapter explains some of the relevant state regulations. It is not an exhaustive discussion of state regulations that could affect TxDOT hydraulic design.

The following subsections discuss:

- ◆ Texas Water Code Chapter 11
- ◆ Texas Water Code Chapter 16 Subchapter I
- ◆ Title 30 Texas Administrative Code Chapter 299
- ◆ Title 43 Texas Administrative Code Rule 15.54(e)
- ◆ Memoranda of Understanding, State
- ◆ Texas Executive Order D.B. No. 34

Texas Water Code Chapter 11

Section 11.021

The [Texas Water Code Section 11.021](#) states that the water of the ordinary flow, underflow, and tides of every flowing river, natural stream, and lake, and of every bay or arm of the Gulf of Mexico, and the storm water, floodwater, and rainwater of every river, natural stream, canyon, ravine, depression, and watershed in the state is the property of the state. Water imported from any source outside the boundaries of the state for use in the state and which is transported through the beds and banks of any navigable stream within the state or by utilizing any facilities owned or operated by the state is the property of the state.

Section 11.086

The [Texas Water Code Sections 11.086](#) states that no person may divert or impound the natural flow of surface waters in Texas, or permit a diversion or impoundment to continue, in a manner that damages the property of another by the overflow of the water diverted or impounded. A person whose property is injured by an overflow of water caused by an unlawful diversion or impoundment has remedies at law and in equity and may recover damages occasioned by the overflow.

Texas Water Code Chapter 16 Subchapter I

[Texas Water Code Chapter 16, Subchapter I](#) establishes the positive interest of the State of Texas in the [NFIP](#). TxDOT is an entity of the state and is prohibited from obtaining permits from subordinate jurisdictions. Also, the State of Texas (and therefore TxDOT) is not a participating community

in the NFIP. TxDOT will, however, work with communities to prevent flood damage and minimize impacts, as obligated by this statute. See [Chapter 5](#) for more information.

Title 30 Texas Administrative Code Chapter 299

Regulation of the [Texas Dam Safety Program](#) was established by the [TCEQ](#) and is contained in [30 TAC Chapter 299](#), which provides for the safe construction, maintenance, repair and removal of dams in Texas.

Title 43 Texas Administrative Code Rule 15.54(e)

This section of the [TAC](#) describes the conditions under which state, federal and local financing of drainage construction costs are to be shared. In general TxDOT's responsibility includes:

- ◆ Constructing drainage systems, including outfalls, within the state right of way
- ◆ Adjusting or relocating existing drainage channels when necessary
- ◆ Adjusting structures and channels to accommodate any approved drainage plan.

Although TxDOT can adjust a facility to accommodate public improvement works that directly benefit the operation of the highway, it is not required to make changes to highway facilities just to accommodate development in the drainage area.

Parties wishing to discharge drainage onto or across the state highway right of way, where there is no existing drainage system, must obtain approval from TxDOT and provide design, construction, and maintenance costs. Local governments wanting to connect to a TxDOT drainage system must first have approval from TxDOT, and then must bear the cost of collecting and carrying its water to the TxDOT system as well as contribute a share of the TxDOT system costs.

Memoranda of Understanding (State)

The [Texas Transportation Code, 201.607](#) requires TxDOT to adopt a MOU with each state agency that has responsibility for protection of the natural environment or for preservation of historical or archeological resources. Environmental documents that meet MOU criteria are sent to these agencies for review and comment.

One MOU significant to TxDOT Hydraulic Design is the agreement between TxDOT and the Texas Natural Resources Conservation Commission (TNRCC), now the TCEQ, which acknowledges that TxDOT is complying with minimum NFIP regulations in the work that it conducts in flood hazard areas.

Texas Executive Order D.B. No. 34

This 1977 Executive Order, [Evaluation of Flood Hazard in Locating State Owned or Financed Buildings, Roads, and Other Facilities](#), was signed to bring the State of Texas into compliance with Presidential Executive Order 11988.

Section 4 — Policies, Standard Practices, Requirements, and Guidance

This manual identifies those policies, standard practices, criteria, guidance and references approved for use in carrying out the hydraulic design responsibilities in TxDOT. In this regard, the following definitions will be used:

- ◆ A **policy** is a statement of position, reflecting the preferred philosophy of the agency. Policy comprises a set of self-imposed boundaries on decisions in the course of business under ordinary or anticipated conditions.
- ◆ A **standard** is a fixed reference to guide the outcome and content (product) of the work. Standards are established where there is a consistent level of risk or there is a consistent technical or performance expectation for a specific product to work well in most cases. In this manual standards frequently refer to the expected design Annual Exceedance Probability (AEP) for a particular type of drainage structure on a particular class of highway. (See [Chapter 4](#) for an explanation of AEP). Variances to TxDOT standards are not uncommon, but they need always be justified in writing. Attention to variances and guidance on how to request and justify them are included in this manual. Exceptions and waivers to the standards are handled in each section as applicable.
- ◆ **Criteria** are tests or indicators, in addition to standards, used to measure/judge achievement of applicable policy or standard objectives. Criteria may vary from project to project. An example of a criterion in this manual is the constraint on headwater depth at a culvert.
- ◆ TxDOT **standard practices** are methods and procedures that have a history of use within the department for addressing situations characteristic and commonly encountered. The only justification needed for the use of standard practices is evidence that they are appropriate for the situation at hand. Deviation from standard practices may be required in any situation where evidence that standard practices are applicable cannot be readily demonstrated.
- ◆ **Guidance** refers to recommended, but not necessarily required, actions to meet policies and standards, and expectations for applying discretion.
- ◆ **Discretion** in this context refers to engineering judgment applied by the practitioner to an appropriate technique or solution that is within an acceptable range of values.

In this manual, considerations for identifying appropriate standards, design criteria, and standard practices are included at the beginning of each chapter. Guidance is provided where appropriate to assist the user in formulating an approach to meet the standards and criteria.

Ignoring the appropriate standards and design criteria may result in a project delayed from the scheduled letting. If an exception is needed to a standard or design criterion, the TxDOT [Project Development Process](#) Manual (PDP) should be consulted for directions on applying for exceptions and waivers. [Design Division Hydraulics Branch](#) (DES-HYD) should be consulted as early as possible to work out an acceptable alternative.

Section 5 — Roles and Responsibilities for Hydraulic Analysis and Design

This section presents information on the roles and responsibilities of design engineers, managers and consultants in the hydraulic analysis and design process of TxDOT projects.

Area/ Design Office Engineers

Design Engineers. The responsibilities of the Design Engineers as they relate to hydraulic analysis and design include the following:

- ◆ Develop and maintain proficiency and competency in all aspects of hydrologic and hydraulic analysis and design. Educate, train and develop junior engineers and designers.
- ◆ Prepare and oversee preparation of drainage analyses and designs including hydrology, open channel hydraulics, bridge hydraulics, culvert hydraulics, storm drains, and pump stations.
- ◆ Ensure appropriate coordination and communication between drainage design functions and all other project design functions, including roadway, geotechnical, bridge, and signage.
- ◆ Ensure compliance with applicable laws, regulations, policies, and District/Area Office preferences.
- ◆ Provide and maintain documentation of all drainage analyses and designs in accordance with District/Area Office preferences and this manual.
- ◆ Develop and maintain systematic documentation files of facility experiences either at the district or at the local level
- ◆ Provide quality control techniques for work performed by subordinates and perform quality assurance on the work.
- ◆ Promptly report drainage complaints to the District Hydraulics Engineer (DHE).
- ◆ Promptly notify the DHE of any significant runoff and flood events and collect appropriate data (photographs, survey data, etc) for documentation.

Consultant Engineers. The responsibilities of Consultant Engineers as they relate to hydraulic analysis and design of TxDOT projects include the following:

- ◆ Develop and maintain proficiency and competency in all aspects of hydrologic and hydraulic analysis and design. Educate, train and develop junior engineers and designers.
- ◆ Prepare and oversee preparation of drainage analyses and designs, including hydrology, open channel hydraulics, bridge hydraulics, culvert hydraulics, storm drains, and pump stations.
- ◆ Ensure compliance with applicable laws, regulations, policies, and District/Area Office preferences.

- ◆ Provide and maintain documentation of all drainage analyses and designs in accordance with District/Area Office preferences and this manual.
- ◆ Provide quality control for work performed by subordinates.
- ◆ Comply with contract scope and requirements.

TxDOT Contract Managers

- ◆ Oversee consultant work authorizations in accordance with Design Division – Consultant Contract Office (DES-CCO) “[Roles and Responsibilities](#)” table.
- ◆ Review consultant work to ensure compliance with contract scope, applicable laws, regulations, policies, District/Area Office preferences, and adherence to TxDOT comments and directives.

TxDOT Project Managers

- ◆ Direct and coordinate preparation of drainage analyses and designs, including hydrology, open channel hydraulics, bridge hydraulics, culvert hydraulics, storm drains, and pump stations.
- ◆ Verify compliance with applicable laws, regulations, policies, and District/Area Office preferences.
- ◆ Ensure and oversee documentation of all drainage analyses and designs in accordance with District/Area Office preferences.
- ◆ Provide quality assurance for work performed by subordinates.
- ◆ Promptly report drainage complaints to the District Hydraulics Engineer (DHE).
- ◆ Promptly notify the DHE of any significant rainfall/runoff and flood events and collect appropriate data (photographs, survey data, etc) for documentation.
- ◆ Oversee consultant work authorizations in accordance with DES-CCO “Roles and Responsibilities” table.
- ◆ Review consultant work (Work Authorizations) to ensure compliance with contract scope, applicable laws, regulations, policies, District/Area Office preferences, and adherence to TxDOT comments and directives.
- ◆ Coordinate with the DHE to identify training needs and pursue training opportunities.

District Hydraulics Engineers

- ◆ Develop and maintain proficiency and competency in all aspects of hydrologic and hydraulic analysis and design. Educate, train and develop junior engineers and designers.
- ◆ Serve as point of contact for [DES-HYD](#) for dissemination of statewide policy, guidance, research, training, software and other related hydraulics and hydrologic issues or needs

- ◆ Serve as point of contact for district and area office staff for fundamental expertise on hydraulics and hydrology including consistent application of statewide and district design policy
- ◆ Serve as the liaison with the DES-HYD on complex hydraulics design and hydraulics-related design or policy issues
- ◆ Provide design support and approval for hydraulic and hydrologic methods for use by district, area office, and consultant designers
- ◆ Oversee and approve or perform routine hydraulic and hydrologic studies, designs, and analyses for district projects and consultant contracts
- ◆ Prepare, review, and comment on or approve hydrologic/hydraulic reports.
- ◆ Provide hydraulic, hydrologic and related regulatory review of projects prior to preliminary layout or Plans, Specifications, and Estimates (PS&E) submission for letting
- ◆ Provide mentoring to other district personnel in hydraulics and hydrology and for district staff in hydraulic and hydrology rotation
- ◆ Support the district environmental quality coordinator and/or environmental coordinator on hydraulics for environmental and water quality issues
- ◆ Investigate and help resolve drainage related issues with the public
- ◆ Support district maintenance staff with performance and maintenance of drainage structures, including data collection on chronic problem areas or extreme events
- ◆ Recommend research and volunteer as research project directors and advisors as approved by the district engineer
- ◆ Coordinate with local governments, developers, and property owners concerning hydraulics-related issues, including the monitoring of local studies and activities that may impact TxDOT drainage facilities or operations
- ◆ Coordinate with TxDOT project managers, DES-HYD staff, and District Human Resources staff to provide hydrologic and hydraulic training for TxDOT employees.

Design Division Hydraulics Branch (DES-HYD)

- ◆ Hydraulic Report review - DES-HYD is tasked to review and comment on hydraulic reports with regard to applicability, methodology, detail, documentation, accuracy, and composition. The sealing engineer (District or Consultant) is expected to address all comments and return the report in a timely manner.
- ◆ Preliminary review – DES-HYD is tasked to review preliminary designs. Typical designs reviewed include bridges and bridge class culverts. DES-HYD review covers methodology, detail, documentation, and accuracy to TxDOT standards. Preliminary submittals are preferred because they are early enough in the process that design corrections usually can be implemented.

- ◆ PS&E review – DES-HYD is tasked to review plans submitted for letting with regard to methodology, detail, documentation, and accuracy to TxDOT standards. The District or its Consultant is expected to make all reasonable changes to the plans prior to letting.
- ◆ Expert Guidance – DES-HYD is tasked to provide guidance, help, or advice on any hydrology and hydraulics subject as needed and called upon by the District or Area Offices.

Section 6 — Local Agency Ordinances and Requirements

Local agencies may be involved in numerous phases in TxDOT projects for various reasons. For instance, coordination with local agencies may be needed in order to ensure a project complements the surrounding community, or when facilities not owned or maintained by TxDOT are to be constructed, modified or affected by a TxDOT project. Local agencies may be required to participate in project development by providing funding.

TxDOT is not generally obligated to design or meet local agency requirements that may differ from or be more stringent than state or federal requirements. Certain situations may lead to TxDOT's acceptance of local requirements. For example, the Record of Decision (ROD) associated with an Environmental Impact Statement or Environmental Assessment may require adherence to certain local requirements as a condition of project approval. Another example may be a case in which the local agency is to assume ownership and maintenance of a drainage facility once the construction by TxDOT is complete. Any costs beyond what TxDOT deems necessary and proper associated with meeting local requirements will be the full responsibility of the local agency.

At the discretion of the District Engineer or other designated District personnel, TxDOT may choose to accommodate criteria different or more restrictive than those customary for TxDOT. Each District has reasonable latitude to act in the spirit of cooperation with other agencies, when to do so is deemed by District staff to be in the best interest of the public. Such accommodation should be on a case-by-case basis; prior accommodation should not be viewed as assurance of future accommodation.

Section 7 — Responding to Drainage Complaints

Drainage complaints should be dealt with promptly and in an unbiased manner. The following steps are presented to help TxDOT to obtain a thorough understanding of the basis of an individual complaint and assure the appropriate action is taken.

1. Office receiving the complaint must acknowledge the complaint within one day if possible. Individuals do not register complaints with only a casual interest in their outcome. Timely acknowledgement is indispensable.
2. Office receiving the complaint must notify or forward the complaint to the District Hydraulics Engineer within 1 day of receipt.
3. The DHE or District must notify DES-HYD of the complaint.
4. District must notify [Office of General Counsel](#) (OGC) if litigation is filed or threatened.
5. District must investigate the facts. Clearly determine the basis for the complaint, including the extent of flooding, complainant's opinion of what caused the flooding, description of alleged damages, and dates, times, and duration of flooding. Relate the history of other grievances at the site. DES-HYD should be called for technical assistance if necessary.
 - a. Visit the site as soon as possible after receiving complaint
 - b. Talk to the complainants
 - c. Take photographs
 - d. Take measurements
 - e. Prepare notes from the site visit and investigation
 - f. Locate and obtain as-built plans from latest and all applicable projects
 - g. Obtain accurate GIS files if available
 - h. Locate and obtain applicable hydrology and hydraulics reports
6. District must determine an appropriate course of action. Analyze the facts and decide what action to take to relieve the problem, regardless of who has responsibility for the remedy. Make conclusions and recommendations, describe the contributing factors leading to the alleged flood damage, and specify feasible remedies. Keep DES-HYD informed of the progress and developments.
7. District must prepare and file documentation. Ensure a file documenting the complaint, response and resolution is maintained.

Section 8 — Developments Connecting into TxDOT Hydraulic Structures

Drainage related issues are covered in the [43 TAC, Part 1, Chapter 15, Subchapter E](#). See [Section 3](#) for more details.

TxDOT does not allow private or municipal connection to TxDOT storm drainage facilities without approval. Requests are submitted to the DHE and must be supported by full hydrologic and hydraulic analyses comparing existing and proposed conditions.

When a request is received by TxDOT, the DHE or DHE's representative will verify the applicant's existing conditions runoff computations and consider available increased flow, if any, for which the facility was designed. The DHE will use this information to determine how much if any additional flow may be received, at what design [Annual Exceedance Probability](#) (AEP), and whether by overland flow or direct connection. Once an acceptable design AEP flow rate is determined, the requestor is required to prepare plan sheets conforming to the TxDOT requirements and containing the required detail. TxDOT will review the engineering drawings for completeness and compliance, and approves the request after comments are addressed.

Section 9 — Dams

Under [30 TAC Chapter 299](#) a dam is defined as any barrier, including one for flood detention, designed to impound liquid volumes and which has a height of dam greater than six feet. This does not include highway, railroad, or other roadway embankments, including low water crossings that may temporarily detain floodwater, levees designed to prevent inundation by floodwater, closed dikes designed to temporarily impound liquids in the event of emergencies, or off-channel impoundments authorized by the [TCEQ](#) under [Texas Water Code Chapter 26](#).

[Dam Safety](#) rules do not apply to roadway embankments, even though they may temporarily impound water, unless the embankment was also intended to function as a detention dam. TxDOT practice is to avoid using a highway embankment as a detention dam unless the embankment has been specifically designed to TCEQ dam specifications. TxDOT practice is to comply with [30 TAC Chapter 299](#) and avoid building roads on or near dams. Any questions regarding a roadway on or near a dam should be directed to the DHE or DES-HYD.

Chapter 3 — Processes and Procedures in TxDOT Hydrologic and Hydraulic Activities

Contents:

[Section 1 — Overview](#)

[Section 2 — Scope of Hydrologic and Hydraulic Activities](#)

[Section 3 — Evaluation of Risk](#)

[Section 4 — Design Activities by Project Phase](#)

[Section 5 — Documentation and Deliverables](#)

Section 1 — Overview

The nature and scope of hydraulic analysis and design work varies depending on the type of project being undertaken and on the hydrologic/hydraulic (H&H) setting of the project. Projects that consist of repair or minor alteration without change to the roadway profile may only require cursory examination for hydraulic effects. An overlay project may or may not require a full H&H analysis, depending on surrounding factors. A project with a bridge or culvert replacement may require different H&H inputs than a culvert extension or a bridge modification. All of the above project types differ from an urban street project with curb, gutter and storm drain. This chapter provides a general discussion on establishing the appropriate scope of hydraulic activities for the overall project and for various phases within a project. It also describes the required deliverables for a variety of project types.

Section 2 — Scope of Hydrologic and Hydraulic Activities

Scoping and reconnaissance are the investigative processes aimed at determining which issues are to be addressed by the project. Scoping initially identifies the major needs, issues, constraints, and feasibility of proposed improvements from which the more comprehensive, interdisciplinary preliminary engineering activities, surveys, investigations, environmental studies, and analysis can be effectively planned and budgeted. This includes the major elements of hydrologic and hydraulic work necessary to develop the project.

Reconnaissance is the collection of information that would generally be sought, collected, and used, as standard practices for the design whenever available and applicable. The following list includes broad categories for the H&H portion of the work:

- ◆ Previous hydrology/hydraulic studies and reports
- ◆ Hydrological data (rainfall, gage data, flood history, etc.)
- ◆ Site visit and reconnaissance
- ◆ Aerial/site photography
- ◆ Survey and mapping
- ◆ Land use, ground cover, soils information
- ◆ Fluvial geomorphic data (plan forms, bed and bank sediment characteristics, etc.)
- ◆ As-built plans
- ◆ Bridge inspection reports
- ◆ Maintenance reports

The nature and extent of work proposed for drainage structures will affect the level of H&H analysis and the applicability of the standards and criteria presented in this manual. The scoping and reconnaissance effort should always include an appropriate assessment of the existing physical condition and the hydraulic performance of all drainage structures. A site visit is usually required for proper reconnaissance. The findings of the assessment will lead to recommendations as to whether existing structures should be replaced, rehabilitated, modified, abandoned, or left undisturbed.

Hydraulic Considerations for Rehabilitated Structures

This chapter defines rehabilitated structures as existing structures that are not to be replaced, but may be substantially repaired, modified, or extended as part of the project. Common examples of rehabilitated structures include, but are not limited to:

- ◆ A culvert that is to be extended to accommodate roadway widening
- ◆ A culvert needing repair due to heavy corrosion

- ◆ A bridge deck to be reconstructed or widened
- ◆ A cross drainage structure beneath a road that is to be reconstructed
- ◆ A structure being retrofitted for fish passage
- ◆ An existing storm drain receiving additional or improved curb inlets
- ◆ A storm drain outfall requiring mitigation of scour problems

If a structure is to be rehabilitated, the standards and criteria presented in this manual may not be feasible, applicable or appropriate because of constraints imposed by project budget, right-of-way, or schedule. However, the impacts of a rehabilitation project, whether safety or maintenance projects, must be considered and evaluated. Such projects, for instance may cause changes to the flood surface profile, stream stability, or increase flood risk to neighboring properties. In determining whether a variance from standards and criteria is appropriate, an assessment of the risk involved should be undertaken, as discussed in the next section. The complete replacement of an existing structure that has exhibited no history of past problems must be justified by a compelling reason; simply that it does not meet current hydraulic criteria for new design is not sufficient.

Hydraulic Considerations for New Structures

The standards and criteria presented in this manual should be regarded as the minimum acceptable for projects involving new drainage structures or replacements of existing structures. Exceptions or variances may be justified by a risk assessment or detailed risk analysis. New and replacement structures should be, to the extent feasible, located, oriented, and sized so as to minimize the potential for hydraulic problems such as excessive scour or adverse impact on flood profiles.

Section 3 — Evaluation of Risk

As with other natural phenomena, occurrence of flooding appears to be governed by chance. The chance of flooding is described by statistical analysis of flooding history in the subject watershed or in similar watersheds. Because it is not economically feasible to design a structure for the maximum possible runoff from watershed, the designer must choose a design frequency, or inversely the Annual Exceedance Probability (AEP) of a flood appropriate for the structure. (See [Chapter 4](#) for an explanation of AEP). Once a design AEP is selected, the structure should be designed to provide adequate capacity to appropriately convey the discharge associated with that probability. In this process the designer sets the level of conservatism by the selection of the design AEP. This is in contrast to the conservatism associated with structural design elements, which is typically based on safety factors in loading and structural capacity.

The design AEP can be established by standards or limited by factors such as economic considerations. Numerous methods have been developed to assist the engineer in assessing the risk involved in choosing the design flood and the check flood. For the purposes of this manual, risk is defined as the consequences associated with the probability of flooding attributable to the project, including the potential for property loss and hazard to life during the service life of the highway. A project can be fully compliant with policy and standards yet still incur an inappropriate level of risk. Consequently, all sources of potential risk should be considered as part of the H&H investigation for hydraulic structures in order to determine whether modified site-specific standards or criteria are appropriate.

If the consideration of risks appears to warrant a design criteria more or less stringent than the standard, a risk assessment should be conducted. As described below, the assessment of risk can be either qualitative or quantitative in nature. If the results of the assessment show that lower standards are warranted, the assessment will be documented through the design exception process and coordinated with the District Hydraulics Engineer (DHE) and the Hydraulics Branch of the Design Division (DES-HYD).

Most projects will require only a qualitative risk assessment. A qualitative risk assessment may be determined appropriate or inappropriate based on such considerations as the presence or absence of structures that could be impacted by the project, the perceived economic impact of temporary road closures, the environmental impact, or the cost of the roadway facility itself.

Highly complex, expensive projects or those with particularly high levels of risk may justify detailed and quantitative risk analyses. A quantitative risk analysis provides a detailed economic comparison of design alternatives using expected total costs (construction costs and maintenance costs plus risk costs such as the economic cost of an extensive and long-duration detour in the event of a failure, the cost of repair, etc.) to determine the alternative with the least total expected cost to the public. A quantitative risk analysis supports the appropriate design discharge and criteria based

on the economic comparison of alternatives rather than a set of predetermined design AEPs and criteria such as those presented in this manual.

[HEC-17](#), FHWA 1981 is a publication that provides procedures for the design of encroachments on floodplains using risk analysis. HEC-17 describes a quantitative assessment method called Least Total Expected Cost (LTEC). Least total expected cost refers to the result of a detailed economic analysis that attempts to account for all viable costs associated with a project. The analysis is ideally based on actual cost data.

Risk Assessment Forms

The TxDOT form titled “[Economic and Risk Assessment for Bridge Class Structures](#)” is a helpful resource in developing a qualitative risk assessment. The form has an associated [worksheet](#) to assist in developing a simplified estimation of the annual risk cost and annual capital cost. The form provides guidance on when a more detailed analysis following the HEC-17 LTEC approach is justified.

Section 4 — Design Activities by Project Phase

The following section describes the hydraulic design activities typically expected to occur in each phase of a project. The descriptions are largely derived from the TxDOT [Project Development Process Manual](#).

Planning and Programming

One of the objectives of the planning and programming phase is to develop a planning-level cost estimate. Certain projects involving significant drainage-related challenges may require some initial hydrologic and hydraulic investigation in order to appropriately estimate the nature and approximate size of required drainage structures for estimating purposes. The DHE should be consulted during the planning and programming phase to assess whether drainage issues will pose significant challenges to the project.

Preliminary Design

In the preliminary design phase, the DHE should expect to participate in the [Design Concept Conference](#) to provide general background information on hydrology and hydraulics, and to identify major drainage features and regulatory constraints.

Drainage-related agreements and contracts that TxDOT has with other agencies need to be identified and taken into consideration during the preliminary design phase. Identification of existing agreements also helps determine the possible need for additional agreements. Some agreements may need to be amended and the appropriate division can assist. The Right of Way (ROW) and DES are involved with coordination of existing drainage agreements and in determining the need for additional agreements.

The locations and sizes of proposed cross-drainage structures (bridges and culverts) must be determined early in the preliminary design phase because of their potential to affect the roadway profile and other elements of the preliminary design of the project. Preliminary hydraulics analyses for bridges will enable the determination of the bridge limits, span/girder type, span lengths, bent locations, and bent orientation. An important aspect of the hydraulic analysis at this stage is consideration of the [NFIP](#) and whether the project will cross an NFIP designated [Special Flood Hazard Area](#) (SFHA).

Since many of the design parameters for drainage structures are to be established during the preliminary design phase, it is necessary to conduct the bulk of the hydrologic and hydraulic analysis during this phase. These analyses will usually include, but may not be limited to:

- ◆ Field reconnaissance
- ◆ Collection of relevant data on the stream and watershed
- ◆ Gathering of relevant previous hydrologic studies by TxDOT and other entities
- ◆ Conducting required hydraulic surveys of existing structures and streams
- ◆ Obtaining available topographic mapping of the streams and floodplains
- ◆ Establishing the relationship between flood discharge and AEP through hydrologic analysis or by adopting previous hydrologic analyses
- ◆ Determining stream flood profiles for existing conditions through hydraulic modeling
- ◆ Determining required sizes of drainage structures to meet design criteria
 - For bridges this includes establishing preliminary opening size, span lengths, pier locations and girder elevation
 - For culverts preliminary design of opening size and profile is performed
 - For storm drains this includes preliminary design of trunk alignment, size and profile
- ◆ Estimating stream flood profiles under proposed project conditions (potentially for multiple design alternatives) to determine project impacts
- ◆ Adjusting proposed structure designs as necessary to mitigate project impacts

All projects affecting a waterway used for navigation require coordination with the [USCG](#) and the [USACE](#). Hydraulic investigations or design may also be required for ensuring compliance with the USCG and USACE regulations.

See the TxDOT Project Development Process Manual, [Chapter 2](#) for further discussion of the preliminary design phase.

Environmental

Preliminary hydraulic studies are needed in the preparation of environmental documentation to evaluate the impacts of the proposed project on waterways and floodplains. Changes in water surface elevation, construction in channels, bridge construction methods, etc. commonly impact water resources. The identification of appropriate temporary and permanent stormwater quality best management practices may require input from the DHE and the District Environmental Quality Coordinator during the environmental documentation phase.

See the TxDOT Project Development Process Manual, [Chapter 3](#) for further discussion of the environmental permitting and documentation phase.

PS&E Development

The Design Concept Conference marks the beginning of Plans, Specifications, and Estimates (PS&E) preparation and occurs after most of the background data is gathered and the preliminary hydrologic/hydraulic analysis and design is complete.

As part of the detailed design process, stream crossing hydrology and hydraulics should be refined and finalized. Refinement is usually needed to reflect detailed field survey data, changes in basic design conditions or assumptions, or to reflect revised methodology if there has been a significant delay between schematic development and PS&E development.

The [FHWA](#) requires a bridge scour evaluation during the hydraulic design process for all bridges. The results of a scour evaluation may highlight the need for design adjustments such as increasing the opening size, deepening the foundations, adding pier or abutment protection, or incorporating other mitigation measures. Scour countermeasure design is to be performed or directed and approved by the [Geotechnical Section](#) of the Bridge Division (BRG).

In addition to bridge hydraulic design and scour evaluations, a number of other H&H tasks are required as a project design is being finalized. These tasks include, but are not limited to:

- ◆ Refining the hydraulic design of culverts to finalize sizes, invert profile, end treatment and outlet protection;
- ◆ Preparing final storm drain details including design of appropriate sized inlets at the proper spacing and lateral sizing;
- ◆ Preparing pump station details for projects involving pump facility construction: and
- ◆ Preparing or contributing to the development of [Stormwater Pollution Prevention Plans](#) (SW3Ps) after the roadway drainage design is completed

Finalized hydraulic calculation sheets and hydraulic reports should be reviewed by the district and then submitted to DES-HYD for review and approval before PS&E submittal.

See the TxDOT Project Development Process Manual, for further discussion of the [PS&E development phase](#).

Section 5 — Documentation and Deliverables

This section provides a general summary of the required documentation for hydraulic analysis and design. The specific documentation requirements for particular types of drainage structures are explained in the chapters dealing with those structures.

Key Elements of Hydraulic Documentation

The type and nature of documentation and deliverables required varies depending upon the project or effort being undertaken. Whatever the context may be and whatever format of documentation may be used, certain key elements should typically be documented:

- ◆ Parameter and criteria considerations -- Documentation of parameter and criteria considerations includes data source identification, evaluation of data, assessments of the reliability of data, what decisions were made and why, qualifying statements such as limitations and disclaimers, and design values comprising the set of parameters and criteria that govern the design. Design parameters define the limits of the facility design. For example, in sizing a structure, design parameters include economically available shapes, environmentally suitable materials, and physical geometric limitations. Examples of criteria include allowable headwater (for a culvert), allowable through-bridge velocity (for a bridge), and maximum allowable water discharge rate from a pump station. Both design parameters and criteria are established from the unique characteristics of the design site and situation. The parameter and criteria considerations should be fully documented for the design of TxDOT drainage facilities.
- ◆ Federal and state regulatory criteria (see [Chapter 2](#)).
- ◆ TxDOT procedures and practices (see [Chapter 2](#)).
- ◆ Past performance of existing facilities at the subject location. Such experience may include operation during flood events, erosion activity, structural response to flood events, failures, maintenance required (and for what reason), and description and cost of maintenance. District offices should develop and maintain systematic documentation files of facility experiences either at the district or at the local level.
- ◆ Judgments, assumptions and decisions incorporated in the decision process or design.
- ◆ Plan, profile and detail drawings explaining the design.
- ◆ Special Provisions, Special Specifications, or General Notes governing material and construction requirements for any element of the drainage design not addressed by standard specifications.

Special Documentation Requirements for Projects crossing NFIP designated SFHA

A detailed report is required for any bridge replacement or rehabilitation project, or any roadway reconstruction project impacting [NFIP](#) floodplains mapped as Zone A (approximate) or Zone AE (detailed study with base flood elevations determined). The TxDOT document “[Recommended Format for Drainage Reports](#),” describes the expected content of a report in this context. The report typically consists of an introduction, a hydrology description, description of hydraulic analysis and a summary of conclusions and recommendations.

The introduction describes the purpose of the project, the specific impacts on the stream crossing, and the purpose of the study. The hydrology section describes the watershed, including climate, soils, and other pertinent data, and identifies the methodology used to compute flow. The hydraulics section includes analysis of the existing structure or conditions and design alternatives as well as an overview of the hydraulic modeling process. The hydraulics section also discusses design alternatives and provides a preferred alternative.

Permanent Retention of Documentation

Hydraulic reports and H&H calculations should be retained in the District/Area Office project file for permanent reference. The need for such records may not arise until years after the project has been completed. Retaining these records will provide many benefits, including:

- ◆ Ease of reference for future alteration or rehabilitation of the subject drainage structure
- ◆ Justification of design decisions in case of future challenges or litigation
- ◆ Valuable reference information for the design of other structures crossing the same stream or in the same watershed
- ◆ Proof of intended compliance with regulations such as [NFIP rules](#)

Documentation Reference Tables

The following tables indicate the required documentation of various facility types for preliminary review, PS&E review, and field change requests. The tables also indicate whether the information should reside in construction plans. The construction plans constitute part of the permanent file, but not all project information resides in the construction plans.

The following table shows the data documentation requirements:

Table 3-1: Data Documentation Requirements

Documentation Item (by facility type)	Stage			Location of Information		
	Preliminary Review	PS&E Review	Field Changes	Construction Plans	Permanent File	Report
Data						
Field survey data	X	X	X		X	
Vertical Datum	X	X	X	X	X	X
Historical data	X	X	X	X	X	X
FEMA FIS summary data and maps (where applicable)	X	X	X		X	X
Soil maps	X	X	X		X	
Land use maps (when applicable)	X	X	X	X	X	
Stream gauge data (where applicable)	X	X	X		X	X

The following table shows the hydrology documentation requirements:

Table 3-2: Hydrology Documentation Requirements

Documentation Item (by facility type)	Stage			Location of Information		
	Preliminary Review	PS&E Review	Field Changes	Construction Plans	Permanent File	Report
Hydrology						
Drainage area map(s) showing boundaries, outfalls, flow paths, etc.	X	X	X	X	X	X
Relevant watershed parameters (e.g. areas, runoff coefficients, slopes, etc.)	X	X	X	X	X	X
Assumptions and limitations	X	X	X		X	X
Hydrologic method(s) used	X	X	X	X	X	X
Hydrologic calculations	X	X	X	X	X	X
Peak discharges for design and check floods	X	X	X	X	X	X
Runoff hydrographs for design and check floods (where applicable)	X	X	X	X	X	X

The following table shows the channel documentation requirements:

Table 3-3: Channel Documentation Requirements

Documentation Item (by facility type)	Stage			Location of Information		
	Preliminary Review	PS&E Review	Field Changes	Construction Plans	Permanent File	Report
Channels						
See Hydrology for runoff determination	X	X	X	X	X	X
Channel cross sections and thalweg profile	X	X	X	X	X	X
Plan showing location of sections	X	X	X		X	X
Cross section subdivisions and "n"-values	X	X	X	X	X	X
Assumptions and limitations	X	X	X		X	X
Hydraulic method or program used	X	X	X	X	X	X
Water surface elevations and average velocities for design and check floods	X	X	X	X	X	X
Analysis of existing channel for comparison (if improvements proposed)	X	X	X	X	X	X

The following table shows the culvert documentation requirements:

Table 3-4: Culvert Documentation Requirements

Documentation Item (by facility type)	Stage			Location of Information		
	Preliminary Review	PS&E Review	Field Changes	Construction Plans	Permanent File	Report
Culverts						
See Hydrology for discharge data	X	X	X	X	X	X
See Channels for tailwater data	X	X	X	X	X	X
Design criteria (Allowable headwater, outlet velocities, FEMA etc.)	X	X	X	X	X	X
Culvert hydraulic computations	X	X	X	X	X	X
Unconstricted and through-culvert velocities for design and check floods	X	X	X	X	X	X
Calculated headwater for design and check floods	X	X	X	X	X	X
Estimated distance upstream of backwater effect	X	X	X	X	X	X
Magnitude and frequency of overtopping flood	X	X	X	X	X	X

The following table shows the bridge documentation requirements:

Table 3-5: Bridge Documentation Requirements

Documentation Item (by facility type)	Stage			Location of Information		
	Preliminary Review	PS&E Review	Field Changes	Construction Plans	Permanent File	Report
Bridges						
See Hydrology for discharge data	X	X	X	X	X	X
See Channels for highwater data	X	X	X	X	X	X
Design criteria/parameters/assumptions (velocities, backwater, FEMA, etc.)	X	X	X	X	X	X
Plan showing location of HEC-RAS cross sections	X	X	X	X	X	X
Bridge hydraulic computations (cross-section output)	X	X	X			X
Unconstricted and through-bridge velocities for design and check floods	X	X	X	X	X	X
Calculated maximum backwater for design and check floods	X	X	X	X	X	X
Estimated distance upstream of backwater effect	X	X	X	X	X	X
Magnitude and frequency of overtopping flood	X	X	X	X	X	X
Scour calculations*	X					*
Estimated scour envelope*	X	X	X	X	X	*
* Can be combined with the scour computations report required by Bridge Division, Geotechnical Section.						

The following table shows the pump station documentation requirements:

Table 3-6: Pump Station Documentation Requirements

Documentation Item (by facility type)	Stage			Location of Information		
	Preliminary Review	PS&E Review	Field Changes	Construction Plans	Permanent File	Report
Pump Stations						
See Hydrology for discharge data	X	X	X	X	X	X
See Channels for tailwater data	X	X	X	X	X	X
See Storm Drains for inlet and outlet conduit data	X	X	X	X	X	X
Stage/storage curve	X	X	X	X		X
Pump capacity and performance computations	X	X	X		X	X
Pump hydraulic performance curves	X	X	X	X		X
Design peak and attenuated peak discharges	X	X	X	X	X	X
Maximum allowable headwater elevation	X	X	X	X	X	X
Switch-on and cut-off elevations	X	X	X	X		X
Sump dimensions	X	X	X	X		
Head loss calculations and total dynamic head	X	X	X		X	X
Pump sizes	X	X	X	X		X
Pump station details		X	X	X		

The following table shows the storm drain documentation requirements:

Table 3-7: Storm Drain Documentation Requirements

Documentation Item (by facility type)	Stage			Location of Information		
	Preliminary Review	PS&E Review	Field Changes	Construction Plans	Permanent File	Report
Storm Drains						
See Hydrology for discharge data	X	X	X	X	X	
See Channels for tailwater data	X	X	X	X	X	
Storm drain schematic/layout showing trunklines, laterals, inlets, outfall etc.	X	X	X	X		
Storm drain hydraulic computations including all allowables	X	X	X	X	X	
Storm drain plan/profile sheets w/ hydraulic grade line		X	X	X	X	
Outfall considerations and information					X	
Flow direction arrows	X	X	X	X		
Evaluation of existing facility (if present)	X	X			X	

The following table shows the facility documentation requirements:

Table 3-8: Other Facility Documentation Requirements

Documentation Item (by facility type)	Stage			Location of Information		
	Preliminary Review	PS&E Review	Field Changes	Construction Plans	Permanent File	Report
Other Facilities						
Drainage area maps	X	X	X	X	X	X
Design criteria/parameters/assumptions	X	X	X		X	X
Hydrologic computations	X	X	X	X	X	X
Hydraulic computations	X	X	X	X	X	X
Plan/profile and details	X	X	X	X		X
Design and check flood before and after conditions (highwater, velocities, etc.)	X	X	X	X	X	X

The following table shows the SW3P Layout requirements for projects requiring authorization under the Construction General Permit (TXR150000):

Table 3-9: SW3P Layout Requirements

Documentation Item (by facility type)	Stage			Location of Information		
	Preliminary Review	PS&E Review	Field Changes	Construction Plans	Permanent File	Report
SW3P Layouts						
Drainage patterns	X	X	X	X	X	X
Approximate slopes anticipated after major grading activities	X	X	X	X	X	X
Areas that will and will not be disturbed	X	X	X	X	X	X
Locations where storm water will discharge from the project (i.e. discharge points)	X	X	X	X	X	X
Acres of disturbed area that will drain to each discharge point ¹	X	X	X	X	X	X
Locations of all major BMPs (e.g. silt fence, rock berm, sediment traps, etc.) ²	X	X	X	X	X	X
Areas that will receive temporary or permanent stabilization (e.g. temporary seeding, soil retention blankets, slope texturing, etc.) ³	X	X	X			X
Locations of surface waters and wetlands on or adjacent to the site (if known)	X	X	X	X	X	X
Names of surface waters that will receive discharge from the project ¹	X	X	X	X	X	X

¹Alternatively, this could be included in the SW3P Summary Sheet

²Structural controls are required at all down slope boundaries, and side slope boundaries as appropriate. Velocity dissipation devices at discharge locations are required if necessary to provide a non-erosive flow velocity from the structure to a watercourse. If it will be necessary to pump or channel standing water from the site, controls to remove sediment from this water are required. BMPs may also be used to divert storm water around disturbed areas.

³Temporary stabilization is required when work in a disturbed area will cease for more than 21 days.

The following table shows the SW3P Summary Sheet requirements for projects requiring authorization under the Construction General Permit (TXR150000):

Table 3-10: SW3P Summary Sheet Requirements

Documentation Item (by facility type)	Stage			Location of Information		
	Preliminary Review	PS&E Review	Field Changes	Construction Plans	Permanent File	Report
SW3P Summary Sheet						
If there are more than 10 disturbed acres that drain to a single discharge point, and if it is not possible to install a sediment basin that provides storage for the runoff from a 50%AEP, 24-hour storm per acre drained, a reason why such a basin is not feasible ¹	X	X	X	X	X	X
A description of the nature of the construction activity	X	X	X	X	X	X
Description of controls to reduce off site tracking of sediment	X	X	X	X	X	X
Description of construction and waste materials expected to be stored on-site and a description of controls to minimize pollutants from these materials.	X	X	X	X	X	X
A list of other potential pollutants and their sources, and description of controls to minimize pollutants from these sources ²	X	X	X	X	X	X
Total acreage of the project area	X	X	X	X	X	X
Total acreage of the project area that will be disturbed	X	X	X			X
Description of the soil or quality of the existing discharge from the site ³	X	X	X	X	X	X
A description of the intended schedule or sequence of activities that will disturb soils for major portions of the site. ⁴	X	X	X	X	X	X

¹Acceptable reasons include soils type, slope, available area, public safety, precipitation patterns, site geometry, site vegetation, infiltration capacity, geotechnical factors, depth to groundwater, and other similar considerations.

²Consider if the following may be a potential pollutant: sediment, oil and grease, coolant, pathogens, concrete truck wash-out, nutrients, etc. Effective controls may include requiring the contractor to maintain equipment free of leaks, develop a spill response plan, cover stored material/chemicals, prohibit concrete wash out in the rain or within a certain distance of waterways, prohibit the storage of materials/chemicals on a paved surface, prohibit application of fertilizer when rain is forecast or in excess of required amounts, etc.

³Consider whether or not preexisting conditions indicate the discharges from the area already contain excessive sediment, or if the site will be unusually vulnerable to erosion during construction.

⁴The sequences of disturbance and BMP implementation should correspond. For example, “Silt fence and rock berm will be installed prior to initial clearing and grading...after final grading, permanent seeding will be employed.”

Table 3-10: SW3P Summary Sheet Requirements

Documentation Item (by facility type)	Stage			Location of Information		
	Preliminary Review	PS&E Review	Field Changes	Construction Plans	Permanent File	Report
SW3P Summary Sheet						
A description of the intended sequence of erosion and sediment control BMP implementation ⁴	X	X	X	X	X	X
A note that the contractor will be responsible for compliance with all applicable environmental laws, rules and regulations for any work not described in the plans.	X	X	X	X	X	X
A note that the contractor is responsible for installing and maintaining BMPs as described in the plans and as directed by TxDOT personnel.	X					

¹Acceptable reasons include soils type, slope, available area, public safety, precipitation patterns, site geometry, site vegetation, infiltration capacity, geotechnical factors, depth to groundwater, and other similar considerations.

²Consider if the following may be a potential pollutant: sediment, oil and grease, coolant, pathogens, concrete truck wash-out, nutrients, etc. Effective controls may include requiring the contractor to maintain equipment free of leaks, develop a spill response plan, cover stored material/chemicals, prohibit concrete wash out in the rain or within a certain distance of waterways, prohibit the storage of materials/chemicals on a paved surface, prohibit application of fertilizer when rain is forecast or in excess of required amounts, etc.

³Consider whether or not preexisting conditions indicate the discharges from the area already contain excessive sediment, or if the site will be unusually vulnerable to erosion during construction.

⁴The sequences of disturbance and BMP implementation should correspond. For example, “Silt fence and rock berm will be installed prior to initial clearing and grading...after final grading, permanent seeding will be employed.”

Chapter 4 — Hydrology

Contents:

[Section 1 — Hydrology’s Role in Hydraulic Design](#)

[Section 2 — Probability of Exceedance](#)

[Section 3 — Hydrology Policies and Standards](#)

[Section 4 — Hydrology Study Requirements](#)

[Section 5 — Hydrology Study Data Requirements](#)

[Section 6 — Design Flood and Check Flood Standards](#)

[Section 7 — Selection of the Appropriate Method for Calculating Runoff](#)

[Section 8 — Validation of Results from the Chosen Method](#)

[Section 9 — Statistical Analysis of Stream Gauge Data](#)

[Section 10 — Regression Equations Method](#)

[Section 11 — Time of Concentration](#)

[Section 12 — Rational Method](#)

[Section 13 — Hydrograph Method](#)

[Section 14 — References](#)

[Section 15 — Glossary of Hydrology Terms](#)

Section 1 — Hydrology's Role in Hydraulic Design

In the context of hydraulic design, hydrologic analysis provides estimates of [flood](#) magnitudes as a result of precipitation. These estimates consider processes in a watershed that transform precipitation to runoff and that transport water through the system to a project's location.

The design of drainage facilities requires the designer to:

- ◆ Select the level of protection desired, specified in terms of probability of capacity exceedance.
- ◆ Find the corresponding flow rate and/or volume, computing in many cases the corresponding water surface elevation.
- ◆ Use that as a basis for design.

In the design of facilities such as storm drain systems, culverts, and bridges, floods are usually considered in terms of peak runoff or discharge in cubic feet per second or cubic meters per second. For systems that are designed to control the volume of runoff, such as detention storage facilities, or where flood routing through culverts is used, the discharge per time will be of interest. Thus, depending on the needs of a particular project, the hydrology study may provide:

- ◆ A flow rate for which the [probability of exceedance](#) is specified.
- ◆ A volume of water expected with a specified storm duration, for which the probability of exceedance is specified.
- ◆ A [hydrograph](#)—flow rate as a function of time—for a specified probability of exceedance. This provides information about peak, volume, and timing of runoff level of protection desired.

These results may be obtained through statistical analysis of historical observations or through empirical or conceptual models of the relevant watershed and channel processes.

Section 2 — Probability of Exceedance

The probability of exceedance describes the likelihood of a specified flow rate (or volume of water with specified duration) being exceeded in a given year. The probability of capacity exceedance describes the likelihood of the design flow rate (or volume of water with specified duration) of a hydraulic structure being exceeded in a given year.

Annual Exceedance Probability (AEP)

In this manual the preferred terminology for describing the probability of exceedance is annual exceedance probability (AEP).

There are several ways to express AEP. The TxDOT preferred unit for expressing AEP is percent. An event having a 1 in 100 chance of occurring in any single year will be described in this manual as the 1% AEP event. Annual recurrence interval (ARI), or return period, is also used by designers to express probability of exceedance. A 5-year return interval is the average number of years between years containing one or more events exceeding the specified AEP. Lastly, AEP can also be expressed as probability (a number between 0 and 1), such as $p = 0.01$. Examples of equivalent expressions for exceedance probability for a range of AEPs are provided in Table 4-1.

Table 4-1: Three Ways to Describe Probability of Exceedance

AEP (as percent)	AEP (as probability)	Annual recurrence interval (ARI)
50%	0.50	2-year
20%	0.20	5-year
10%	0.10	10-year
4%	0.04	25-year
2%	0.02	50-year
1%	0.01	100-year

While AEP, expressed as a percent, is the preferred method for expressing probability of exceedance, there are instances in this manual where other terms, such as those in Table 4-1, are used. These instances include equation subscripts based on return period, plot axes generated by statistical software, and text and tables where readability was improved as a result.

Design AEP

The designer will determine the required level of protection to be provided by a hydraulic structure. The level of protection is expressed as the design AEP. The designer will apply principles of

hydrology to determine flows and volumes corresponding to the design AEP. The purpose of most structures will be to provide protection against, or prevent, high stages; resulting from the design AEP event.

If stage is primarily dependent on flow rate, as is the case in a free-flowing channel, then the designer will estimate the peak flow value corresponding to the design AEP. If stage is primarily dependent on accumulated volume, as is the case with a storage facility, then the designer will seek to estimate the flow volume and duration corresponding to the design AEP.

Flows with computed AEP values can be plotted as a flood frequency curve as illustrated in Figure 4-1. In this example, the discharge is plotted on a logarithmic scale and AEP is plotted on a probability scale. As would be expected the curve indicates that flow increases as AEP decreases.

The AEP scale ranges from 100% to 0% (shown in Figure 4-1 as 1 to 0). The AEP axis is symmetrical about the 0.5 AEP position. For example, the horizontal distance between AEP of 0.5 and 0.95 equals the distance between 0.5 and 0.05.

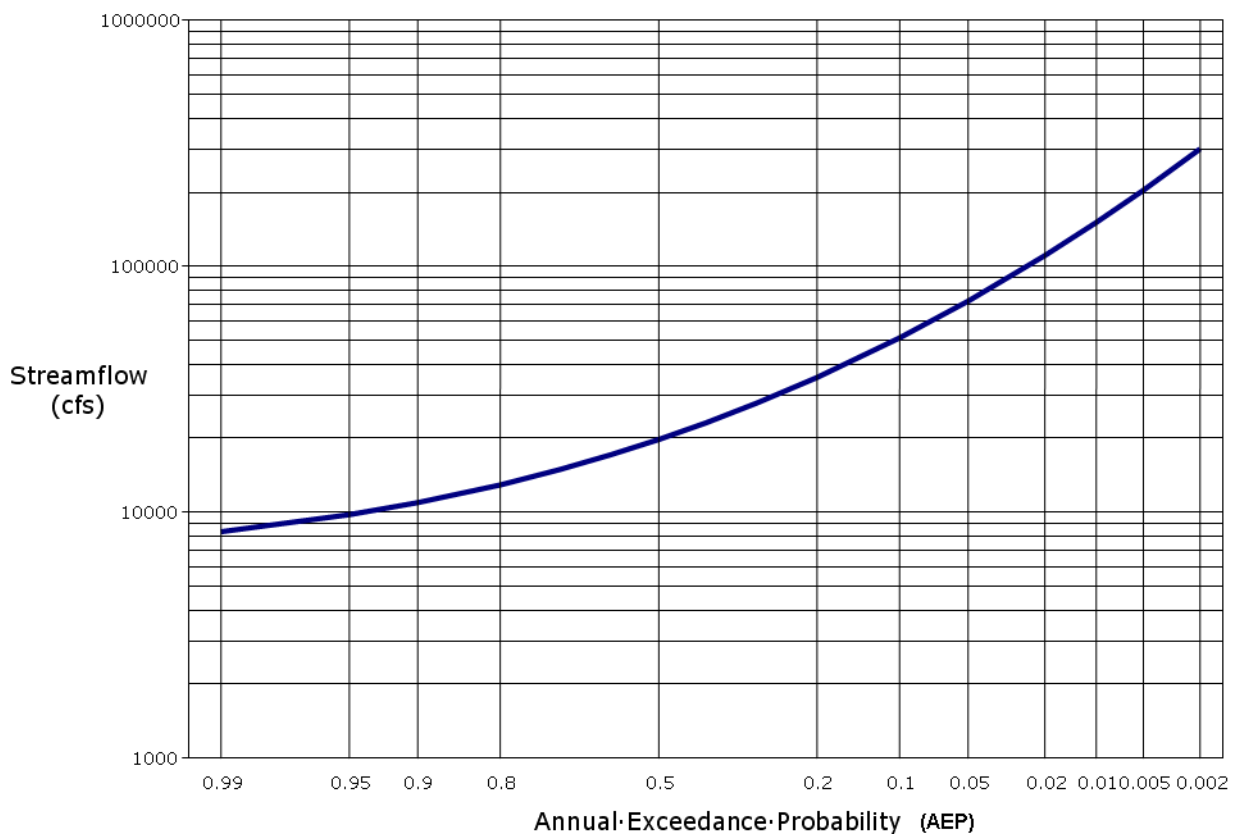

Figure 4-1. Typical flood frequency curve

Accuracy

The peak discharges determined by analytical methods are approximations. The drainage system will rarely operate at the design discharge. Flow will always be more or less in actual practice,

merely passing through the design flow as it rises and falls. Thus, the design engineer should not overemphasize the accuracy of the computed discharges. The design engineer should emphasize the design of a practical and hydraulically balanced system based on sound logic and engineering.

Section 3 — Hydrology Policies and Standards

TxDOT uses the drainage practices and design standards described in this manual for designing drainage facilities and flood control works associated with transportation projects. They are also used for evaluating the design, construction, and performance of projects in TxDOT's right-of-way.

General Guidelines

The designer should keep the following in mind when using this manual:

- ◆ The standards and methods in this manual are aimed at sound planning and design; they are guidelines rather than steadfast rules.
- ◆ The design standards in this chapter represent minimums. Alternatives that meet a higher standard than presented herein may be approved by the TxDOT district office.
- ◆ Exceptions to these design criteria may be allowed by TxDOT when they are in the best interest of the public and the alternative will be equivalent to the normally accepted method.
- ◆ Errors in peak flow estimates, whether due to computational errors or errors in judgment, may result in a drainage structure that is either undersized, which could cause drainage problems, or oversized, which costs more than necessary. On the other hand, any hydrologic analysis is only an approximation. Although some hydrologic analysis is necessary for all highway drainage facilities, the extent of such studies should be commensurate with the hazards associated with the facilities and with other concerns, including engineering, economic, social, and environmental factors.
- ◆ Design details are the responsibility of the design engineer and will be determined by good engineering practice.

Third Party Studies

If third party studies (previous studies by others) are available and appropriate for the project area, TxDOT may, but is not required to, use these studies. In some circumstances, TxDOT may be required to use third party studies, such as for compliance with the [Federal Emergency Management Agency's \(FEMA\) National Flood Insurance Program \(NFIP\)](#). The use of third party studies should be cleared with the district office.

Hydraulic Design for Existing Land Use Conditions

All drainage facilities shall be designed for existing land use conditions. Drainage design must include capacity to convey runoff from all existing adjacent properties. The district office may consider runoff from future land use conditions at its discretion after consulting with and receiving approval from the District Hydraulics Engineer (DHE.)

Effect on Existing Facilities

TxDOT drainage projects must be designed so that they do not have a negative impact on existing facilities either upstream or downstream of the project. A channel's [hydraulic grade line](#) must be checked to ensure that a flooding problem is not propagated upstream. The designer must define the upstream and downstream water surfaces until the effects of the new drainage facility match the pre-project hydraulic grade line. The proposed project must not induce flooding during the event for which it was designed.

Section 4 — Hydrology Study Requirements

The design engineer must coordinate with the district office at the beginning of a hydrology study to establish study requirements. Typically, TxDOT requires the designer to:

- ◆ Select an appropriate frequency for the event that will be the basis for design or evaluation, considering the risk of capacity exceedance. The event selected may range from one with a 50% [AEP](#) (2-year event) to one with a 1% AEP (100-year event). ([Design Flood and Check Flood Standards](#) provides guidance on selection of the risk-based flood event.)
- ◆ Choose an appropriate hydrologic analysis method, following guidance given herein, and use that method to compute the flow for the selected frequency.
- ◆ Explain and justify all assumptions. This includes explaining and justifying choice of the analysis method and choice of parameters and other inputs used with the methods.
- ◆ Verify and support results. This may be accomplished, in part, by demonstrating that the method used for design flow computation also can reproduce observed streamflow. Or it may be accomplished by comparing results of the selected method with those of valid alternative methods or other studies for nearby locations to establish confidence in results. (Driveway culverts and storm drains may be exempted from this requirement.)
- ◆ Provide, in reports and on plan sheets, information to enable a reviewer to understand and to reproduce the results. When using computer software for the computations, this will require the designer to identify the program used and version, to display all relevant input values, and to specify options and methods used in the software.
- ◆ Calculate flows for flood frequencies larger than and smaller than the selected design level, repeating the tasks described above. This will provide the designer with information for testing the resiliency and robustness of designs.

Section 5 — Hydrology Study Data Requirements

Strictly speaking, the term data refers to measurements or observations, and the term information refers to results of analysis or synthesis of data. Both data and information are needed for hydrologic studies, and the terms are used interchangeably here. To determine what data are needed, the designer must determine which hydrologic analysis method(s) will be used.

The major task of a hydrology study is to compute design flow. There are conceptual methods and empirical methods for computation of design flow.

Hydrology Analysis Methods

Conceptual methods in this category simulate, with a mathematical model, channel flow and watershed runoff processes. Movement and storage of water through the watershed are simulated at varying time and space scales, with varying degrees of complexity, omitting, including, or combining elements, depending on the model used and the requirements of the study.

Conceptual methods that TxDOT designers may use include the [rational method](#) (loosely classified as a conceptual method here) and the [hydrograph method](#).

Like conceptual methods, empirical methods also use a mathematical relation that predicts the design flow, given properties of the watershed, channels, rainfall, or streamflow. However, the relationship does not represent explicitly the physical processes. Instead, the relationships are derived with statistical analyses. (Some analysts even refer to empirical methods as black box methods because the presentation of the process is not visible and obvious.)

Empirical methods that TxDOT designers may use include [flood frequency analysis](#) of streamflow observations and [regression equations](#). With flood frequency analysis, the empirical relationship predicts the design flow from statistical properties of the historical streamflow in the watershed. With regression equations, the design flow is predicted with an equation that is developed by correlating flows observed with watershed, channel, and rainfall properties.

Data Requirements Vary with Method Used

Data and information required for hydrologic analysis varies from method to method. The conceptual methods require somewhat detailed information about the watershed and channel properties, whereas the empirical methods require streamflow data to establish the relationships and only limited data on watershed and channel properties to use the derived relationship.

Specific requirements for the different methods are called out in later sections of this Chapter, but broad categories of data required include the following:

- ◆ [Geographic and geometric properties of the watershed](#).

- ◆ [Land use, natural storage, vegetative cover, and soil property information.](#)
- ◆ [Description of the drainage features of the watershed.](#)
- ◆ [Rainfall observations and statistics of the precipitation.](#)
- ◆ [Streamflow observations and statistics of the streamflow.](#)

Geographic and Geometric Properties of the Watershed

All hydrologic analyses for TxDOT studies require collection of data about the geographic and geometric properties of the watershed. These data include, but are not limited to, the following:

- ◆ Geographic location of the point at which design flow must be computed.
- ◆ Location of the boundaries of the watershed from which runoff contributes to flow at the point of interest. This information will, for example, govern selection of design rainfall intensities that will be used with the [rational method](#) if that is selected for design flow computation.
- ◆ Properties of the watershed within those boundaries. These properties include area, slope, shape, and topographic information. This information is needed, for example, to develop a model with which to simulate overland flow, as shown in [Figure 4-9](#) whereby water ponded on the surface moves across the watershed into channels.

Land Use, Natural Storage, Vegetative Cover, and Soil Property Information

Data that describe the watershed properties are needed for the conceptual models, and to a limited extent, by certain empirical models.

A conceptual model of watershed runoff, with components as illustrated in Figure 4-9, represents processes of infiltration and overland flow. To do so, the model must be configured and calibrated with knowledge of the properties of the watershed that will affect infiltration and overland flow.

Those include:

- ◆ Land use in the watershed. Especially important in this is gathering information about the distribution of impervious and pervious cover in the watershed. Rain that falls on impervious surfaces, such as parking lots and rooftops, will run off as overland flow. Rain that falls on a pervious surface may infiltrate, entering the soil layers, and not running off immediately or at all. The rate of this infiltration is related with land use, as well.
- ◆ Natural storage in the watershed. Water that ponds in natural depressions, lakes, and similar features in a watershed will not run off or may runoff with some delay and with reduced rates. The location of, capacities of, and behavior of storage must be identified if this is to be represented in computations of design flows.
- ◆ Vegetative cover and soil property information. Rates of infiltration depend on properties of soils in the watershed and upon the presence of vegetation. For example, water ponded on sandy soils may infiltrate at four or five times the rate of water ponded on clay soils. And crops

planted on clay soils will increase the rate of infiltration there. Thus, the designer must gather information on the cover and soils. That information should define the spatial variations across the watershed.

These data are needed with conceptual models that do not seek to represent in great detail the physical processes. For example, with the [rational method](#), a runoff coefficient relates runoff rate and rainfall rate. That coefficient is related to land use within the watershed. And knowledge of land use, particularly knowledge of presence or absence of impervious area, is critical for assessing the applicability of [regression equations](#).

Description of the Drainage Features of the Watershed

Channels, ponds, reservoirs, culverts, and other natural or constructed drainage features in a watershed affect the runoff from the watershed. Thus data that describe those must be collected.

For a conceptual model, data about the features are needed to make a decision about which model to use and configure the model appropriately. For example, with a [hydrograph method](#), data describing channels are needed to select, calibrate, and use a routing method that accounts for the impact of a channel on the design flood peak.

For an empirical model, data on drainage features is needed first to enable wise decisions about which model(s) to use, and second, to estimate model parameters. For example, [flood frequency \(stream gauge\) analysis procedures](#) require that the streamflow records be without significant regulation. To determine if this is so, the designer must have information on regulation in the watershed, including descriptions of ponds, reservoirs, detention structures, and diversions in the watershed.

Rainfall Observations and Statistics of the Precipitation

Conceptual models simulate conversion of rainfall to runoff by simulating some or all of the processes illustrated in [Figure 4-9](#). Thus, to use a conceptual model, rainfall data are required. These data include both observations of rainfall at gauges in the watershed and statistics on rainfall from which [design storms](#) are developed.

With observations of rainfall at gauges, models can be calibrated and tested to ensure that they truly represent the behavior of the watershed.

With statistics of rainfall depths, a design storm can be developed, and the required design flow can be computed following the design storm assumption. This assumption is that “if median or average values of all other parameters are used, the frequency of the derived flood should be approximately equal to the frequency of the design rainfall” (Pilgrim and Cordery 1975).

Streamflow Observations and Statistics of the Streamflow

Streamflow observations at or near to the location of interest are the designer's best index of how a watershed will behave under conditions existing in the watershed at the time of observation of the flow. These data serve the following purposes:

- ◆ Calibration of statistical model. If available, long records of annual maximum streamflow permit [flood frequency analysis](#) and design flow determination.
- ◆ Calibration and verification of conceptual model. Shorter records of runoff from individual floods permit calibration and verification of conceptual models of the rainfall to runoff transformation, if corresponding records of rainfall are available. In this process, model parameters are estimated, runoff from observed rainfall is computed, and the computed flows are compared to the observed. Parameters are adjusted if the fit is not acceptable.
- ◆ Assessment of reasonableness of results. Records of annual maximum flows at a site for limited periods permit assessment of reasonableness of predicted design flows. For example, if a record of annual maximum flows for 12 years at a site includes six peaks that exceed the predicted 10% chance design flow, a designer can apply the [binomial statistical distribution](#) to determine that the probability is only 0.0005 that this could happen. This is so unlikely that it raises doubt about the estimated 10% chance design flow.

Section 6 — Design Flood and Check Flood Standards

TxDOT’s approach to selecting the design standard for a drainage facility is to use a reference table that specifies a range of design [AEPs](#) for different types of facilities. Table 4-2 provides the design frequencies for TxDOT projects. For most types of facilities a range of design frequencies is presented. For those types of facilities with a range of possible design frequencies, usually one design frequency in the range is recommended (indicated by an X with square brackets in Table 4-2). Structures and roadways should be serviceable (not inundated) up to the design standard.

Table 4-2: Recommended Design Standards for Various Drainage Facilities

Functional classification and structure type	Design AEP (Design ARI)				
	50% (2-yr)	20% (5-yr)	10% (10-yr)	4% (25-yr)	2% (50-yr)
Freeways (main lanes):					
Culverts					X
Bridges					X
Principal arterials:					
Culverts			X	[X]	X
Small bridges			X	[X]	X
Major river crossings					[X]
Minor arterials and collectors (including frontage roads):					
Culverts		X	[X]	X	
Small bridges			X	[X]	X
Major river crossings				X	[X]
Local roads and streets:					
Culverts	X	X	X		
Small bridges	X	X	X		
Off-system projects:					
Culverts	FHWA policy is “same or slightly better” than existing.				X
Small bridges					X
Storm drain systems on interstates and controlled access highways (main lanes):					
Inlets and drain pipe			X		
Inlets for depressed roadways*					X

Table 4-2: Recommended Design Standards for Various Drainage Facilities

Functional classification and structure type	Design AEP (Design ARI)				
	50% (2-yr)	20% (5-yr)	10% (10-yr)	4% (25-yr)	2% (50-yr)
Storm drain systems on other highways and frontage roads:					
Inlets and drain pipe	X	[X]	X		
Inlets for depressed roadways*				[X]	X
Table 4-2 notes: * A depressed roadway provides nowhere for water to drain even when the curb height is exceeded. [] Brackets indicate recommended AEP. Federal directives require interstate highways, bridges, and culverts be designed for the 2% AEP flood event. Storm drains on facilities such as underpasses, depressed roadways, etc., where no overflow relief is available should be designed for the 2% AEP event.					

All facilities must be evaluated to the 1% AEP flood event.

Selecting a design flood is a matter of judgment; it requires balancing the flood risk with budgetary constraints. When considering the standard for a drainage facility, the designer should follow these guidelines:

- ◆ Decide on the design standard by considering the importance of the highway, the level of service, potential hazard to adjacent property, future development, and budgetary constraints.
- ◆ Develop alternative solutions that satisfy design considerations to varying degrees.
- ◆ After evaluating each alternative, select the design that best satisfies the requirements of the structure.
- ◆ Consider additional factors such as the design standards of other structures along the same highway corridor to ensure that the new structure is compatible with the rest of the roadway. Also assess the probability of any part of a link of roadway being cut off due to flooding.

The designer should design a facility that will operate:

- ◆ Efficiently for floods smaller than the design flood.
- ◆ Adequately for the design flood.
- ◆ Acceptably for greater floods.

In addition, for all drainage facilities, including storm drain systems, the designer must evaluate the performance for the check flood (1% AEP event). The purpose of the check flood standard is to ensure the safety of the drainage structure and downstream development by identifying significant risk to life or property in the event of capacity exceedance.

The intent of the check flood is not to force the 1% AEP through the storm drain, but to examine where the overflow would travel when this major storm does occur. For example, the water may

travel down the gutter to the same creek as the outfall, travel down a driveway and directly into a home, inundate the mainlanes, erode a new drainage path to the outfall, or other problems.

The examination of the check flood should also include assessment of the tailwater. There may be locations on the project that are lower than the 100 year water surface elevation (or tailwater) of the creek. This situation may increase the hydraulic grade line through the storm drain system, or may even cause negative flow through the system. This may cause blowouts which may in turn cause any of the same problems as above.

Section 7 — Selection of the Appropriate Method for Calculating Runoff

The designer is expected to select an appropriate hydrologic analysis method for each project, seeking assistance from the DHE or DES-HYD and other resources, as needed. TxDOT has no standard method, realizing that methods used must satisfy the requirements of individual studies.

To select the appropriate method, the TxDOT designer should consider, at a minimum, the following:

- ◆ Information required for design or evaluation and where that information is needed. For example, if the TxDOT project requires designing a culvert, the [rational method](#), which computes peak only, may be adequate. However, if the TxDOT project is affected by or will affect behavior of a detention or retention pond, a runoff [hydrograph](#) will be required for the evaluation.
- ◆ Data available to develop the required hydrologic information. For example, the designer must determine if flow records are available from a stream gauge at or near the location of interest. If not, [frequency analysis](#) to find the design flow is not possible, nor is proper calibration of a conceptual model that will compute a hydrograph.
- ◆ Conditions in the watershed that may limit applicability of alternative models. For example, [regression equations](#) for Texas were estimated for watersheds with less than 10 percent impervious cover. If the watershed upstream of the point of interest has more impervious cover, the equations are not applicable. Similarly, if ponds, lakes, and depressions in the watershed will affect runoff by storing water, the rational equation will not be appropriate, as it does not simulate behavior of these features.

Methods acceptable for estimating peak discharges and runoff hydrographs for TxDOT design and evaluation include, but are not limited to the following:

- ◆ [Statistical Analysis of Stream Gauge Data](#). This empirical method calibrates a probability model with peak annual discharge observations. The probability model relates design flow magnitude to frequency directly, without explicit consideration of rainfall or watershed properties or processes. The method is particularly useful where records in excess of 20 years of stream gauge data are available at or on the same stream near the drainage facility site.
- ◆ [Omega EM Regression Equations](#). This empirical method relies on application of equations, previously developed through extensive statistical analysis, to predict the peak discharge for a specified frequency (TxDOT 0-5521-1). The equations relate the peak to watershed properties, including watershed area, mean annual precipitation, and main channel slope. This method is useful if streamflow data are not available at or near the project site, or other methods are judged inappropriate. TxDOT designers may use Omega EM regression equations for validation and verification of results from other methods, or for computation of flows for limited detail evaluation of impacts of TxDOT designs on off-system facilities. Omega EM regression equations are reliable beyond about 10 sq. mi. drainage area. A comparison method should be

used for drainage areas below 10 sq. mi., and must be used for drainage areas below about 5 sq. mi. This method should not be used for drainage areas less than 1 sq. mi.

- ◆ **Rational Method**. This simple conceptual method estimates peak runoff rate for a selected frequency. It is appropriate for urban and rural watersheds less than 200 acres (80 hectares) in which natural or man-made storage is minor. It relies on an assumption that the design flow of a specified frequency is caused by rainfall of the same frequency. This method is best suited to the design of urban storm drain systems, small side ditches and median ditches, and driveway pipes.
- ◆ **Hydrograph Method**. This conceptual method (actually, a set of methods and models) relies on a mathematical representation of the critical processes by which rainfall on a watershed is transformed to runoff from the watershed. The method is used with a design rainfall hyetograph, which specifies the time distribution of rainfall over a watershed. The method computes a runoff hydrograph, which shows how runoff varies with time; from that, the peak flow, time of peak, and corresponding volume can be found.

Figure 4-2 is a flowchart to aid the designer in selecting an appropriate hydrologic method from among these. The designer must ensure that the conditions in the watershed conform to the limitations of the selected hydrologic method, as described in detail in the sections that follow.

The TxDOT designer is not limited to using only the methods shown here. If none of the methods is judged appropriate, the designer may use an alternative method, with the approval of the DHE or DES. In every case, the rationale for selecting the method must be presented as a component of the design report.

The TxDOT designer should:

- ◆ Identify and apply alternative methods, recognizing that these will yield different results.
- ◆ Compare the results from several methods and the historical performance of the site.
- ◆ Use the discharge that best reflects local project conditions. Averaging of results of several methods is **not** recommended.
- ◆ Document the reasons for selection of the methods and the historical performance of the site.

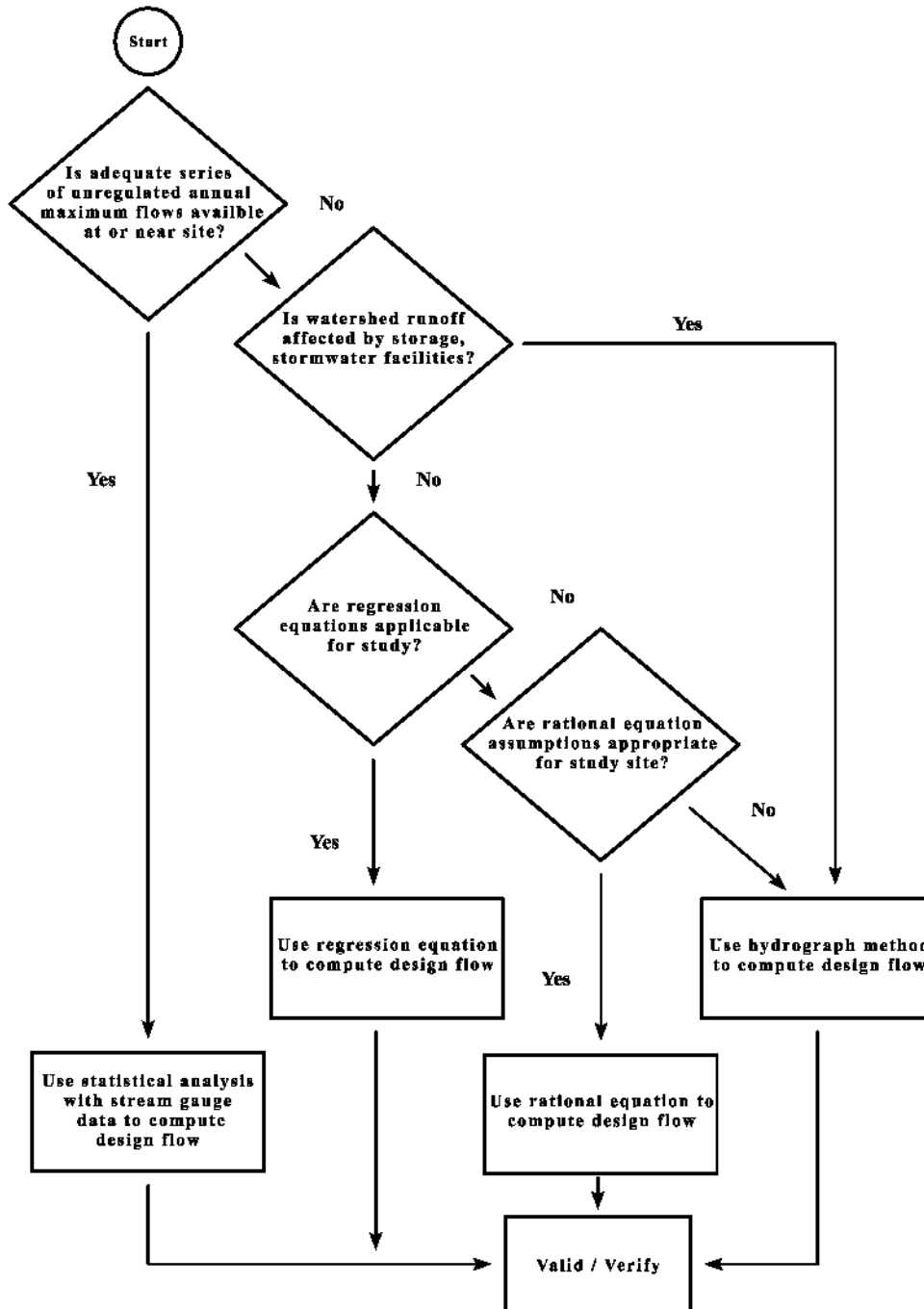

Figure 4-2. Hydrologic method selection chart

Section 8 — Validation of Results from the Chosen Method

Design flows estimated with any method used should be confirmed and validated. This may be achieved by:

1. Comparing the predicted design flow for the selected frequency with observed flows to assess reasonableness. The binomial distribution, which is available as a function in most spreadsheet software, is helpful for this assessment. It computes the probability of y exceedances in a given period of n years of a design event that has an [AEP](#) of p as:

$$P = \frac{n!}{y!(n-y)!} p^y (1-p)^{n-y}$$

Equation 4-1.

Where:

P = probability (0 to 1) of y exceedances in n years for design level p

y = number of design exceedances

n = number of years

p = Design AEP (0 to 1)

Note that p in this equation is AEP and ranges from 0 to 1. So for this equation, p is the selected design frequency divided by 100.

Suppose, for example, that in a 20-year long record of observed flows, the computed 1% AEP flow was found to have been exceeded in three years. With the binomial distribution, the probability of this is computed as 0.001 or about one chance in 1000. This is so unlikely that it raises doubt about the estimate of the 1% chance flow, suggesting that the computed design flow is too low. Fewer exceedances would be reasonable.

Similarly, suppose that the 10% AEP design flow was not exceeded at all in a 30-year-long record. The binomial distribution shows that the probability of no exceedances of the 10% AEP (10-year) flow in 30 years is 0.04—again an unlikely scenario. This suggests that the 10% flow predicted is too high; more exceedances would be reasonable.

2. Comparing the design flow computed with the selected method with those computed for the same AEP for watersheds with similar properties in other studies in the region. A “flow per unit area” comparison is useful. Significant differences should be investigated and explained.
3. Comparing the results of other methods, if those are appropriate. For example, in some cases, both the [rational method](#) and the [regression equations](#) will be acceptable for design flow computation. Or if a frequency function is fitted with statistical methods, the design flows can be [transposed](#) from the gauged site to the location of interest, using methods described later in this manual.
4. Comparing the design flow computed with the selected method to design flow for the same frequency computed by other agencies with different methods. These may include local public

works agencies, the [United States Army Corps of Engineers](#) (USACE), the [FEMA](#), and the [Natural Resource Conservation Service](#) (NRCS). Significant differences should be investigated and explained.

The results of these alternative methods can be compared. Again, significant differences should be investigated and explained.

Section 9 — Statistical Analysis of Stream Gauge Data

If the gauging record covers a sufficient period of time, it is possible to develop a flow-frequency relation by statistical analysis of the series of recorded annual maximum flows. The designer can then use the flow-frequency relation in one of two ways:

- ◆ If the facility site is near the gauging station on the same stream and watershed, the designer can directly use the discharge obtained from the flow-frequency relation for the [design AEP](#).
- ◆ If the facility site is on the same stream, but not proximate to the gauging station, it may be possible to [transpose gauge analysis results](#).

Widely accepted and applied guidelines for statistical analyses of stream gauge data are published in Guidelines for Determining Flood Flow Frequency, [Bulletin #17B](#) (IACWD 1982). Procedures from Bulletin #17B, with some Texas-specific refinements, as outlined in this manual, are recommended. They include:

- ◆ Obtaining a sufficiently large sample of streamflow data for [statistical analysis](#),
- ◆ Using the [log-Pearson type III](#) distribution fitting procedure,
- ◆ Using a weighted [skew](#) value,
- ◆ [Accommodating outliers](#),
- ◆ [Transposing](#) gauge analysis results, if necessary and appropriate.

Data Requirements for Statistical Analysis

The greatest challenge in applying the statistical analysis of stream gauge data is obtaining a sufficiently large sample of streamflow measurements (or estimates) so that the sample is representative of the entire population of flows. Two types of data may be considered (IACWD 1982), systematic data and historical data.

Systematic data are flow records generated from a defined set of rules and recorded on a regular basis. For example, the [United States Geological Survey](#) (USGS) annual maximum flow record for a gauge consists of the maximum instantaneous flow value for each year, recorded every year over a given time period. If annual maximum flow values were recorded only for years in which large events occurred, then the record would no longer be systematic. Gaps (missing years) in the systematic record do not preclude use of such data so long as the gaps are the result of missing data, and not the result of filtering the data based on flow magnitude.

Historical data are flow estimates for events not included in the systematic record. These data typically consist of historically significant events, and thus are a sample of extreme events observed by locals. Historical data should be included in the analysis when possible. In cases where only a short systematic record is available, historical data are particularly valuable. Use of historical data also

ensures that the results of the analysis will be consistent with the experience of the local community (IACWD 1982).

For highway drainage design purposes, a statistical analysis of stream gauge data is typically applied only when adequate data from stream gauging stations are available. The definition of adequate data comes from USGS practice and is provided in Table 4-3.

Table 4-3: Recommended Minimum Stream Gauge Record Lengths (Dalrymple and Benson 1960)

Desired percent chance exceedance (ARI)	Minimum record length (years)
10-year	8
25-year	10
50-year	15
100-year	20

For TxDOT application, sources for annual peak flow data include:

- ◆ USGS [National Water Information System](#) (NWIS).
- ◆ US Department of the Interior, USGS [Water Resources Data](#) - Texas, Surface Water. These are prepared annually and contain records for 1 water year per publication. As a result, abstracting annual peaks for a long record is time consuming.
- ◆ [International Boundary and Water Commission](#) water bulletins.

If the available data sources allow the designer to construct a sufficiently large sample of annual peak streamflow values, then the following conditions must also be satisfied or accounted for before undertaking the statistical analysis:

- ◆ The data must be representative of the design condition of the watershed.
- ◆ The data must not be significantly affected by upstream regulation.
- ◆ The systematic record must be stationary, with no general trend of increasing or decreasing flows resulting from changes to the watershed.
- ◆ The data must be homogeneous, with flow values resulting from the same types of events. If annual peak flows can result from either rainfall or snowmelt, then a mixed population analysis may be required.
- ◆ Errors in flow measurements must not be significant relative to other uncertainties in the analysis.

Log-Pearson Type III Distribution Fitting Procedure

The log-Pearson type III (LPIII) statistical distribution method is recommended in [Bulletin #17B](#) and is the standard of practice for estimating annual [probability of exceedance](#) of peak flows. An

outline of this method follows. However, the designer is not limited to using this method, especially if the resulting flow-frequency relation does not seem to fit the data.

The following general procedure is used for LPIII analyses. Refer to Bulletin #17B for further information.

1. Acquire and assess the annual peak discharge record.
2. Compute the base 10 logarithm of each discharge value.
3. Compute the mean, standard deviation, and (station) [skew](#) of the log flow values.
4. Compute the weighted skew coefficient from the station skew and regional skew.
5. Identify high and low [outliers](#) from the sample set.
6. Recompute the mean, standard deviation, and station skew of the log flow values with outliers removed from the sample set.
7. Compute flow values for desired AEPs.

With the LPIII method, the logarithm of the discharge for any AEP is calculated as:

$$\log Q_p = \overline{Q}_L + KS_L$$

Equation 4-2.

Where:

\overline{Q}_L = mean of the logarithms of the annual peak discharges

Q_p = flood magnitude (cfs or m^3/s) of AEP p

K = frequency factor for AEP p and coefficient of skew appropriate for site

S_L = standard of deviation of logarithms of the annual peak discharges

See the spreadsheet [freqfrac.xls](#) for values of K , based on station skew coefficient.

The three statistical moments used to describe the LPIII distribution are the mean, standard deviation, and skew. Estimates of these moments for the distribution of the entire population of flows are computed for the available sample of flows with the equations below.

The mean is given by:

$$\overline{Q}_L = \frac{\sum X}{N}$$

Equation 4-3.

Where:

\overline{Q}_L = mean of the (base 10) logarithms of the annual peak discharges

X = logarithm of the annual peak discharge

N = number of observations

The standard deviation is given by:

$$S_L = \left\{ \frac{\sum x^2 - \frac{(\sum x)^2}{N}}{N-1} \right\}^{\frac{1}{2}}$$

Equation 4-4.

Where:

S_L = standard deviation of the logarithms of the annual peak discharge; N and X are defined as above

The coefficient of skew (station skew) is given by:

$$G = \frac{N^2(\sum X^3) - 3N(\sum X)(\sum X^2) + 2(\sum X)^3}{N(N-1)(N-2)S_L^3}$$

Equation 4-5.

Where:

G = coefficient of skew of log values; N , X , and S_L are defined as above

Skew represents the degree of curvature to the flow-frequency curve as shown in Figure 4-3. In Figure 4-3 the X-axis scale is probability (symmetric at about AEP = 0.5) and the Y-axis scale is base 10 logarithmic flow. A skew of zero results in a straight-line flow frequency curve. A negative skew value produces a flow-frequency curve with lesser flows than the zero skew line, and a positive skew produces a flow-frequency curve with greater flows than the zero skew line.

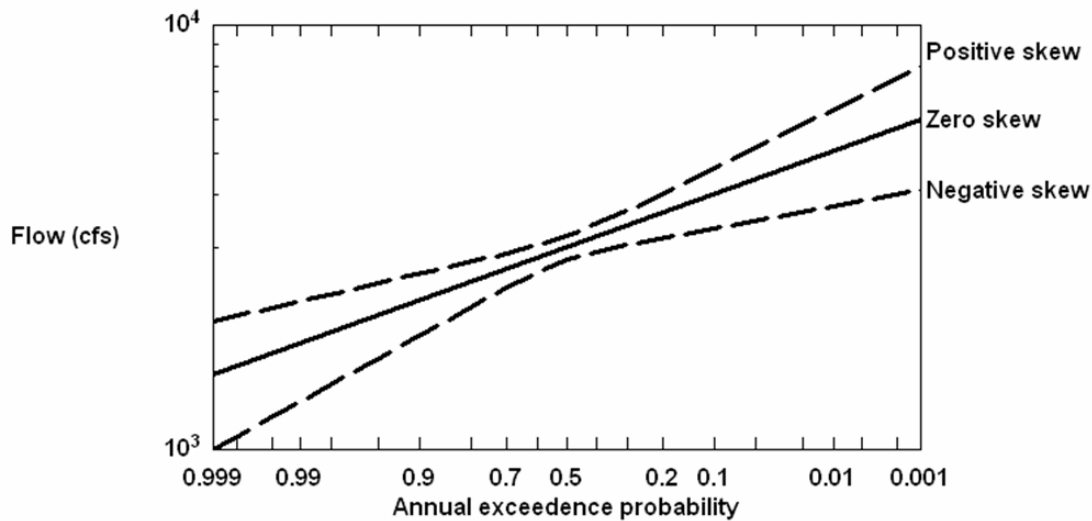

Figure 4-3. Skew of discharge versus frequency plots

The following cases require special consideration. [Bulletin #17B](#) provides further guidance:

- ◆ Record is incomplete—flows missing from record because too small or too large to measure (flows filtered from record based on flow magnitude).
- ◆ Record contains zero flow values—stream was dry all year.
- ◆ Record contains historical flows not recorded in a systematic fashion. Examples are extreme events recorded prior to or after installation of a stream gauge. These are indicated by code in USGS annual [peak discharge data](#).
- ◆ Flows are the result of two distinct types (a mixed population) of hydrologic events such as snowmelt and rainstorms.

Skew

Bulletin #17B recommends using the weighted skew value, G_w , to determine frequency factor values in Equation 4-2.

To calculate weighted skew, use this equation, and follow the steps provided in Bulletin #17B:

$$G_w = \frac{(MSE_{\bar{G}})(G) + (MSE_G)(\bar{G})}{MSE_{\bar{G}} + MSE_G}$$

Equation 4-6.

Where:

G_w = weighted skew value

\bar{G} = regional skew from Figure 4-4

G = station skew from Equation 4-5

$MSE_{\bar{G}}$ = mean square error of \bar{G} for Texas, is = 0.35 (Judd et al. 1996), which replaces the value of 0.55 presented in Bulletin #17B.

MSE_G = mean square error of G . MSE_G is a function of G and period of record

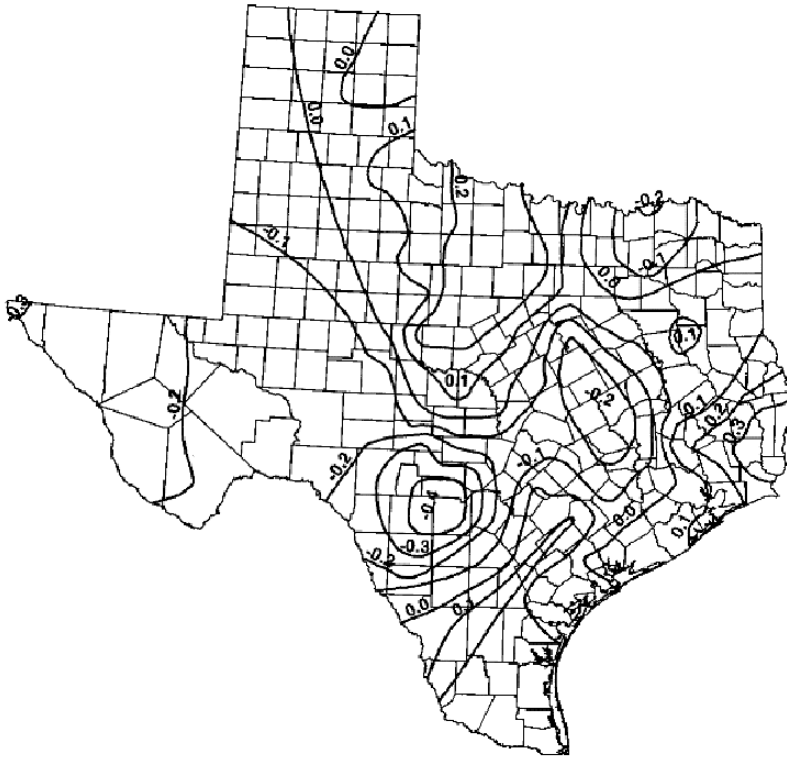

Figure 4-4. Generalized skew coefficients for Texas (Judd 1996) (\bar{G})

$$SE_G \approx 10 \left[A - B \left[\log \left(\frac{N}{10} \right) \right] \right]$$

Equation 4-7.

Where N is the record of length and

$$A = -0.33 + 0.08 |G| \text{ for } |G| \leq 0.90$$

$$A = -0.52 + 0.30 |G| \text{ for } |G| > 0.90$$

And

$$B = 0.94 - 0.26 |G| \text{ for } |G| \leq 1.50$$

$$B = 0.55 \text{ for } |G| > 1.50$$

Accommodation of Outliers

The distribution of all the annual and historical peak discharges determines the shape of the flow-frequency curve and thus the design-peak discharges. The shape of the frequency curve generated by a log-Pearson type III analysis is symmetrical about the center of the curve. Therefore, the distribution of the higher peak discharges affects the shape of the curve, as does the distribution of the lower peak discharges.

Flooding is erratic in Texas, so a series of observed floods may include annual peak discharge rates that do not seem to belong to the population of the series. The values may be extremely large or extremely small with respect to the rest of the series of observations. Such values may be outliers that should be excluded from the set of data to be analyzed or treated as historical data. [Bulletin #17B](#) calls for identification of these outliers.

Design flows are typically infrequent large flows. Therefore, it is desirable to base the frequency curve on the distribution of the larger peaks. This is accomplished by eliminating from the analyses peak discharges lower than a low-outlier threshold. The value for the low-outlier threshold, therefore, should exclude those peaks not indicative of the distribution for the higher peaks. This value is chosen by reviewing the sequentially ranked values for all peak discharges used in the analysis.

Equation 4-8 provides a means of identifying the low outlier threshold (Asquith et. al 1995):

$$LOT = 10^{(a\bar{Q}_L + bS_L + cG + d)}$$

Equation 4-8.

Where:

LOT = estimated low-outlier threshold (cfs)

\bar{Q}_L = mean of the logarithms of the annual peak discharge (see Equation 4-3)

S_L = standard deviation of the logarithms of the annual peak discharge (see Equation 4-4)

G = coefficient of skew of log values (station skew, see Equation 4-5)

$a = 1.09$

$b = -0.584$

$c = 0.140$

$d = -0.799$

This equation was developed for English units only and does not currently have a metric equivalent.

High outlier thresholds permit identification of extremely high peak discharges with probability smaller than indicated by the period of record for a station. For example, if a true 1% percent chance exceedance (100-year) peak discharge were gauged during a 10-year period of record, the

frequency curve computed from the 10 years of record would be unduly shaped by the 1% percent chance exceedance peak.

The [USGS](#) has made efforts to identify high outliers, referred to as historical peaks, by identifying and interviewing residents living proximate to the gauging stations. In many cases, residents have identified a particular flood peak as being the highest since a previous higher peak. These peaks are identified as the highest since a specific date.

In other cases, residents have identified a specific peak as the highest since they have lived proximate to the gauging station. Those peaks are identified as the highest since at least a specific date. The historical peaks may precede or be within the period of gauged record for the station.

Equation 4-9 provides a means of identifying the high outlier threshold (Bulletin #17B):

$$HOT = \bar{X} + K_N S_L$$

Equation 4-9.

Where:

HOT = estimated high-outlier threshold (logarithm of flow)

N = number of systematic peaks remaining in sample after previously detected outliers have been removed

\bar{X} = mean of the logarithms of the systematic annual peak discharges, with previously detected outliers removed

S_L = standard of deviation of the logarithms of the annual peak discharges

K_N = frequency factor for sample size N from Appendix 4 of Bulletin #17B

All known historical peak discharges and their associated gauge heights and dates appear on the [USGS Texas Water Science](#) web site.

To incorporate high outlier information when fitting the LPIII distribution according to [Bulletin #17B](#) procedures, the designer will:

- ◆ Use Equation 4-9 to define the high-outlier threshold.
- ◆ Collect supporting information about the identified high outlying flows.
- ◆ Retain as part of the systematic record any high outlying flows found not to be the maximum flow of record.
- ◆ Extend the period of record for the analysis to include the flow if the flow's value is found to be the maximum flow of record and lies outside the systematic record. If the value does lie within the systematic record, the period of record is not extended. In both cases, the designer shall recompute the LPIII parameters following the procedure described in Section V.A.9 and Appendix 6 of Bulletin #17B.

- ◆ Thoroughly document data, interviews, decisions, and assumptions used to justify the identification of high outliers and recomputation of LPIII parameters.

TxDOT recommends the use of hydrologic statistical analysis computer programs that can detect outlying values and recomputed LPIII parameters consistent with Bulletin #17B procedures.

Transposition of Gauge Analysis Results

If gauge data are not available at the design location, discharge values can be estimated by transposition if a peak flow-frequency curve is available at a nearby gauged location. This method is appropriate for hydrologically similar watersheds that differ in area by less than 50 percent, with outlet locations less than 100 miles apart.

From the research of Asquith and Thompson 2008, an estimate of the desired AEP peak flow at the ungauged site is provided by Equation 4-10:

$$Q_1 = Q_2 \sqrt{\frac{A_1}{A_2}}$$

Equation 4-10.

Where:

Q_1 = Estimated AEP discharge at ungauged watershed 1

Q_2 = Known AEP discharge at gauged watershed 2

A_1 = Area of watershed 1

A_2 = Area of watershed 2

Transposition of peak flow is demonstrated with the following example. A designer requires an estimate of the 1% AEP streamflow at an ungauged location with drainage area of 200 square miles. A nearby (within 100 miles) stream gauge has a hydrologically similar drainage area of 450 square miles. The 1% AEP peak streamflow at the gauged location is 420 cfs based on the peak flow-frequency curve developed for that location. Substituting into Equation 4-10 results in 280 cfs as an estimate of the 1% AEP peak discharge at the ungauged location:

$$Q_1 = Q_2 \sqrt{\frac{A_1}{A_2}} = 420 \sqrt{\frac{200}{450}} = 280$$

If flow-frequency curves are available at multiple gauged sites, Equation 4-10 can be used to estimate the desired peak AEP flow from each site. Then, with judgment and knowledge of the watersheds, those estimates could be weighted to provide an estimate of the desired AEP flow at the ungauged location. This process should be well documented.

Design of a storage facility, such as a detention pond, may require estimates of AEP flows for longer durations. If a flow-frequency curve for longer flow duration is available at a nearby gauged location, then Equation 4-11, based on an analysis of mean-daily flows (Asquith et al. 2006), may be used for transposition:

$$Q_1 = Q_2 \left(\frac{A_1}{A_2} \right)^{0.9}$$

Equation 4-11.

Section 10 — Regression Equations Method

Regression equations are recommended as the primary hydrologic method for off-system (non-TxDOT) projects; for on-system projects, they are recommended as a check on other methods. Omega EM regression equations are reliable beyond 10 sq. mi. drainage area. A comparison method should be used for drainage areas below 10 sq. mi. and must be used for drainage areas below about 5 sq. mi. This method should not be used for drainage areas less than 1 sq. mi.

If an adequate record of streamflow is not available at or near the project site, and LPIII distribution cannot be developed with Bullitin #17B procedures. An alternative for estimating the needed design flow is to use a regression equation.

Regression equations are used to transfer flood characteristics from gauged to ungauged sites through the use of watershed and climatic characteristics as explanatory or predictor variables. USGS has developed such regression equations for natural basins throughout the State of Texas.

Procedure for Using Omega EM Regression Equations for Natural Basins

Equations have been developed for natural basins in 1-degree latitude and longitude quadrangles in Texas. Figure 4-5 shows the geographic extents of each quadrangle. The approach used to develop the regional equations is referred to as the “Regression Equations for Estimation of Annual Peak-Streamflow Frequency for Undeveloped Watersheds in Texas Using an L-moment-Based, PRESS-Minimized, Residual-Adjusted Approach.” (USGS 2009) For development and use of regression equations a natural basin is defined as having less than 10 percent impervious cover, less than 10 percent of its drainage area controlled by reservoirs, and no other human-related factors affecting streamflow (USGS 2001). The equations are therefore not applicable to urban watersheds.

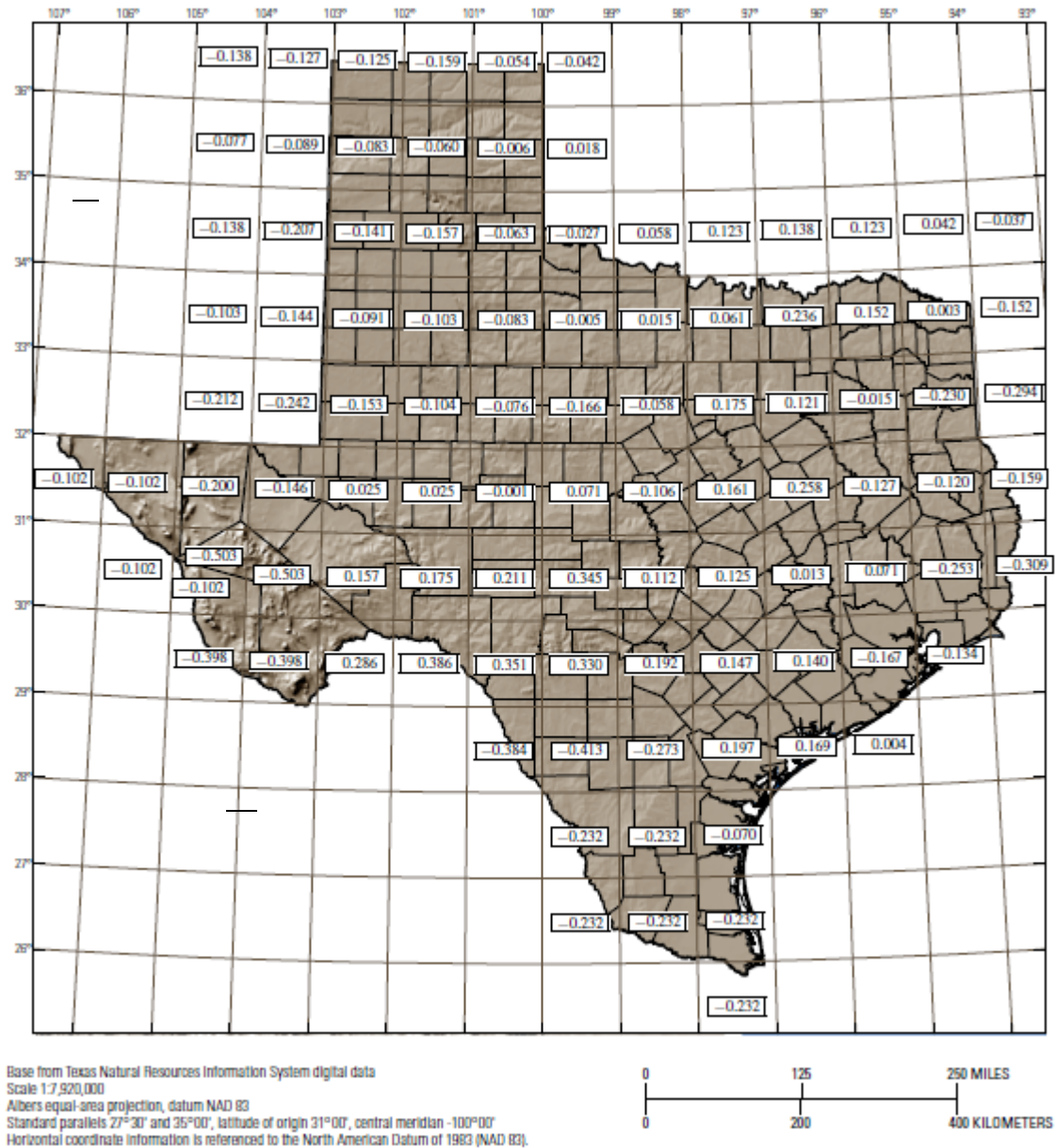

Figure 4-5. OmegaEM (Ω) quadrangles for Texas regression equations. To view a .pdf of this image, click [here](#).

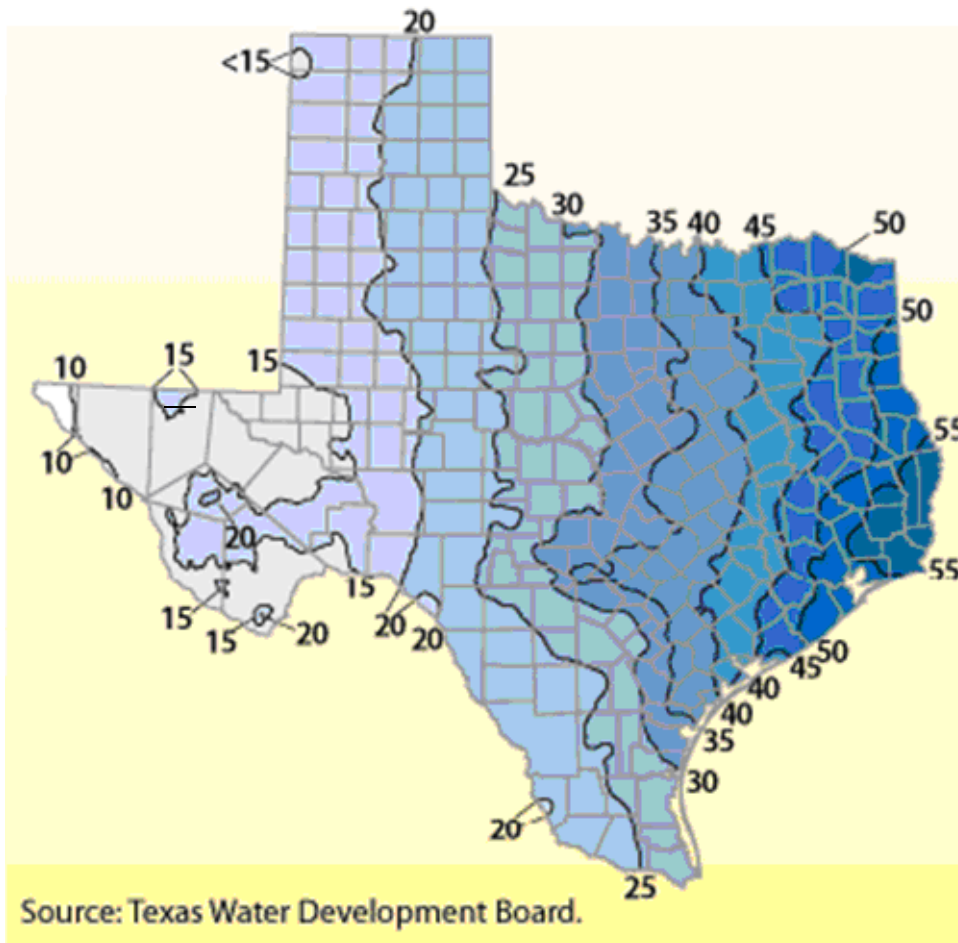

Figure 4-6. Mean annual precipitation, in inches

Equation 4-12 is the general form of the Omega EM regression equation for Texas:

$$Q_T = P^c S^d \times 10^{[e\Omega + a + bA^l]}$$

Equation 4-12.

Where:

Q_T = peak discharge of recurrence interval T years (cfs)

P = mean annual precipitation in inches from Figure 4-6

S = dimensionless main channel slope

Ω = OmegaEM from Figure 4-5

A = contributing drainage area (mi^2)

l = a power determined by iterative PRESS-minimization for the recurrence interval

a, b, c, d, e = regression coefficients specific for the recurrence interval

Mean annual precipitation is the arithmetic mean of a suitably long period of time of total annual precipitation in inches. The mean annual precipitation was assigned based on the approximate center of the watersheds. Asquith and Roussel (2009 TxDOT 0-5521-1) considers that any general and authoritative source of mean annual precipitation for any suitably long period (perhaps 30 years) is sufficient for substitution into the regression equations.

Main channel length is defined as the length in stream-course miles of the longest defined channel from the approximate watershed headwaters to the outlet. Main channel slope is defined as the change in elevation, in feet, between the two end points of the main channel divided by the main channel length in feet.

OmegaEM (Ω) parameter represents a generalized terrain and climate index that expresses relative differences in peak-streamflow potential not represented in the watershed characteristics of drainage area, slope, and mean annual precipitation.

Since the gauges used to develop the equations are points in space, and that the variables used (contributing area, slope, precipitation) are actually attributes of that specific point, the OmegaEM should also pertain to the point in question. As such, if the contributing drainage area overlaps more than one quadrant on Figure 4-5, the OmegaEM must not be weighted or averaged. The OmegaEM specific for the quadrant of the site must be selected.

The summary of weighted-least-squares, PRESS-minimized, regional regression equations using drainage area, dimensionless main-channel slope, mean annual precipitation, and OmegaEM are provided in Table 4-4.

RSE, residual standard error in \log_{10} units of cubic feet per second; Adj., adjusted; AIC, Akaike Information Criterion; PRESS, PRediction Error Sum of Squares.

Table 4-4: Regression Equations

Regression Equations	RSE	Adj. R-squared	AIC statistic	PRESS statistic
$Q_2 = P^{1.398} S^{0.270} \times 10^{[0.776\Omega + 50.98 - 50.30A^{-0.0058}]}$	0.29	0.84	273	64.6
$Q_5 = P^{1.308} S^{0.372} \times 10^{[0.885\Omega + 16.62 - 15.32A^{-0.0215}]}$	0.26	0.88	122	49.1
$Q_{10} = P^{1.203} S^{0.403} \times 10^{[0.918\Omega + 13.62 - 11.97A^{-0.0289}]}$	0.25	0.89	86.5	46.6
$Q_{25} = P^{1.140} S^{0.446} \times 10^{[0.945\Omega + 11.79 - 9.819A^{-0.0374}]}$	0.26	0.89	140	49.5
$Q_{50} = P^{1.105} S^{0.476} \times 10^{[0.961\Omega + 11.17 - 8.997A^{-0.0424}]}$	0.28	0.87	220	55.6

Table 4-4: Regression Equations

Regression Equations	RSE	Adj. R-squared	AIC statistic	PRESS statistic
$Q_{100} = P^{1.071} S^{0.507} \times 10^{[0.969\Omega + 10.82 - 8.448A^{-0.0467}]}$	0.30	0.86	320	64.8
$Q_{500} = P^{0.988} S^{0.569} \times 10^{[0.976\Omega + 10.40 - 7.605A^{-0.0554}]}$	0.37	0.81	591	98.7

Section 11 — Time of Concentration

Time of concentration (t_c) is the time required for the entire watershed to contribute to runoff at the point of interest for hydraulic design; this is calculated as the time for runoff to flow from the most hydraulically remote point of the drainage area to the point under investigation. There may be a number of possible paths to consider in determining the longest travel time. The designer must identify the flow path along which the longest travel time is likely to occur.

When runoff is computed using the [rational method](#), t_c is the appropriate storm duration and in turn determines the appropriate precipitation intensity for use in the [rational method equation](#).

When runoff is computed using the [hydrograph method](#), t_c is used to compute rainfall-runoff parameters for the watershed. t_c is also used as an input to define the appropriate storm duration.

When applicable, the [Kerby-Kirpich method](#) (Roussel et al. 2005) is to be used for estimating t_c . [The National Resources Conservation Service \(1986\) method](#) is also commonly used. Both of these methods estimate t_c as the sum of travel times for discrete flow regimes.

Kerby-Kirpich Method

Roussel et al. 2005 conclude that, in general, Kirpich-inclusive approaches, [and particularly] the Kerby-Kirpich approach, for estimating watershed time of concentration are preferable. The Kerby-Kirpich approach requires comparatively few input parameters, is straightforward to apply, and produces readily interpretable results. The Kerby-Kirpich approach produces time of concentration estimates consistent with watershed time values independently derived from real-world storms and runoff hydrographs. Similar to other methods for calculation of t_c , the total time of concentration is obtained by adding the overland flow time (Kerby) and the channel flow time (Kirpich):

$$t_c = t_{ov} + t_{ch}$$

Equation 4-13.

Where:

t_{ov} = overland flow time

t_{ch} = channel flow time

The Kerby-Kirpich method for estimating t_c is applicable to watersheds ranging from 0.25 square miles to 150 square miles, main channel lengths between 1 and 50 miles, and main channel slopes between 0.002 and 0.02 (ft/ft) (Roussel et al. 2005).

Main channel slope is computed as the change in elevation from the watershed divide to the watershed outlet divided by the curvilinear distance of the main channel (primary flow path) between the watershed divide and the outlet.

No watersheds with low topographic slopes are available in the underlying database. Therefore, the guidance described here is not applicable to watersheds with limited topographic slope. Such watersheds are predominant in the High Plains and Coastal Regions of Texas.

The Kerby Method

For small watersheds where overland flow is an important component of overall travel time, the Kerby method can be used. The Kerby equation is

$$t_{ov} = K(L \times N)^{0.467} S^{-0.235}$$

Equation 4-14.

Where:

t_{ov} = overland flow time of concentration, in minutes

K = a units conversion coefficient, in which $K = 0.828$ for traditional units and $K = 1.44$ for *SI* units

L = the overland-flow length, in feet or meters as dictated by K

N = a dimensionless retardance coefficient

S = the dimensionless slope of terrain conveying the overland flow

In the development of the Kerby equation, the length of overland flow was as much as about 1,200 feet (366 meters). Hence, this length is considered an upper limit and shorter values in practice generally are expected. The dimensionless retardance coefficient used is similar in concept to the well-known [Manning's roughness coefficient](#); however, for a given type of surface, the retardance coefficient for overland flow will be considerably larger than for open-channel flow. Typical values for the retardance coefficient are listed in Table 4-5.

Table 4-5: Kerby Equation Retardance Coefficient Values

Generalized terrain description	Dimensionless retardance coefficient (N)
Pavement	0.02
Smooth, bare, packed soil	0.10
Poor grass, cultivated row crops, or moderately rough packed surfaces	0.20
Pasture, average grass	0.40
Deciduous forest	0.60

Table 4-5: Kerby Equation Retardance Coefficient Values

Generalized terrain description	Dimensionless retardance coefficient (N)
Dense grass, coniferous forest, or deciduous forest with deep litter	0.80

The Kirpich Method

For channel-flow component of runoff, the Kirpich equation is:

$$t_{ov} = K(L \times N)^{0.467} S^{-0.235}$$

Equation 4-15.

Where:

t_{ch} = the time of concentration, in minutes

K = a units conversion coefficient, in which $K = 0.0078$ for traditional units and $K = 0.0195$ for *SI* units

L = the channel flow length, in feet or meters as dictated by K

S = the dimensionless main-channel slope

Application of the Kerby-Kirpich Method

An example (shown below) illustrating application of the Kerby-Kirpich method is informative. For example, suppose a hydraulic design is needed to convey runoff from a small watershed with a drainage area of 0.5 square miles. On the basis of field examination and topographic maps, the length of the main channel from the watershed outlet (the design point) to the watershed divide is 5,280 feet. Elevation of the watershed at the outlet is 700 feet. From a topographic map, elevation along the main channel at the watershed divide is estimated to be 750 feet. The analyst assumes that overland flow will have an appreciable contribution to the time of concentration for the watershed. The analyst estimates that the length of overland flow is about 500 feet and that the slope for the overland-flow component is 2 percent ($S = 0.02$). The area representing overland flow is average grass ($N = 0.40$). For the overland-flow t_c , the analyst applies the Kerby equation,

$$t_{ov} = 0.828(500 \times 0.40)^{0.467} (0.02)^{-0.235}$$

from which t_{ov} is about 25 minutes. For the channel t_{ch} , the analyst applies the Kirpich equation, but first dimensionless main-channel slope is required,

$$S = \frac{750 - 700}{5,280} = 0.0095$$

or about 1 percent. The value for slope and the channel length are used in the Kirpich equation,

$$t_{ch} = 0.0078(5,280 - 500)^{0.770} (0.0095)^{-0.385}$$

from which t_{ch} is about 32 minutes. Because the overland flow t_{ov} is used for this watershed, the subtraction of the overland flow length from the overall main-channel length (watershed divide to outlet) is necessary and reflected in the calculation. Adding the overland flow and channel flow components of gives a watershed of about 57 minutes. Finally, as a quick check, the analyst can evaluate the t_c by using an ad hoc method representing t_c , in hours, as the square root of drainage area, in square miles. For the example, the square root of the drainage area yields a t_c estimate of about 0.71 hours or about 42 minutes, which is reasonably close to 57 minutes. However, 57 minutes is preferable. This example is shown in Figure 4-7.

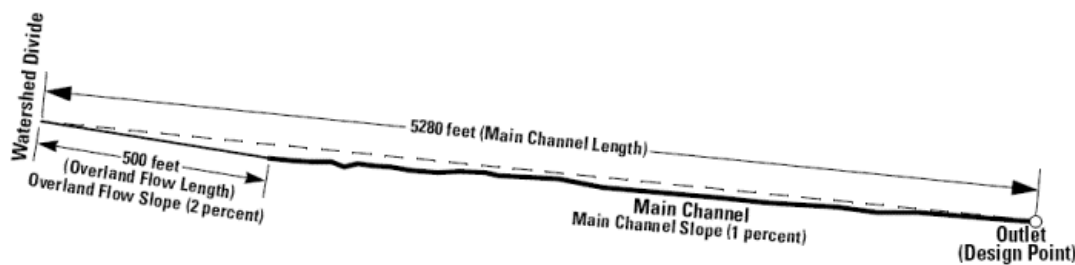

Figure 4-7. Example application of Kerby-Kirpich method

Natural Resources Conservation Service (NRCS) Method for Estimating t_c

The [NRCS](#) method for estimating t_c is applicable for small watersheds, in which the majority of flow is overland flow such that timing of the peak flow is not significantly affected by the contribution flow routed through underground storm drain systems. With the NRCS method:

$$t_c = t_{sh} + t_{sc} + t_{ch}$$

Equation 4-16.

Where:

t_{sh} = sheet flow travel time

t_{sc} = shallow concentrated flow travel time

t_{ch} = channel flow travel time

NRCS 1986 provides the following descriptions of these flow components:

Sheet flow is flow over plane surfaces, usually occurring in the headwater of streams. With sheet flow, the friction value is an effective roughness coefficient that includes the effect of raindrop impact; drag over the plane surface; obstacles such as litter, crop ridges, and rocks; and erosion and transportation of sediment.

After a maximum of 300 ft, sheet flow usually becomes shallow concentrated flow.

Open channels are assumed to begin where surveyed cross section information has been obtained, where channels are visible on aerial photographs, or where blue lines (indicating streams) appear on [USGS](#) quadrangle sheets.

For open channel flow, consider the uniform flow velocity based on bank-full flow conditions. That is, the main channel is flowing full without flow in the overbanks. This assumption avoids the significant iteration associated with rainfall intensity or discharges (because rainfall intensity and discharge are dependent on time of concentration).

For conduit flow, in a proposed storm drain system, compute the velocity at uniform depth based on the computed discharge at the upstream. Otherwise, if the conduit is in existence, determine full capacity flow in the conduit, and determine the velocity at capacity flow. You may need to compare this velocity later with the velocity calculated during conduit analysis. If there is a significant difference and the conduit is a relatively large component of the total travel path, recompute the time of concentration using the latter velocity estimate.

Sheet Flow Time Calculation

Sheet flow travel time is computed as:

$$t_{sh} = \frac{0.007(n_{ol}L_{sh})^{0.8}}{(P_2)^{0.5}S_{sh}^{0.4}}$$

Equation 4-17.

Where:

t_{sh} = sheet flow travel time (hr.)

n_{ol} = overland flow roughness coefficient (provided in Table 4-6)

L_{sh} = sheet flow length (ft) (300 ft. maximum)

P_2 = 2-year, 24-h rainfall depth (in.) (provided in the TxDOT 5-1301-01-1)

S_{sh} = sheet flow slope (ft/ft)

Table 4-6: Overland Flow Roughness Coefficients for Use in NRCS Method in Calculating Sheet Flow Travel Time (Not Manning's Roughness Coefficient) (NRCS 1986)

Surface description		n_{ol}
Smooth surfaces (concrete, asphalt, gravel, or bare soil)		0.011
Fallow (no residue)		0.05
Cultivated soils:	Residue <i>cover</i> ≤ 20 %	0.06
	Residue cover > 20%	0.17
Grass:	Short grass prairie	0.15
	Dense grasses	0.24
	Bermuda	0.41
Range (natural):		0.13
Woods:	Light underbrush	0.40
	Dense underbrush	0.80

Shallow Concentrated Flow

Shallow concentrated flow travel time is computed as:

$$t_{sc} = \frac{L_{sc}}{3600KS_{sc}^{0.5}}$$

Equation 4-18.

Where:

t_{sc} = shallow concentrated flow time (hr.)

L_{sc} = shallow concentrated flow length (ft)

K = 16.13 for unpaved surface, 20.32 for paved surface

S_{sc} = shallow concentrated flow slope (ft/ft)

Channel Flow

Channel flow travel time is computed by dividing the channel distance by the flow rate obtained from Manning's equation. This can be written as:

$$t_{ch} = L_{ch} / \left(\left(3600 \frac{1.49}{n} R^{\frac{2}{3}} S_{ch}^{\frac{1}{2}} \right) \right)$$

Equation 4-19.

Where:

t_{ch} = channel flow time (hr.)

L_{ch} = channel flow length (ft)

S_{ch} = channel flow slope (ft/ft)

n = Manning's roughness coefficient $\frac{a}{P_w}$

R = channel hydraulic radius (ft), and is equal to $\frac{a}{P_w}$, where: a = cross sectional area (ft²) and P_w = wetted perimeter (ft), consider the uniform flow velocity based on bank-full flow conditions. That is, the main channel is flowing full without flow in the over-banks. This assumption avoids the significant iteration associated with other methods that employ rainfall intensity or discharges (because rainfall intensity and discharge are dependent on time of concentration).

Manning's Roughness Coefficient Values

Manning's roughness coefficients are used to calculate flows using Manning's equation. Values from [American Society of Civil Engineers](#) (ASCE) 1992, [FHWA](#) 2001, and Chow 1959 are reproduced in Table 4-7, Table 4-8, and Table 4-9.

Table 4-7: Manning's Roughness Coefficients for Open Channels

Type of channel	Manning's n
A. Natural streams	
1. Minor streams (top width at flood stage < 100 ft)	
a. Clean, straight, full, no rifts or deep pools	0.025-0.033
b. Same as a, but more stones and weeds	0.030-0.040
c. Clean, winding, some pools and shoals	0.033-0.045
d. Same as c, but some weeds and stones	0.035-0.050
e. Same as d, lower stages, more ineffective	0.040-0.055
f. Same as d, more stones	0.045-0.060
g. Sluggish reaches, weedy, deep pools	0.050-0.080
h. Very weedy, heavy stand of timber and underbrush	0.075-0.150
i. Mountain streams with gravel and cobbles, few boulders on bottom	0.030-0.050
j. Mountain streams with cobbles and large boulders on bottom	0.040-0.070
2. Floodplains	
a. Pasture, no brush, short grass	0.025-0.035
b. Pasture, no brush, high grass	0.030-0.050

Table 4-7: Manning's Roughness Coefficients for Open Channels

Type of channel	Manning's n
c. Cultivated areas, no crop	0.020-0.040
d. Cultivated areas, mature row crops	0.025-0.045
e. Cultivated areas, mature field crops	0.030-0.050
f. Scattered brush, heavy weeds	0.035-0.070
g. Light brush and trees in winter	0.035-0.060
h. Light brush and trees in summer	0.040-0.080
i. Medium to dense brush in winter	0.045-0.110
j. Medium to dense brush in summer	0.070-0.160
k. Trees, dense willows summer, straight	0.110-0.200
l. Trees, cleared land with tree stumps, no sprouts	0.030-0.050
m. Trees, cleared land with tree stumps, with sprouts	0.050-0.080
n. Trees, heavy stand of timber, few down trees, flood stage below branches	0.080-0.120
o. Trees, heavy stand of timber, few down trees, flood stage reaching branches	0.100-0.160
3. Major streams (top width at flood stage > 100 ft)	
a. Regular section with no boulders or brush	0.025-0.060
b. Irregular rough section	0.035-0.100
B. Excavated or dredged channels	
1. Earth, straight and uniform	
a. Clean, recently completed	0.016-0.020
b. Clean, after weathering	0.018-0.025
c. Gravel, uniform section, clean	0.022-0.030
d. With short grass, few weeds	0.022-0.033
2. Earth, winding and sluggish	
a. No vegetation	0.023-0.030
b. Grass, some weeds	0.025-0.033
c. Deep weeds or aquatic plants in deep channels	0.030-0.040
d. Earth bottom and rubble sides	0.028-0.035
e. Stony bottom and weedy banks	0.025-0.040
f. Cobble bottom and clean sides	0.030-0.050

Table 4-7: Manning's Roughness Coefficients for Open Channels

Type of channel	Manning's n
g. Winding, sluggish, stony bottom, weedy banks	0.025-0.040
h. Dense weeds as high as flow depth	0.050-0.120
3. Dragline-excavated or dredged	
a. No vegetation	0.025-0.033
b. Light brush on banks	0.035-0.060
4. Rock cuts	
a. Smooth and uniform	0.025-0.040
b. Jagged and irregular	0.035-0.050
5. Unmaintained channels	
a. Dense weeds, high as flow depth	0.050-0.120
b. Clean bottom, brush on sides	0.040-0.080
c. Clean bottom, brush on sides, highest stage	0.045-0.110
d. Dense brush, high stage	0.080-0.140
C. Lined channels	
1. Asphalt	0.013-0.016
2. Brick (in cement mortar)	0.012-0.018
3. Concrete	
a. Trowel finish	0.011-0.015
b. Float finish	0.013-0.016
c. Unfinished	0.014-0.020
d. Gunite, regular	0.016-0.023
e. Gunite, wavy	0.018-0.025
4. Riprap (n-value depends on rock size)	0.020-0.035
5. Vegetal lining	0.030-0.500

Table 4-8: Manning's Coefficients for Streets and Gutters

Type of gutter or pavement	Manning's n
Concrete gutter, troweled finish	0.012
Asphalt pavement: smooth texture	0.013
Asphalt pavement: rough texture	0.016

Table 4-8: Manning's Coefficients for Streets and Gutters

Type of gutter or pavement	Manning's n
Concrete gutter with asphalt pavement: smooth texture	0.013
Concrete gutter with asphalt pavement: rough texture	0.015
Concrete pavement: float finish	0.014
Concrete pavement: broom finish	0.016
Table 4-8 note: For gutters with small slope or where sediment may accumulate, increase n values by 0.02 (USDOT, FHWA 2001).	

Table 4-9: Manning's Roughness Coefficients for Closed Conduits (ASCE 1982, FHWA 2001)

Material	Manning's n
Asbestos-cement pipe	0.011-0.015
Brick	0.013-0.017
Cast iron pipe	
Cement-lined & seal coated	0.011-0.015
Concrete (monolithic)	
Smooth forms	0.012-0.014
Rough forms	0.015-0.017
Concrete pipe	0.011-0.015
Box (smooth)	0.012-0.015
Corrugated-metal pipe -- (2-1/2 in. x 1/2 in. corrugations)	
Plain	0.022-0.026
Paved invert	0.018-0.022
Spun asphalt lined	0.011-0.015
Plastic pipe (smooth)	0.011-0.015
Corrugated-metal pipe -- (2-2/3 in. by 1/2 in. annular)	0.022-0.027
Corrugated-metal pipe -- (2-2/3 in. by 1/2 in. helical)	0.011-0.023
Corrugated-metal pipe -- (6 in. by 1 in. helical)	0.022-0.025
Corrugated-metal pipe -- (5 in. by 1 in. helical)	0.025-0.026
Corrugated-metal pipe -- (3 in. by 1 in. helical)	0.027-0.028
Corrugated-metal pipe -- (6 in. by 2 in. structural plate)	0.033-0.035
Corrugated-metal pipe -- (9 in. by 2-1/2 in. structural plate)	0.033-0.037
Corrugated polyethylene	0.010-0.013
Smooth	0.009-0.015
Corrugated	0.018-0.025
Spiral rib metal pipe (smooth)	0.012-0.013

Table 4-9: Manning's Roughness Coefficients for Closed Conduits (ASCE 1982, FHWA 2001)

Material		Manning's n
Vitrified clay		
	Pipes	0.011-0.015
	Liner plates	0.013-0.017
Polyvinyl chloride (PVC) (smooth)		0.009-0.011
Table 4-9 note: Manning's n for corrugated pipes is a function of the corrugation size, pipe size, and whether the corrugations are annular or helical (see USGS 1993).		

Section 12 — Rational Method

The rational method is appropriate for estimating peak discharges for small drainage areas of up to about 200 acres (80 hectares) with no significant flood storage. The method provides the designer with a peak discharge value, but does not provide a time series of flow nor flow volume.

Assumptions and Limitations

Use of the rational method includes the following assumptions and limitations:

- ◆ The method is applicable if t_c for the drainage area is less than the duration of peak rainfall intensity.
- ◆ The calculated runoff is directly proportional to the rainfall intensity.
- ◆ Rainfall intensity is uniform throughout the duration of the storm.
- ◆ The frequency of occurrence for the peak discharge is the same as the frequency of the rainfall producing that event.
- ◆ Rainfall is distributed uniformly over the drainage area.
- ◆ The minimum duration to be used for computation of rainfall intensity is 10 minutes. If the time of concentration computed for the drainage area is less than 10 minutes, then 10 minutes should be adopted for rainfall intensity computations.
- ◆ The rational method does not account for storage in the drainage area. Available storage is assumed to be filled.

The above assumptions and limitations are the reason the rational method is limited to watersheds 200 acres or smaller. If any one of these conditions is not true for the watershed of interest, the designer should use an alternative method.

The rational method represents a steady inflow-outflow condition of the watershed during the peak intensity of the design storm. Any storage features having sufficient volume that they do not completely fill and reach a steady inflow-outflow condition during the duration of the design storm cannot be properly represented with the rational method. Such features include detention ponds, channels with significant volume, and floodplain storage. When these features are present, an alternate rainfall-runoff method is required that accounts for the time-varying nature of the design storm and/or filling/emptying of floodplain storage. In these cases, the [hydrograph method](#) is recommended.

The steps in developing and applying the rational method are illustrated in Figure 4-8.

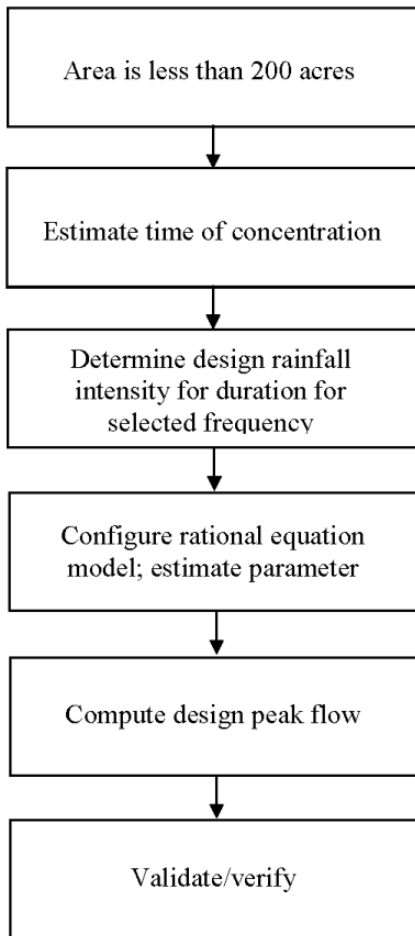

Figure 4-8. Steps in developing and applying the rational method

Procedure for using the Rational Method

The rational formula estimates the peak rate of runoff at a specific location in a watershed as a function of the drainage area, runoff coefficient, and mean rainfall intensity for a duration equal to the time of concentration. The rational formula is:

$$Q = \frac{CIA}{Z}$$

Equation 4-20.

Where:

Q = maximum rate of runoff (cfs or m³/sec.)

C = runoff coefficient

I = average rainfall intensity (in./hr. or mm/hr.)

A = drainage area (ac or ha)

Z = conversion factor, 1 for English, 360 for metric

Rainfall Intensity

With the drainage area A and design AEP known, the designer will determine appropriate values of I and C for use in Equation 4-20. I is given by:

$$I = \frac{P_d}{t_c}$$

Equation 4-21.

Where:

P_d = Depth of rainfall (in. or mm) for AEP design storm of duration t_c

t_c = drainage area time of concentration (hr.)

Values of P_d for use in Equation 4-19 are found in the [Atlas of Depth-Duration Frequency \(DDF\) of Precipitation Annual Maxima for Texas](#) (TxDOT 5-1301-01-1). The atlas includes 96 maps depicting the spatial variation of the DDF of precipitation annual maxima for Texas. The AEPs represented are 50%, 20%, 10%, 4%, 2%, 1%, 0.4%, and 0.2% (2-, 5-, 10-, 25-, 50-, 100-, 250-, and 500-years). The storm durations represented are 15 and 30 minutes; 1, 2, 3, 6, and 12 hours; and 1, 2, 3, 5, and 7 days.

In most cases, the computed value of t_c will not exactly match the durations provided in the atlas, i.e. $t_c = 4$ hours. In these cases, the designer can obtain the depth for the desired duration by performing a log-log interpolation between depth-duration pairs provided in the atlas. This process is illustrated in Figure 4-16.

Runoff Coefficients

Urban Watersheds

Table 4-10 suggests ranges of C values for urban watersheds for various combinations of land use and soil/surface type. This table is typical of design guides found in civil engineering texts dealing with hydrology.

Table 4-10: Runoff Coefficients for Urban Watersheds

Type of drainage area	Runoff coefficient
Business:	
Downtown areas	0.70-0.95
Neighborhood areas	0.30-0.70
Residential:	
Single-family areas	0.30-0.50
Multi-units, detached	0.40-0.60
Multi-units, attached	0.60-0.75
Suburban	0.35-0.40
Apartment dwelling areas	0.30-0.70
Industrial:	
Light areas	0.30-0.80
Heavy areas	0.60-0.90
Parks, cemeteries	0.10-0.25
Playgrounds	0.30-0.40
Railroad yards	0.30-0.40
Unimproved areas:	
Sand or sandy loam soil, 0-3%	0.15-0.20
Sand or sandy loam soil, 3-5%	0.20-0.25
Black or loessial soil, 0-3%	0.18-0.25
Black or loessial soil, 3-5%	0.25-0.30
Black or loessial soil, > 5%	0.70-0.80
Deep sand area	0.05-0.15
Steep grassed slopes	0.70
Lawns:	
Sandy soil, flat 2%	0.05-0.10
Sandy soil, average 2-7%	0.10-0.15
Sandy soil, steep 7%	0.15-0.20
Heavy soil, flat 2%	0.13-0.17
Heavy soil, average 2-7%	0.18-0.22

Table 4-10: Runoff Coefficients for Urban Watersheds

Type of drainage area	Runoff coefficient
Heavy soil, steep 7%	0.25-0.35
Streets:	
Asphaltic	0.85-0.95
Concrete	0.90-0.95
Brick	0.70-0.85
Drives and walks	0.75-0.95
Roofs	0.75-0.95

Rural and Mixed-Use Watershed

Table 4-11 shows an alternate, systematic approach for developing the runoff coefficient. This table applies to rural watersheds only, addressing the watershed as a series of aspects. For each of four aspects, the designer makes a systematic assignment of a runoff coefficient “component.” Using Equation 4-22, the four assigned components are added to form an overall runoff coefficient for the specific watershed segment.

The runoff coefficient for rural watersheds is given by:

$$C = C_r + C_i + C_v + C_s$$

Equation 4-22.

Where:

C = runoff coefficient for rural watershed

C_r = component of coefficient accounting for watershed relief

C_i = component of coefficient accounting for soil infiltration

C_v = component of coefficient accounting for vegetal cover

C_s = component of coefficient accounting for surface type

The designer selects the most appropriate values for C_r , C_i , C_v , and C_s from Table 4-11.

Table 4-11: Runoff Coefficients for Rural Watersheds

Watershed characteristic	Extreme	High	Normal	Low
Relief - C_r	0.28-0.35 Steep, rugged terrain with average slopes above 30%	0.20-0.28 Hilly, with average slopes of 10-30%	0.14-0.20 Rolling, with average slopes of 5-10%	0.08-0.14 Relatively flat land, with average slopes of 0-5%
Soil infiltration - C_i	0.12-0.16 No effective soil cover; either rock or thin soil mantle of negligible infiltration capacity	0.08-0.12 Slow to take up water, clay or shallow loam soils of low infiltration capacity or poorly drained	0.06-0.08 Normal; well drained light or medium textured soils, sandy loams	0.04-0.06 Deep sand or other soil that takes up water readily; very light, well-drained soils
Vegetal cover - C_v	0.12-0.16 No effective plant cover, bare or very sparse cover	0.08-0.12 Poor to fair; clean cultivation, crops or poor natural cover, less than 20% of drainage area has good cover	0.06-0.08 Fair to good; about 50% of area in good grassland or woodland, not more than 50% of area in cultivated crops	0.04-0.06 Good to excellent; about 90% of drainage area in good grassland, woodland, or equivalent cover
Surface Storage - C_s	0.10-0.12 Negligible; surface depressions few and shallow, drainageways steep and small, no marshes	0.08-0.10 Well-defined system of small drainageways, no ponds or marshes	0.06-0.08 Normal; considerable surface depression, e.g., storage lakes and ponds and marshes	0.04-0.06 Much surface storage, drainage system not sharply defined; large floodplain storage, large number of ponds or marshes
Table 4-11 note: The total runoff coefficient based on the 4 runoff components is $C = C_r + C_i + C_v + C_s$				

While this approach was developed for application to rural watersheds, it can be used as a check against mixed-use runoff coefficients computed using other methods. In so doing, the designer would use judgment, primarily in specifying C_s , to account for partially developed conditions within the watershed.

Mixed Land Use

For areas with a mixture of land uses, a composite runoff coefficient should be used. The composite runoff coefficient is weighted based on the area of each respective land use and can be calculated as:

$$C_w = \frac{\sum_{j=1}^n C_j A_j}{\sum_{j=1}^n A_j}$$

Equation 4-23.

Where:

C_w = weighted runoff coefficient

C_j = runoff coefficient for area j

A_j = area for land cover j (ft²)

n = number of distinct land uses

Section 13 — Hydrograph Method

A hydrograph represents runoff as it varies over time at a particular location within the watershed. The area integrated under the hydrograph represents the volume of runoff.

Estimation of a runoff hydrograph, as opposed to the peak rate of runoff, is necessary for watersheds with complex runoff characteristics. The hydrograph method also should be used when storage must be evaluated, as it accounts explicitly for volume and timing of runoff. The hydrograph method has no drainage area size limitation.

[Figure 4-2](#) shows that in cases for which a statistical distribution cannot be fitted and a regression equation will not predict adequately the design flow, some sort of empirical or conceptual rainfall-runoff model can be used to predict the design flow. Such application is founded on the principle that the [AEP](#) of the computed runoff peak or volume is the same as the AEP of the rainfall used as input to (the boundary condition for) the model.

The hydrograph method is applicable for watersheds in which t_c is longer than the duration of peak rainfall intensity of the design storm. Precipitation applied to the watershed model is uniform spatially, but varies with time. The hydrograph method accounts for losses (soil infiltration for example) and transforms the remaining (excess) rainfall into a runoff hydrograph at the outlet of the watershed. [Figure 4-9](#) shows the different components that must be represented to simulate the complete response of a watershed.

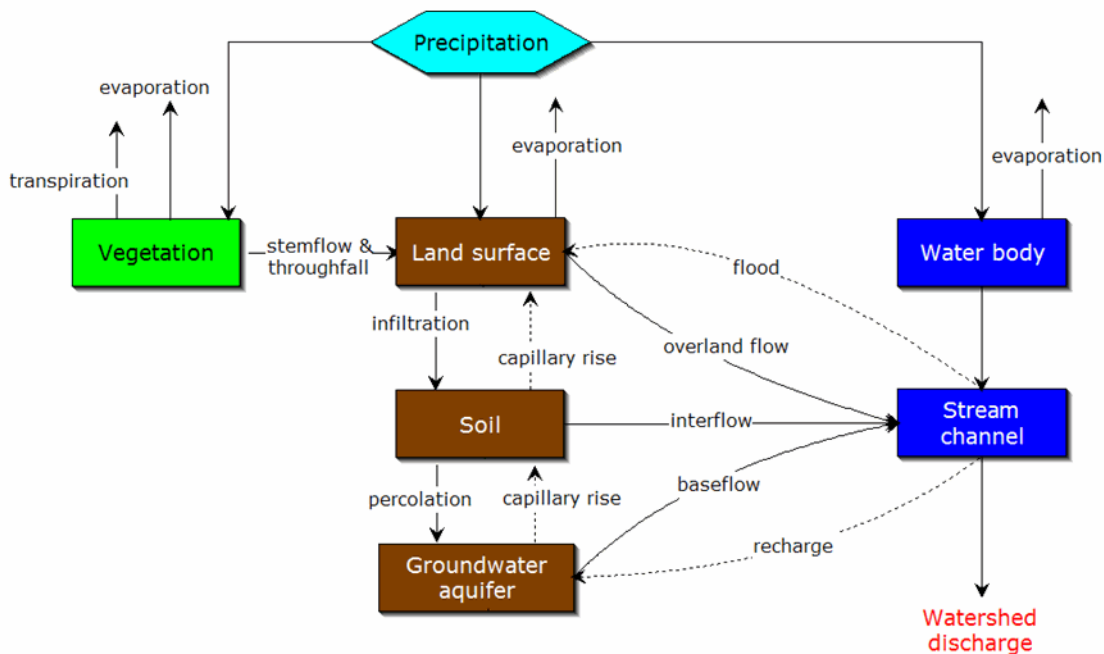

Figure 4-9. Components of the hydrograph method

The method is also applicable to complex watersheds, in which runoff hydrographs for multiple subbasins are computed, then routed to a common point and combined to yield the total runoff hydrograph at that location. Reasons for dividing a large watershed into subbasins include:

- ◆ The subbasins have distinct hydrologic characteristics.
- ◆ Unique storm depths are appropriate for the different subbasin areas.
- ◆ Computed hydrographs are needed at more than one location.

Because the resulting runoff hydrograph is a time series of flow values, the method provides a peak flow value as well as volume of runoff. This makes the method suitable for design problems requiring runoff volume as a design parameter.

Successful application of the hydrograph method requires the designer to:

- ◆ Define the temporal and spatial distribution of the desired [AEP](#) design storm.
- ◆ Specify appropriate loss model parameters to compute the amount of precipitation lost to other processes, such as infiltration, and does not run off the watershed.
- ◆ Specify appropriate parameters to compute runoff hydrograph resulting from excess (not lost) precipitation.
- ◆ If necessary for the application, specify appropriate parameters to compute the lagged and attenuated hydrograph at downstream locations.

Basic steps to developing and applying a rainfall-runoff model for predicting the required design flow are illustrated in Figure 4-10. These steps are described in more detail below.

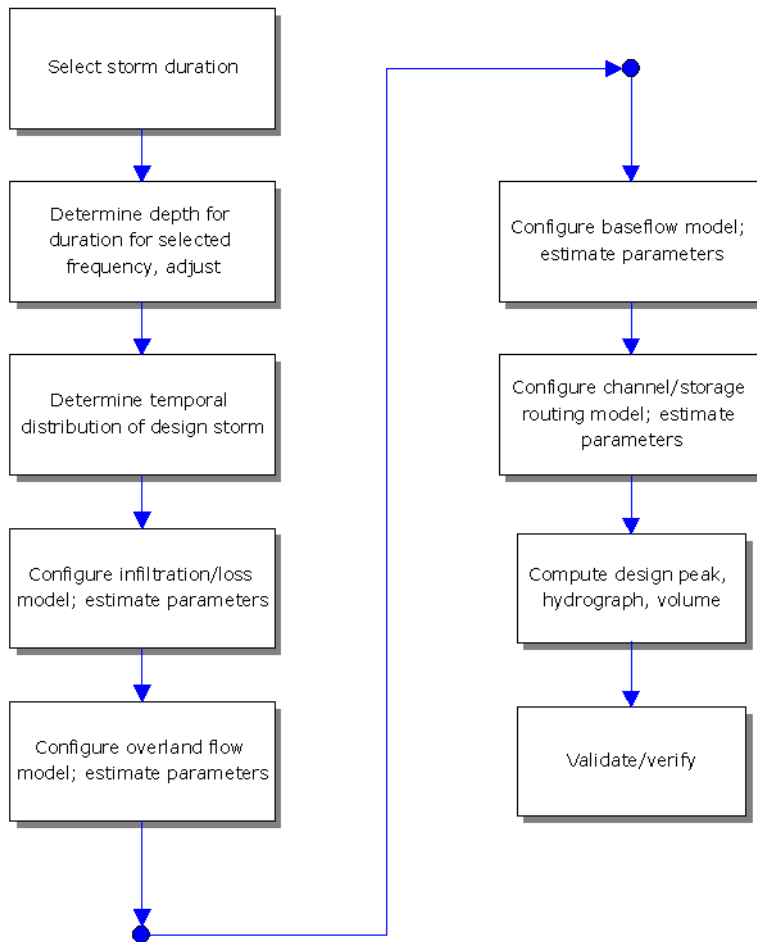

Figure 4-10. Steps in developing and applying the hydrograph method

Design Storm Development

A design storm is a precipitation pattern or intensity value defined for design of drainage facilities. Design storms are either based on historical precipitation data or rainfall characteristics in the project area or region. Application of design storms ranges from point precipitation for calculation of peak flows using the rational method to storm hyetographs as input for rainfall-runoff analysis in the hydrograph method. The fundamental assumption using design storms is that precipitation of an [AEP](#) yields runoff of the same AEP.

Selection of Storm Duration

Selecting storm duration is the first step in design storm modeling. The appropriate storm duration for stormwater runoff calculations is dependent on the drainage area's hydrologic response. The selected storm duration should be sufficiently long that the entire drainage area contributes to discharge at the point of interest. Storm duration is defined in terms of time of concentration (t_c),

which is the time it takes for runoff to travel from the hydraulically most distant point of the watershed to a point of interest within the watershed.

For complete drainage of the area, time for overland flow, channel flow, and storage must be considered. Typically for hydrograph computations the storm duration should be four or five times the [time of concentration](#). Longer duration of storm will not increase the peak discharge substantially, but will contribute greater volume of runoff.

Commonly, a storm duration of 24 hours is used. However the 24-hour storm duration should not be used blindly. Runoff from longer and shorter storms should be computed to demonstrate the sensitivity of the design choices.

For TxDOT, the [NRCS](#) 24-hour storm should be used as a starting point for analysis. However, if the analysis results appear inconsistent with expectations, site performance, or experience, an alternative storm duration should be considered. In that case, the designer should consult the Design Division Hydraulics Branch for advice.

Storm Depth: Depth-Duration-Frequency (DDF) Relationships

Once the storm duration is selected, the next step is to determine the rainfall depth or intensity of that duration for the selected AEP. [Depth-Duration Frequency Precipitation for Texas](#) (Asquith 1998) provides procedures to estimate that depth for any location in Texas. The [Atlas of Depth-Duration Frequency of Precipitation Annual Maxima for Texas](#) (TxDOT 5-1301-01-1) is an extension of the 1998 study and an update of [Technical Paper No. 40: Rainfall Frequency Atlas of the United States](#) (Hershfield 1961), [Technical Paper No. 49: 2- to 10-Day Precipitation for Return Periods of 2 to 100 Year in the Contiguous United States](#) (Miller 1964), and [NOAA NWS Hydro-35: 5 to 60 Minute Precipitation Frequency for the Eastern and Central United States](#) (Frederick et al. 1977).

The Atlas of Depth-Duration Frequency of Precipitation Annual Maxima for Texas includes 96 maps depicting the spatial variation of the DDF of precipitation annual maxima for Texas. The [AEPs](#) represented are 50%, 20%, 10%, 4%, 2%, 1%, 0.4%, and 0.2% (2-, 5-, 10-, 25-, 50-, 100-, 250-, and 500-years). The storm durations represented are 15 and 30 minutes; 1, 2, 3, 6, and 12 hours; and 1, 2, 3, 5, and 7 days.

Intensity-Duration-Frequency Relationships

While hydrograph methods require both rainfall depth and temporal distribution, the rational method requires only intensity. The rainfall intensity (I) is the average rainfall rate in inches/hour for a specific rainfall duration and a selected frequency. For drainage areas in Texas, rainfall intensity may be computed by:

1. Using maps in the Atlas of Depth-Duration Frequency of Precipitation Annual Maxima for Texas publication to obtain the precipitation depth for a given frequency.
2. Converting the precipitation depth to a precipitation intensity by dividing the depth by the storm duration. The precipitation is measured in inches/hour.

For example, if the 100-year, 6-hour depth is 3.2 inches, the precipitation intensity equals $3.2 \text{ inches} / 6 \text{ hours} = 0.53 \text{ inches/hour}$.

Areal Depth Adjustment

When estimating runoff due to a rainfall event, a uniform areal distribution of rainfall over the watershed is assumed. However, for intense storms, uniform rainfall is unlikely. Rather, rainfall varies across the drainage area. To account for this variation, an areal adjustment is made to convert point depths to an average areal depth. For drainage areas smaller than 10 square miles, the areal adjustment is negligible. For larger areas, point rainfall depths and intensities must be adjusted. Two methods are presented here for use in design of drainage facilities: the first is by the US Weather Bureau and the second is by [USGS](#).

US Weather Bureau Areal Depth Adjustment

The US Weather Bureau (1958) developed Figure 4-11 from an annual series of rain gauge networks. It shows the percentage of point depths that should be used to yield average areal depths.

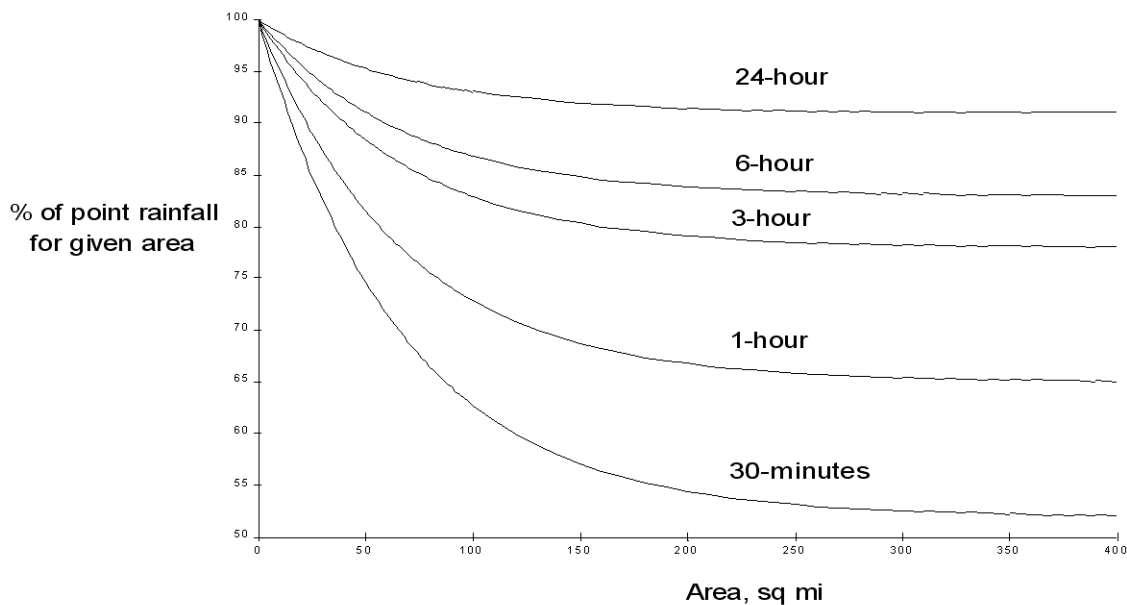

Figure 4-11. Depth area adjustment (US Weather Bureau 1958)

USGS Areal-Reduction Factors for the Precipitation of the 1-Day Design Storm in Texas

Areal reduction factors (ARFs) specific for Texas for a 1-day design storm were developed by Asquith (1999). Asquith's method uses an areal reduction factor that ranges from 0 to 1. The method is a function of watershed characteristics such as size and shape, geographic location, and time of year that the design storm is presumed to occur. The study was based on precipitation monitoring networks in the Austin, Dallas, and Houston areas. If using a 1-day design storm, this is the appropriate method of areal reduction to use for design of highway drainage facilities in Texas.

However, the applicability of this method diminishes the farther away from the Austin, Dallas, or Houston areas the study area is and as the duration of the design storm increasingly differs from that of 1 day. For further information and example problems on calculating the ARF, refer to Asquith (1999).

A relationship exists between the point of an annual precipitation maxima and the distance between both the centroid of the watershed and every location radiating out from the centroid. This is assuming the watershed is or nearly so circular. $ST(r)$ is the expected value of the ratio between the depth at some location a distance r from the point of the design storm. T refers to the frequency of the design storm. Equations for $ST(r)$ for the 50% (2-year) or smaller AEP vary by proximity to Austin, Dallas, and Houston. For an approximately circular watershed, the ARF is calculated with the following equation:

$$ARF = \frac{\int_0^R 2rS_2(r)dr}{R^2}$$

Equation 4-24.

Where:

r = variable of integration ranging from 0 to R

R = radius of the watershed (mi)

$S_2(r)$ = estimated 2-year or greater depth-distance relation (mi)

The site-specific equations for $S_2(r)$ for differing watershed radii are in Table 4-12 at the end of this section.

Once the ARF is calculated, the effective depth of the design storm is found by multiplying the ARF by the point precipitation depth found using [Atlas of Depth-Duration Frequency of Precipitation Annual Maxima for Texas](#).

For example, an approximately circular watershed in the Dallas area is 50.3 square miles ($R = 4$ miles). From Table 4-12:

$$S_2 = 1.0000 - 0.06(r) \text{ for } 0 \leq r \leq 2$$

$$S_2 = 0.9670 - 0.0435(r) \text{ for } 2 \leq r \leq 4$$

Substituting the above expressions into Equation 4-25 gives:

$$ARF = \frac{2}{(4)^2} \left\{ \int_0^2 r[1 - 0.06r]dr + \int_2^4 r[0.9670 - 0.0435r]dr \right\}$$

$$ARF = 0.125 \left\{ \left[\frac{r^2}{2} - \frac{0.06r^3}{3} \right]_0^2 + \left[\frac{0.9670r^2}{2} - \frac{0.0435r^3}{3} \right]_2^4 \right\}$$

$$ARF = 0.125 \left\{ \left[\frac{2^2}{2} - \frac{0.06(2^3)}{3} \right] + \left[\frac{0.9670(4^2 - 2^2)}{2} - \frac{0.0435(4^3 - 2^3)}{3} \right] \right\}$$

$$ARF = 0.125(1.84 + 4.99)$$

$$ARF = 0.85$$

An easier way to determine ARF for circular watersheds is to use the equation from Table 4-12 in column “ARF for circular watersheds having radius r” for the city and radius of interest. For the previous example (City of Dallas, R = 4 miles), the equation would be:

$$ARF = 0.9670 - 0.290(r) + (0.0440/r^2)$$

$$ARF = 0.85$$

From the precipitation atlas, the 1% (100-year) 1-day depth is 9.8 inches. Multiply this depth by 0.85 to obtain the 24-hour 1% [AEP](#) areally reduced storm depth of 8.3 inches.

If the designer finds that a circular approximation of the watershed is inappropriate for the watershed of interest, the following procedure for non-circular watersheds should be used. The procedure for non-circular watersheds is as follows:

1. Represent the watershed as discrete cells; the cells do not have to be the same area.
2. Locate the cell containing the centroid of the watershed.
3. For each cell, calculate the distance to the centroid (r).
4. Using the distances from Step 3, solve the appropriate equations from [Table 4-12](#) for $S_2(r)$ for each cell.
5. Multiply $S_2(r)$ by the corresponding cell area to compute ARF ; the area multiplication simply acts as a weight for a weighted mean.
6. Compute the sum of the cell areas.
7. Compute the sum of the product of $S_2(r)$ and cell area from Step 5.

8. Divide the result of Step 7 by Step 6.

Table 4-12: Equations That Define the Estimated 2-Year or Greater Depth-Distance Relation and the Areal-Reduction Factor for Circular Watersheds

City	Estimated 2-yr or greater depth-distance relation for distance r (mi)	ARF for circular watersheds having radius r (mi)	Equation limits
Austin	$S_2(r) = 1.000 - 0.1400 (r)$	$ARF = 1.000 - 0.0933 (r)$	$0 \leq r \leq 1$
	$S_2(r) = 0.9490 - 0.0890 (r)$	$ARF = 0.9490 - 0.0593 (r) + (0.0170 / r^2)$	$1 \leq r \leq 2$
	$S_2(r) = 0.8410 - 0.0350 (r)$	$ARF = 0.8410 - 0.0233 (r) + (0.1610 / r^2)$	$2 \leq r \leq 3$
	$S_2(r) = 0.8080 - 0.0240 (r)$	$ARF = 0.8080 - 0.0160 (r) + (0.2600 / r^2)$	$3 \leq r \leq 4.5$
	$S_2(r) = 0.7750 - 0.0167 (r)$	$ARF = 0.7750 - 0.0111 (r) + (0.4828 / r^2)$	$4.5 \leq r \leq 9$
	$S_2(r) = 0.7420 - 0.0130 (r)$	$ARF = 0.7420 - 0.0087 (r) + (1.3737 / r^2)$	$9 \leq r \leq 13$
	$S_2(r) = 0.7203 - 0.0113 (r)$	$ARF = 0.7203 - 0.0076 (r) + (2.5943 / r^2)$	$13 \leq r \leq 19$
	$S_2(r) = 0.6950 - 0.0100 (r)$	$ARF = 0.6950 - 0.0067 (r) + (5.6427 / r^2)$	$19 \leq r \leq 28$
	$S_2(r) = 0.6502 - 0.0084 (r)$	$ARF = 0.6502 - 0.0056 (r) + (17.3505 / r^2)$	$28 \leq r \leq 33$
	$S_2(r) = 0.6040 - 0.0070 (r)$	$ARF = 0.6040 - 0.0047 (r) + (34.1211 / r^2)$	$33 \leq r \leq 41$
$S_2(r) = 0.3717 - 0.0013 (r)$	$ARF = 0.3717 - 0.0009 (r) + (164.3052 / r^2)$	$41 \leq r \leq 50$	
Dallas	$S_2(r) = 1.000 - 0.0600 (r)$	$ARF = 1.000 - 0.0400 (r)$	$0 \leq r \leq 2$
	$S_2(r) = 0.9670 - 0.0435 (r)$	$ARF = 0.9670 - 0.0290 (r) + (0.0440 / r^2)$	$2 \leq r \leq 4$
	$S_2(r) = 0.8910 - 0.0245 (r)$	$ARF = 0.8910 - 0.0163 (r) + (0.4493 / r^2)$	$4 \leq r \leq 6$
	$S_2(r) = 0.8760 - 0.0220 (r)$	$ARF = 0.8760 - 0.0147 (r) + (0.6293 / r^2)$	$6 \leq r \leq 8$
	$S_2(r) = 0.8460 - 0.0183 (r)$	$ARF = 0.8460 - 0.0122 (r) + (1.2693 / r^2)$	$8 \leq r \leq 12$
	$S_2(r) = 0.8130 - 0.0155 (r)$	$ARF = 0.8130 - 0.0103 (r) + (2.8533 / r^2)$	$12 \leq r \leq 16$

Table 4-12: Equations That Define the Estimated 2-Year or Greater Depth-Distance Relation and the Areal-Reduction Factor for Circular Watersheds

City	Estimated 2-yr or greater depth-distance relation for distance r (mi)	ARF for circular watersheds having radius r (mi)	Equation limits
	$S_2(r) = 0.7650 - 0.0125 (r)$	$ARF = 0.7650 - 0.0083 (r) + \left(6.9493 / r^2\right)$	$16 \leq r \leq 18$
	$S_2(r) = 0.7200 - 0.0100 (r)$	$ARF = 0.7200 - 0.0067 (r) + \left(11.8093 / r^2\right)$	$18 \leq r \leq 24$
	$S_2(r) = 0.6880 - 0.0087 (r)$	$ARF = 0.6800 - 0.0058 (r) + \left(17.9533 / r^2\right)$	$24 \leq r \leq 27$
	$S_2(r) = 0.6228 - 0.0063 (r)$	$ARF = 0.6228 - 0.0042 (r) + \left(33.8091 / r^2\right)$	$27 \leq r \leq 31$
	$S_2(r) = 0.5563 - 0.0041 (r)$	$ARF = 0.5563 - 0.0027 (r) + \left(55.1070 / r^2\right)$	$31 \leq r \leq 50$
Houston	$S_2(r) = 1.000 - 0.1200 (r)$	$ARF = 1.000 - 0.0800 (r)$	$0 \leq r \leq 1$
	$S_2(r) = 0.9400 - 0.0600 (r)$	$ARF = 0.9400 - 0.0400 (r) + \left(0.0200 / r^2\right)$	$1 \leq r \leq 2$
	$S_2(r) = 0.8800 - 0.0300 (r)$	$ARF = 0.8800 - 0.0200 (r) + \left(0.1000 / r^2\right)$	$2 \leq r \leq 4$
	$S_2(r) = 0.8667 - 0.0267 (r)$	$ARF = 0.8667 - 0.0178 (r) + \left(0.1711 / r^2\right)$	$4 \leq r \leq 7$
	$S_2(r) = 0.8078 - 0.0183 (r)$	$ARF = 0.8708 - 0.0122 (r) + \left(1.1334 / r^2\right)$	$7 \leq r \leq 11$
	$S_2(r) = 0.7363 - 0.0118 (r)$	$ARF = 0.7363 - 0.0078 (r) + \left(4.0173 / r^2\right)$	$11 \leq r \leq 15$
	$S_2(r) = 0.6800 - 0.0080 (r)$	$ARF = 0.6800 - 0.00053 (r) + \left(8.2360 / r^2\right)$	$15 \leq r \leq 20$
	$S_2(r) = 0.6187 - 0.0049 (r)$	$ARF = 0.6187 - 0.0033 (r) + \left(16.4138 / r^2\right)$	$20 \leq r \leq 50$

Rainfall Temporal Distribution

The temporal rainfall distribution is how rainfall intensity varies over time for a single event. The mass rainfall curve, illustrated in Figure 4-12, is the cumulative precipitation up to a specific time. In drainage design, the storm is divided into time increments, and the average depth during each time increment is estimated, resulting in a rainfall hyetograph as shown in Figure 4-13.

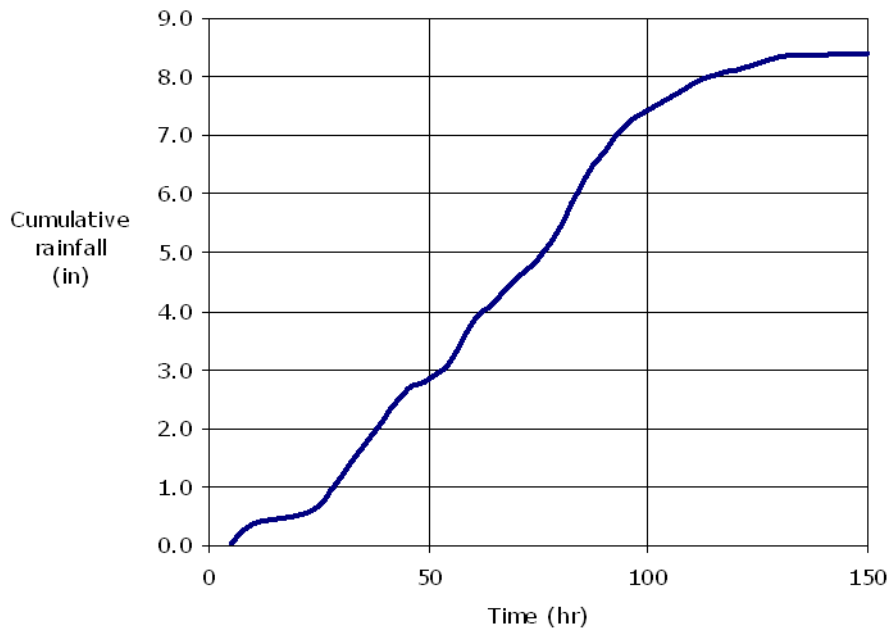

Figure 4-12. Example mass rainfall curve from historical storm

Hyetograph Development Procedure

In the rational method the intensity is considered to be uniform over the storm period. Hydrograph techniques, however, account for variability of the intensity throughout a storm. Therefore, when using hydrograph techniques, the designer must determine a rainfall hyetograph: a temporal distribution of the watershed rainfall, as shown in Figure 4-13.

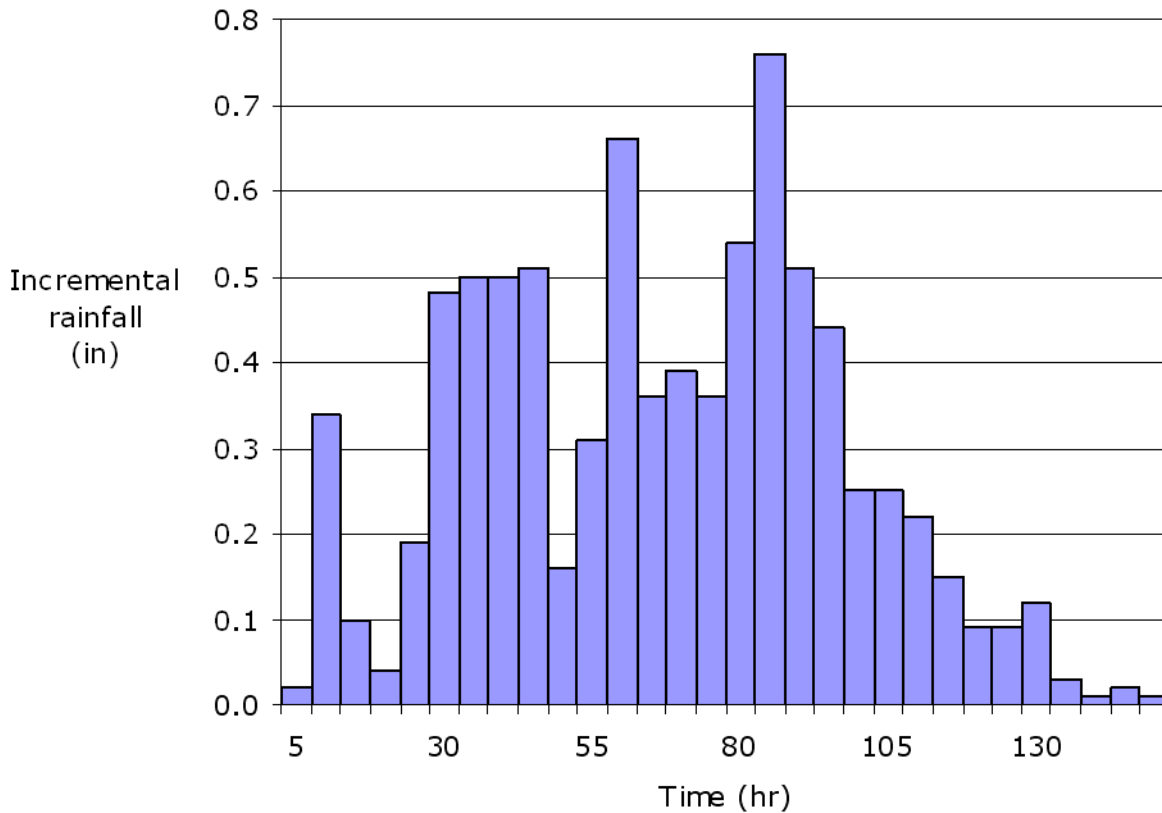

Figure 4-13. Rainfall hyetograph

Methods acceptable for developing a rainfall hyetograph for a design storm include the [NRCS](#) method, the balanced storm method, and the Texas storm method.

NRCS Hyetograph Development Procedure

The NRCS design storm hyetographs were derived by averaging storm patterns for regions of the U.S. The storms thus represent a pattern distribution of rainfall over a 24-hour period to which a design rainfall depth can be applied. The distribution itself is arranged in a critical pattern with the maximum precipitation period occurring just before the midpoint of the storm.

Figure 4-14 and Table 4-13 show the NRCS 24-hour rainfall distributions for Texas: Type II and Type III. Figure 4-15 shows the areas in Texas to which these distribution types apply. The distribution represents the fraction of accumulated rainfall (not runoff) accrued with respect to time.

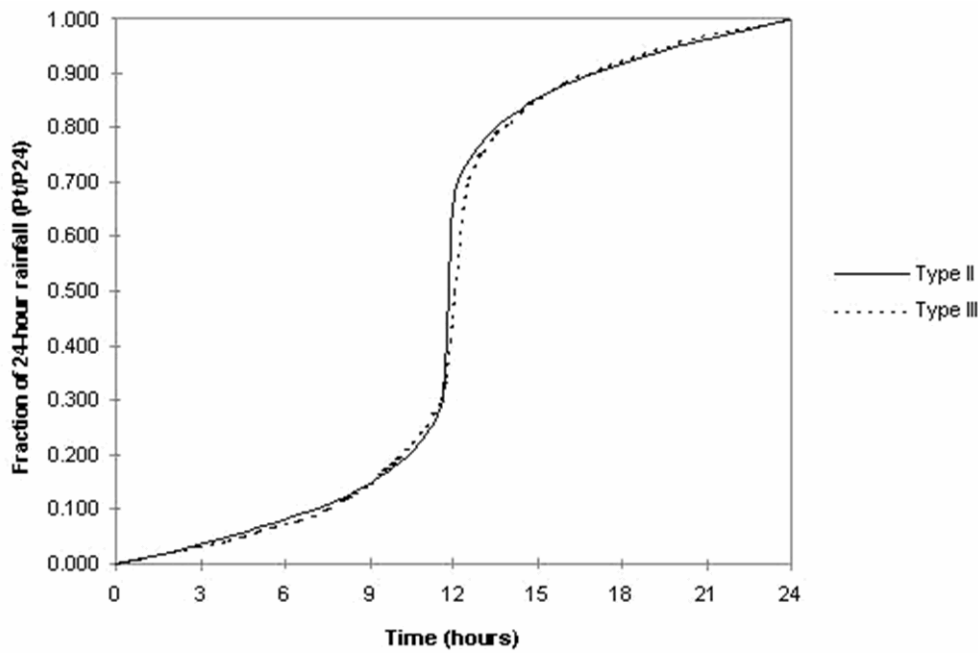

Figure 4-14. NRCS 24-hour rainfall distributions (NRCS 1986)

Table 4-13: NRCS 24-Hour Rainfall Distributions

Time, t (hours)	Fraction of 24-hour rainfall	
	Type II	Type III
0	0.000	0.000
2	0.022	0.020
4	0.048	0.043
6	0.080	0.072
7	0.098	0.089
8	0.120	0.115
8.5	0.133	0.130
9	0.147	0.148
9.5	0.163	0.167
9.75	0.172	0.178
10	0.181	0.189
10.5	0.204	0.216
11	0.235	0.250

Table 4-13: NRCS 24-Hour Rainfall Distributions

Time, t (hours)	Fraction of 24-hour rainfall	
	Type II	Type III
11.5	0.283	0.298
11.75	0.357	0.339
12	0.663	0.500
12.5	0.735	0.702
13	0.772	0.751
13.5	0.799	0.785
14	0.820	0.811
16	0.880	0.886
20	0.952	0.957
24	1.000	1.000

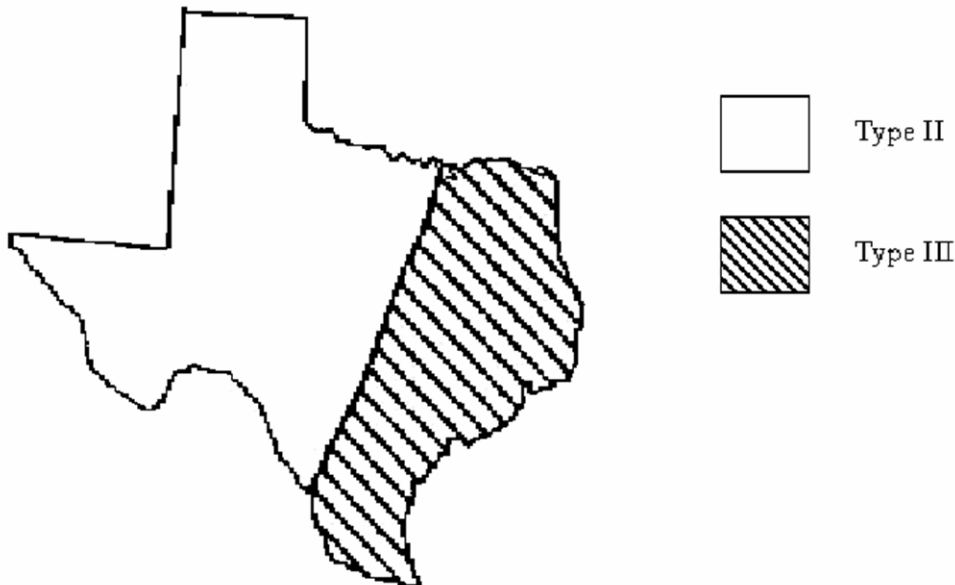

Figure 4-15. Rainfall distribution types in Texas (TR-55 1986)

Use the following steps to develop a rainfall hyetograph:

1. Determine the rainfall depth (P_d) for the desired design frequency and location.
2. Use Figure 4-15 to determine the distribution type.
3. Select an appropriate time increment for computation of runoff hydrograph ordinates. An increment equal $1/5$ or $1/6$ of the time of concentration is adequate for most analyses.

4. Create a table of time and the fraction of rainfall total. Interpolate the rainfall distributions table for the appropriate distribution type.
5. Multiply the cumulative fractions by the total rainfall depth (from step 1) to get the cumulative depths at various times.
6. Determine the incremental rainfall for each time period by subtracting the cumulative rainfall at the previous time step from the current time step.

Balanced Storm Hyetograph Development Procedure

The triangular temporal distribution, with the peak of the storm located at the center of the hyetograph, is also called balanced storm. It uses DDF values that are based on a statistical analysis of historical data. The procedure for deriving a hyetograph with this method is as follows:

1. For the selected [AEP](#), tabulate rainfall amounts for a storm of a given return period for all durations up to a specified limit (for 24-hour, 15-minute, 30-minute, 1-hour, 2-hour, 3-hour, 6-hour, 12-hour, 24-hour, etc.). Use the maps in Asquith 2004, locating the study area on the appropriate map for the duration and AEP selected for design.
2. Select an appropriate time interval. An appropriate time interval is related to the time of concentration of the watershed. To calculate the time interval, use:

$$\Delta t = \frac{1}{5} \text{ or } \frac{1}{6} t_c$$

Equation 4-25.

Where:

Δt = time interval

t_c = time of concentration

For example, if the time of concentration is 1 hour, $\Delta t = 1/5 t_c = 1/5$ of 1 hour = 12 minutes, or $1/6$ of 1 hour = 10 minutes. Choosing $1/5$ or $1/6$ will not make a significant difference in the distribution of the rainfall; use one fraction or the other to determine a convenient time interval.

3. For successive times of interval Δt , find the cumulative rainfall depths from the DDF values. For depths at time intervals not included in the DDF tables, interpolate depths for intermediate durations using a log-log interpolation. (Durations from the table are usually given in hours, but in minutes on the plot.) For example, given a study area in the northern part of Bexar County, the log-log plot in Figure 4-16 shows the 10% depths for the 15-, 30-, 60-, 120-, 180-, 360-, 720-, and 1440-minute durations included in Asquith and Roussel 2004. The precipitation depth at 500 minutes is interpolated as 5.0 inches.

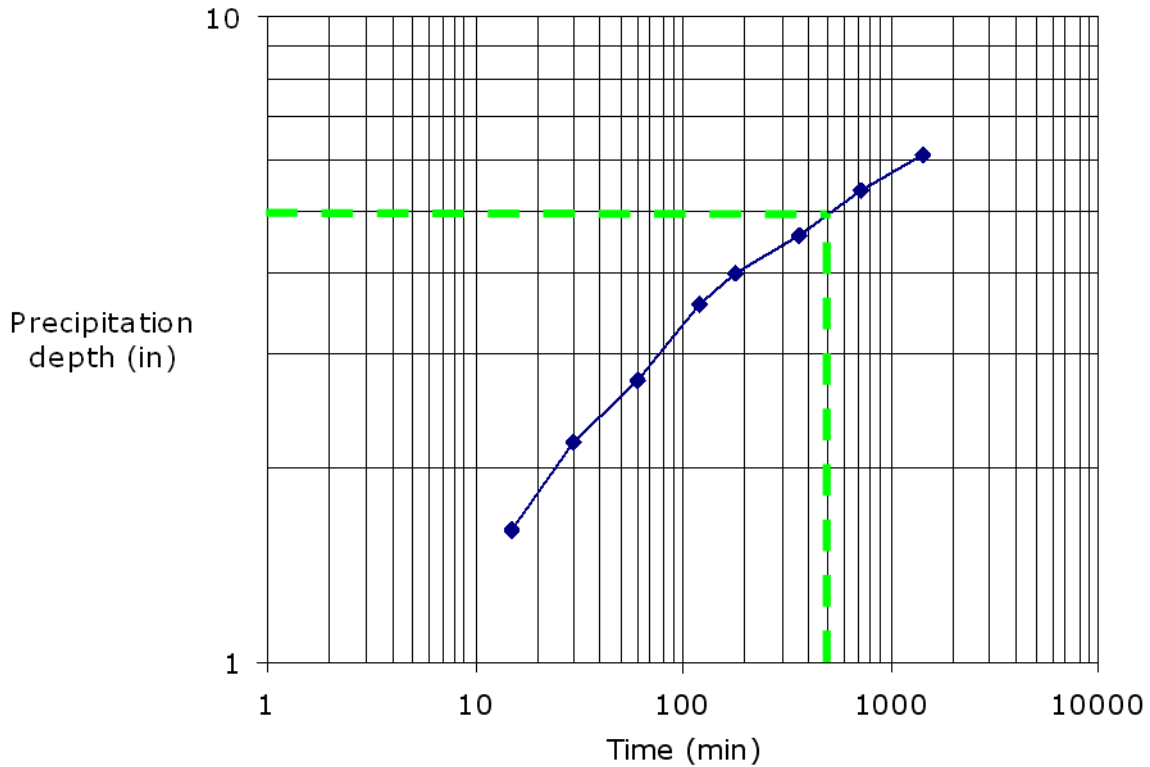

Figure 4-16. Log time versus log precipitation depth

4. Find the incremental depths by subtracting the cumulative depth at a particular time interval from the depth at the previous time interval.
5. Rearrange the incremental depths so that the peak depth is at the center of the storm and the remaining incremental depths alternate (to left and right of peak) in descending order.

For example, in Figure 4-17, the largest incremental depth for a 24-hour storm (1,440 minutes) is placed at the 720-minute time interval and the remaining incremental depths are placed about the 720-minute interval in alternating decreasing order.

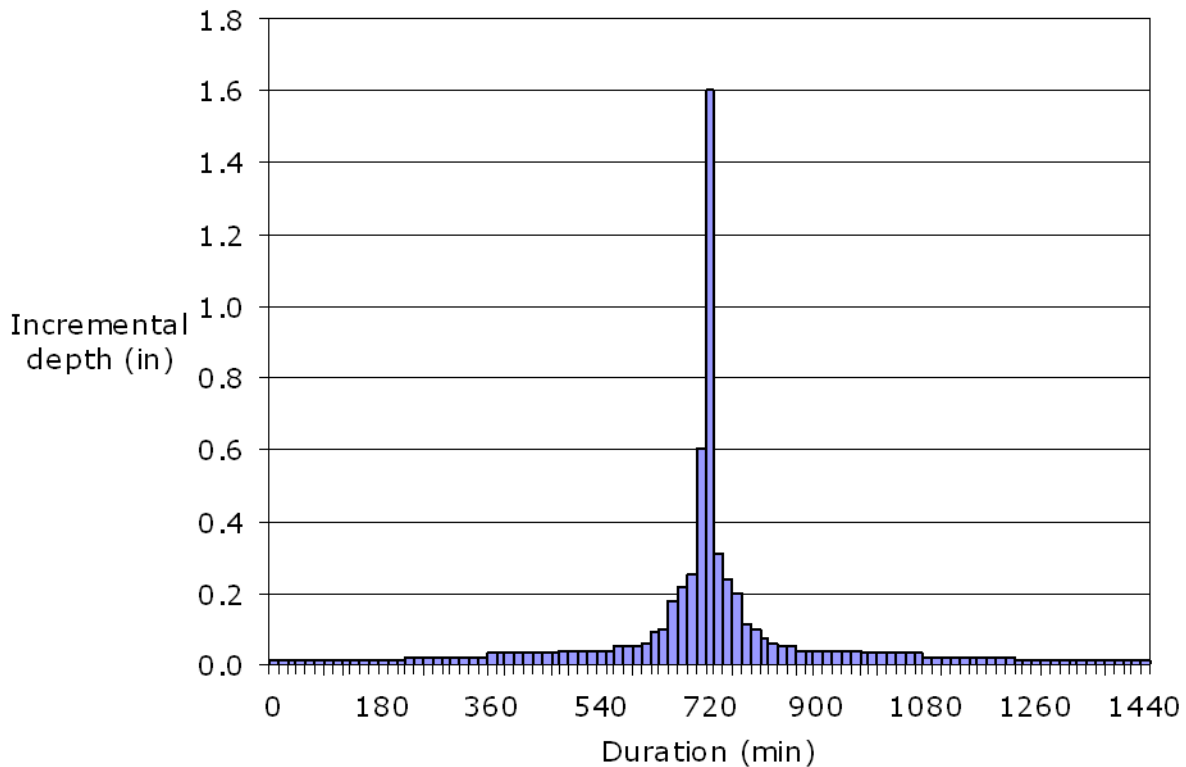

Figure 4-17. Balanced storm hyetograph

Texas Storm Hyetograph Development Procedure

Texas specific dimensionless hyetographs were developed by researchers at [USGS](#), [Texas Tech University](#), [University of Houston](#), and [Lamar University](#) (Williams-Sether et al. 2004, Asquith et al. 2005). Two databases were used to estimate the hyetographs: 1) rainfall recorded for more than 1,600 storms over mostly small watersheds as part of historical USGS studies, and 2) hourly rainfall data collection network from the NWS over eastern New Mexico, Oklahoma, and Texas.

Three methods of developing dimensionless hyetographs are presented: 1) triangular dimensionless hyetograph; 2) L-gamma dimensionless hyetograph; and 3) empirical dimensionless hyetograph. Any of these hyetographs can be used for TxDOT design. Brief descriptions of the three methods are presented here. For further information and example problems on the Texas hyetographs, refer to Asquith et al. 2005.

Triangular Dimensionless Hyetograph

A triangular dimensionless hyetograph is presented in Figure 4-18. The vertical axis represents relative rainfall intensity. The rainfall intensity increases linearly until the time of peak intensity, then decreases linearly until the end of the storm. The triangular hyetograph, in terms of relative cumu-

relative storm depth, is defined by Equations 4-26 and 4-27, with values for parameters a and b provided in Table 4-14.

$$p_1(0 \leq F \leq a) = \frac{1}{a}F^2$$

Equation 4-26.

$$p_2(a < F \leq 1) = \frac{1}{b}F^2 + \left(\frac{2a}{b} + 2\right)F - \left(\frac{a^2}{b} + a\right)$$

Equation 4-27.

Where:

p_1 = normalized cumulative rainfall depth, (ranging from 0 to 1) for F ranging from 0 to a

p_2 = normalized cumulative rainfall depth, (ranging from 0 to 1) for F ranging from a to 1

F = elapsed time, relative to storm duration, ranging from 0 to 1

a = relative storm duration prior to peak intensity, from Table 4-14

b = relative storm duration prior to peak intensity, from Table 4-14

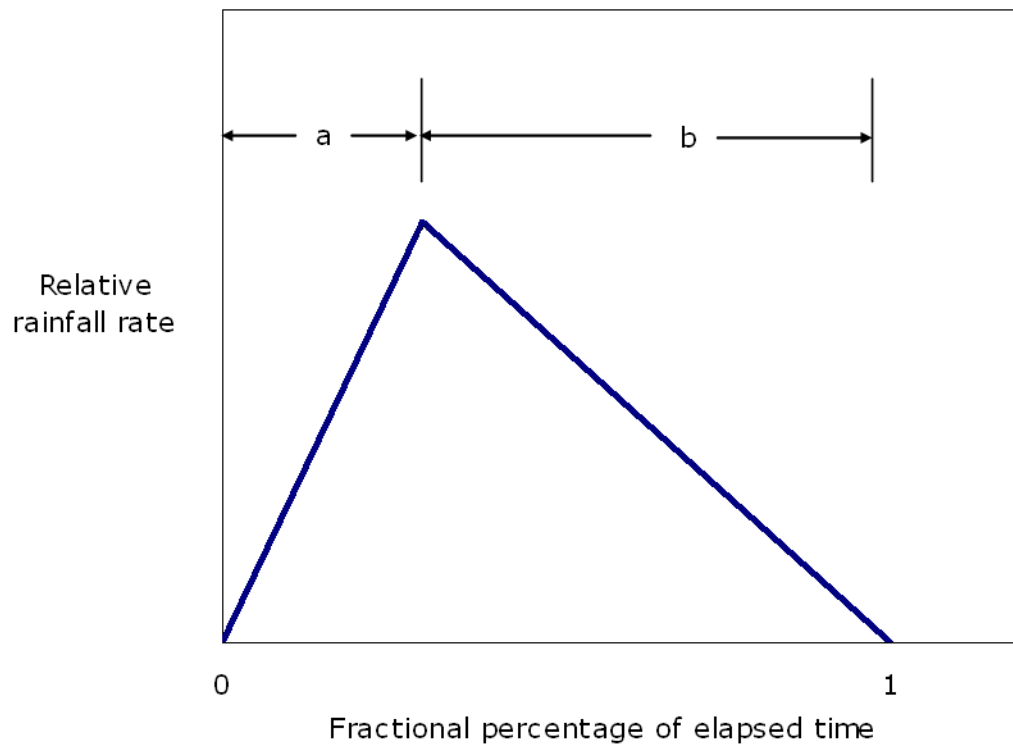

Figure 4-18. Triangular dimensionless Texas hyetograph

Table 4-14: Triangular Model Parameters a and b

Triangular hyetograph model parameters	Storm duration		
	5-12 hours	13-24 hours	25-72 hours
a	0.02197	0.28936	0.38959
b	0.97803	0.71064	0.61041

Based on the storm duration, the designer selects the appropriate parameters a and b for use in Equations 4-26 and 4-27. The ordinates of cumulative storm depth, normalized to total storm depth, are thus obtained. Values of rainfall intensity are obtained by computing total storm depth for durations of interest, and dividing by the duration.

Triangular Dimensionless Hyetograph Procedure

The following is an example computation using the triangular dimensionless hyetograph procedure for a 12-hour storm with cumulative depth of 8 inches:

1. Express F in Equations 4-26 and 4-27 in terms of time t and total storm duration T : $F = t / T$.
2. Express p in terms of cumulative rainfall depth d and total storm depth D : $p = d / D$.
3. Substituting into Equations 4-26 and 4-27 gives:

$$p_1 = \frac{d}{D} \left(0 \leq \frac{t}{T} \leq a \right) = \frac{1}{a} \left(\frac{t}{T} \right)^2$$

$$p_2 = \frac{d}{D} \left(a < \frac{t}{T} \leq 1 \right) = -\frac{1}{b} F^2 + \left(\frac{2a}{b} + 2 \right) F - \left(\frac{a^2}{b} + a \right)$$

4. From Table 4-14, $a = 0.02197$ and $b = 0.97803$.

$$p_1 = \frac{d}{D} \left(0 \leq \frac{t}{T} \leq 0.02197 \right) = \frac{1}{0.02197} \left(\frac{t}{T} \right)^2$$

$$p_2 = \frac{d}{D} \left(0.02197 < \frac{t}{T} \leq 1 \right) = -\frac{1}{0.97803} \left(\frac{t}{T} \right)^2 + \left(\frac{2(0.02197)}{0.97803} + 2 \right) \left(\frac{t}{T} \right) - \left(\frac{0.02197^2}{0.97803} + 0.02197 \right)$$

5. Substituting 12 (hours) for T and 8 (inches) for D gives:

$$p_1 = \frac{d}{8} \left(0 \leq \frac{t}{12} \leq 0.02197 \right) = \frac{1}{0.02197} \left(\frac{t}{12} \right)^2$$

$$p_2 = \frac{d}{8} \left(0.02197 < \frac{t}{12} \leq 1 \right) = -\frac{1}{0.97803} \left(\frac{t}{12} \right)^2 + \left(\frac{2(0.02197)}{0.97803} + 2 \right) \left(\frac{t}{12} \right) - \left(\frac{0.02197^2}{0.97803} + 0.02197 \right)$$

6. Simplifying:

$$p_1 = d(0 \leq t \leq 0.26364) = \frac{8}{0.02197} \left(\frac{t}{12} \right)^2$$

$$p_2 = d(0.26364 < t \leq 12) = \frac{8}{0.97803} \left(\frac{t}{12} \right)^2 + 8 \left(\frac{2(0.02197)}{0.97803} + 2 \right) \left(\frac{t}{12} \right) - 8 \left(\frac{0.02197^2}{0.97803} + 0.02197 \right)$$

These resulting equations provide cumulative depth in inches as a function of elapsed time in hours, as shown in Table 4-15.

Table 4-15: Example Dimensionless Hyetograph Ordinates

Time, t (hr.)	Precipitation Depth, d (in.)	Precipitation Intensity, I (in./hr.)
0	0	0
0.13	0.04	0.33
0.26	0.17	0.99
0.50	0.49	1.32
0.75	0.81	1.29

Table 4-15: Example Dimensionless Hyetograph Ordinates

Time, t (hr.)	Precipitation Depth, d (in.)	Precipitation Intensity, I (in./hr.)
1.00	1.13	1.26
2.00	2.32	1.19
3.00	3.40	1.08
4.00	4.36	0.97
5.00	5.22	0.85
6.00	5.96	0.74
7.00	6.58	0.62
8.00	7.09	0.51
9.00	7.49	0.40
10.00	7.77	0.28
11.00	7.94	0.17
12.00	8.00	0.06

L-gamma Dimensionless Hyetograph

Asquith (2003) and Asquith et al. (2005) computed sample L-moments of 1,659 dimensionless hyetographs for runoff-producing storms. Storms were divided by duration into 3 categories, 0 to 12 hours, 12 to 24 hours, and 24 to 72 hours. Dimensionless hyetographs based on the L-gamma distribution were developed and are defined by:

$$p(F) = F^b e^{c(1-F)}$$

Equation 4-28.

Where:

$$e = 2.718282$$

p = normalized cumulative rainfall depth, ranging from 0 to 1

F = elapsed time, relative to storm duration, ranging from 0 to 1

b = distribution parameter from Table 4-16

c = distribution parameter from Table 4-16

Parameters b and c of the L-gamma distribution for the corresponding storm durations are shown in Table 4-16. Until specific guidance is developed for selecting parameters for storms of exactly 12

hours and 24 hours, the designer should adopt distribution parameters for the duration range resulting in the more severe runoff condition.

Table 4-16: Estimated L-Gamma Distribution Parameters b and c

Storm duration	L-gamma distribution parameters	
	b	c
0 – 12 hours	1.262	1.227
12 – 24 hours	0.783	0.4368
24 - 72 hours	0.3388	-0.8152

L-gamma Dimensionless Hyetograph Procedure

Use the following steps to develop an L-gamma dimensionless Texas hyetograph for storm duration of 24 hours and a storm depth of 15 inches:

1. Enter the L-gamma distribution parameters for the selected storm duration into the following equation:

$$p(F) = F^{0.783} e^{0.4368(1-F)}$$

2. Express F in terms of time t and total storm duration T : $F = t/T$. Express p in terms of cumulative rainfall depth d and total storm depth D : $p = d/D$. Substituting gives:

$$d = D \left(\frac{t}{T} \right)^{0.783} e^{0.4368(1-t/T)}$$

3. Substitute 24 (hours) for T and 15 (inches) for D :

$$d = 15 \left(\frac{t}{24} \right)^{0.783} e^{0.4368(1-t/24)}$$

This equation defines the storm hyetograph. d is the cumulative depth in inches, and t is the elapsed time in hours.

Empirical Dimensionless Hyetograph

Empirical dimensionless hyetographs (Williams-Sether et al. 2004, Asquith et al. 2005) have been developed for application to small drainage areas (less than approximately 160 square miles) in urban and rural areas in Texas. The hyetographs are dimensionless in both duration and depth, and are applicable for storm durations ranging from 0 to 72 hours. The hyetograph shapes are not given by a mathematical expression, but are provided graphically in Figure 4-19, and are tabulated in Table 4-17.

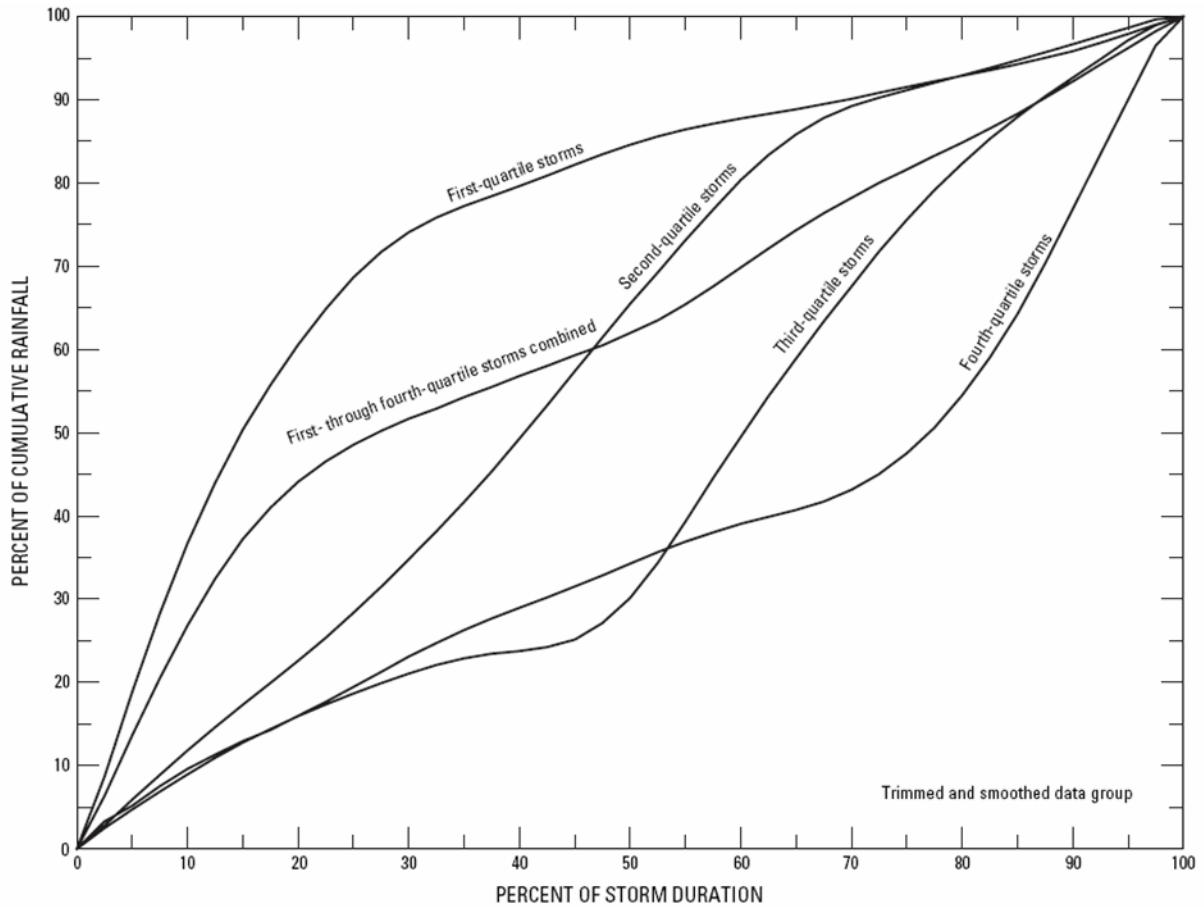

Figure 4-19. Dimensionless hyetographs for 0 to 72 hours storm duration (Williams-Sether et al. 2004)

Table 4-17: Median (50th-percentile) Empirical Dimensionless Hyetographs (Williams-Sether et al. 2004)

Storm duration (%)	1st quartile depth (%)	2nd quartile depth (%)	3rd quartile depth (%)	4th quartile depth (%)
0.0	0	0	0	0
2.5	8.70	2.81	2.51	3.28
5.0	18.81	5.89	4.73	5.16
7.5	28.27	8.89	6.86	7.53
10.0	36.71	11.82	8.96	9.59
12.5	43.93	14.60	10.92	11.30
15.0	50.35	17.32	12.76	12.93
17.5	55.74	19.93	14.41	14.30

Table 4-17: Median (50th-percentile) Empirical Dimensionless Hyetographs (Williams-Sether et al. 2004)

Storm duration (%)	1st quartile depth (%)	2nd quartile depth (%)	3rd quartile depth (%)	4th quartile depth (%)
20.0	60.57	22.61	15.95	15.98
22.5	64.85	25.34	17.34	17.64
25.0	68.65	28.36	18.66	19.46
27.5	71.70	31.47	19.91	21.27
30.0	74.09	34.77	21.05	23.10
32.5	75.85	38.14	22.08	24.71
35.0	77.23	41.69	22.89	26.30
37.5	78.42	45.34	23.45	27.67
40.0	79.62	49.29	23.77	28.95
42.5	80.86	53.27	24.24	30.19
45.0	82.20	57.39	25.14	31.51
47.5	83.43	61.42	27.11	32.86
50.0	84.59	65.46	30.15	34.27
52.5	85.59	69.27	34.37	35.65
55.0	86.42	73.09	39.28	36.92
57.5	87.12	76.77	44.53	38.02
60.0	87.75	80.35	49.48	39.04
62.5	88.28	83.34	54.35	39.90
65.0	88.85	85.85	58.90	40.72
67.5	89.46	87.80	63.36	41.71
70.0	90.10	89.24	67.56	43.15
72.5	90.81	90.23	71.75	45.03
75.0	91.53	91.15	75.58	47.52
77.5	92.22	92.03	79.15	50.60
80.0	92.87	92.90	82.29	54.45
82.5	93.54	93.81	85.28	59.01
85.0	94.25	94.75	87.93	64.24
87.5	95.01	95.69	90.36	70.27

Table 4-17: Median (50th-percentile) Empirical Dimensionless Hyetographs (Williams-Sether et al. 2004)

Storm duration (%)	1st quartile depth (%)	2nd quartile depth (%)	3rd quartile depth (%)	4th quartile depth (%)
90.0	95.84	96.66	92.62	76.81
92.5	96.82	97.64	94.86	83.44
95.0	97.90	98.63	97.15	90.01
97.5	99.02	99.65	98.94	96.48
100.0	100.00	100.00	100.00	100.00

Before applying the method, the designer determines the appropriate storm depth and duration for the [AEP](#) of interest. With the depth and duration defined, four dimensionless hyetographs, corresponding to the 1st, 2nd, 3rd, and 4th quartiles are defined. The quartile defines in which temporal quarter of the storm the majority of precipitation occurs. Until further guidance is provided by research, it is recommended that the designer consider all four quartile hyetographs, and select the one which produces the most severe design condition. Note that the combined 1st through 4th quartile hyetograph shown in Figure 4-19 is not presently recommended for design.

Confidence limits for the empirical dimensionless hydrographs have been computed for each of the four quartile hyetographs. These are available in the form of hyetographs representing 10th, 20th, 30th, 40th, 50th, 60th, 70th, 80th, and 90th percentiles confidence limits. The four quartile hydrographs recommended for design are in fact the 50th percentile, or median, percentile hyetographs. Because the hyetographs are dimensionless, all of the percentile hyetographs have the same dimensionless storm depth, but represent variations in the temporal distribution of rainfall during the storm duration. Percentile hyetographs are available and discussed further in Williams-Sether et al. 2004.

Models for Estimating Losses

Losses refer to the volume of rain falling on a watershed that does not run off. With each model, precipitation loss is found for each computation time interval, and is subtracted from the precipitation depth for that interval. The remaining depth is referred to as precipitation excess. This depth is considered uniformly distributed over a watershed area, so it represents a volume of runoff.

Loss models available to the TxDOT designer include:

- ◆ Initial and constant-rate loss model.
- ◆ Texas initial and constant-rate loss model.
- ◆ [NRCS](#) curve number loss model.

- ◆ Green and Ampt loss model.

Initial and Constant-Rate Loss Model

Basic Concepts and Equations

For the initial loss and constant-rate loss model, no runoff occurs in the watershed until an initial loss capacity has been satisfied, regardless of the rainfall rate. Once the initial loss has been satisfied, a constant potential loss rate occurs for the duration of the storm. This method is a simple approximation of a typical infiltration curve, where the initial loss decays over the storm duration to a final near-constant loss rate. In the example in Figure 4-20, the initial loss is satisfied in the first time increment, and the constant rate accounts for losses thereafter.

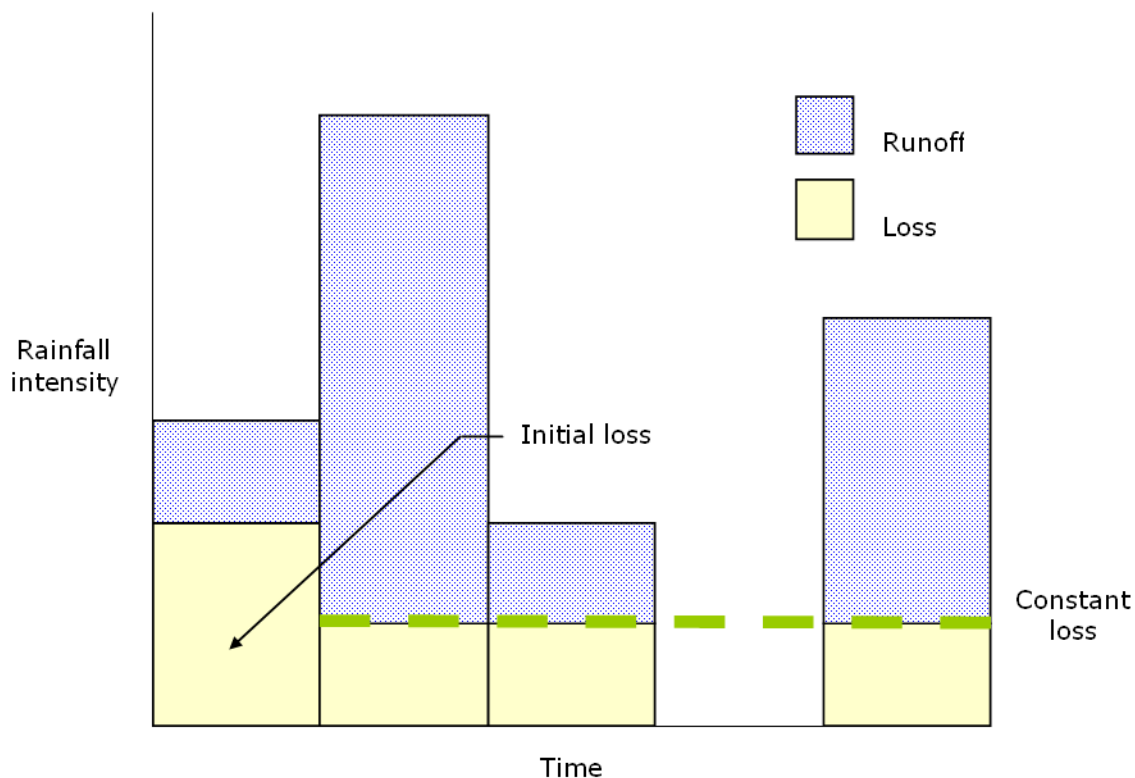

Figure 4-20. Initial and constant-loss rate model

The initial and constant loss-rate model is described mathematically as:

$$f(t) = I(t) \quad \text{for} \quad P(t) < I_a$$

Equation 4-29.

$$f(t) = I(t) - L \quad \text{for} \quad I(t) > L, P(t) \geq I_a$$

Equation 4-30.

$$f(t) = I(t) \quad \text{for} \quad I(t) \leq L$$

Equation 4-31.

Where:

$I(t)$ = rainfall intensity (in./hr.)

$f(t)$ = loss rate (in./hr.)

$P(t)$ = cumulative rainfall depth (in.) at time t

I_a = initial loss (in.)

L = constant loss rate (in./hr.)

I_a accounts for interception and depression storage, and the initial rate of infiltration at the beginning of the storm event. Interception refers to the capture of rainfall on the leaves and stems of vegetation before it reaches the ground surface. Depression storage is where the ponded rainfall fills small depressions and irregularities in the ground surface. Depression storage eventually infiltrates or evaporates during dry-weather periods. Until the accumulated precipitation on the pervious area exceeds the initial loss volume, no runoff occurs.

Estimating Initial Loss and Constant Rate

The initial and constant-rate loss model includes one parameter (the constant rate) and one initial condition (the initial loss). Respectively, these represent physical properties of the watershed soils and land use and the antecedent condition.

If the watershed is in a saturated state, I_a will approach 0. If the watershed is dry, then I_a will increase to represent the maximum precipitation depth that can fall on the watershed with no runoff; this will depend on the watershed terrain, land use, soil types, and soil treatment.

The constant loss rate can be viewed as the ultimate infiltration capacity of the soils. The [NRCS](#) classified soils on the basis of this infiltration capacity as presented in Table 4-18; values in Column 4 represent reasonable estimates of the rates.

Texas Initial and Constant-Rate Loss Model

Recent research (TxDOT 0-4193-7) developed four computational approaches for estimating initial abstraction (I_A) and constant loss (C_L) values for watersheds in Texas. The approaches are all based on the analysis of rainfall and runoff data of 92 gauged watersheds in Texas. One of those methods, presented here, allows the designer to compute I_A and C_L from regression equations:

$$I_A = 2.045 - 0.5497(L)^{0.9041} - 0.1943(D) + 0.2414(R) - 0.01354(CN)$$

Equation 4-32.

$$C_L = 2.535 - 0.4820(L)^{0.2312} + 0.2271(R) - 0.01676(CN)$$

Equation 4-33.

Where: I_A = initial abstraction (in.) C_L = constant loss rate (in./hr.) L = main channel length (mi.) $D = 0$ for undeveloped watersheds, 1 for developed watersheds $R = 0$ for non-rocky watersheds, 1 for rocky watersheds CN = NRCS curve number

In the above equations, L is defined as “the length in stream-course miles of the longest defined channel shown in a 30-meter digital elevation model from the approximate watershed headwaters to the outlet” (TxDOT 0-4193-7).

NRCS Curve Number Loss Model

[NRCS](#) has developed a procedure to divide total depth of rainfall into soil retention, initial abstractions, and effective rainfall. This parameter is referred to as a curve number (CN). The CN is based on soil type, land use, and vegetative cover of the watershed. The maximum possible soil retention is estimated using a parameter that represents the impermeability of the land in a watershed. Theoretically, CN can range from 0 (100% rainfall infiltration) to 100 (impervious). In practice, based on values tabulated in NRCS 1986, the lowest CN the designer will likely encounter is 30, and the maximum CN is 98.

Hydrologic Soil Groups

Soil properties influence the relationship between rainfall and runoff by affecting the rate of infiltration. NRCS divides soils into four hydrologic soil groups based on infiltration rates (Groups A-D). Urbanization has an effect on soil groups, as well. See Table 4-18 for more information.

Table 4-18: Hydrologic Soil Groups

Soil group	Description	Soil type	Range of loss rates	
			(in./hr.)	(mm/hr.)
A	Low runoff potential due to high infiltration rates even when saturated	Deep sand, deep loess, aggregated silts	0.30-0.45	7.6-11.4
B	Moderately low runoff potential due to moderate infiltration rates when saturated	Shallow loess, sandy loam	0.15-0.30	3.8-7.6

Table 4-18: Hydrologic Soil Groups

Soil group	Description	Soil type	Range of loss rates	
			(in./hr.)	(mm/hr.)
C	Moderately high runoff potential due to slow infiltration rates Soils in which a layer near the surface impedes the downward movement of water or soils with moderately fine to fine texture	Clay loams, shallow sandy loam, soils low in organic content, and soils usually high in clay	0.05-0.15	1.3-3.8
D	High runoff potential due to very slow infiltration rates	Soils that swell significantly when wet, heavy plastic clays, and certain saline soils	0.00-0.05	1.3

Estimating the CN

Rainfall infiltration losses depend primarily on soil characteristics and land use (surface cover). The NRCS method uses a combination of soil conditions and land use to assign runoff *CNs*. Suggested runoff curve numbers are provided in Table 4-19, Table 4-20, Table 4-21, and Table 4-22. Note that *CNs* are whole numbers.

For a watershed that has variability in land cover and soil type, a composite *CN* is calculated and weighted by area.

Table 4-19: Runoff Curve Numbers For Urban Areas

Cover type and hydrologic condition	Average percent impervious area	A	B	C	D
Open space (lawns, parks, golf courses, cemeteries, etc.):					
Poor condition (grass cover < 50%)		68	79	86	89
Fair condition (grass cover 50% to 75%)		49	69	79	84
Good condition (grass cover > 75%)		39	61	74	80
Paved parking lots, roofs, driveways, etc. (excluding right-of-way)		98	98	98	98
Streets and roads:					
Paved; curbs and storm drains (excluding right-of-way)		98	98	98	98
Paved; open ditches (including right-of-way)		83	89	92	93
Gravel (including right-of-way)		76	85	89	91

Table 4-19 notes: Values are for average runoff condition, and $I_a = 0.2S$.
 The average percent impervious area shown was used to develop the composite *CNs*.
 Other assumptions are: impervious areas are directly connected to the drainage system, impervious areas have a *CN* of 98, and pervious areas are considered equivalent to open space in good hydrologic condition.

Table 4-19: Runoff Curve Numbers For Urban Areas

Cover type and hydrologic condition	Average percent impervious area	A	B	C	D
Dirt (including right-of-way)		72	82	87	89
Western desert urban areas:					
Natural desert landscaping (pervious areas only)		63	77	85	88
Artificial desert landscaping (impervious weed barrier, desert shrub with 1- to 2-in. sand or gravel mulch and basin borders)		96	96	96	96
Urban districts:					
Commercial and business	85	89	92	94	95
Industrial	72	81	88	91	93
Residential districts by average lot size:					
1/8 acre or less (townhouses)	65	77	85	90	92
1/4 acre	38	61	75	83	87
1/3 acre	30	57	72	81	86
1/2 acre	25	54	70	80	85
1 acre	20	51	68	79	84
2 acres	12	46	65	77	82
Developing urban areas: Newly graded areas (pervious area only, no vegetation)		77	86	91	94
<p>Table 4-19 notes: Values are for average runoff condition, and $I_a = 0.2S$. The average percent impervious area shown was used to develop the composite CNs. Other assumptions are: impervious areas are directly connected to the drainage system, impervious areas have a CN of 98, and pervious areas are considered equivalent to open space in good hydrologic condition.</p>					

Table 4-20: Runoff Curve Numbers For Cultivated Agricultural Land

Cover type	Treatment	Hydrologic condition	A	B	C	D
Fallow	Bare soil	-	77	86	91	94
	Crop residue cover (CR)	Poor	76	85	90	93
		Good	74	83	88	90
<p>Table 4-20 notes: Values are for average runoff condition, and $I_a = 0.2S$. Crop residue cover applies only if residue is on at least 5% of the surface throughout the year. Hydrologic condition is based on a combination of factors affecting infiltration and runoff: density and canopy of vegetative areas, amount of year-round cover, amount of grass or closed-seeded legumes in rotations, percent of residue cover on land surface (good > 20%), and degree of roughness. Poor = Factors impair infiltration and tend to increase runoff. Good = Factors encourage average and better infiltration and tend to decrease runoff.</p>						

Table 4-20: Runoff Curve Numbers For Cultivated Agricultural Land

Cover type	Treatment	Hydrologic condition	A	B	C	D
Row crops	Straight row (SR)	Poor	72	81	88	91
		Good	67	78	85	89
	SR + CR	Poor	71	80	87	90
		Good	64	75	82	85
	Contoured (C)	Poor	70	79	84	88
		Good	65	75	82	86
	C + CR	Poor	69	78	83	87
		Good	64	74	81	85
	Contoured & terraced (C&T)	Poor	66	74	80	82
		Good	62	71	78	81
	C&T + CR	Poor	65	73	79	81
		Good	61	70	77	80
Small grain	SR	Poor	65	76	84	88
		Good	63	75	83	87
	SR + CR	Poor	64	75	83	86
		Good	60	72	80	84
	C	Poor	63	74	82	85
		Good	61	73	81	84
	C + CR	Poor	62	73	81	84
		Good	60	72	80	83
	C&T	Poor	61	72	79	82
		Good	59	70	78	81
	C&T + CR	Poor	60	71	78	81
		Good	58	69	77	80
Close-seeded or broadcast legumes or rotation meadow	SR	Poor	66	77	85	89
		Good	58	72	81	85
	C	Poor	64	75	83	85
		Good	55	69	78	83
	C&T	Poor	63	73	80	83
		Good	51	67	76	80

Table 4-20 notes: Values are for average runoff condition, and $I_a = 0.2S$. Crop residue cover applies only if residue is on at least 5% of the surface throughout the year. Hydrologic condition is based on a combination of factors affecting infiltration and runoff: density and canopy of vegetative areas, amount of year-round cover, amount of grass or closed-seeded legumes in rotations, percent of residue cover on land surface (good > 20%), and degree of roughness. Poor = Factors impair infiltration and tend to increase runoff. Good = Factors encourage average and better infiltration and tend to decrease runoff.

Table 4-21: Runoff Curve Numbers For Other Agricultural Lands

Cover type	Hydrologic condition	A	B	C	D
Pasture, grassland, or range-continuous forage for grazing	Poor	68	79	86	89
	Fair	49	69	79	84
	Good	39	61	74	80
Meadow – continuous grass, protected from grazing and generally mowed for hay	-	30	58	71	78
Brush – brush-weed-grass mixture, with brush the major element	Poor	48	67	77	83
	Fair	35	56	70	77
	Good	30	48	65	73
Woods – grass combination (orchard or tree farm)	Poor	57	73	82	86
	Fair	43	65	76	82
	Good	32	58	72	79
Woods	Poor	45	66	77	83
	Fair	36	60	73	79
	Good	30	55	70	77
Farmsteads – buildings, lanes, driveways, and surrounding lots	-	59	74	82	86
<p>Table 4-21 notes: Values are for average runoff condition, and $I_a = 0.2S$. Pasture: Poor is < 50% ground cover or heavily grazed with no mulch, Fair is 50% to 75% ground cover and not heavily grazed, and Good is > 75% ground cover and lightly or only occasionally grazed. Meadow: Poor is < 50% ground cover, Fair is 50% to 75% ground cover, Good is > 75% ground cover. Woods/grass: CNs shown were computed for areas with 50 percent grass (pasture) cover. Other combinations of conditions may be computed from CNs for woods and pasture. Woods: Poor = forest litter, small trees, and brush destroyed by heavy grazing or regular burning. Fair = woods grazed but not burned and with some forest litter covering the soil. Good = woods protected from grazing and with litter and brush adequately covering soil.</p>					

Table 4-22: Runoff Curve Numbers For Arid And Semi-arid Rangelands

Cover type	Hydrologic condition	A	B	C	D
Herbaceous—mixture of grass, weeds, and low-growing brush, with brush the minor element	Poor		80	87	93
	Fair		71	81	89
	Good		62	74	85
Oak-aspen—mountain brush mixture of oak brush, aspen, mountain mahogany, bitter brush, maple, and other brush	Poor		66	74	79
	Fair		48	57	63
	Good		30	41	48
Pinyon-juniper—pinyon, juniper, or both; grass understory	Poor		75	85	89
	Fair		58	73	80
	Good		41	61	71
Sagebrush with grass understory	Poor		67	80	85
	Fair		51	63	70
	Good		35	47	55
Saltbush, greasewood, creosote-bush, blackbrush, bursage, palo verde, mesquite, and cactus	Poor	63	77	85	88
	Fair	55	72	81	86
	Good	49	68	79	84
<p>Table 4-22 notes: Values are for average runoff condition, and $I_a = 0.2S$. Hydrologic Condition: Poor = < 30% ground cover (litter, grass, and brush overstory), Fair = 30% to 70% ground cover, Good = > 70% ground cover. Curve numbers for Group A have been developed only for desert shrub.</p>					

Soil Retention

The potential maximum retention (S) is calculated as:

$$S = z \left(\frac{100}{CN} - 1 \right)$$

Equation 4-34.

Where:

$z = 10$ for English measurement units, or 254 for metric

$CN =$ runoff curve number

Equation 4-34 is valid if S is less than the rainfall excess, defined as precipitation (P) minus runoff (R) or $S < (P - R)$. This equation was developed mainly for small watersheds from recorded storm data that included total rainfall amount in a calendar day but not its distribution with respect to time. Therefore, this method is appropriate for estimating direct runoff from 24-hour or 1-day storm rainfall.

Initial Abstraction

The initial abstraction consists of interception by vegetation, infiltration during early parts of the storm, and surface depression storage.

Generally, I_a is estimated as:

$$I_a = 0.2S$$

Equation 4-35.

Effective Rainfall Runoff Volume

The effective rainfall (or the total rainfall minus the initial abstractions and retention) used for runoff hydrograph computations can be estimated using:

$$P_e = \frac{(P - I_a)^2}{(P - I_a) + S}$$

Equation 4-36.

Where:

$P_e =$ accumulated excess rainfall (in.)

$I_a =$ initial abstraction before ponding (in.)

$P =$ total depth of rainfall (in.)

$S =$ potential maximum depth of water retained in the watershed (in.)

Substituting Equation 4-35, Equation 4-36 becomes:

$$P_e = \frac{(P - 0.2S)^2}{(P + 0.8S)}$$

Equation 4-37.

P_e and P have units of depth, P_e and P reflect volumes and are often referred to as volumes because it is usually assumed that the same depths occurred over the entire watershed. Therefore P_e is considered the volume of direct runoff per unit area, i.e., the rainfall that is neither retained on the surface nor infiltrated into the soil. P_e also can be applied sequentially during a storm to compute incremental precipitation for selected time interval Δt .

Climatic Adjustment of CN

NRCS curve numbers, estimated (predicted) using the procedure described in **Estimating the CN**, may be adjusted to account for the variation of climate within Texas. The adjustment is applied as follows:

$$CN_{obs} = CN_{pred} + CN_{dev}$$

Equation 4-38.

Where:

CN_{obs} = CN adjusted for climate

CN_{pred} = Estimated CN from NRCS procedures described in **Estimating the CN**

CN_{dev} = Deviation of CN_{obs} from CN_{pred} = climatic adjustment factor

In two studies (Halley and McGill 1983, Thompson et al. 2003) CN_{dev} was computed for gauged watersheds in Texas as $CN_{obs} - CN_{pred}$ based on historical rainfall and runoff volumes. These studies show that CN_{dev} varies by location within the state.

The following excerpt (Thompson et al. 2003) guides the designer in selection and application of the appropriate climatic adjustment to the predicted CN.

Given the differences between CN_{obs} and CN_{pred} , it is possible to construct a general adjustment to CN_{pred} such that an approximation of CN_{obs} can be obtained. The large amount of variation in CN_{obs} does not lend to smooth contours or function fits. There is simply an insufficient amount of information for these types of approaches. However, a general adjustment can be implemented using regions with a general adjustment factor. Such an approach was taken and is presented in Figure 4-21.

The bulk of rainfall and runoff data available for study were measured near the I-35 corridor. Therefore, estimates for this region are the most reliable. The greater the distance from the majority of the watershed that were part of this study, then the more uncertainty must be implied about the

results. For the south high plains, that area south of the Balcones escarpment, and the coastal plain, there was insufficient data to make any general conclusions.

Application of the tool is straightforward. For areas where adjustment factors are defined (see Figure 4-21) the analyst should:

- ◆ Determine CN_{pred} using the normal NRCS procedure.
- ◆ Find the location of the watershed on the design aid (Figure 4-21). Determine an adjustment factor from the design aid and adjust the curve number.
- ◆ Examine Figure 4-22 and find the location of the watershed. Use the location of the watershed to determine nearby study watersheds. Then refer to Figure 4-22 and Table 4-23, Table 4-24, Table 4-25, Table 4-26, and Table 4-27 and determine CN_{pred} and CN_{obs} for study watersheds near the site in question, if any are near the watershed in question.
- ◆ Compare the adjusted curve number with local values of CN_{obs} .

The result should be a range of values that are reasonable for the particular site.

As a comparison, the adjusted curve number from Hailey and McGill (Figure 4-23) can be used.

A lower bound equivalent to the curve number for AMC I (dry antecedent conditions), or a curve number of 60, whichever is greater, should be considered.

Note that CN values are whole numbers. Rounding of values of CN_{pred} in the tables may be required.

Judgment is required for application of any hydrologic tool. The adjustments presented on Figure 4-21 are no exception. A lower limit of AMC I may be used to prevent an overadjustment downward. For areas that have few study watersheds, the Hailey and McGill approach should provide some guidance on the amount of reduction to CN_{pred} is appropriate, if any.

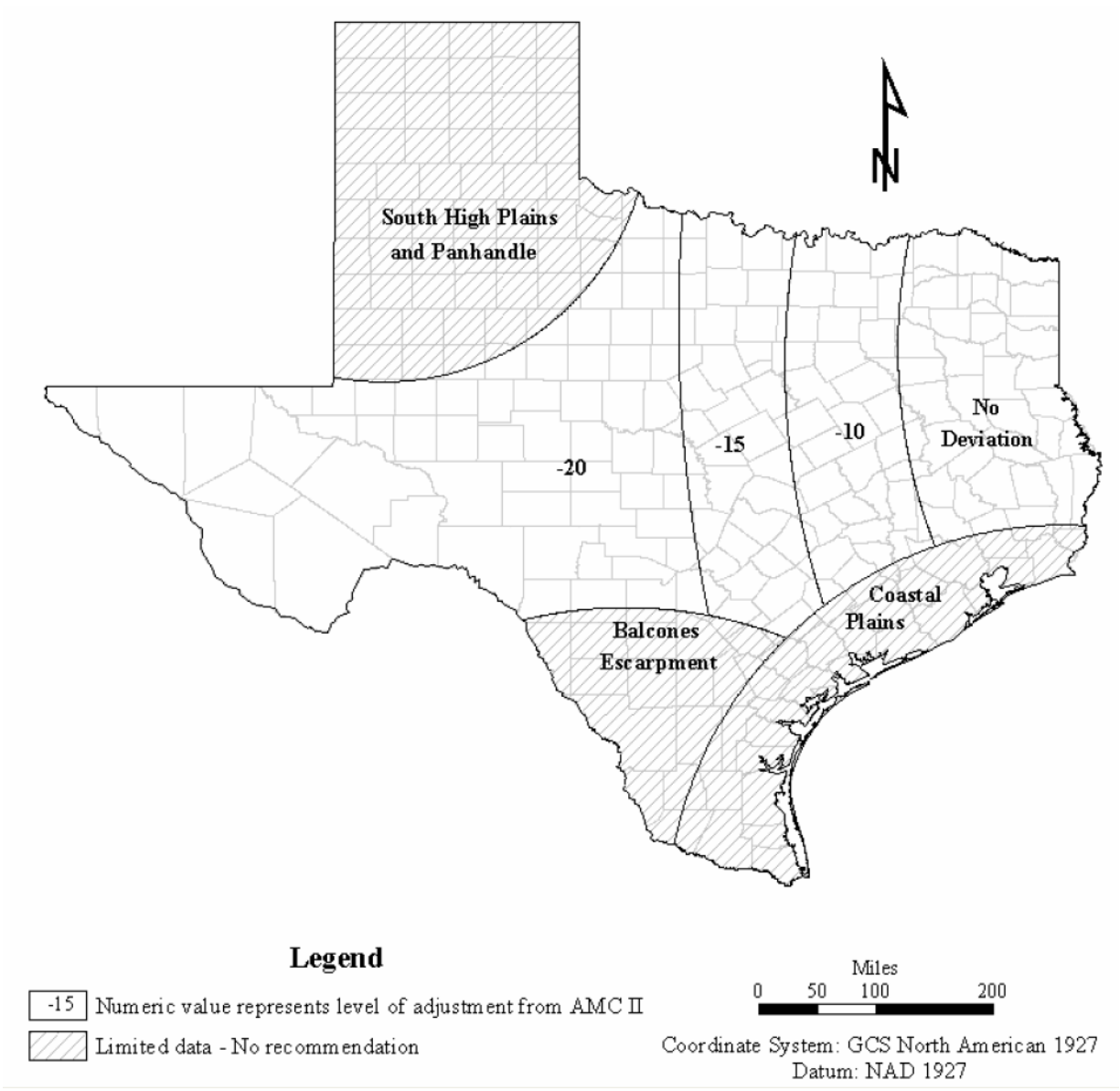

Figure 4-21. Climatic adjustment factor CN_{dev}



Figure 4-22. Location of CN_{dev} watersheds

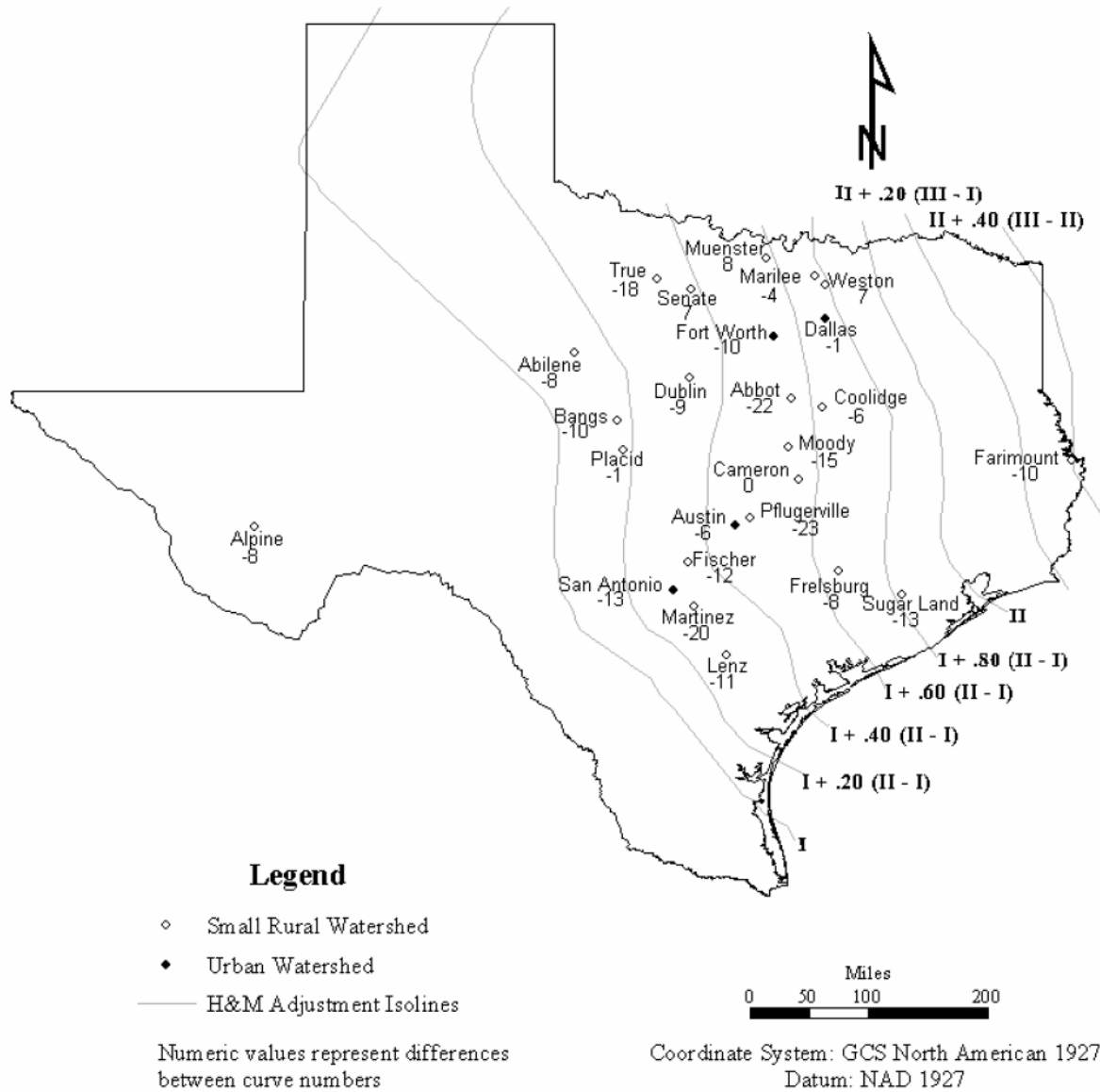

Figure 4-23. Climatic adjustment of CN - comparison of Hailey and McGill adjusted curve numbers, $CN_{H\&M}$, with CN_{obs} . Negative differences indicate that $CN_{H\&M}$ is larger than CN_{obs} . Also shown are the lines of equal adjustment to curve number from Hailey and McGill's (1983) Figure 4.

Table 4-23: CN_{obs} , CN_{pred} , and CN_{dev} for the Austin region

USGS Gauge ID	Quad Sheet Name	CN_{obs}	CN_{pred}	CN_{dev}
8154700	Austin West	59	68.9	-9.9
8155200	Bee Cave	65	70.7	-5.7
8155300	Oak Hill	64	69.8	-5.8
8155550	Austin West	50	87.3	-37.3

Table 4-23: CN_{obs} , CN_{pred} , and CN_{dev} for the Austin region

USGS Gauge ID	Quad Sheet Name	CN_{obs}	CN_{pred}	CN_{dev}
8156650	Austin East	60	83.6	-23.6
8156700	Austin East	78	86.6	-8.6
8156750	Austin East	66	86.8	-20.8
8156800	Austin East	66	87	-21
8157000	Austin East	68	88.3	-20.3
8157500	Austin East	67	89.1	-22.1
8158050	Austin East	71	83.9	-12.9
8158100	Pflugerville West	60	72.6	-12.6
8158200	Austin East	62	75.6	-13.6
8158400	Austin East	79	88.9	-9.9
8158500	Austin East	71	85.6	-14.6
8158600	Austin East	73	76.7	-3.7
8158700	Driftwood	69	74.5	-5.5
8158800	Buda	64	73.3	-9.3
8158810	Signal Hill	64	69.8	-5.8
8158820	Oak Hill	60	67.9	-7.9
8158825	Oak Hill	49	67.2	-18.2
8158840	Signal Hill	74	69.8	4.2
8158860	Oak Hill	60	68	-8
8158880	Oak Hill	67	79.4	-12.4
8158920	Oak Hill	71	77.5	-6.5
8158930	Oak Hill	56	75.2	-19.2
8158970	Montopolis	56	77.7	-21.7
8159150	Pflugerville East	63	78.8	-15.8

Table 4-24: CN_{obs} , CN_{pred} , and CN_{dev} for the Dallas Region

USGS Gauge ID	Quad Sheet Name	CN_{obs}	CN_{pred}	CN_{dev}
8055580	Garland	85	85.2	-0.2
8055600	Dallas	82	86.1	-4.1

Table 4-24: CN_{obs} , CN_{pred} , and CN_{dev} for the Dallas Region

USGS Gauge ID	Quad Sheet Name	CN_{obs}	CN_{pred}	CN_{dev}
8055700	Dallas	73	85.5	-12.5
8056500	Dallas	85	85.8	-0.8
8057020	Dallas	75	85.5	-10.5
8057050	Oak Cliff	75	85.7	-10.7
8057120	Addison	77	80.2	-3.2
8057130	Addison	89	82.9	6.1
8057140	Addison	78	86.8	-8.8
8057160	Addison	80	90.3	-10.3
8057320	White Rock Lake	85	85.7	-0.7
8057415	Hutchins	73	87.8	-14.8
8057418	Oak Cliff	85	79.1	5.9
8057420	Oak Cliff	80	81	-1
8057425	Oak Cliff	90	82.9	7.1
8057435	Oak Cliff	82	81.1	0.9
8057440	Hutchins	67	79.1	-12.1
8057445	Hutchins	60	86.5	-26.5
8061620	Garland	82	85	-3
8061920	Mesquite	85	86	-1
8061950	Seagoville	82	85.3	-3.3

Table 4-25: CN_{obs} , CN_{pred} , and CN_{dev} for the Fort Worth Region

Gauge ID	Quad Sheet Name	CN_{obs}	CN_{pred}	CN_{dev}
8048520	Fort Worth	72	82.3	-10.3
8048530	Fort Worth	69	86.7	-17.7
8048540	Covington	73	88	-15
8048550	Haltom City	74	91.2	-17.2
8048600	Haltom City	65	84.3	-19.3
8048820	Haltom City	67	83.4	-16.4
8048850	Haltom City	72	83	-11

Table 4-26: CN_{obs} , CN_{pred} , and CN_{dev} for the San Antonio Region

USGS Gauge ID	Quad Sheet Name	CN_{obs}	CN_{pred}	CN_{dev}
8177600	Castle Hills	70	84.8	-14.8
8178300	San Antonio West	72	85.7	-13.7
8178555	Southton	75	84.2	-9.2
8178600	Camp Bullis	60	79.7	-19.7
8178640	Longhorn	56	78.4	-22.4
8178645	Longhorn	59	78.2	-19.2
8178690	Longhorn	78	84.4	-6.4
8178736	San Antonio East	74	92.3	-18.3
8181000	Helotes	50	79.2	-29.2
8181400	Helotes	56	79.8	-23.8
8181450	San Antonio West	60	87.3	-27.3

Table 4-27: CN_{obs} , CN_{pred} , and CN_{dev} for the Small Rural Watersheds

USGS Gauge ID	Quadrangle Sheet Name	CN_{obs}	CN_{pred}	CN_{dev}
8025307	Fairmount	53	55.4	-2.4
8083420	Abilene East	65	84.7	-19.7
8088100	True	60	85.9	-25.9
8093400	Abbott	61	88.1	-27.1
8116400	Sugarland	70	82.9	-12.9
8159150	Pflugerville East	55	83.7	-28.7
8160800	Freisburg	56	67.8	-11.8
8167600	Fischer	51	74.3	-23.3
8436520	Alpine South	64	86.4	-22.4
8435660	Alpine South	48	86.7	-38.7
8098300	Rosebud	88	80.5	7.5
8108200	Yarrelton	77	79.9	-2.9
8096800	Bruceville	62	80	-18
8094000	Bunyan	60	78.4	-18.4
8136900	Bangs West	51	75.8	-24.8

Table 4-27: CN_{obs} , CN_{pred} , and CN_{dev} for the Small Rural Watersheds

USGS Gauge ID	Quadrangle Sheet Name	CN_{obs}	CN_{pred}	CN_{dev}
8137000	Bangs West	52	74.5	-22.5
8137500	Trickham	53	76.5	-23.5
8139000	Placid	53	74.6	-21.6
8140000	Mercury	63	74.4	-11.4
8182400	Martinez	52	80	-28
8187000	Lenz	53	83.8	-30.8
8187900	Kenedy	63	73.3	-10.3
8050200	Freemound	80	79.6	0.4
8057500	Weston	80	78.2	1.8
8058000	Weston	86	80.1	5.9
8052630	Marilee	80	85.4	-5.4
8052700	Aubrey	74	84.1	-10.1
8042650	Senate	59	63.4	-4.4
8042700	Lynn Creek	50	62.5	-12.5
8042700	Senate	56	62	-6
8042700	Senate	65	55.9	9.1
8063200	Coolidge	70	79.4	-9.4

Green and Ampt Loss Model

Basic Concepts and Equations

The Green and Ampt loss model is based on a theoretical application of Darcy's law. The model, first developed in 1911, has the form:

$$f = K_s + \frac{K_s S_w (\theta_s - \theta_i)}{F}$$

Equation 4-39.

Where:

f = infiltration capacity (in./hr.)

K_s = saturated hydraulic conductivity (permeability) (in./hr.)

S_w = soil water suction (in.)

θ_s = volumetric water content (water volume per unit soil volume) under saturated conditions

θ_i = volumetric moisture content under initial conditions

F = total accumulated infiltration (in.)

The parameters can be related to soil properties.

Assumptions underlying the Green and Ampt model are the following:

- ◆ As rain continues to fall and water infiltrates, the wetting front advances at the same rate throughout the groundwater system, which produces a well-defined wetting front.
- ◆ The volumetric water contents, θ_s and θ_i , remain constant above and below the wetting front as it advances.
- ◆ The soil-water suction immediately below the wetting front remains constant with both time and location as the wetting front advances.

To calculate the infiltration rate at a given time, the cumulative infiltration is calculated using Equation 4-40 and differences computed in successive cumulative values:

$$F = K_s t + S_w (\theta_s - \theta_i) \ln \left(1 + \frac{F}{S_w (\theta_s - \theta_i)} \right)$$

Equation 4-40.

Where:

t = time (hr.)

Equation 4-40 cannot be solved explicitly. Instead, solution by numerical methods is required. Once F is solved for, the infiltration rate, f , can be solved using Equation 4-39. These computations are typically performed by hydrologic computer programs equipped with Green-Ampt computational routines. With these programs, the designer is required to specify θ_s , S_w , and K_s .

Estimating Green-Ampt Parameters

To apply the Green and Ampt loss model, the designer must estimate the volumetric moisture content, θ_s , the wetting front suction head, S_w , and the saturated hydraulic conductivity, K_s . Rawls et al. (1993) provide Green-Ampt parameters for several USDA soil textures as shown in Table 4-28. A range is given for volumetric moisture content in parentheses with typical values for each also listed.

Table 4-28: Green-Ampt Parameters

Soil texture class	Volumetric moisture content under saturated conditions θ_s	Volumetric moisture content under initial conditions θ_i	Wetting front suction head S_w	Saturated hydraulic conductivity K_s
Sand	0.437 (0.374-0.500)	0.417 (0.354-0.480)	1.95	9.28
Loamy sand	0.437 (0.363-0.506)	0.401 (0.329-0.473)	2.41	2.35
Sandy loam	0.453 (0.351-0.555)	0.412 (0.283-0.541)	4.33	0.86
Loam	0.463 (0.375-0.551)	0.434 (0.334-0.534)	3.50	0.52
Silt loam	0.501 (0.420-0.582)	0.486 (0.394-0.578)	6.57	0.27
Sandy clay loam	0.398 (0.332-0.464)	0.330 (0.235-0.425)	8.60	0.12
Clay loam	0.464 (0.409-0.519)	0.309 (0.279-0.501)	8.22	0.08
Silty clay loam	0.471 (0.418-0.524)	0.432 (0.347-0.517)	10.75	0.08
Sandy clay	0.430 (0.370-0.490)	0.321 (0.207-0.435)	9.41	0.05
Silty clay	0.479 (0.425-0.533)	0.423 (0.334-0.512)	11.50	0.04
Clay	0.475 (0.427-0.523)	0.385 (0.269-0.501)	12.45	0.02

Capabilities and Limitations of Loss Models

Selecting a loss model and estimating the model parameters are critical steps in estimating runoff. Some pros and cons of the different alternatives are shown in Table 4-29. These are guidelines and should be used as such. The designer should be familiar with the models and the watershed where applied to determine which loss model is most appropriate.

Table 4-29: Comparison of Different Loss Models, Based on USACE 2000

Model	Pros	Cons
Initial and constant-loss rate	Has been successfully applied in many studies throughout the US. Easy to set up and use. Model only requires a few parameters to explain the variation of runoff parameters.	Difficult to apply to ungauged areas due to lack of direct physical relationship of parameters and watershed properties. Model may be too simple to predict losses within event, even if it does predict total losses well.
Texas initial and constant-loss rate	Developed specifically from Texas watershed data for application to sites in Texas. Method is product of recent and extensive research. Simple to apply.	Method is dependent on NRCS CN. Relatively new method, and not yet widely used.

Table 4-29: Comparison of Different Loss Models, Based on USACE 2000

Model	Pros	Cons
NRCS CN	Simple, predictable, and stable. Relies on only one parameter, which varies as a function of soil group, land use, surface condition, and antecedent moisture condition. Widely accepted and applied throughout the U.S.	Predicted values not in accordance with classical unsaturated flow theory. Infiltration rate will approach zero during a storm of long duration, rather than constant rate as expected. Developed with data from small agricultural watersheds in midwestern US, so applicability elsewhere is uncertain. Default initial abstraction (0.2S) does not depend upon storm characteristics or timing. Thus, if used with design storm, abstraction will be same with 0.5 AEP storm and 0.01 AEP storm. Rainfall intensity not considered.
Green and Ampt	Parameters can be estimated for ungauged watersheds from information about soils.	Not widely used, less experience in professional community.

Rainfall to Runoff Transform

After the design storm hyetograph is defined, and losses are computed and subtracted from rainfall to compute runoff volume, the time distribution and magnitude of runoff is computed with a rainfall to runoff transform.

Two options are described herein for these direct runoff hydrograph computations:

- ◆ Unit hydrograph (UH) model. This is an empirical model that relies on scaling a pattern of watershed runoff.
- ◆ Kinematic wave model. This is a conceptual model that computes the overland flow hydrograph method with channel routing methods to convert rainfall to runoff and route it to the point of interest.

Unit Hydrograph Method

A unit hydrograph for a watershed is defined as the discharge hydrograph that results from one unit depth of excess rainfall distributed uniformly, spatially and temporally, over a watershed for a duration of one unit of time. The unit depth of excess precipitation is one inch for English units. The unit of time becomes the time step of the analysis, and is selected as short enough to capture the detail of the storm temporal distribution and rising limb of the unit hydrograph.

The unit hydrograph assumes that the rainfall over a given area does not vary in intensity. If rainfall does vary, the watershed must be divided into smaller subbasins and varying rainfall applied with multiple unit hydrographs. The runoff can then be routed from subbasin to subbasin.

For each time step of the analysis, the unit hydrograph ordinates are multiplied by the excess rainfall depth. The resulting time-coincident ordinates from each resulting hydrograph are summed to produce the total runoff hydrograph for the watershed. This process is shown graphically in Figure 4-24. Hydrographs a, b, c, and d are 1-hour unit hydrographs multiplied by the depth of excess rainfall in the individual 1-hour time steps. The total runoff hydrograph resulting from 4 hours of rainfall is the sum of hydrographs a, b, c, and d.

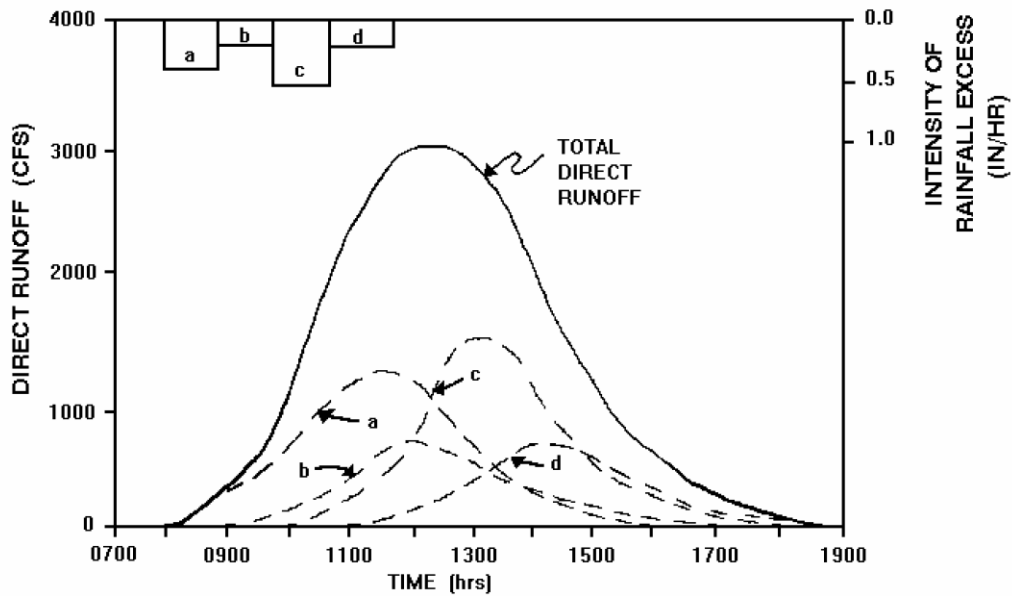

Figure 4-24. Unit hydrograph superposition (USACE 1994)

Mathematically, the computation of the runoff hydrograph is given by:

$$Q_n = \sum_{m=1}^{n \leq M} P_m Q_{u(n-m+1)}$$

Equation 4-41.

Where:

n = number of time steps

Q_n = the runoff hydrograph ordinate n (at time $n\Delta t$)

P_m = effective rainfall ordinate m (in time interval $m\Delta t$)

Δt = computation time interval

$Q_{u(n-m+1)}$ = unit hydrograph ordinate $(n-m+1)$ (at time $(n-m+1)\Delta t$)

m = number of periods of effective rainfall (of duration Δt)

M = total number of discrete rainfall pulses

Equation 4-41 simplified becomes $Q_1 = P_1U_1$, $Q_2 = P_1U_2+P_2U_1$, $Q_3 = P_1U_3+P_2U_2+P_3U_1$, etc.

Several different unit hydrograph methods are available to the designer. Each defines a temporal flow distribution. The time to peak flow and general shape of the distribution are defined by parameters specific to each method. The choice of unit hydrograph method will depend on available options within the hydrologic software being used, and also the availability of information from which to estimate the unit hydrograph parameters.

Two unit hydrograph methods commonly used by TxDOT designers are Snyder's unit hydrograph and the NRCS unit hydrograph. These methods are supported by many rainfall-runoff software programs, which require the designer only to specify the parameters of the method. These two methods are discussed in the following sections.

Snyder's Unit Hydrograph

Snyder developed a parametric unit hydrograph in 1938, based on research in the Appalachian Highlands using basins 10 to 10,000 square miles. Snyder's unit hydrograph is described with two parameters: C_t , which is a storage or timing coefficient; and C_p , which is a peaking coefficient. As C_t increases, the peak of the unit hydrograph is delayed. As C_p increases, the magnitude of the unit hydrograph peak increases. Both C_t and C_p must be estimated for the watershed of interest. Values for C_p range from 0.4 to 0.8 and generally indicate retention or storage capacity of the watershed.

The peak discharge of the unit hydrograph is given by:

$$Q_p = \frac{640AC_p}{t_L}$$

Equation 4-42.

Where:

Q_p = peak discharge (cfs/in.)

A = drainage area (mi²)

C_p = second coefficient of the Snyder method accounting for flood wave and storage conditions

t_L = time lag (hr.) from the centroid of rainfall excess to peak of hydrograph

t_L is given by:

$$t_L = C_t(LL_{ca})^{0.3}$$

Equation 4-43.

Where:

C_t = storage coefficient, usually ranging from 1.8 to 2.2

L = length of main channel (mi)

L_{ca} = length along the main channel from watershed outlet to the watershed centroid (mi)

The duration of excess rainfall (t_d) can be computed using:

$$t_d = \frac{t_L}{5.5}$$

Equation 4-44.

Equation 4-44 implies that the relationship between lag time and the duration of excess rainfall is constant. To adjust values of lag time for other values of rainfall excess duration, the following equation should be used:

$$t_{La} = t_L + 0.25(t_{da} - t_d)$$

Equation 4-45.

Where:

t_{La} = adjusted time lag (hr.)

t_{da} = alternative unit hydrograph duration (hr.)

The time base of the unit hydrograph is a function of the lag time:

$$t_b = 3 + \frac{t_L}{8}$$

Equation 4-46.

Where:

t_b = time base (days)

The time to peak of the unit hydrograph is calculated by:

$$t_p = t_L + \frac{t_d}{2}$$

Equation 4-47.

Empirical relations of Snyder's unit hydrograph were later found to aid the designer in constructing the unit hydrograph (McCuen 1989). The USACE relations, shown in Figure 4-25, are used to construct the Snyder unit hydrograph using the time to peak (t_p), the peak discharge (Q_p), the time base (t_b), and 2 time parameters, W_{50} and W_{75} . W_{50} and W_{75} are the widths of the unit hydrograph at discharges of 50 percent and 75 percent of the peak discharge. The widths are distributed 1/3 before the peak discharge and 2/3 after.

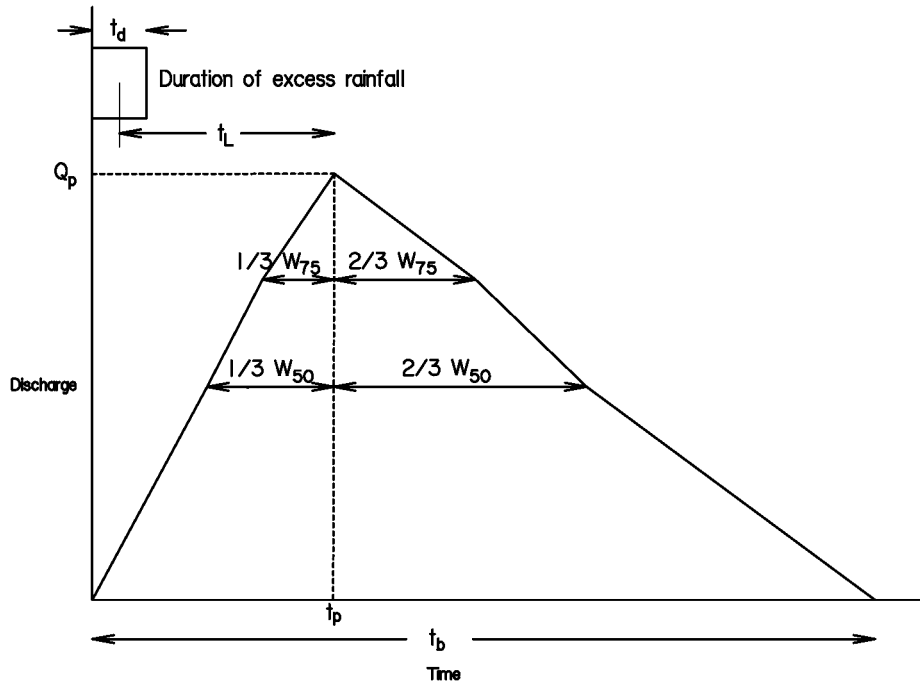

Figure 4-25. Snyder's unit hydrograph

Values for W_{50} and W_{75} are computed using these equations (McCuen 1989):

$$W_{75} = 450q_a^{-1.081}$$

Equation 4-48.

$$W_{50} = 756q_a^{-1.081}$$

Equation 4-49.

Where:

q_a = peak discharge per square mile (i.e., Q_p/A , $\text{ft}^3/\text{sec}/\text{mi}^2$)

NRCS Dimensionless Unit Hydrograph

The [NRCS](#) unit hydrograph model is based upon an analysis and averaging of a large number of natural unit hydrographs from a broad cross section of geographic locations and hydrologic regions. For convenience, the hydrograph is dimensionless, with discharge ordinates (Q_u) divided by the peak discharge (Q_p) and the time values (t) divided by the time to peak (t_p).

The time-base of the dimensionless unit hydrograph is approximately five times the time to peak, and approximately 3/8 of the total volume occurs before the time to peak. The inflection point on the recession limb occurs at 1.67 times the time to peak, and the hydrograph has a curvilinear shape. The curvilinear hydrograph can be approximated by a triangular hydrograph with similar characteristics.

A curvilinear dimensionless NRCS unit hydrograph is shown in Figure 4-26.

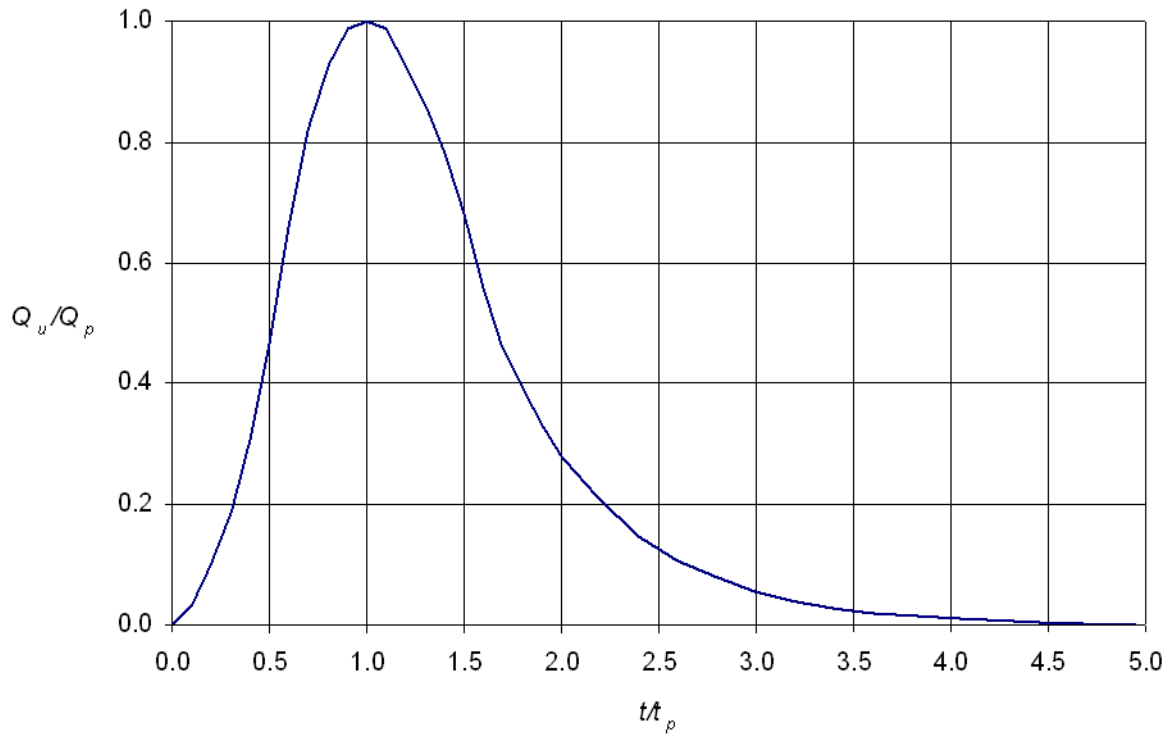

Figure 4-26. NRCS dimensionless unit hydrograph

The ordinates of the dimensionless unit hydrograph are provided in Table 4-30.

Table 4-30: NRCS Dimensionless Unit Hydrograph Ordinates

t/t_p	Q/Q_p
0.0	0.00
0.1	0.03
0.2	0.10
0.3	0.19
0.4	0.31
0.5	0.47
0.6	0.66
0.7	0.82
0.8	0.93
0.9	0.99
1.0	1.00
1.1	0.99
1.2	0.93

Table 4-30 notes: Variables are defined as follows: t = time (min.); t_p = time to peak of unit hydrograph (min.); Q = discharge (cfs); and Q_p = peak discharge of unit hydrograph (cfs).

Table 4-30: NRCS Dimensionless Unit Hydrograph Ordinates

t/t_p	Q/Q_p
1.3	0.86
1.4	0.78
1.5	0.68
1.6	0.56
1.7	0.46
1.8	0.39
1.9	0.33
2.0	0.28
2.2	0.207
2.4	0.147
2.6	0.107
2.8	0.077
3.0	0.055
3.2	0.04
3.4	0.029
3.6	0.021
3.8	0.015
4.0	0.011
4.5	0.005
5.0	0.00

Table 4-30 notes: Variables are defined as follows: t = time (min.); t_p = time to peak of unit hydrograph (min.); Q = discharge (cfs); and Q_p = peak discharge of unit hydrograph (cfs).

The following procedure assumes the area or subarea is reasonably homogeneous. That is, the watershed is subdivided into homogeneous areas. The procedure results in a hydrograph only from the direct uncontrolled area. If the watershed has been subdivided, it might be necessary to perform hydrograph channel routing, storage routing, and hydrograph superposition to determine the hydrograph at the outlet of the watershed.

Application of the [NRCS](#) dimensionless unit hydrograph to a watershed produces a site-specific unit hydrograph model with which storm runoff can be computed. To do this, the basin lag time must be estimated. The time to peak of the unit hydrograph is related to the lag time by:

$$t_p = \frac{\Delta t}{2} + t_L$$

Equation 4-50.

Where:

t_p = time to peak of unit hydrograph (min.)

t_L = basin lag time (min.)

Δt = the time interval of the unit hydrograph (min.)

This time interval must be the same as the Δt chosen for the design storm.

The time interval may be calculated by:

$$\Delta t = 0.133t_c$$

Equation 4-51.

And the lag time is calculated by:

$$t_L = 0.6t_c$$

Equation 4-52.

The peak discharge of the unit hydrograph is calculated by:

$$Q_p = \frac{C_f KA}{t_p}$$

Equation 4-53.

Where:

Q_p = peak discharge (cfs)

C_f = conversion factor (645.33)

$K = 0.75$ (constant based on geometric shape of dimensionless unit hydrograph)

A = drainage area (mi²); and

t_p = time to peak (hr.)

Equation 4-53 can be simplified to:

$$Q_p = \frac{484A}{t_p}$$

Equation 4-54.

The constant 484, or peak rate constant, defines a unit hydrograph with 3/8 of its area under the rising limb. As the watershed slope becomes very steep (mountainous), the constant in Equation 4-51 can approach a value of approximately 600. For flat, swampy areas, the constant may decrease to a value of approximately 300. For applications in Texas, the use of the constant 484 is recommended unless specific runoff data indicate a different value is warranted.

After t_p and Q_p are estimated using Equations 4-50 and 4-54, the site specific unit hydrograph may be developed by scaling the dimensionless unit hydrograph.

For example, Table 4-31 gives values for a basin with $\Delta t = 10$ minutes, $t_p = 40$ minutes, and $Q_p = 400$ cfs. Column 1 shows the time interval of 10 minutes. Column 2 is calculated by dividing the time interval by t_p , in this case 40 minutes. Values in Column 3 are found by using the t/t_p value in Column 2 to find the associated Q_u/Q_p value from the dimensionless unit hydrograph shown in Figure 4-26, interpolating if necessary. Column 4 is calculated by multiplying Column 3 by Q_p , in this case 400 cfs.

Table 4-31: Example Site-specific Unit Hydrograph

t (min.)	t/t_p	Q_u/Q_p	Q_u (cfs)
0	0.00	0.000	0
10	0.25	0.145	58
20	0.50	0.470	188
30	0.75	0.875	350
40	1.00	1.000	400
50	1.25	0.895	358
60	1.50	0.680	272
70	1.75	0.425	170
80	2.00	0.280	112
90	2.25	0.192	77
100	2.50	0.127	51
110	2.75	0.085	34
120	3.00	0.055	22
130	3.25	0.037	15
140	3.50	0.025	10
150	3.75	0.017	7
160	4.00	0.011	4
170	4.25	0.008	3
180	4.50	0.005	2
190	4.75	0.003	1
200	5.00	0.000	0

The capabilities and limitations of the [NRCS](#) unit hydrograph model include the following:

- ◆ This method should be used only for a 24-hour storm.
- ◆ This method does not account for variation in rainfall intensity or duration over the watershed.
- ◆ Baseflow is accounted for separately.

The example site-specific unit hydrograph is shown in Figure 4-27.

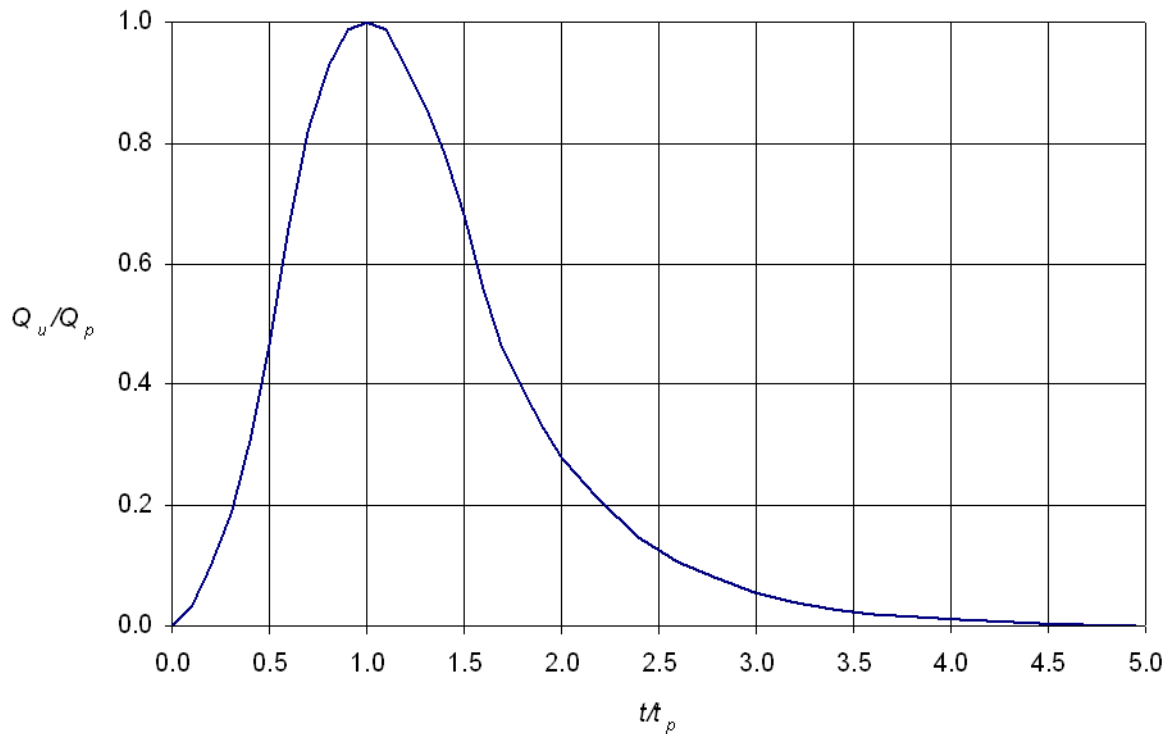

Figure 4-27. Example site-specific unit hydrograph

Kinematic Wave Overland Flow Model

A kinematic wave model is a conceptual model of watershed response that uses laws of conservation of mass and momentum to simulate overland and channelized flows. The model represents the watershed as a wide open channel, with inflow equal to the excess precipitation. Then it simulates unsteady channel flow over the surface to compute the watershed runoff hydrograph. The watershed is represented as a set of overland flow planes and collector channels.

In kinematic wave modeling, the watershed shown in Figure 4-28(a) is represented in Figure 4-28(b) as series of overland flow planes (gray areas) and a collector channel (dashed line). The collector channel conveys flow to the watershed outlet.

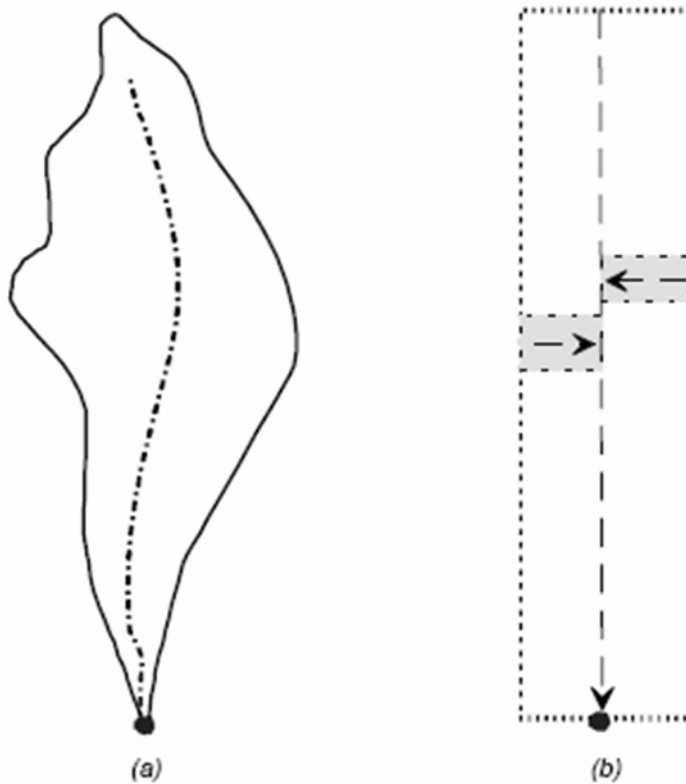

Figure 4-28. Kinematic wave model representation of a watershed (USACE 2000)

The equations used to define conservation of mass and momentum are the Saint Venant equations. The conservation of mass equation is:

$$\frac{\partial A}{\partial t} + \frac{\partial Q}{\partial x} = q_o$$

Equation 4-55.

Where:

A = cross sectional area of flow (ft², m²)

T = time (sec.)

Q = flow rate (cfs, m³/sec.)

x = distance along the flow path (ft, m)

q_o = lateral discharge added to the flow path per unit length of the flow path (cfs/ft, m³/sec./m)

The momentum equation energy gradient is approximated by:

$$A = \alpha Q^\beta$$

Equation 4-56.

Where:

α and β = coefficients related to the physical properties of the watershed.

Substituting Equation 4-56 into Equation 4-55 yields a single partial differential equation in Q :

$$\alpha Q^\beta \frac{\beta}{Q} \frac{\partial Q}{\partial t} + \frac{\partial Q}{\partial x} = q_L$$

Equation 4-57.

Where:

q_L = lateral inflow (cfs/ft, m³/s/m)

Equation 4-54 can be expressed in terms of Manning's n , wetted perimeter, and bed slope by substituting the following expression for αQ^β into Equation 4-56:

$$\alpha Q^\beta = \left(\frac{QnP^{2/3}}{1.49S_o^{1/2}} \right)^{3/5}$$

Equation 4-58.

Where:

n = Manning's roughness coefficient

P = wetted perimeter (ft, m)

S_o = flow plane slope (ft/ft, m/m)

The solution to the resulting equation, its terms, and basic concepts are detailed in Chow (1959) and other texts.

Hydrograph Routing

In some cases, the watershed of interest will be divided into subbasins. This is necessary when ground conditions vary significantly between subbasin areas, or when the total watershed area is sufficiently large that variations in precipitation depth within the watershed must be modeled. A rainfall-runoff method (unit hydrograph or kinematic wave) will produce a flow hydrograph at the outlet of each subbasin. Before these hydrographs can be summed to represent flow at the watershed outlet, the effects of travel time and channel/floodplain storage between the subbasin outlets and watershed outlet must be accounted for. The process of starting with a hydrograph at a location and recomputing the hydrograph at a downstream location is called hydrograph routing.

Figure 4-29 shows an example of a hydrograph at upstream location A, and the routed hydrograph at downstream location B. The resulting delay in flood peak is the travel time of the flood hydrograph. The resulting decrease in magnitude of the flood peak is the attenuation of the flood hydrograph.

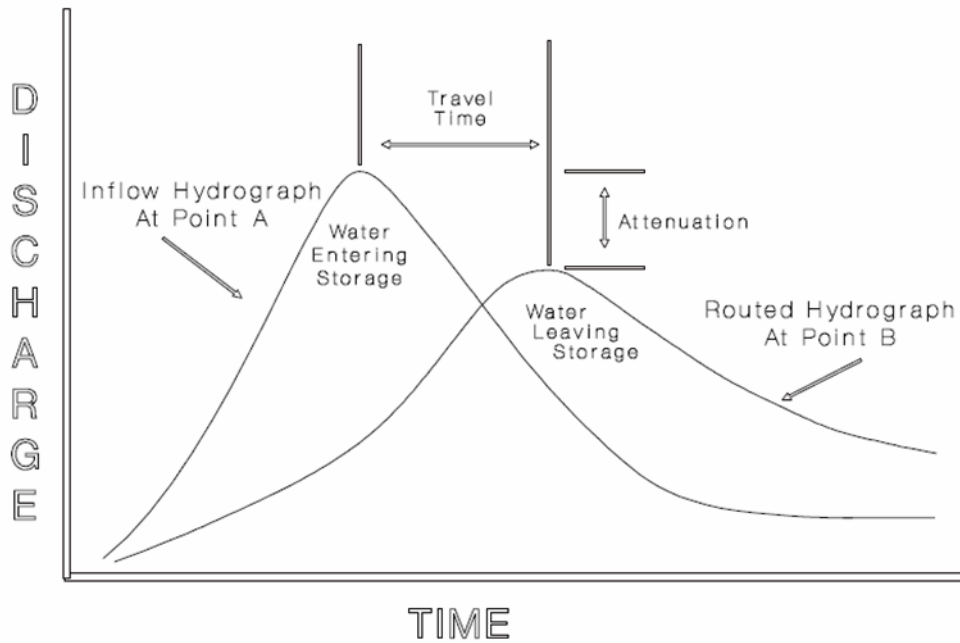

Figure 4-29. Hydrograph routing (USACE 1994)

There are two general methods for routing hydrographs: hydrologic and hydraulic. The methods are distinguished by which equations are solved to compute the routed hydrograph.

Hydrologic methods solve the equation of continuity (conservation of mass), and typically rely on a second relationship (such as relation of storage to outflow) to complete the solution. The equation of continuity can be written as:

$$I - O = \frac{\Delta S}{\Delta t}$$

Equation 4-59.

Where:

I = average inflow to reach or storage area during Δt

O = average outflow to reach or storage area during Δt

S = storage in reach or storage area

Δt = time step

Hydrologic methods are generally most appropriate for steep slope conditions with no significant backwater effects. Hydrologic routing methods include (USACE 1994):

- ◆ Modified Puls—for a single reservoir or channel modeled as series of level-pool reservoirs.
- ◆ Muskingum—channel modeled as a series of sloped-pool reservoirs.
- ◆ Muskingum-Cunge—enhanced version of Muskingum method incorporating channel geometry and roughness information.

Most hydrologic software applications capable of multi-basin analysis offer a selection of hydrologic routing methods.

Hydraulic routing methods solve the Saint Venant equations. These are the one-dimensional equations of continuity (Equation 4-60) and conservation of momentum (Equation 4-61) written for open-channel flow. The equations are valid for gradually varied unsteady flow.

The one-dimensional equation of continuity is:

$$A \frac{\partial V}{\partial x} + VB \frac{\partial y}{\partial x} + B \frac{\partial y}{\partial t} = q$$

Equation 4-60.

Where:

A = cross-sectional flow area

V = average velocity of water

x = distance along channel

B = water surface width

y = depth of water

t = time

q = lateral inflow per unit length of channel

The one-dimensional equation of conservation of momentum is:

$$S_f - S_o = \frac{\partial y}{\partial x} - \frac{V \partial y}{g \partial x} - \frac{1 \partial V}{g \partial t}$$

Equation 4-61.

Where:

S_f = friction slope

S_o = channel bed slope

g = acceleration due to gravity

Hydraulic routing methods are computationally more intensive than hydrologic methods and are distinguished by which terms in the momentum equation (Equation 4-61) are included (not neglected) in the solution algorithm. Hydraulic routing methods include (USACE 1994):

- ◆ Dynamic wave (all terms of St. Venant equations)
- ◆ Diffusion wave
- ◆ Kinematic wave

One-dimensional unsteady open-channel flow software applications implicitly route hydrographs from one location to another by solving for depth and velocity at all locations (cross sections) in a stream reach (or network of reaches) for every time step. The hydraulic routing method employed is defined by the solution algorithm of the software application. Some applications allow the user to select which hydraulic routing method is used, while other applications support only one method.

The most robust routing method (in terms of steep/mild stream slope and with/without backwater effects) is dynamic wave routing.

Selection of Routing Method

Selection of an appropriate routing method depends on several factors. The application of any method will be improved if observed data are available for calibration/verification of routing parameters. Generally, hydrologic methods are most suitable for steeper reaches having little or no backwater effects resulting from high stages downstream of the routing reach. Hydraulic methods are generally more appropriate for a wider range of channel slopes, including gradual slopes, and can accommodate backwater effects. The exception to this is the Muskingum-Cunge method, which does not perform well with steep-rising hydrographs in gradual slopes, or backwater conditions. Of all methods, only the dynamic wave routing method is appropriate for steep and gradual slopes, as well as with or without backwater conditions.

As a baseline approach, the designer may consider using the Muskingum-Cunge method in cases having steep slope (greater than 10 feet per mile) and no backwater effects. This method, which is described in Chow (1988) and Fread (1993), has the advantage that it will incorporate the shape of the cross section into computations. In some cases, cross section data may be obtained from existing hydraulic models of the reach. If channel geometry data are unavailable, then the Muskingum or modified Puls methods, which are described below, may be used. However, these two methods should be avoided for channel routing applications unless observed data are available for calibration/verification of routing parameters.

In cases having backwater that significantly affect the storage-outflow relationship of the routing reach, and thereby significantly affect the routed hydrograph, the dynamic wave, diffusion wave, and modified Puls methods are appropriate.

All methods, except for kinematic wave, are appropriate in cases having a channel slope between 2 to 10 feet per mile, no backwater effects, and satisfying the condition given by Equation 4-62 (USACE 1994):

$$\frac{TS_o u_o}{d_o} \geq 171$$

Equation 4-62.

Where:

T = hydrograph duration (s)

S_o = average friction or slope (ft/ft)

u_o = mean velocity (ft/s)

d_o = average flow depth (ft)

Only the dynamic wave, diffusion wave, and Muskingum-Cunge methods are appropriate in cases having a channel slope less than 2 feet per mile, no backwater effects, and satisfying the condition given by Equation 4-63 (USACE 1994):

$$TS_o \left(\frac{g}{d_o} \right)^{1/2} \geq 30$$

Equation 4-63.

Where:

$g = 32.2$ ft/s

In cases having a channel slope less than 2 feet per mile, no backwater effects, and not satisfying the condition given by Equation 4-63, then only the dynamic wave method is appropriate.

It may be tempting for the designer to select the dynamic wave routing method as a general approach for all conditions. However, the designer will find that the substantial amount of information (detailed and closely-spaced cross section geometry data) required to construct a one-dimensional unsteady flow model, and the significant time required to ensure that the model is running properly without numerical instabilities, will provide motivation to identify a suitable hydrologic routing method when appropriate. If hydrologic methods are not appropriate for the case under consideration, then an unsteady flow model may be required to properly route flows.

Reservoir Versus Channel Routing

Inflow hydrographs can be routed through reservoirs using a simple (single reservoir) hydrologic routing method, such as the modified Puls storage method. This is because the relationship between storage and discharge is unique (single-valued). In other words, the storage in the reservoir is fully

described by the stage in the reservoir because the surface of the reservoir is the same shape and slope during the rising and falling limbs of the hydrograph.

Hydrologic routing methods may also be used for channel routing. A channel does not have a single-valued storage-outflow curve. Instead, the storage-outflow relation is looped, as shown in Figure 4-30. As a result, a hydrologic routing method employing a single reservoir representation cannot be used.

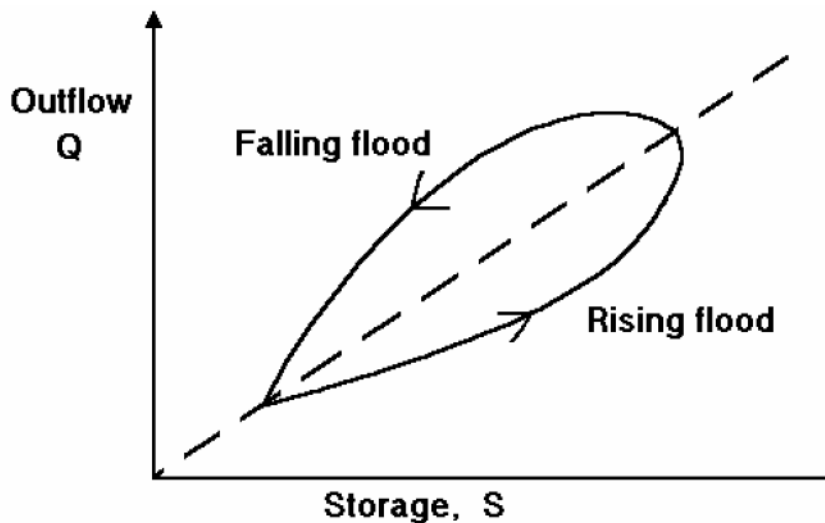

Figure 4-30. Looped storage outflow relation (USACE 1994)

The level-pool limitation of hydrologic routing methods is overcome by representing the channel as a series of reservoirs. These are termed subreaches, or steps, within the routing reach. Another enhancement to the level-pool approach, employed by the Muskingum method, is to represent the storage in each reservoir as a combination of prism storage (similar to level-pool reservoir) and wedge storage (additional sloped water on top of prism).

An estimate of the number of routing steps required for a hydrologic channel routing method is given by (USACE 1994):

$$n = \frac{K}{\Delta t}$$

Equation 4-64.

Where:

n = number of routing steps

K = floodwave travel time through the reach (min.)

Δt = time step (min.)

K in the above equation is given by:

$$K = \frac{L}{V_W}$$

Equation 4-65.

Where:

L = length of routing reach (ft)

V_W = flood wave velocity (ft/s)

V_W may be approximated as equal to the average channel velocity during the flood hydrograph. A better estimate of V_W is given by Seddon's law applied to a cross section representative of the routing reach (USACE 1994):

$$V_W = \frac{1}{B} \frac{dQ}{dy}$$

Equation 4-66.

Where:

B = top width of the channel water surface (ft)

Q = channel discharge (cfs) as function of elevation y

$\frac{dQ}{dy}$ = slope of the discharge rating curve (ft²/s)

Two hydrologic routing methods and their application are discussed further in the following sections: the modified Puls method for reservoir routing, and the Muskingum method for channel routing.

Modified Puls Method Reservoir Routing

Basic Concepts and Equations

The basic storage routing equation states that mass is conserved and can be expressed as follows:
Average inflow - average outflow = Rate of change in storage

In numerical form, this statement of flow continuity can be written as:

$$\frac{I_t + I_{t+1}}{2} - \frac{O_t + O_{t+1}}{2} = \frac{S_{t+1} - S_t}{\Delta t}$$

Equation 4-67.

Where:

I_t = inflow at time step number t

I_{t+1} = inflow at time step number $t + 1$

O_t = outflow at time step number t

O_{t+1} = outflow at time step number $t + 1$

S_t = storage in the reservoir at time step number t

S_{t+1} = storage in the reservoir at time step number $t + 1$

Δt = the time increment

t = time step number

In Equation 4-64 there are two unknowns: O_{t+1} and S_{t+1} . In order to solve Equation 4-64, either a second equation with O_{t+1} and S_{t+1} is required, or a relationship between O_{t+1} and S_{t+1} is needed. The storage-indication approach is the latter and is presented here. First, it is convenient to rewrite the routing equation as:

$$\frac{2S_{t+1}}{\Delta t} + O_{t+1} = I_t + I_{t+1} + \frac{2S_t}{\Delta t} - O_t$$

Equation 4-68.

In this form, all terms known at time t are on the right hand side of the equation and unknowns are on the left. If a single-valued storage-outflow curve can be determined for the routing reach, then for any value of O_{t+1} , the corresponding value of S_{t+1} will be known. This reduces the number of unknown parameters in Equation 4-65 from two (O_{t+1} and S_{t+1}) to one (O_{t+1}).

Use of the storage routing method requires the designer to determine the relationship between storage and outflow. This is simply the volume of water held by the reservoir, storage facility, or pond as a function of the water surface elevation or depth. For a reservoir or storage facility, this information is often available from the reservoir sponsor or owner.

For a pond or lake or where the stage-storage relation is not available, a relationship between storage and outflow can be derived from considerations of physical properties of channel or pond and simple hydraulic models of outlet works or relationship of flow and water surface elevation. These physical properties include:

- ◆ Ratings of the primary and/or emergency spillway of a reservoir.
- ◆ Pump flow characteristics in a pump station.
- ◆ Hydraulic performance curve of a culvert or bridge on a highway.
- ◆ Hydraulic performance curve of a weir and orifice outlet of a detention pond.

With the stage-storage relation established, a storage indication curve corresponding to the left side of Equation 4-68 is developed. The relationship is described in the form of O versus $(2S/\Delta T) + O$. An example of a storage indication curve is provided in Figure 4-31.

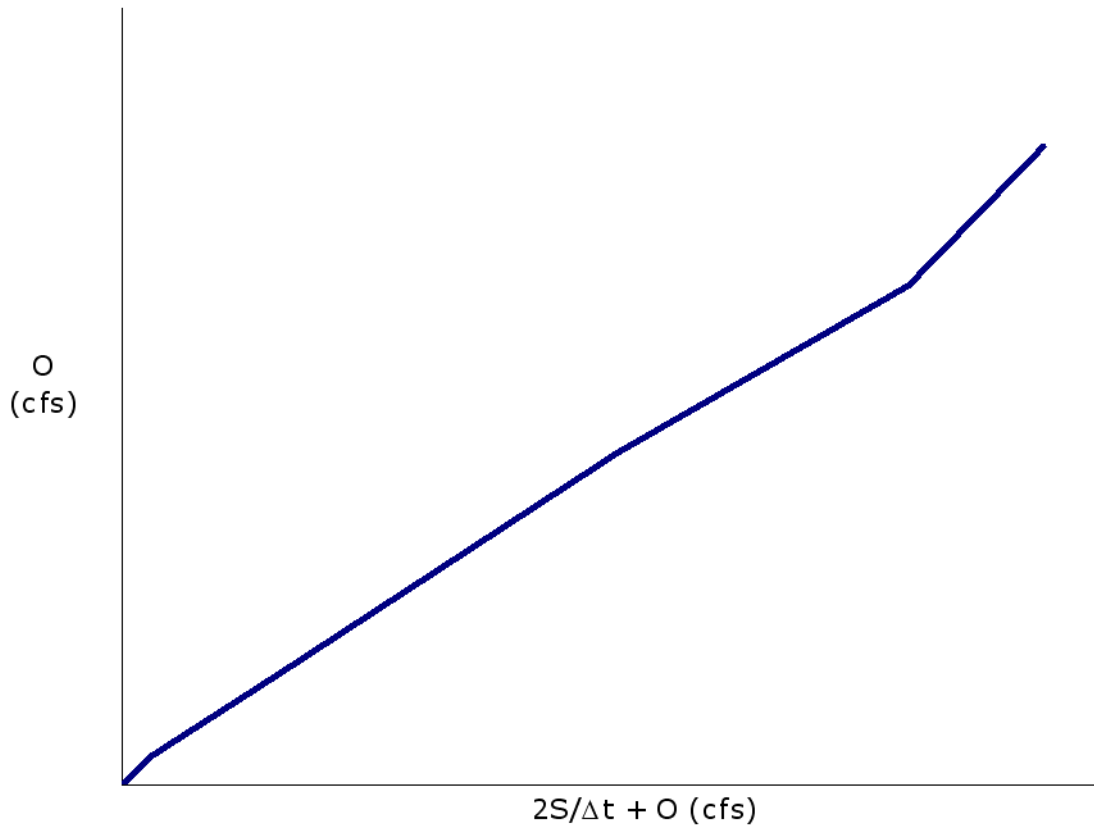

Figure 4-31. Sample storage-indication relation

The form of Equation 4-68 shown above is useful because the terms on the left side of the equation are known. With the relation between the outflow and storage determined (Figure 4-31), the ordinates on the outflow hydrograph can be determined directly.

Storage Routing Procedure

Use the following steps to route an inflow flood runoff hydrograph through a storage system such as a reservoir or detention pond:

1. Acquire or develop a design flood runoff hydrograph for the project site watershed.
2. Acquire or develop a stage-storage relation.
3. Acquire or develop a stage-outflow relationship.
4. Develop a storage-outflow relationship.

5. Assume an initial value for O_t as equal to I_t . At time step one ($t = 1$), assume an initial value for O_t as equal to I_t . Usually, at time step one, inflow equals zero, so outflow will be zero and $2S_1/\Delta T - O_1$ equals zero. Note that to start, $t + 1$ in the next step is 2.
6. Compute $2S_{t+1}/\Delta T + O_{t+1}$ using Equation 4-68.
7. Interpolate to find the value of outflow. From the storage-outflow relation, interpolate to find the value of outflow (O_{t+1}) at $(2S_{t+1})/(\Delta T) + O_{t+1}$ from step 6.
8. Determine the value of $(2S_{t+1})/(\Delta T) - O_{t+1}$. Use the relation $(2S_{t+1})/(\Delta T) - O_{t+1} = (2S_{t+1})/(\Delta T) + O_{t+1} - 2O_{t+1}$.
9. Assign the next time step to the value of t , e.g., for the first run through set $t = 2$.
10. Repeat steps 6 through 9 until the outflow value (O_{t+1}) approaches zero.
11. Plot the inflow and outflow hydrographs. The peak outflow value should always coincide with a point on the receding limb of the inflow hydrograph.
12. Check conservation of mass to help verify success of the process. Use Equation 4-69 to compare the inflow volume to the sum of retained and outflow volumes:

$$\Delta T \cdot \sum I_t = S_r + \Delta T \cdot \sum O_t$$

Equation 4-69.

Where:

S_r = difference in starting and ending storage (ft^3 or m^3)

$\sum I_t$ = sum of inflow hydrograph ordinates (cfs or m^3/s)

$\sum O_t$ = sum of outflow hydrograph ordinates (cfs or m^3/s)

Muskingum Method Channel Routing

Routing of flood hydrographs by means of channel routing procedures is useful in instances where computed hydrographs are at points other than the points of interest. This is also true in those instances where the channel profile or plan is changed in such a way as to alter the natural velocity or channel storage characteristics. Routing estimates the effect of a channel reach on an inflow hydrograph. This section describes the Muskingum method equations, a lumped flow routing technique that approximates storage effects in the form of a prism and wedge component (Chow 1988).

The Muskingum method also solves the equation of continuity. With the Muskingum method, the storage in the channel is considered the sum of two components: prism storage and wedge storage (Figure 4-32).

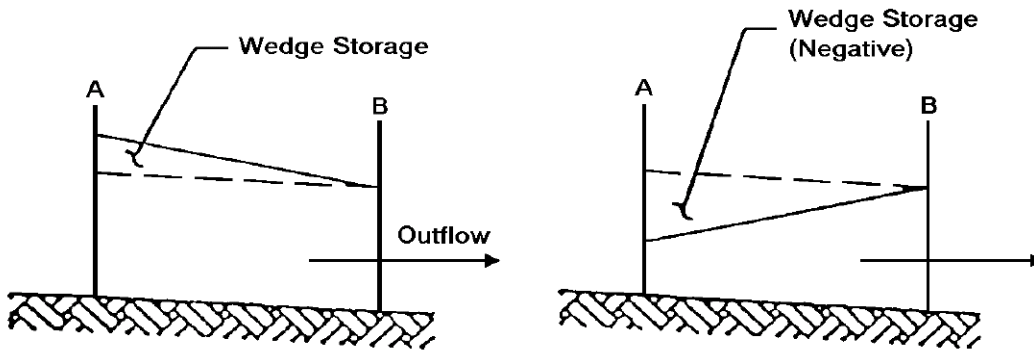

Figure 4-32. Muskingum prism and wedge storage

The constants K and X are used to relate the prism component, KO , and wedge component, $KX(I-O)$, to the inflow and outflow of the reach:

$$S = K[XI + (1 - X)O]$$

Equation 4-70.

Where:

S = total storage (ft³ or m³)

K = a proportionality constant representing the time of travel of a flood wave to traverse the reach (s). Often, this is set to the average travel time through the reach.

X = a weighting factor describing the backwater storage effects approximated as a wedge

I = inflow (cfs or m³/s)

O = outflow (cfs or m³/s)

The value of X depends on the amount of wedge storage; when $X = 0$, there is no backwater (reservoir type storage), and when $X = 0.5$, the storage is described as a full wedge. The weighting factor, X , ranges from 0 to 0.3 in natural streams. A value of 0.2 is typical.

Equation 4-68 represents the time rate of change of storage as the following:

$$\frac{S_{t+1} - S_t}{\Delta T} = \frac{K\{[XI_{t+1} + (1 - X)O_{t+1}] - [XI_t + (1 - X)O_t]\}}{\Delta T}$$

Equation 4-71.

Where:

ΔT = time interval usually ranging from 0.3K to K

t = time step number

Combining Equation 4-70 with Equation 4-71 yields the Muskingum flow routing equation:

$$O_{t+1} = C_1 I_{t+1} + C_2 I_t + C_3 O$$

Equation 4-72.

Where:

$$C_1 = \frac{\Delta T - 2KX}{2K(1 - X) + \Delta T}$$

Equation 4-73.

$$C_2 = \frac{\Delta T + 2KX}{2K(1 - X) + \Delta T}$$

Equation 4-74.

$$C_3 = \frac{2K(1 - X) - \Delta T}{2K(1 - X) + \Delta T}$$

Equation 4-75.

By definition, the sum of C_1 , C_2 , and C_3 is 1. If measured inflow and outflow hydrographs are available, K and X can be estimated using Equation 4-71. Calculate X by plotting the numerator on the vertical axis and the denominator on the horizontal axis, and adjusting X until the loop collapses into a single line. The slope of the line equals K :

$$K = \frac{0.5\Delta T[(I_{t+1} + I_t) - (O_{t+1} + O_t)]}{X(I_{t+1} - I_t) + (1 - X)(O_{t+1} - O_t)}$$

Equation 4-76.

The designer may also estimate K and X using the Muskingum-Cunge method described in Chow 1988 or Fread 1993.

Section 14 — References

- Anderson, E. A. (1972). NWSRFS Forecast Procedures, NOAA Technical Memorandum, NWS HYDRO-14, Office of Hydrologic Development, Hydrology Laboratory, NWS/NOAA, Silver Spring, MD.
- Asquith, W. H., and D. B. Thompson. (2008). [Alternative Regression Equations for Estimation of Annual Peak-Streamflow Frequency for Undeveloped Watersheds in Texas Using PRESS Minimization](#), US Geological Survey Scientific Investigations Report 2008–5084, Austin, TX. (TxDOT 0-5521-2)
- Asquith, W. H., and M. C. Roussel. (2007). [An Initial Abstraction, Constant-Loss Model for Unit Hydrograph Modeling for Applicable Watersheds in Texas](#), US Geological Survey Scientific Investigations Report 2007–5243, Austin, TX. (TxDOT 0-4193-7)
- Asquith, W.H., and M.C. Roussel. (2009) “Regression Equations for Estimation of Annual Peak-Streamflow Frequency for Undeveloped Watersheds in Texas Using and L-moment-Based, PRESS-Minimized, Residual-Adjusted Approach.” US Geological Survey Scientific Investigations Report 2009-5087, Austin, TX. (TxDOT 0-5521-1)
- Asquith, W. H., M. C. Roussel, and J. Vrabel. (2006). [Statewide Analysis of the Drainage-Area Ratio Method for 34 Streamflow Percentile Ranges in Texas](#), US Geological Survey Scientific Investigations Report 2006–5286, Austin, TX.
- Asquith, W. H., M. C. Roussel, D. B. Thompson, T. G. Cleveland, and X. Fang. (2005). [Summary of Dimensionless Texas Hyetographs and Distribution of Storm Depth](#), Developed for Texas Department of Transportation Research Project 0-4194, US Geological Survey, Austin, TX.
- Asquith, W. H., and M. C. Roussel. (2004). [Atlas of Depth-Duration Frequency of Precipitation Annual Maxima for Texas](#), US Geological Survey Scientific Investigations Report 2004-5041, Austin, TX. (TxDOT 5-1301-01-1)
- Asquith, W. H. (2003). [Modeling of Runoff-Producing Rainfall Hyetographs in Texas Using L-Moment Statistics](#), University of Texas at Austin, TX.
- Asquith, W. H. (1999). [Areal-Reduction Factors for the Precipitation of the 1-Day Design Storm in Texas](#), US Geological Survey Water-Resources Investigations Report 99-4267, Austin, TX.
- Asquith, W. H. (1998). [Depth-Duration Frequency of Precipitation for Texas](#), US Geological Survey Water-Resources Investigations Report 98-4044, Austin, TX.

- Asquith, W. H., and R. M. Slade, Jr. (1997). [Regional Equations for Estimation of Peak-Streamflow Frequency for Natural Basins in Texas](#), US Geological Survey Water-Resources Investigations Report 96-4307, Austin, TX.
- Asquith, W. H., R. M. Slade, Jr., and L. Judd. (1995). Analysis of Low-Outlier Thresholds for Log-Pearson Type III Peak-Streamflow Frequency Analysis in Texas, in Texas Water '95 Component Conference of American Society of Civil Engineers First International Conference, San Antonio, TX, Proceedings, San Antonio, TX, American Society of Civil Engineers.
- Chow, V. T. (1959). *Open Channel Hydraulics*, McGraw-Hill, Inc., New York, NY.
- Chow, V. T., D. R. Maidment, and L. W. Mays. (1988). *Applied Hydrology*, McGraw-Hill International Editions, Singapore.
- Dalrymple, Tate, and M.A. Benson (1960). [Flood-Frequency Analysis, Manual of Hydrology, Part 3: Flood-Flow Techniques](#), US Geological Survey Water Supply Paper, Number 1543-A.
- Frederick, Ralph H., Vance A. Myers, and Eugene P. Auciello. (1977). [NOAA Technical Memorandum NWS HYDRO-35: Five- to 60-minute Precipitation Frequency for the Eastern and Central United States](#), Silver Spring, MD.
- Hershfield, David M. (1961). [Technical Paper No. 40: Rainfall Frequency Atlas of the United States for Durations from 30 Minutes to 24 Hours and Return Periods from 1 to 100 Years](#), US Department of Commerce, Weather Bureau, Washington, D.C.
- Interagency Advisory Committee on Water Data (IACWD). (1982). [Guidelines for Determining Flood Flow Frequency, Bulletin #17B](#), US Geological Survey, Reston, VA.
- Judd, L. J., Asquith, W. H., Slade, R. M., Jr. (1996). [Techniques to Estimate Generalized Skew Coefficients of Annual Peak Streamflow for Natural Basins in Texas](#), US Geological Survey, Austin, TX.
- McCuen, Richard H. (1989) *Hydrologic Analysis and Design*, Prentice-Hall, Inc., Englewood Cliffs, NJ.
- Miller, John F. (1964). [Technical Paper No. 49: Two- to Ten-Day Precipitation for Return Periods of 2 to 100 Years in the Contiguous United States](#), US Department of Commerce, Weather Bureau, Washington, D.C.
- Natural Resources Conservation Service (NRCS). (1986). *Urban Hydrology for Small Watersheds—Technical Release 55*, Washington, D.C.
- Pilgrim, D. H., and I. Cordery. (1975). "Rainfall Temporal Patterns for Design Floods." [ASCE Journal of the Hydraulics Division](#), Vol. 101, No. HY1, Jan.

- Rawls, W. J., D. L. Brakensiek, and S. D. Logsdon. (1993). "Predicting Saturated Hydraulic Conductivity Utilizing Fractal Principles." *Soil Sci. Soc. Amer. J.* 57:1193-1197.
- Roussel, Meghan C., David B. Thompson, Xing Fang, Theodore G. Cleveland, and C. Amanda Garcia. (2005). [Time-Parameter Estimation for Applicable Texas Watersheds](#) Developed for Texas Department of Transportation Research Project Number 0-4696.
- Shearman, J.O., Kirby, W.H., Schneider, V.R. and Flippo, H.N. (1985). [Bridge Waterways Analysis Model: Research Report, FHWA/RD-86/108](#).
- U.S. Army Corps of Engineers (USACE). (2000). [Hydrologic Modeling System HEC-HMS Technical Reference Manual](#), Hydrologic Engineering Center, Davis, CA.
- U.S. Army Corps of Engineers (USACE). (1994). Engineer Manual 1110-2-1417, "[Engineering and Design Flood-Runoff Analysis](#)," Washington, D.C.
- U.S. Bureau of Reclamation Glossary, available at < <http://www.usbr.gov/library/glossary/>>
- [U.S. Department of Commerce](#), Weather Bureau. (1958). Rainfall Intensity-Frequency Regime, Part 3—the Middle Atlantic Region, Technical Paper No. 29, Washington, D.C.
- [U.S. Department of Transportation, Federal Highway Administration](#) (FHWA). (2001). [Urban Drainage Design Manual, Hydraulic Engineering Circular No. 22 \(HEC-22\), Second Edition](#), Washington, D.C.
- USGS Water Science Glossary of Terms, available at <<http://ga.water.usgs.gov/edu/dictionary.html>>
- [U.S. Geological Survey](#) (USGS). (2001). [The National Flood-Frequency Program—Methods for Estimating Flood Magnitude and Frequency for Natural Basins in Texas, 2001, USGS Fact Sheet 022-01](#).
- Viessman, W., G. L. Lewis, and J. W. Knapp. (1989). [Introduction to Hydrology](#), Harper & Row, New York, NY.
- [Water Education Foundation](#) (WEF) and [American Society of Civil Engineers](#) (ASCE). (1992). Design and Construction of Urban Stormwater Management Systems, ASCE Manuals and Reports of Engineering Practice No. 77, WEF Manual of Practice FD-20, New York, NY.
- Williams-Sether, T., W. H. Asquith, D. B. Thompson, T. G. Cleveland, and X. Fang. (2004). [Empirical, Dimensionless, Cumulative-Rainfall Hyetographs Developed from 1959-86 Storm Data for Selected Small Watersheds in Texas](#), US Geological Survey Scientific Investigations Report 2004-5075.

Section 15 — Glossary of Hydrology Terms

Annual Exceedance Probability (AEP)

The probability of exceedance in a given year.

Annual Flood

The maximum peak discharge in a water year.

Annual Flood Series

A list of annual floods.

Antecedent Conditions

Watershed conditions prevailing prior to an event; normally used to characterize basin wetness, e.g., soil moisture. Also referred to as initial conditions or antecedent moisture conditions (AMC).

Area-Capacity Curve

A graph showing the relation between the surface area of the water in a reservoir and the corresponding volume.

Attenuation

The reduction in the peak of a hydrograph resulting in a broad, flat hydrograph.

Backwater

Water backed up or retarded in its course as compared with its normal or natural condition of flow. In stream gauging, a rise in stage produced by a temporary obstruction such as ice or weeds, or by the flooding of the stream below. The difference between the observed stage and that indicated by the stage-discharge relation is reported as backwater.

Bank

The margins of a channel. Banks are called right or left as viewed facing downstream (in the direction of the flow).

Bank Storage

The water absorbed into the banks of a stream channel, when the stages rise above the water table in the bank formations, then returns to the channel as effluent seepage when the stages fall below the water table.

Bankfull Stage

Maximum stage of a stream before it overflows its banks. (see also flood stage.)

Base Discharge (for peak discharge)

In the USGS annual reports on surface-water supply, the discharge above which peak discharge data are published. The base discharge at each station is selected so that an average of about 3 peaks a year will be presented. (See also partial-duration flood series.)

Baseflow

The sustained or fair weather flow in a channel due to subsurface runoff. In most streams, baseflow is composed largely of groundwater effluent. Also known as base runoff.

Basic Hydrologic Data

Includes inventories of features of land and water that vary spatially (topographic and geologic maps are examples), and records of processes that vary with both place and time. (Records of precipitation, streamflow, ground water, and quality-of-water analyses are examples.) Basic hydrologic information is a broad term that includes surveys of the water resources of particular areas and a study of their physical and related economic processes, interrelations, and mechanisms.

Basic-Stage Flood Series

See partial duration flood series.

Bifurcation

The point where a stream channel splits into two distinct channels.

Binomial Statistical Distribution

The frequency distribution of the probability of a specified number of successes in an arbitrary number of repeated independent Bernoulli trials. Also called *Bernoulli distribution*.

Boundary Condition

Conditions at the boundary of a problem that govern its solution. For example, when solving a routing problem for a given reach, an upstream inflow boundary condition is necessary to solve for the outflow at the downstream end of the reach.

Calibration

Derivation of a set of model parameter values that produces the best fit to observed data.

Canopy-Interception

Precipitation that falls on and is stored in the leaves or trunks of vegetation. The term can refer to either the process or a volume.

Channel (watercourse)

An open conduit either naturally or artificially created which periodically or continuously contains moving water, or which forms a connecting link between two bodies of water. River, creek, run, branch, anabranch, and tributary are some of the terms used to describe natural channels. Natural channels may be single or braided. Canal and floodway are terms used to describe artificial channels.

Channel Storage

The volume of water at a given time in the channel or over the flood plain of the streams in a drainage basin or river reach. Channel storage can be large during the progress of a flood event.

Computation Duration

The user-defined time window used in hydrologic modeling.

Computation Interval

The user-defined time step used by a hydrologic model for performing mathematical computations. For example, if the computation interval is 15 min. and the starting time is 1200, hydrograph ordinates will be computed at 1200, 1215, 1230, 1245, and so on.

Concentration Time

See time of concentration.

Confluence

The point at which two distinct stream channels converge

Continuous Model

A model that tracks the periods between precipitation events, as well as the events themselves. See event-based model.

Correlation

The process of establishing a relation between a variable and one or more related variables. Correlation is simple if there is only one independent variable and multiple when there are two or more independent variables. For gauging station records, the usual variables are the short-term gauging-station record and one or more long-term gauging-station records

Dendritic

Channel pattern of streams with tributaries that branch to form a tree-like pattern.

Depression Storage

The volume of water contained in natural depressions in the land surface, such as puddles.

Design Flood

The flood that is chosen as the basis for the design of a hydraulic structure.

Design Storm

Rainfall amount and distribution in time and space used to determine a design flood or design peak discharge

Detention Basin

Storage facility, such as a small unregulated reservoir, which delays the conveyance of water downstream.

Diffusion

Dissipation of the energy associated with a flood wave; results in the attenuation of the flood wave.

Direct Runoff

The runoff entering stream channels promptly after rainfall or snowmelt. Superimposed on base runoff, it forms the bulk of the hydrograph of a flood. See also surface runoff. The terms base runoff and direct runoff are time classifications of runoff. The terms groundwater runoff and surface runoff are classifications according to source.

Discharge

The volume of water that passes through a given cross-section per unit time; commonly measured in cubic feet per second (cfs) or cubic meters per second (m^3/s). Also referred to as flow.

In its simplest concept discharge means outflow; therefore, the use of this term is not restricted as to course or location, and it can be applied to describe the flow of water from a pipe or from a drainage basin. If the discharge occurs in some course or channel, it is correct to speak of the discharge of a canal or of a river. It is also correct to speak of the discharge of a canal or stream into a lake, a stream, or an ocean. (See also streamflow and runoff.)

Discharge data in USGS reports on surface water represent the total fluids measured. Thus, the terms discharge, streamflow, and runoff represent water with sediment and dissolved solids. Of these terms, discharge is the most comprehensive. The discharge of drainage basins is distinguished as follows:

Yield: Total water runoff; includes runoff plus underflow.

Runoff: That part of water yield that appears in streams.

Streamflow: The actual flow in streams, whether or not subject to regulation, or underflow.

Each of these terms can be reported in total volumes or time rates. The differentiation between runoff as a volume and streamflow as a rate is not accepted.

Discharge Rating Curve

See stage discharge relation.

Distribution Graph (distribution hydrograph)

A unit hydrograph of direct runoff modified to show the proportions of the volume of runoff that occurs during successive equal units of time.

Diversion

The taking of water from a stream or other body of water into a canal, pipe, or other conduit.

Drainage Area

The drainage area of a stream at a specified location is that area, measured in a horizontal plane, which is enclosed by a drainage divide.

Drainage Divide

The rim of a drainage basin. (See watershed.)

Duration Curve

See flow-duration curve for one type.

ET

See evapotranspiration.

Effective Precipitation (rainfall)

1. That part of the precipitation that produces runoff.
2. A weighted average of current and antecedent precipitation that is "effective" in correlating with runoff.

Evaporation

The process by which water is changed from the liquid or the solid state into the vapor state. In hydrology, evaporation is vaporization and sublimation that takes place at a temperature below the boiling point. In a general sense, evaporation is often used interchangeably with evapotranspiration or ET.

Evaporation Demand

The maximum potential evaporation generally determined using an evaporation pan. For example, if there is sufficient water in the combination of canopy and surface storage, and in the soil profile, the actual evaporation will equal the evaporation demand. A soil-water retention curve describes

the relationship between evaporation demand and actual evaporation when the demand is greater than available water. See tension zone.

Evaporation Pan

An open tank used to contain water for measuring the amount of evaporation. The US National Weather Service class A pan is 4 ft in diameter, 10 in. deep, set up on a timber grillage so that the top rim is about 16 in. from the ground. The water level in the pan during the course of observation is maintained between 2 and 3 in. below the rim.

Evaporation, Total

The sum of water lost from a given land area during any specific time by transpiration from vegetation and building of plant tissue; by evaporation from water surfaces, moist soil, and snow; and by interception. It has been variously termed evaporation, evaporation from land areas, evapotranspiration, total loss, water losses, and fly off.

Evapotranspiration

Water withdrawn from a land area by evaporation from water surfaces and moist soils and plant transpiration.

Event-Based Model

A model that simulates some hydrologic response to a precipitation event. See continuous model.

Exceedance Probability

Hydrologically, the probability that an event selected at random will exceed a specified magnitude.

Excess Precipitation

The precipitation in excess of infiltration capacity, evaporation, transpiration, and other losses. Also referred to as effective precipitation.

Excessive Rainfall

See rainfall, excessive.

Falling Limb

The portion of a hydrograph where runoff is decreasing.

Field Capacity

The quantity of water which can be permanently retained in the soil in opposition to the downward pull of gravity. Also known as field-moisture capacity.

Field-Moisture Deficiency

The quantity of water which would be required to restore the soil moisture to field-moisture capacity.

Flood

An overflow or inundation that comes from a river or other body of water, and causes or threatens damage. Any relatively high streamflow overtopping the natural or artificial banks in any reach of a stream. A relatively high flow as measured by either gauge height or discharge quantity. As it relates to highway drainage design for TxDOT, and for the purposes of this manual, any direct runoff from precipitation; not limited to an out-of-banks event.

Flood Crest

See flood peak.

Flood Event

See flood wave.

Flood Peak

The highest value of the stage or discharge attained by a flood; thus, peak stage or peak discharge. Flood crest has nearly the same meaning, but since it connotes the top of the flood wave, it is properly used only in referring to stage—thus, crest stage, but not crest discharge.

Floodplain

A strip of relatively flat land bordering a stream, built of sediment carried by the stream and dropped in the slack water beyond the influence of the swiftest current. It is called a living flood plain if it is overflowed in times of high water; but a fossil flood plain if it is beyond the reach of the

highest flood. The lowland that borders a river, usually dry but subject to flooding. That land outside of a stream channel described by the perimeter of the maximum probable flood.

Flood Profile

A graph of elevation of the water surface of a river in flood, plotted as ordinate, against distance, measured in the downstream direction, plotted as abscissa. A flood profile may be drawn to show elevation at a given time, crests during a particular flood, or to show stages of concordant flows.

Flood Routing

The process of progressively determining the timing and shape of a flood wave at successive points along a river.

Flood Stage

The gauge height of the lowest bank of the reach in which the gauge is situated. The term "lowest bank" is, however, not to be taken to mean an unusually low place or break in the natural bank through which the water inundates an unimportant and small area. The stage at which overflow of the natural banks of a stream begins to occur. See also bankfull stage.

Flood Wave

A distinct rise in stage culminating in a crest and followed by recession to lower stages.

Flood, Maximum Probable

The flood magnitude that may be expected from the most critical combination of meteorologic and hydrologic conditions reasonably possible for a given watershed.

Flood-Frequency Curve

1. A graph showing the number of times per year on the average, plotted as abscissa, that floods of magnitude, indicated by the ordinate, are equaled or exceeded.
2. A similar graph but with recurrence intervals of floods plotted as abscissa.

Floodway

A part of the floodplain otherwise leveed, reserved for emergency diversion of water during floods. A part of the floodplain which, to facilitate the passage of floodwater, is kept clear of encumbrances.

The channel of a river or stream and those parts of the floodplains adjoining the channel which are reasonably required to carry and discharge the floodwater or floodflow of any river or stream.

Flow-Duration Curve

A cumulative frequency curve that shows the percentage of time that specified discharges are equaled or exceeded.

Gauging Station

A particular site on a stream, canal, lake, or reservoir where systematic observations of gauge height or discharge are obtained. (See also stream-gauging station.)

Ground Water

Water in the ground that is in the zone of saturation, from which wells, springs, and groundwater runoff are supplied.

Groundwater Outflow

That part of the discharge from a drainage basin that occurs through the ground water. The term "underflow" is often used to describe the groundwater outflow that takes place in valley alluvium (instead of the surface channel) and thus is not measured at a gauging station.

Groundwater Runoff

That part of the runoff that has passed into the ground, has become ground water, and has been discharged into a stream channel as spring or seepage water. See also base runoff and direct runoff.

Hydraulic Radius

The flow area of a channel cross section divided by the wetted perimeter. The wetted perimeter does not include the free surface.

Hydrograph

A graph showing stage, flow, velocity, or other property of water with respect to time.

Hydrologic Budget

An accounting of the inflow to, outflow from, and storage in a hydrologic unit, such as a drainage basin, aquifer, soil zone, lake, reservoir, or irrigation project.

Hydrologic Cycle

The continuous process of water movement between the oceans, atmosphere, and land.

Hydrology

The study of water; generally focuses on the distribution of water and interaction with the land surface and underlying soils and rocks.

Hyetograph

A plot of rainfall intensity versus time; often represented by a bar graph.

Index Precipitation

An index that can be used to adjust for bias in regional precipitation, often quantified as the expected annual precipitation.

Infiltration

The movement of water from the land surface into the soil.

Infiltration Capacity

The maximum rate at which the soil, when in a given condition, can absorb falling rain or melting snow.

Infiltration Index

An average rate of infiltration, in inches per hour, equal to the average rate of rainfall such that the volume of rainfall at greater rates equals the total direct runoff.

Inflection Point

Generally refers the point on a hydrograph separating the falling limb from the recession curve; any point on the hydrograph where the curve changes concavity.

Initial Condition

The conditions prevailing prior to an event. Refer also to antecedent conditions.

Interception

The capture of precipitation above the ground surface (e.g., by vegetation or buildings).

Isohyetal Line

A line drawn on a map or chart joining points that receive the same amount of precipitation.

Lag

Variably defined as time from beginning (or center of mass) of rainfall to peak (or center of mass) of a runoff hydrograph.

Lag Time

The time from the center of mass of excess rainfall to the hydrograph peak. Also referred to as basin lag.

Loss

The difference between the volume of rainfall and the volume of runoff. Losses include water absorbed by infiltration, water stored in surface depressions, and water intercepted by vegetation.

Mass Curve

A graph of the cumulative values of a hydrologic quantity (such as precipitation or runoff), generally as ordinate, plotted against time or date as abscissa. (See double-mass curve and residual-mass curve.)

Maximum Probable Flood

See flood, maximum probable.

Meander

The winding of a stream channel.

Model

A physical or mathematical representation of a process that can be used to predict some aspect of the process.

Moisture

Water diffused in the atmosphere or the ground.

Objective Function

A mathematical expression that allows comparison between a calculated result and a specified goal. For model calibration, the objective function compares calculated discharge with observed discharge.

Overland Flow

The shallow flow of water over the land surface before combining with additional flow to become channel flow.

Parameter

A variable, in a general model, whose value is adjusted to make the model specific to a given situation. A numerical measure of the properties of the real-world system.

Parameter Estimation

The selection of a parameter value based on the results of analysis and/or engineering judgment. Analysis techniques include calibration, regional analysis, estimating equations, and physically based methods. Refer also to calibration.

Partial-Duration Flood Series

A list of all flood peaks that exceed a chosen base stage or discharge, regardless of the number of peaks occurring in a year. (Also called basic-stage flood series, or floods above a base.)

Peak Flow

The point of the hydrograph that has the highest flow.

Peak Stage

The highest elevation reached by a flood wave. Also referred to as the crest.

Percolation

The movement, under hydrostatic pressure, of water through the interstices of a rock or soil.

PMF

Probable maximum flood; see flood, probable maximum.

Precipitation

As used in hydrology, precipitation is the discharge of water, in liquid or solid state, out of the atmosphere, generally upon a land or water surface. It is the common process by which atmospheric water becomes surface or subsurface water. The term precipitation is also commonly used to designate the quantity of water that is precipitated. Precipitation includes rainfall, snow, hail, and sleet, and is therefore a more general term than rainfall.

Precipitation, Probable Maximum

Theoretically the greatest depth of precipitation for a given duration that is physically possible over a given size storm area at a particular geographical location at a certain time of the year.

Probability of Capacity Exceedance

The likelihood of the design flow rate (or volume of water with specified duration) of a hydraulic structure being exceeded in a given year.

Probability of Exceedance

The likelihood of a specified flow rate (or volume of water with specified duration) being exceeded in a given year.

Rain

Liquid precipitation.

Rainfall

The quantity of water that falls as rain only. Not synonymous with precipitation.

Rainfall Excess

The volume of rainfall available for direct runoff. It is equal to the total rainfall minus interception, depression storage, and absorption.

Rating Curve

The relationship between stage and discharge.

Reach

A segment of a stream channel.

Recession Curve

The portion of the hydrograph where runoff is predominantly produced from basin storage (subsurface and small land depressions); it is separated from the falling limb of the hydrograph by an inflection point.

Recurrence Interval (return period)

The average interval of time within which the given flood will be equaled or exceeded once. When the recurrence interval is expressed in years, it is the reciprocal of the annual exceedance probability (AEP).

Regulation, Regulated

The artificial manipulation of the flow of a stream.

Reservoir

A pond, lake, or basin, either natural or artificial, for the storage, regulation, and control of water.

Residual-Mass Curve

A graph of the cumulative departures from a given reference such as the arithmetic average, generally as ordinate, plotted against time or date, as abscissa. (See mass curve.)

Retention Basin

Similar to detention basin but water in storage is permanently obstructed from flowing downstream.

Rising Limb

Portion of the hydrograph where runoff is increasing.

Runoff

Precipitation on the ground that is not captured by evaporation, infiltration, interception, or surface storage.

Saturation Zone

The portion of the soil profile where available water storage is completely filled. The boundary between the vadose zone and the saturation zone is called the water table. Note that under certain periods of infiltration, the uppermost layers of the soil profile can be saturated. See vadose zone.

NRCS Curve Number

An empirically derived relationship between location, soil-type, land use, antecedent moisture conditions, and runoff. A Natural Resources Conservation Service (NRCS) curve number is used in an event-based model to establish the initial soil moisture condition and the infiltration.

Snow

A form of precipitation composed of ice crystals.

Soil Moisture Accounting (SMA)

A modeling process that accounts for continuous fluxes to and from the soil profile. Models can be event-based or continuous. When using a continuous simulation, a soil moisture accounting method is used to account for changes in soil moisture between precipitation events.

Soil Moisture (soil water)

Water diffused in the soil, the upper part of the zone of aeration from which water is discharged by the transpiration of plants or by soil evaporation. See field-moisture capacity and field-moisture deficiency.

Soil Profile

A description of the uppermost layers of the ground down to bedrock. In a hydrologic context, the portion of the ground subject to infiltration, evaporation, and percolation fluxes.

Stage

The height of a water surface in relation to a datum.

Stage-Capacity Curve

A graph showing the relation between the surface elevation of the water in a reservoir usually plotted as ordinate, against the volume below that elevation plotted as abscissa.

Stage-Discharge Curve (rating curve)

A graph showing the relation between the water height, usually plotted as ordinate, and the amount of water flowing in a channel, expressed as volume per unit of time, plotted as abscissa.

Stage-Discharge Relation

The relation expressed by the stage-discharge curve.

Stemflow

Rainfall or snowmelt led to the ground down the trunks or stems of plants.

Storage

1. Water artificially or naturally impounded in surface or underground reservoirs. The term regulation refers to the action of this storage in modifying downstream streamflow.
2. Water naturally detained in a drainage basin, such as ground water, channel storage, and depression storage. The term drainage basin storage or simply basin storage is sometimes used to refer collectively to the amount of water in natural storage in a drainage basin.

Storm

A disturbance of the ordinary average conditions of the atmosphere which, unless specifically qualified, may include any or all meteorological disturbances, such as wind, rain, snow, hail, or thunder.

Stream

A general term for a body of flowing water. In hydrology the term is generally applied to the water flowing in a natural channel as distinct from a canal. More generally, as in the term stream gauging, it is applied to the water flowing in any channel, natural or artificial.

Stream Gauging

The process of measuring the depths, areas, velocities, and rates of flow in natural or artificial channels.

Streamflow

The discharge that occurs in a natural channel. Although the term discharge can be applied to the flow of a canal, the word streamflow uniquely describes the discharge in a surface stream course. The term streamflow is more general than runoff, as streamflow may be applied to discharge whether or not it is affected by diversion or regulation.

Stream-Gauging Station

A gauging station where a record of discharge of a stream is obtained. Within the USGS this term is used only for those gauging stations where a continuous record of discharge is obtained.

Sublimation

The process of transformation directly between a solid and a gas.

Surface Runoff

That part of the runoff that travels over the soil surface to the nearest stream channel. It is also defined as that part of the runoff of a drainage basin that has not passed beneath the surface since precipitation. The term is misused when applied in the sense of direct runoff. See also runoff, overland flow, direct runoff, groundwater runoff, and surface water.

Surface Water

Water on the surface of the earth.

Tension Zone

In the context of HEC-HMS, the portion of the soil profile that will lose water only to evapotranspiration. This designation allows modeling water held in the interstices of the soil. See soil profile.

Time of Concentration

The travel time from the hydraulically furthestmost point in a watershed to the outlet. Also defined as the time from the end of rainfall excess to the inflection point on the recession curve.

Time of Rise

The time from the start of rainfall excess to the peak of the hydrograph.

Time to Peak

The time from the center of mass of the rainfall excess to the peak of the hydrograph. Refer also to lag time

TR-20

Computer program developed by the NRCS that provides a hydrologic analysis of a watershed under present conditions. Output consists of peaks and/or flood hydrographs. Subarea surface runoff hydrographs are developed from storm rainfall using the dimensionless unit hydrograph, drainage areas, times of concentration, and NRCS runoff curve numbers. Instructions to develop, route, add, store, divert, or divide hydrographs are established to convey floodwater from the headwaters to the watershed outlet.

TR-55

Urban Hydrology for Small Watershed—Technical Release 55 published by the NRCS. Technical Release 55 (TR-55) presents simplified procedures to calculate storm runoff volume, peak rate of discharge, hydrographs, and storage volumes required for floodwater reservoirs. These procedures are applicable to small watersheds, especially urbanizing watersheds, in the United States.

Transpiration

The quantity of water absorbed and transpired and used directly in the building of plant tissue, in a specified time. It does not include soil evaporation. The process by which water vapor escapes from the living plant, principally the leaves, and enters the atmosphere.

Underflow

The downstream flow of water through the permeable deposits that underlie a stream and that are more or less limited by rocks of low permeability.

Unit Hydrograph

A direct runoff hydrograph produced by 1 unit of excess precipitation over a specified duration. For example, a 1-hour unit hydrograph is the direct runoff from one unit of excess precipitation occurring uniformly over one hour.

Vadose Zone

The portion of the soil profile above the saturation zone.

Water Year

In USGS reports dealing with surface-water supply, the 12-month period, October 1 through September 30. The water year is designated by the calendar year in which it ends and which includes 9 of the 12 months. Thus, the year ended September 30, 1959, is called the 1959 water year.

Watershed

An area characterized by all direct runoff being conveyed to the same outlet. Similar terms include basin, drainage basin, catchment, and catch basin.

A part of the surface of the earth that is occupied by a drainage system, which consists of a surface stream or a body of impounded surface water together with all tributary surface streams and bodies of impounded surface water.

WinTR-55

A MS Windows-based computer program developed by NRCS. WinTR-55 uses the procedures presented in TR-20 as the driving engine for more accurate analysis of the hydrology of the small watershed system being studied.

Chapter 5 — NFIP Design of Floodplain Encroachments & Cross Drainage Structures

Contents:

[Section 1 — The National Flood Insurance Program \(NFIP\)](#)

[Section 2 — Definitions](#)

[Section 3 — NFIP Roles](#)

[Section 4 — TxDOT and the NFIP](#)

[Section 5 — Hydrologic and Hydraulic Studies](#)

[Section 6 — Hydrologic and Hydraulic Results](#)

Section 1 — The National Flood Insurance Program (NFIP)

The roadway and drainage facility designers, whether TxDOT or consultant, need to consider flood issues, and be familiar with the intent and requirements of the Federal Emergency Management Agency (FEMA) NFIP.

The NFIP was established by the United States Congress in the National Flood Insurance Act of 1968 (42 U.S.C. 4001 et seq.) and is administered by the Federal Insurance Administration and the Mitigation Directorate of FEMA. Flooding may be from marine, lacustrine, or riverine sources.

The purpose and intent of the NFIP is to discourage development within the floodplain that will increase the risk of loss from flood damage, and to encourage suitable use of floodplains. Parks, playfields, roads, bridges, and culverts are consistent with suitable use of floodplains when properly designed and constructed.

Section 2 — Definitions

Floodplain encroachment, as it applies to TxDOT, is any construction, replacement, or extension of a bridge, culvert, low-water crossing, or storm drain outfall in a floodplain whether the structure interferes with flood waters or not. Encroachments can also be bridge widening, pavement overlays, modification or addition of bridge rails and traffic median barriers, and safety end treatments (SETs). Longitudinal encroachments are roads or walkways constructed in the floodplain paralleling a watercourse instead of crossing it. TxDOT has extended the definition of encroachment to include structures over any [waters of the U.S.](#), whether in a FEMA mapped floodplain or not.

Minor structures are smaller culverts under driveways in ditches or under the roadway connecting two ditches, but not conveying waters of the U.S.

Mapped Floodplain or Special Flood Hazard Area (SFHA) is an area that FEMA has designated as having a probability of inundation during a 1% AEP (Annual Exceedance Probability) or 100-year flood, usually shown on a Flood Insurance Rate Map (FIRM). Most of the mapped floodplains or SFHAs are riverine designated Zone A, AE, or A1-30; other types are playas (AH), flatlands with standing waters (AO), and coastal floodplains, (V, VE, or V1-30). The accepted definitions of various risk zones, including SFHAs, are listed below (see Types of Flood Zones).

Flood Insurance Rate Map (FIRM) is a graphical representation of SFHAs and floodways, flood hazard risk zones, base flood elevations, 0.2% AEP (500-year) floodplain areas, and other flood-related information.

Effective Map is the latest FIRM issued by FEMA, which is in effect as of the date shown in the title box of the FIRM as "Effective Date," "Revised," or "Map Revised."

Base Flood Elevation (BFE) is the 1% AEP flood water surface elevation. BFEs are usually given in feet above mean sea level. BFEs are determined through a hydrologic and hydraulic study of the area or the waterway as a whole, not a small area or isolated reach of stream.

Flood Insurance Study (FIS) is the final report which summarizes the results of the detailed studies on which a Zone AE is based. The FIS usually includes an appraisal of a community's flooding problems, engineering methodologies, flood discharges, flood profiles, and floodplain/floodway technical data.

Floodway is the channel of a river or other watercourse and the adjacent land areas that must be reserved in order to discharge the base flood without increasing the water-surface elevation more than a designated height.

Flood fringe is the area within the floodplain but outside of the floodway.

Types of Flood Zones (Risk Flood Insurance Zone Designations)

ZONE A: SFHAs inundated by the 1% AEP (100-year) flood. No BFEs determined.

ZONE AE (formerly A1-30): SFHAs inundated by the 1% AEP (100-year) flood. BFEs determined by detailed study.

ZONE AO: SFHAs inundated by 1% AEP (100-year) flood depths of 1 to 3 feet, usually sheet flow on sloping terrain. Depths shown are average. For areas of alluvial fan flooding, velocities are also determined. See 44CFR59, "[Area of shallow flooding](#)".

ZONE AH: SFHAs inundated by 1% AEP (100-year) flood depths of 1 to 3 feet, usually areas of ponding. BFEs are determined. In Texas, Zone AH usually applies to playas, low areas with no outflow. The only escapes are infiltration and evaporation.

ZONE AR: SFHAs that result from the decertification of previously accredited flood protection systems that are in the process of being restored to provide a 1% AEP (100-year) or greater level of flood protection.

ZONES AR/A1-30, AR/AE, AR/AH, AR/AO and AR/A (Dual Zones): SFHAs that result from the decertification of previously accredited flood protection systems that are in the process of being restored to provide a 1% AEP (100-year) or greater level of flood protection. After restoration is complete, these areas will still experience residual flooding from other flooding sources.

ZONE A99: SFHAs inundated by the 1% AEP (100-year) flood to be protected from the 1% AEP flood by a Federal flood protection system under construction. No BFEs determined.

ZONE V: SFHAs in coastal areas with velocity hazards (wave action) inundated by the 1% AEP (100-year) flood; no BFEs determined.

ZONE VE (formerly V1-30): SFHAs in coastal areas with velocity hazards (wave action) inundated by the 1% AEP (100-year) flood. Base flood elevations determined by detailed study.

ZONE B and ZONE X (shaded): Areas of 0.2% AEP (500-year) flood; areas subject to the 1% AEP (100-year) flood with average depths of less than 1 foot or with contributing drainage area less than 1 square mile; areas protected by levees from the base flood.

ZONE C and ZONE X (unshaded): Areas determined to be outside the 0.2% AEP (500-year) floodplain.

ZONE D: Areas in which flood hazards are undetermined.

Section 3 — NFIP Roles

Participation

Participation in the NFIP is voluntary and most communities participate, although not all communities choose to. A community must be a participating community in the NFIP in order to have valid FEMA mapped SFHAs within it. A community must agree to regulate new development in the designated floodplain through a floodplain ordinance to participate in the NFIP. For the purposes of the NFIP, [44CFR78.2](#) defines community as (1) a political subdivision that has zoning and building code jurisdiction over a particular area having special flood hazards or participating in the NFIP, or (2) a political subdivision of a State or other authority that is designated to develop and administer a mitigation plan by political subdivision. In other words, a community is an entity which has authority to adopt and enforce floodplain management regulations for the areas within its jurisdiction.

The floodplain ordinance must require that development in the designated floodplain be consistent with the intent, standards and criteria set by the NFIP. Communities may adopt ordinances and rules that are more stringent than the requirements in [44CFR60.3](#) and are encouraged by FEMA to do so. In return for community participation in the NFIP, the property owners in the community are eligible to purchase federal flood insurance for buildings and contents, and FEMA will prepare maps showing the SFHAs to be used by the community, insurance agents, and others. FEMA maintains the list of all [NFIP communities](#) within the states, both participating and non-participating.

Floodplain Administrator

A participating community is required to appoint a Floodplain Administrator (FPA) whose duty is enforcement of the floodplain ordinance by permitting activities in the SFHAs and maintaining records of all changes to the water surface elevations in the SFHAs.

Texas

FEMA requires each state to appoint a State Coordinating Agency for the NFIP, which in Texas is the Texas Water Development Board (TWDB). The [Texas Water Code](#) (TWC 16.3145) requires all cities and counties to adopt ordinances making them eligible to participate in the NFIP. However, actual participation is at the option of the community.

Non-participating Communities

Not all communities are participating in the NFIP. Some communities have never participated while others were mapped but then withdrew from the program. The FIRMs of the withdrawn communities still exist and are available online even though they are not effective maps.

A community must be a participating community in the NFIP in order to have valid FEMA mapped SFHAs within it. Communities not participating in the NFIP do not have any valid FEMA mapped SFHAs by virtue of the fact that they are non-participating, even though FEMA flood maps may exist.

FEMA issues a community identification number (CID) to every community including non-participating ones. However, FEMA has not issued a CID to any State. Without a CID, a State can not be a participating community in the NFIP, therefore a FEMA mapped SFHA cannot exist on state owned lands and public rights of way (ROW), and the State cannot be held to the requirements of 44CFR60.

Section 4 — TxDOT and the NFIP

Texas and the NFIP

Texas as a State is a non-participating community within the NFIP, and TxDOT is an entity agency of the State of Texas. Therefore, the requirements of 44CFR60 do not apply to TxDOT and no SFHAs exist on TxDOT ROW. A TxDOT office may choose to assist an FPA within the office's ability, but a community's floodplain requirements are not binding on TxDOT because TxDOT is an agency of the State of Texas. The FPA may request or advise certain elements in the project design, but has no approval authority over TxDOT project design or placement.

A FIRM may show a TxDOT ROW crossing a community's FEMA mapped SFHA, but in fact the community's SFHA stops at one ROW line and continues after the other ROW line. Even if the ROW is within the limits of a municipality or a county, the TxDOT ROW is actually property of the State of Texas and is therefore "outside" of the municipality or county. The situation is analogous to a stream passing out of a municipality's corporate limits into a non-participating community and back into the participating community. Actions in the non-participating community do not fall under the purview of 44CFR60.

As mentioned in NFIP Roles: Participation, FEMA encourages communities to adopt ordinances and rules that are more stringent than the minimum (i.e. stricter criteria). These more restrictive technical criteria present a problem of equitable funding of projects among all communities. TxDOT cannot favor one community over another simply because one community has stricter criteria than the other community. A TxDOT office may choose to assist a local FPA within the office's ability, but a local community's floodplain requirements are not binding on TxDOT. There are instances where the local stricter criteria do not place a hardship on TxDOT. For example, there are times where TxDOT criteria call for a 2% AEP (50-year) bridge and the 1% AEP water surface coincidentally falls within the available freeboard. This is still considered a 2% AEP bridge, yet it can also be considered to meet a request for a bridge to pass the 1% AEP flow.

TxDOT and Local Floodplain Regulations

Texas Attorneys General have ruled in a series of opinions [JM-117(1983); C-690(1966); JM-1035(1989)] that state agencies are prohibited from applying for permits from subordinate jurisdictions. Although the opinions were written originally to address the issue of electrical utilities and cities attempting to require TxDOT contractors to apply for permits for roadway illumination installations, the opinion applies equally to community floodplain permit requirements. A court decision speaking to this concept is *City of Houston v. Houston ISD*, 436 S.W. 2ND 568, at 572, "Properties of the State are excluded as a matter of law from the application of City building regulations."

Permits versus FPA Notification

FPA's normally require permits for any work in the mapped floodplain in order to prevent any improper development and to track all activity and changes which will affect the floodplain. TxDOT recognizes that activities such as bridge and culvert construction or roadway overlays can have an effect on the floodplain, and that the FPA needs the information. Since TxDOT cannot apply for a permit, as discussed in "TxDOT and Local Floodplain Regulations," TxDOT requires the designing office to send a copy of the plan set along with any and all supporting hydrologic and hydraulic computations and program files to the local FPA. (See FPA Notification Details.) The designer should place a note on the hydrologic plan sheet stating, "H&H files were sent to the local Floodplain Administrator _____ name _____ on _____ date _____." The date is the date the documents, plans, and files are sent to the local FPA.

Hydraulic Structures versus Insurable Structures

One source of confusion for the communities is 44CFR 60, Subpart B (section [60.11 - 13](#)) titled Requirements for State Flood Plain Management Regulations, which applies to structures on State owned properties. Structure is defined in [44CFR59.1](#) as a walled, roofed building. Hydraulic structures such as bridges, culverts, and storm drains are neither included nor considered because for the purpose of the NFIP they are not insurable structures. Subpart B does apply to TxDOT office buildings, maintenance or repair shops, and highway rest area facilities.

Off System Structures

Bridges and culverts that belong to a county or municipality are not on the TxDOT ROW and are therefore within a community's floodplain. The FPA may attempt to require a permit from TxDOT when TxDOT controls or oversees the funds used to repair or replace structures in the community's floodplain. The community is responsible for any permits because the structure belongs to the community,. In this situation, TxDOT is acting on the behalf of the community as its consultant. Just as the community would not require a consulting firm it hired to obtain and be responsible for the permits, the community can not hold TxDOT responsible for these same permits.

Liability

TxDOT project engineers and contract managers should understand that compliance with the NFIP and coordination with the FPA does not relieve TxDOT of the requirements of civil law. The Texas Water Code section 11.086 prohibits diversion or impoundment which will harm another property. Roadway and bridge designers must pay attention to surrounding conditions of building placements, property access, and runoff patterns to assure that the project will not cause adverse impacts to adjacent properties. Every designer for TxDOT has an obligation not to put TxDOT in a position of liability due to their design.

The need for documentation that supports and protects TxDOT from lawsuits or liability claims is the reason for the inclusion of the required hydrologic and hydraulic study details in the plan set as engineering documents on sealed sheets.

Section 5 — Hydrologic and Hydraulic Studies

Before starting the design

The roadway designer should visit the site to observe existing conditions and limitations. The designer must avoid designs that may cause increased flooding or increased damage to adjacent, downstream, or upstream properties. TxDOT can be held liable for damages even if a design only increases the frequency of flooding to properties that are already regularly inundated. Overlays in areas where the water overtops the roadway may require milling prior to resurfacing in order to maintain the same elevation and not increase flooding. Problems caused by culverts and bridges can usually be avoided by alternative designs that will not significantly increase the cost. Ultimately, TxDOT must not be perceived as causing flooding to adjacent, downstream, or upstream property owners.

If the project is within a participating community

The designer should contact the local FPA. The FPA can be a source of valuable data to aid in the hydraulic design, such as existing flooding issues that the project may exacerbate if unaddressed or may alleviate with minor modification to the project. The FPA may have information or a localized study establishing an approximate BFE for Zone A, or may have the complete study data used to establish BFEs for the entire zone. The FPA may also have knowledge of a [CLOMR](#) submitted to FEMA by others, or other changes to the area.

If the project is within or crossing an SFHA

The designer should determine the SFHA zone designation with the current, correct FIRM. The FIRMs are available at www.msc.fema.gov. Locate the project site on the FIRM to determine whether it crosses or is in any SFHAs Zoned A, AE (A1-30), AO, AH, V, or VE (V1-30). Actions for the various SFHAs are as follows:

- ◆ **Zone A** - No BFE or only an approximate BFE is available. A full hydrologic and hydraulic analysis and coordination with the local FPA is required regardless of results (rise, no rise or lowering of the BFE). Any rise in the BFE which extends beyond the project ROW requires discussion with the FPA to make sure the rise is acceptable. The rise must not cause damage to properties in order to be acceptable. The FPA may also be able to use the TxDOT hydrologic and hydraulic analysis to establish informal BFEs in that area.

The designer should compare the flood footprint from the design hydraulic analysis with the FIRM Zone A footprint, and explore any serious discrepancies.

- ◆ **Zone AE** - BFE's have been established by formal hydrologic and hydraulic study. The steps in analyzing a Zone AE are as follows:

A.

1. **Existing Model:** The designer is required to obtain from the FPA or FEMA the effective hydraulic model or study data to use for the analysis. Consult DES-HYD for instructions on ordering the model data. If no model is available, go to **B** below. The entire length of the model usually does not need to be used; the designer should select the appropriate reach for the analysis. However, the selected reach shall fit seamlessly into the entire model; that is, water surface elevations and velocities must match exactly at both the downstream and upstream ends of the selected reach.

2. **Updated Model (if necessary):** Older studies that were modeled in HEC-2, WSPRO, or some other program should be converted to HEC-RAS. Corrections to the model must be made because of differences in modeling practices, such as the tendency of piers to be modeled as ground points in HEC-2. Differences in programmed algorithms within the software will cause differences in the water surface elevations. The reasons for the differences are explained in detail in a memorandum from FEMA dated April 30, 2001, titled "[Policy for use of HEC-RAS in the NFIP](#)." FEMA requires that the revised and unrevised BFEs match within 0.5 foot at the bounding cross sections between the output of the older model and HEC-RAS model ([44 CFR 65.6\(a\)\(2\)](#)).

3. **Corrected Existing Model:** The designer should examine the effective (or updated) hydraulic model for errors such as unrealistic or incorrect flows (Q), inaccurate survey data, missing bridges, and bridges where hydraulically inefficient rails were excluded in the model. The model should be labeled "corrected effective" after the corrections have been made. The water surface elevations in the corrected effective model may be higher or lower than in the existing effective model, but the designer has no requirement to file a [CLOMR/LOMR](#) other than supplying the FPA with a copy of the corrected model.

4. **Proposed Model:** The designer should then utilize the corrected effective hydraulic model to include the new structure. The model should be labeled "proposed".

B.

Sometimes the effective hydraulic model or its data are not available, or the data are unreadable and therefore unusable. In such situations, a new complete HEC-RAS model to approximate the current model must be developed as follows:

1. The designer must obtain any available information from the FIS and FIRM, such as flow-rate(s), cross section topography, floodplain footprint, and BFE's at pertinent cross-sections.
2. The designer must use the available information to develop a hydraulic model as if a Zone AE was not present.
3. In a Zone AE without a floodway, the designer must compare the output from the new HEC-RAS model with the published BFE's from the FIS and the floodplain footprint from the FIRM. The model must match the published BFEs within 0.10 foot. If only the FIRM is avail-

able or if the FIS has no BFEs listed, the model must match the BFEs on the FIRM to 0.5 foot or less.

4. In a Zone AE with a floodway, flow should be confined to the floodway limits and the elevations match the published floodway elevations to within 0.10 foot (23 CFR 650A, Attach 2).

5. Once the new HEC-RAS model meets the allowable differences, the model should be labeled "replacement effective" model and steps A1 through A4 above should be used to progress toward a "proposed" model.

If the FEMA data or model is not used, the situation and process must be fully explained in the hydrologic and hydraulic report and noted on the plan sheet. The argument that the hydraulic data is only available in hard copy and must be manually entered is not an acceptable explanation for not using the FEMA model.

On occasion, a model is obtained which contains numerous errors throughout the entire reach. TxDOT is not responsible for quality control and comprehensive updating of the NFIP models. In these cases, either limit the reach used for the TxDOT study to the shortest length practical, limit the corrections to the cross-sections closest to the bridge, or both. Consult the DES-HYD if a corrected or updated hydraulic model appears to be warranted.

If the flowrates used in the existing model appear to be in error, the designer is encouraged to develop a new hydrologic model and compare the results. If the existing flowrates are not used, the justification must be explained in the hydrologic and hydraulic report and noted on the plan sheet. The hydrologic process must also be included in the report. Designers shall not, in any circumstance, develop a new model without documented justification.

- ◆ **Zone AE with Regulatory Floodway** - Once a regulatory floodway, or floodway, has been determined and mapped on a FIRM, FEMA requires a study to prove no rise of the water surface for any work in a floodway. The designer must obtain the floodway model to determine the limits of the floodway and the effect of the proposed structure on the floodway. The floodway model is not to be confused with the current effective floodplain model. The floodway model is almost identical to the floodplain model with the exception that it contains the floodway boundaries. This model should be obtained along with the floodplain model.

If the entire structure of a bridge, including abutments, bridge superstructure and piers, can be documented to be well outside the limits of a regulatory floodway, and is above the BFE in the floodway, then the current effective hydraulic model may not need to be obtained. The NFIP allows that any work, including fill, in the flood fringe or above the floodway does not require a study because the study establishing the regulatory floodway assumed that the flood fringe was already filled. If the bridge design meets these criteria, the normally required analysis can be replaced by a prominently placed note in the plans. However, if there are insurable structures in the floodplain, TxDOT requires that the roadway designer acquire and modify the floodplain model as outlined in **Zone AE** above.

- ◆ **Zone AH** - Places of no outflow, such as playas, in which the BFE has been determined are labeled Zone AH. Structures in playas are equalizers and as such, the bridges and culverts typically need no hydraulic modeling. However, the designer is required to calculate how much the BFE will be raised because the roadway and structure will reduce storage in the playa if any roadway work will be in the Zone AH and below the BFE.
- ◆ **Zone AO** - Average flood depths are given instead of a flood elevation. The designer should examine the source of the flooding to make sure the project will not trap flood waters or block drainage. The design may require relief structures in any elevated roadway or extended bridge approaches.
- ◆ **Coastal Zones V, VE (V1-30), A, and AE** - Coastal zones are flooded by the Gulf of Mexico storm waters instead of riverine flows. The FEMA modeling for coastal zones is not the same as for riverine modeling. The designer does not need to acquire the model but must consider tidal flows, wave actions, and storm precipitation. The designer should make sure the project will not trap flood waters or block drainage.

High Bridges

For some bridges, the geometry is such that the bridge either spans the entire floodplain or the low chord is well above the BFE. In these situations, or where the proposed work can be documented to be well above the BFE and outside the limits of the floodplain, a hydraulic analysis may not be necessary. The normally required analysis can be replaced by a prominently placed note in the plans.



Figure 5-1. Fred Hartman Bridge facing Baytown from the ship channel, mostly above the BFE.

Section 6 — Hydrologic and Hydraulic Results

Changes to the BFE

Repair, extension, or replacement of any particular bridge or culvert may cause the BFE to be raised, lowered, or not changed at all. Lowering the water surface elevation usually doesn't cause any adverse impacts, but the site should be visited to confirm that there will be no resulting problems. Many bridge replacements result in a lowered water surface elevation because of reduced pier sets, enlarged openings, raised low chords, or improved channels.

Raising the water surface elevation requires examination of the adjacent properties to assure that the change will not cause any adverse impacts. A rise usually can be considered as having no impact if the rise is contained within the TxDOT ROW. A rise which extends outside of the ROW may be considered either insignificant or significant. A severe rise in an uninhabited area, not excessively flooding adjacent properties, not damaging the stream banks, and not blocking access to properties might be considered insignificant. A rise in an urban area that is contained within the banks without damage to the stream banks or back flooding the sewers may also be considered insignificant. However, in each situation, the effects have to be examined at the site to confirm that the rises are insignificant.

Range of Frequencies

The NFIP only considers the 1% AEP. However, the designer should analyze the effect of a proposed structure on the full range of AEP water surface elevations (the 50%, 20%, 10%, 4%, and 2% as well as the 1% AEP). The proposed structure may not cause any problem at the design AEP flow, but may cause a problem at one of the other frequencies. Analyzing only for the 1% and design AEP flows may fail to reveal these problems. See [Liability](#) above.

Some FEMA models contain only the 1% AEP. The designer will need to develop the full range of flows (50%, 20%, 10%, 4%, and 2% AEP) using a suitable method.

Conditional Letter Of Map Revision (CLOMR)/Letter Of Map Revision (LOMR)

Changes to the water surface elevation in studied areas are usually reported to FEMA by submission of a CLOMR and LOMR. A CLOMR, if required, is submitted to FEMA prior to initiating work to receive approval for the project design and the impacts on the floodplain; a LOMR is submitted after the project has been completed. The approval of a CLOMR application by FEMA requires significant time (six to 12 months), which needs to be factored into the required design time to prevent delay of the project letting.

A community may attempt to require TxDOT to submit a CLOMR and a LOMR, based on a 44CFR 60.3 requirement for participating communities to notify FEMA of all changes to the BFE. However, the requirement does not apply to TxDOT because the State of Texas is not a participating community in the NFIP, as discussed above. Additionally, [Non-regulatory Supplement 23 CFR 650A, Attachment 2](#) states in the first paragraph, "The community, by necessity, is the one who must submit proposals to FEMA for amendments to NFIP ordinances and maps in that community should it be necessary." See also [Permit versus FPA Notification](#). TxDOT provides the technical data to the FPA, as required in 44CFR 60.3, through FPA Notification to enable the FPA to submit it to FEMA.

TxDOT will prepare and submit a CLOMR/LOMR for very few situations, as described below. This is more likely to happen on large projects which involve major changes to the floodplain, such as channel realignment or channel restoration. However, the designer must consult the DES-HYD before proceeding with the CLOMR/LOMR process.

ALL CLOMRS MUST BE REVIEWED BY DES-HYD BEFORE SUBMITTAL TO THE FPA.

A CLOMR may be prepared and submitted in the following limited circumstances:

TxDOT will not file a CLOMR to better define the floodplain for projects in a Zone A. TxDOT will not file a CLOMR to redefine a Zone AE where TxDOT improvements drop the water surface elevation of the BFE, or otherwise change the floodplain footprint, so as to encourage additional development. Improvements in the floodplain that may result from TxDOT projects are considered incidental. However, as for any project, TxDOT will still provide its plans and studies in these cases for the community records.

- ◆ An encroachment on a floodway of a SFHA results in a rise (not contained within the TxDOT ROW) of the base flood elevation in a Zone AE with Floodway. Alternatively, a larger bridge or culvert may be preferable.
- ◆ Increases in water surface elevations (not contained within the TxDOT ROW) exceed the usually available (or remainder of) a cumulative 1-foot rise in a Zone AE. Alternatively, a larger bridge or culvert may be preferable.
- ◆ An increase in water surface elevation (not contained within the TxDOT ROW) results in a significant increase of the horizontal extent of the floodplain footprint in unusually flat areas and in a Zone AE. Alternatively, a larger bridge or culvert may be preferable.
- ◆ A major channel relocation in a Zone AE that is outside the TxDOT ROW.
- ◆ Where a relief structure is outside the SFHA containing the main structure and a risk exists of development immediately downstream of the relief structure that might interfere with the operation of the relief structure. Alternatively, a larger main structure may be preferable.

TxDOT will not file a CLOMR to better define the floodplain for projects in a Zone A. TxDOT will not file a CLOMR to redefine a Zone AE where TxDOT improvements drop the water surface

elevation of the BFE, or otherwise change the floodplain footprint, so as to encourage additional development. Improvements in the floodplain that may result from TxDOT projects are considered incidental. However, as for any project, TxDOT will still provide its plans and studies in these cases for the community records.

FPA Notification Details

The TxDOT office where the plans are being developed shall forward a copy of the plan sheets along with all hydrologic and hydraulic analyses, reports, and electronic copies of the models to the local FPA, or FPAs if more than one community is involved. FPA Notification is required no later than when the project is submitted for letting but should be accomplished as soon as the hydraulic design is complete. The purpose of the FPA Notification is to document to the FPA any changes or non-changes to the BFE. The submitted FPA Notification must be complete enough for the community to apply for a Letter of Map Revision (LOMR) if the local FPA deems it necessary.

The transmittal letter to the FPA should state that the attached information is being sent for the FPA's floodplain records. It must not ask for the FPA's concurrence, approval, or consent. The FPA has no authority to approve, disapprove, or change the modeling or design but may offer valuable guidance to the designer.

The designer should be aware that, while the designer's office is coordinating with a community, it does not mean that the office is automatically coordinating with the FPA. The FPA may be in a completely different department such as Health, and not Engineering. This is a source of confusion, and may result in a project having problems if the FPA is not involved until late in the design. The designer should verify that the FPA is involved and recommend to the community engineer that the local FPA be involved early in the design process.

Communities Without an FPA

A community which is not participating in the NFIP does not have an FPA. The FPA Notification documentation should be sent to the county engineer or county judge, if in an unincorporated area, or the municipal engineer if in an incorporated non-participating city, town, village, tribe, or municipal utility district (MUD). By coordinating with the community, TxDOT may prevent public concerns from growing into problems, and may raise the awareness of flood issues within the community.

Chapter 6 — Hydraulic Principles

Contents:

[Section 1 — Open Channel Flow](#)

[Section 2 — Flow in Conduits](#)

[Section 3 — Hydraulic Grade Line Analysis](#)

Section 1 — Open Channel Flow

Introduction

This chapter describes concepts and equations that apply to the design or analysis of open channels and conduit for culverts and storm drains. Refer to the relevant chapters for specific procedures.

Continuity and Velocity

The continuity equation is the statement of conservation of mass in fluid mechanics. For the special case of steady flow of an incompressible fluid, it assumes the following form:

$$Q = A_1 v_1 = A_2 v_2$$

Equation 6-1.

where:

Q = discharge (cfs or m³/s)

A = flow cross-sectional area (sq. ft. or m²)

v = mean cross-sectional velocity (fps or m/s, perpendicular to the flow area).

The superscripts *1* and *2* refer to successive cross sections along the flow path.

As indicated by the Continuity Equation, the average velocity in a channel cross-section, (v) is the total discharge divided by the cross-sectional area of flow perpendicular to the cross-section. It is only a general indicator and does not reflect the horizontal and vertical variation in velocity.

Velocity varies horizontally and vertically across a section. Velocities near the ground approach zero. Highest velocities typically occur some depth below the water surface near the station where the deepest flow exists. For one-dimensional analysis techniques such as the [Slope Conveyance Method](#) and [\(Standard\) Step Backwater Method](#) (see Chapter 7), ignore the vertical distribution, and estimate the horizontal velocity distribution by subdividing the channel cross section and computing average velocities for each subsection. The resulting velocities represent a velocity distribution.

Channel Capacity

Most of the departmental channel analysis procedures use the Manning's Equation for uniform flow (Equation 6-2) as a basis for analysis:

$$v = \frac{z}{n} R^{2/3} S^{1/2}$$

Equation 6-2.

where:

v = Velocity in cfs or m^3/sec

z = 1.486 for English measurement units, and 1.0 for metric

n = Manning's roughness coefficient (a coefficient for quantifying the roughness characteristics of the channel)

R = hydraulic radius (ft. or m) = A / WP

WP = wetted perimeter of flow (the length of the channel boundary in direct contact with the water) (ft. or m)

S = slope of the energy gradeline (ft./ft. or m/m) (For uniform, steady flow, S = channel slope, ft./ft. or m/m).

Combine Manning's Equation with the continuity equation to determine the channel uniform flow capacity as shown in Equation 6-3.

$$Q = \frac{z}{n} A R^{2/3} S^{1/2}$$

Equation 6-3.

where:

Q = discharge (cfs or m^3/s)

z = 1.486 for English measurement units, and 1.0 for metric

A = cross-sectional area of flow (sq. ft. or m^2).

For convenience, Manning's Equation in this manual assumes the form of Equation 6-3. Since Manning's Equation does not allow a direct solution to water depth (given discharge, longitudinal slope, roughness characteristics, and channel dimensions), an indirect solution to channel flow is necessary. This is accomplished by developing a stage-discharge relationship for flow in the stream.

All conventional procedures for developing the stage-discharge relationship include certain basic parameters as follows:

- ◆ geometric descriptions of [typical cross section](#)
- ◆ identification and quantification of stream [roughness characteristics](#)
- ◆ a longitudinal water surface slope.

You need careful consideration to make an appropriate selection and estimation of these parameters.

Conveyance

In channel analysis, it is often convenient to group the channel cross-sectional properties in a single term called the channel conveyance (K), shown in Equation 6-4.

$$K = \frac{Z}{n} A R^{2/3}$$

Equation 6-4.

Manning's Equation can then be written as:

$$Q = K S^{1/2}$$

Equation 6-5.

Conveyance is useful when computing the distribution of overbank flood flows in the cross section and the flow distribution through the opening in a proposed stream crossing.

Energy Equations

Assuming channel slopes of less than 10 percent, the total energy head can be shown as Equation 6-6.

$$H = \frac{P}{\gamma_w} + z + \alpha \frac{v^2}{2g}$$

Equation 6-6.

where:

H = total energy head (ft. or m)

P = pressure (lb./sq.ft. or N/m²)

γ_w = unit weight of water (62.4 lb./cu.ft. or 9810 N/m³)

z = elevation head (ft. or m)

$\frac{v^2}{2g}$ = average velocity head, h_v (ft. or m)

g = gravitational acceleration (32.2 ft./s² or 9.81 m/s²)

α = kinetic energy coefficient, as described in [Kinetic Energy Coefficient Computation](#) section

v = mean velocity (fps or m/s).

In open channel computations, it is often useful to define the total energy head as the sum of the specific energy head and the elevation of the channel bottom with respect to some datum.

$$H = z + d + \alpha \frac{v^2}{2g}$$

Equation 6-7.

where:

d = depth of flow (ft. or m).

For some applications, it may be more practical to compute the total energy head as a sum of the water surface elevation (relative to mean sea level) and velocity head.

$$H = WS + \alpha \frac{v^2}{2g}$$

Equation 6-8.

where:

WS = water-surface elevation or stage (ft. or m) = $z + d$.

Specific Energy Equation. If the channel is not too steep (slope less than 10 percent) and the streamlines are nearly straight and parallel, the specific energy, E , becomes the sum of the depth of flow and velocity head.

$$E = d + \alpha \frac{v^2}{2g}$$

Equation 6-9.

Kinetic Energy Coefficient. Some of the numerous factors that cause variations in velocity from point to point in a cross section are channel roughness, non-uniformities in channel geometry, bends, and upstream obstructions.

The velocity head based on average velocity does not give a true measure of the kinetic energy of the flow because the velocity distribution in a river varies from a maximum in the main channel to essentially zero along the banks. Get a weighted average value of the kinetic energy by multiplying

average velocity head by the kinetic energy coefficient (α). The kinetic energy coefficient is taken to have a value of 1.0 for turbulent flow in prismatic channels (channels of constant cross section, roughness, and slope) but may be significantly different than 1.0 in natural channels. Compute the kinetic energy coefficient with Equation 6-10:

$$\alpha = \frac{\sum(Q_i v_i^2)}{Qv^2} = \frac{\sum[K_i(K_i / A_i)^2]}{K_t(K_t / A_t)^2}$$

Equation 6-10.

where:

v_i = average velocity in subsection (ft./s or m/s) (see [Continuity Equation](#) section)

Q_i = discharge in same subsection (cfs or m³/s) (see [Continuity Equation](#) section)

Q = total discharge in channel (cfs or m³/s)

v = average velocity in river at section or Q/A (ft./s or m/s)

K_i = conveyance in subsection (cfs or m³/s) (see [Conveyance](#) section)

A_i = flow area of same subsection (sq. ft. or m²)

K_t = total conveyance for cross-section (cfs or m³/s)

A_t = total flow area of cross-section (sq. ft. or m²).

In manual computations, it is possible to account for dead water or ineffective flows in parts of a cross section by assigning values of zero or negative numbers for the subsection conveyances. The kinetic energy coefficient will, therefore, be properly computed. In computer models, however, it is not easy to assign zero or negative values because of the implicit understanding that conveyance and discharge are similarly distributed across a cross section. This understanding is particularly important at bends, embankments, and expansions, and at cross sections downstream from natural and manmade constrictions. The subdivisions should isolate any places where ineffective or upstream flow is suspected. Then, by omitting the subsections or assigning very large roughness coefficients to them, a more realistic kinetic energy coefficient is computed.

In some cases, your calculations may show kinetic energy coefficients in excess of 20, with no satisfactory explanations for the enormous magnitude of the coefficient. If adjacent cross sections have comparable values or if the changes are not sudden between cross sections, such values can be accepted. If the change is sudden, however, make some attempt to attain uniformity, such as using more cross sections to achieve gradual change, or by re-subdividing the cross section.

Energy Balance Equation

The Energy Balance Equation, Equation 6-1, relates the total energy of an upstream section (2) along a channel with the total energy of a downstream section (1). The parameters in the Energy Equation are illustrated in Figure 6-1. Equation 6-1 now can be expanded into Equation 6-11:

$$z_2 + d_2 + \alpha_2 \frac{v_2^2}{2g} = z_1 + d_1 + \alpha_1 \frac{v_1^2}{2g} + h_f + \text{other losses}$$

Equation 6-11.

where:

- z = elevation of the streambed (ft. or m)
- d = depth of flow (ft. or m)
- α = kinetic energy coefficient
- v = average velocity of flow (fps or m/s)
- h_f = friction head loss from upstream to downstream (ft. or m)
- g = acceleration due to gravity = 32.2 ft/ s² or 9.81 m/s².

The energy grade line (EGL) is the line that joins the elevations of the energy head associated with a water surface profile (see Figure 6-1).

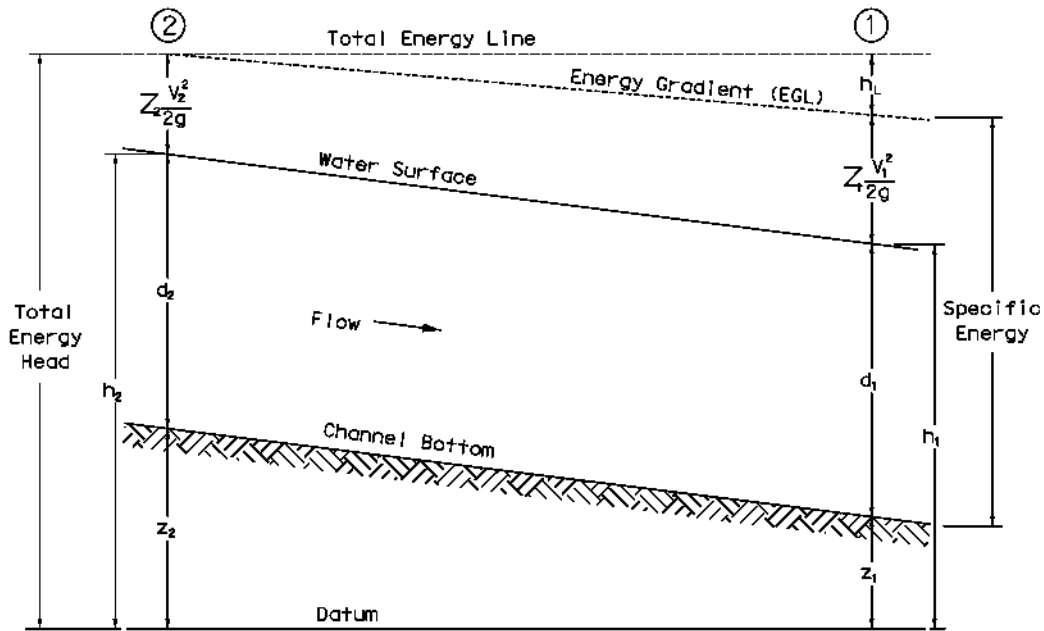

Figure 6-1. EGL for Water Surface Profile

Depth of Flow

Uniform depth (d_u) of flow (sometimes referred to as normal depth of flow) occurs when there is uniform flow in a channel or conduit. Uniform depth occurs when the discharge, slope, cross-sectional geometry, and roughness characteristics are constant through a reach of stream. See [Slope Conveyance Method](#) for how to determine uniform depth of flow in an open channel (Chapter 7).

By plotting specific energy against depth of flow for constant discharge, a specific energy diagram is obtained (see Figure 6-2). When specific energy is a minimum, the corresponding depth is critical depth (d_c). Critical depth of flow is a function of discharge and channel geometry. For a given discharge and simple cross-sectional shapes, only one critical depth exists. However, in a compound channel such as a natural floodplain, more than one critical depth may exist.

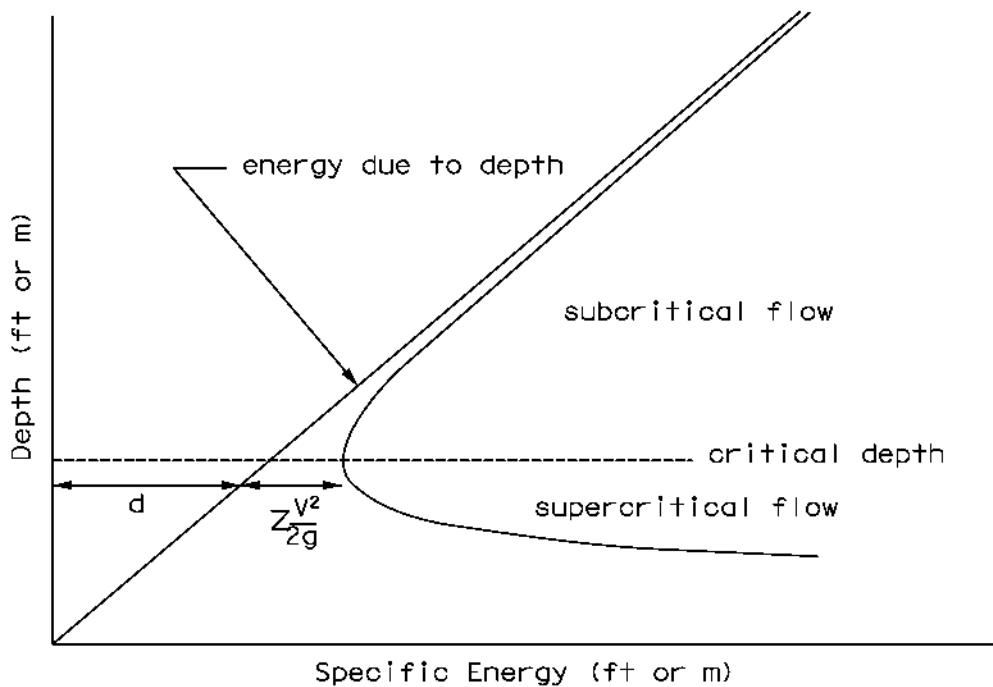

Figure 6-2. Typical Specific Energy Diagram

You can calculate critical depth in rectangular channels with the following Equation 6-12:

$$d_c = 3 \sqrt{\frac{q^2}{g}}$$

Equation 6-12.

where:

q = discharge per ft. (m) of width (cfs/ft. or $m^3/s/m$).

You can determine the critical depth for a given discharge and cross section iteratively with Equation 6-13:

$$\frac{Q^2}{g} = \frac{A_c^3}{T_c}$$

Equation 6-13.

where:

T_c = water surface width for critical flow (ft. or m)

A_c = area for critical flow (sq. ft. or m²).

Froude Number

The Froude Number (F_r) represents the ratio of inertial forces to gravitational forces and is calculated using Equation 6-14.

$$F_r = \frac{v}{\sqrt{g d_m}}$$

Equation 6-14.

where:

v = mean velocity (fps or m/s)

g = acceleration of gravity (32.2 ft/ s² or 9.81 m/s²)

d_m = hydraulic mean depth = A / T (ft. or m)

A = cross-sectional area of flow (sq. ft. or m²)

T = channel top width at the water surface (ft. or m).

The expression for the Froude Number applies to any single section of channel. The Froude Number at critical depth is always 1.0.

Flow Types

Several recognized types of flow are theoretically possible in open channels. The methods of analysis as well as certain necessary assumptions depend on the type of flow under study. Open channel flow is usually classified as uniform or non-uniform, steady or unsteady, or or critical or supercritical.

Non-uniform, unsteady, subcritical flow is the most common type of flow in open channels in Texas. Due to the complexity and difficulty involved in the analysis of non-uniform, unsteady flow, most hydraulic computations are made with certain simplifying assumptions which allow the application of steady, uniform, or gradually varied flow principles and one-dimensional methods of analysis.

Steady, Uniform Flow. Steady flow implies that the discharge at a point does not change with time, and uniform flow requires no change in the magnitude or direction of velocity with distance along a streamline such that the depth of flow does not change with distance along a channel. Steady, uniform flow is an idealized concept of open channel flow that seldom occurs in natural channels and is difficult to obtain even in model channels. However, for practical highway applications, the flow is steady, and changes in width, depth, or direction (resulting in non-uniform flow) are sufficiently small so that flow can be considered uniform. A further assumption of rigid, uniform boundary conditions is necessary to satisfy the conditions of constant flow depth along the channel. Alluvial, sand bed channels do not exhibit rigid boundary characteristics.

Steady, Non-uniform Flow. Changes in channel characteristics often occur over a long distance so that the flow is non-uniform and gradually varied. Consideration of such flow conditions is usually reasonable for calculation of water surface profiles in Texas streams, especially for the hydraulic design of bridges.

Subcritical/Supercritical Flow. Most Texas streams flow in what is regarded as a subcritical flow regime. Subcritical flow occurs when the actual flow depth is higher than critical depth. A Froude Number less than 1.0 indicates subcritical flow. This type of flow is tranquil and slow and implies flow control from the downstream direction. Therefore, the analysis calculations are carried out from downstream to upstream. In contrast, supercritical flow is often characterized as rapid or shooting, with flow depths less than critical depth. A Froude Number greater than 1.0 indicates supercritical flow. The location of control sections and the method of analysis depend on which type of flow prevails within the channel reach under study. A Froude number equal to, or close to, 1.0 indicates instability in the channel or model. A Froude number of 1.0 should be avoided if at all possible.

Cross Sections

A typical cross section represents the geometric and roughness characteristics of the stream reach in question. Figure 6-3 is an example of a plotted cross section.

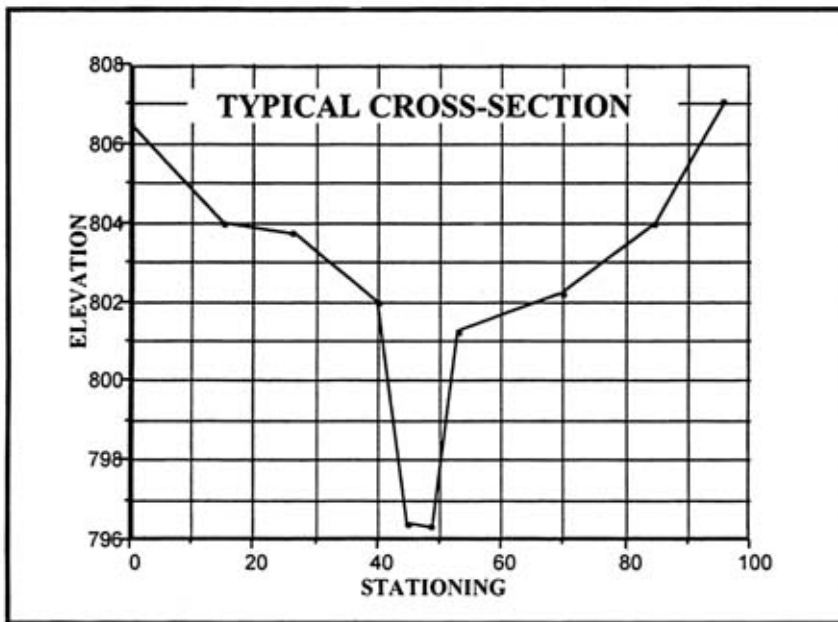

Figure 6-3. Plotted Cross Section

Most of the cross sections selected for determining the water surface elevation at a highway crossing should be downstream of the highway because most Texas streams exhibit subcritical flow. Calculate the water surface profile through the cross sections from downstream to upstream. Generate enough cross sections upstream to determine properly the extent of the backwater created by the highway crossing structure. See Chapter 4 for details on cross sections.

Roughness Coefficients

All water channels, from natural stream beds to lined artificial channels, exhibit some resistance to water flow, and that resistance is referred to as roughness. Hydraulic roughness is not necessarily synonymous with physical roughness. All hydraulic conveyance formulas quantify roughness subjectively with a coefficient. In Manning's Equation, the roughness coefficients, or *n*-values, for Texas streams and channels range from 0.200 to 0.012; values outside of this range are probably not realistic.

Determination of a proper *n*-value is the most difficult and critical of the engineering judgments required when using the Manning's Equation.

You can find suggested values for Manning's roughness coefficient ("*n*" values) in design charts such as the one shown in the file named [nvalues.doc](#) ([NVALUES](#)). Any convenient, published design guide can be referenced for these values. Usually, reference to more than one guide can be productive in that more opinions are collected. You can find a productive and systematic approach for this task in the FHWA publication [TS-84-204](#), *Guide for Selecting Manning's Roughness Coefficients for Natural Channels and Flood Plains*.

However inexact and subjective the n -value determination may be, the n -values in a cross section are definite and unchangeable for a particular discharge and flow depth. Therefore, once you have carefully chosen the n -values, do not adjust them just to provide another answer. If there is uncertainty about particular n -value choices, consult a more experienced designer.

In some instances, such as a trapezoidal section under a bridge, the n -value may vary drastically within a section, but you should not subdivide the section. If the n -value varies as such, use a weighted n -value (n_w). This procedure is defined by Equation 6-15 as follows:

$$n_w = \frac{\sum (n WP)}{\sum WP}$$

Equation 6-15.

where:

WP = subsection wetted perimeter

n = subsection n -value.

Subdividing Cross Sections

Because any estimating method involves the calculation of a series of hydraulic characteristics of the cross section, arbitrary water-surface elevations are applied to the cross section. The computation of flow or conveyance for each water-surface application requires a hydraulic radius, as seen in Figure 6-4. The hydraulic radius is intended as an average depth of a conveyance. A hydraulic radius and subsequent conveyance is calculated under each arbitrary water surface elevation. If there is significant irregularity in the depth across the section, the hydraulic radius may not accurately represent the flow conditions. Divide the cross section into sufficient subsections so that realistic hydraulic radii are derived.

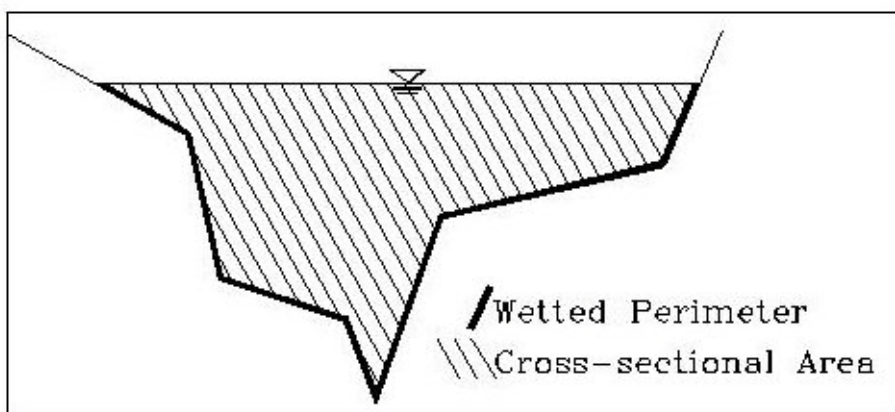

Figure 6-4. Cross Section Area and Wetted Perimeter

Subsections may be described with boundaries at changes in geometric characteristics and changes in roughness elements (see Figure 6-5). Note that the vertical length between adjacent subsections is not included in the wetted perimeter. The wetted perimeter is considered only along the solid boundaries of the cross sections, not along the water interfaces between subsections.

Adjacent subsections may have identical n -values. However, the calculation of the subsection hydraulic radius will show a more consistent pattern as the tabulation of hydraulic characteristics of the cross section is developed.

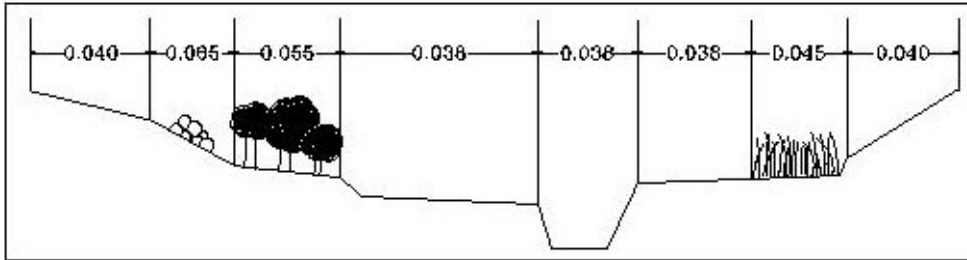

Figure 6-5. Subdividing With Respect to Geometry and Roughness

Subdivide cross sections primarily at major breaks in geometry. Additionally, major changes in roughness may call for additional subdivisions. You need not subdivide basic shapes that are approximately rectangular, trapezoidal, semicircular, or triangular.

Subdivisions for major breaks in geometry or for major changes in roughness should maintain these approximate basic shapes so that the distribution of flow or conveyance is nearly uniform in a subsection.

Importance of Correct Subdivision

The importance of proper subdivision as well as the effects of improper subdivision can be illustrated dramatically. Figure 6-6 shows a trapezoidal cross section having heavy brush and trees on the banks and subdivided near the bottom of each bank because of the abrupt change of roughness.

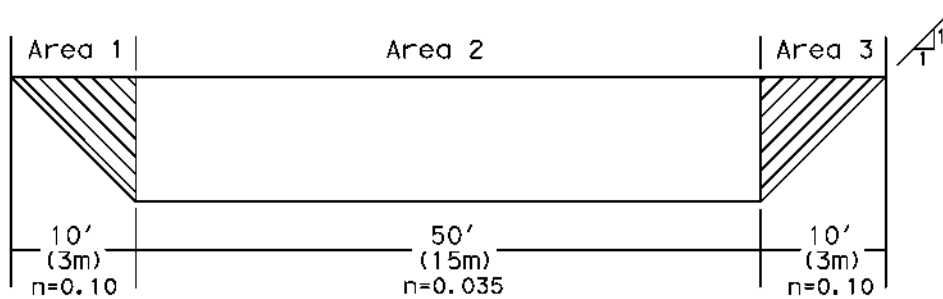

Figure 6-6. Subdivision of a Trapezoidal Cross Section

The conveyance for each subarea is calculated as follows:

$A_1 = A_3 = 50 \text{ ft}^2$	$A_1 = A_3 = 4.5 \text{ m}^2$
$P_1 = P_3 = 14.14 \text{ ft}$	$P_1 = P_3 = 4.24 \text{ m}$
$R_1 = R_3 = A_1/P_1 = 3.54 \text{ ft}$	$R_1 = R_3 = A_1/P_1 = 1.06 \text{ m}$
$K_1 = K_3 = 1.486A_1R_1^{2/3}/n = 1724.4 \text{ cfs}$	$K_1 = K_3 = A_1R_1^{2/3}/n = 46.8 \text{ m}^3/\text{s}$
$A_2 = 500 \text{ ft}^2$	$A_2 = 45 \text{ m}^2$
$P_2 = 50 \text{ ft}$	$P_2 = 15 \text{ m}$
$R_2 = A_2/P_2 = 10 \text{ ft}$	$R_2 = A_2/P_2 = 3 \text{ m}$
$K_2 = 1.486A_2R_2^{2/3}/n = 98534.3 \text{ cfs}$	$K_2 = A_2R_2^{2/3}/n = 2674.4 \text{ m}^3/\text{s}$

When the subareas are combined, the effective n-value for the total area can be calculated.

$A_c = A_1 + A_2 + A_3 = 600 \text{ ft}^2$	$A_c = A_1 + A_2 + A_3 = 54 \text{ m}^2$
$P_c = P_1 + P_2 + P_3 = 78.28 \text{ ft}$	$P_c = P_1 + P_2 + P_3 = 23.5 \text{ m}$
$R_c = A_c/P_c = 7.66 \text{ ft}$	$R_c = A_c/P_c = 2.3 \text{ m}$
$K_T = K_1 + K_2 + K_3 = 101983 \text{ cfs}$	$K_T = K_1 + K_2 + K_3 = 2768 \text{ m}^3/\text{s}$

$A_c = A_1 + A_2 + A_3 = 600 \text{ ft}^2$	$A_c = A_1 + A_2 + A_3 = 54 \text{ m}^2$
$n = 1.486A_cR_c^{2/3}/K_T = 0.034$	$n = A_cR_c^{2/3}/K_T = 0.034$

A smaller wetted perimeter in respect to area abnormally increases the hydraulic radius ($R = A / P$), and this results in a computed conveyance different from that determined for a section with a complete wetted perimeter. As shown above, a conveyance (K_T) for the total area would require a composite n -value of 0.034. This is less than the n -values of 0.035 and 0.10 that describe the roughness for the various parts of the basic trapezoidal shape. Do not subdivide the basic shape. Assign an effective value of n somewhat higher than 0.035 to this cross section, to account for the additional drag imposed by the larger roughness of the banks.

At the other extreme, you must subdivide the panhandle section in Figure 6-7, consisting of a main channel and an overflow plain, into two parts. The roughness coefficient is 0.040 throughout the total cross section. The conveyance for each subarea is calculated as follows:

$A_1 = 195 \text{ ft}^2$	$A_1 = 20 \text{ m}^2$
$P_1 = 68 \text{ ft}$	$P_1 = 21 \text{ m}$
$R_1 = A_1/P_1 = 2.87 \text{ ft}$	$R_1 = A_1/P_1 = 0.95 \text{ m}$
$K_1 = 1.486A_1R_1^{2/3}/n = 14622.1 \text{ cfs}$	$K_1 = A_1R_1^{2/3}/n = 484.0 \text{ m}^3/\text{s}$
$A_2 = 814.5 \text{ ft}^2$	$A_2 = 75.5 \text{ m}^2$
$P_2 = 82.5 \text{ ft}$	$P_2 = 24.9 \text{ m}$
$R_2 = A_2/P_2 = 9.87 \text{ ft}$	$R_2 = A_2/P_2 = 3.03 \text{ m}$
$K_2 = 1.486A_2R_2^{2/3}/n = 139226.2 \text{ cfs}$	$K_2 = A_2R_2^{2/3}/n = 3954.2 \text{ m}^3/\text{s}$

The effective n -value calculations for the combined subareas are as follows:

$A_c = A_1 + A_2 = 1009.5 \text{ ft}^2$	$A_c = A_1 + A_2 = 95.5 \text{ m}^2$
$P_c = P_1 + P_2 = 150.5 \text{ ft}$	$P_c = P_1 + P_2 = 45.9 \text{ m}$
$R_c = A_c/P_c = 6.71 \text{ ft}$	$R_c = A_c/P_c = 2.08 \text{ m}$
$K_T = K_1 + K_2 = 153848.3 \text{ cfs}$	$K_T = K_1 + K_2 = 4438.2 \text{ m}^3/\text{s}$
$n = 1.486A_cR_c^{2/3}/K_T = 0.035$	$n = A_cR_c^{2/3}/K_T = 0.035$

If you do not subdivide the section, the increase in wetted perimeter of the floodplain is relatively large with respect to the increase in area. The hydraulic radius is abnormally reduced, and the calculated conveyance of the entire section (K_c) is lower than the conveyance of the main channel, K_2 .

You should subdivide irregular cross sections such as that in Figure 6-7 to create individual basic shapes.

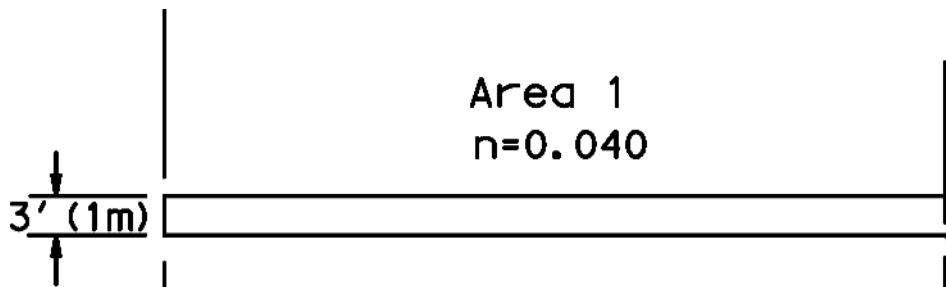

Figure 6-7. Subdividing a “Panhandle” Cross Section

The cross section shapes in Figure 6-6 through Figure 6-9 represent extremes of the problems associated with improper subdivision. A bench panhandle, or terrace, is a shape that falls between these two extremes (see Figure 6-8). Subdivide bench panhandles if the ratio L/d is equal to five or greater.

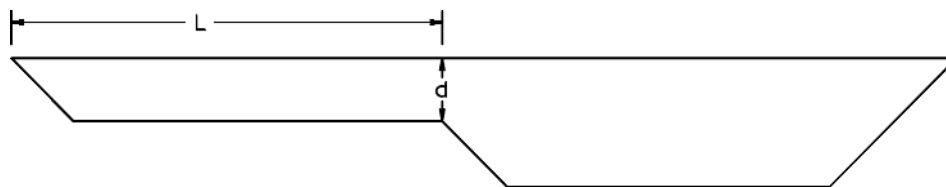

Figure 6-8. Bench Panhandle Cross Section

The following guidelines apply to the subdivision of triangular sections (see Figure 6-9):

- ◆ Subdivide if the central angle is 150 or more (L/d is five or greater).
- ◆ If L/d is almost equal to five, then subdivide at a distance of $L/4$ from the edge of the water.
- ◆ Subdivide in several places if L/d is equal to or greater than 20.
- ◆ No subdivisions are required on the basis of shape alone for small values of L/y , but subdivisions are permissible on the basis of roughness distribution.

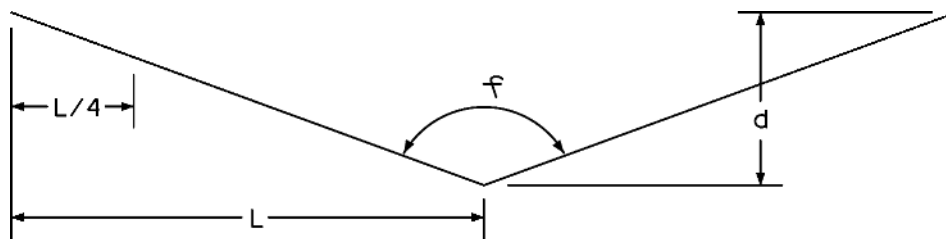

Figure 6-9. Triangular Cross Section

Figure 6-10 shows another shape that commonly causes problems in subdivision. In this case, subdivide the cross section if the main-channel depth (d_{\max}) is more than twice the depth at the stream edge of the overbank area (d_b).

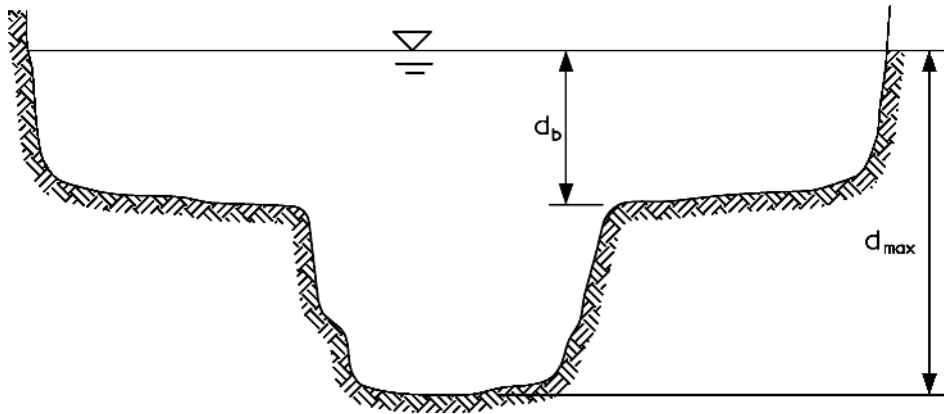

Figure 6-10. Problematic Cross Section

In some cases the decision to subdivide is difficult. Subdivisions in adjacent sections along the stream reach should be similar to avoid large differences in the kinetic energy coefficient (α). Therefore, if a borderline case is between sections not requiring subdivision, do not subdivide the borderline section. If it is between sections that must be subdivided, subdivide this section as well.

Section 2 — Flow in Conduits

Open Channel Flow or Pressure Flow

When a conduit is not submerged, the principles of [open channel flow](#) apply. When the conduit is submerged, pressure flow exists because the water surface is not open to the atmosphere, and the principles of conduit flow apply. For circular pipes flowing full, Equation 6-3 becomes:

$$Q = \frac{z}{n} D^{8/3} S^{1/2}$$

Equation 6-16.

where:

Q = discharge (cfs or m³/s)

z = 0.4644 for English measurement or 0.3116 for metric.

n = Manning's roughness coefficient

D = pipe diameter, ft. or m

S = slope of the energy gradeline (ft./ft. or m/m) (For uniform, steady flow, S = channel slope, ft./ft. or m/m).

Depth in Conduits

The equations for [critical depth](#) apply to conduits, too. Determine critical depth for a rectangular conduit using [Equation 6-12](#) and the discharge per barrel. Calculate critical depth for circular and pipe-arch or irregular shapes by trial and error use of [Equation 6-13](#). For a circular conduit, use Equation 6-17 and Equation 6-18 to determine the area, A, and top width, T, of flow, respectively. For other shapes, acquire or derive relationships from depth of flow, area, and top width.

$$A = \frac{D^2}{8} \left[2 \cos^{-1} \left(1 - \frac{2d}{D} \right) - \sin \left(2 \cos^{-1} \left(1 - \frac{2d}{D} \right) \right) \right]$$

Equation 6-17.

$$T = D \sin \left(\cos^{-1} \left(\frac{2d - D}{D} \right) \right)$$

Equation 6-18.

where:

A = section area of flow, sq. ft. or m^2

T = width of water surface, ft. or m

d = depth of flow, ft. or m

D = pipe diameter, ft. or m

the $\cos^{-1}(\theta)$ is the principal value in the range $0 \leq \theta \leq \pi$.

Use [Equation 6-3](#) to determine uniform depth. For most shapes, a direct solution of Equation 6-3 for depth is not possible. The [Slope Conveyance Procedure](#) discussed in Chapter 7 is applicable. For rectangular shapes, area, A , and wetted perimeter, WP are simple functions of flow depth. For circular pipe, compute area using Equation 6-17, and compute wetted perimeter using Equation 6-19. For other shapes, acquire or derive the relationship from depth of flow, area, and wetted perimeter.

Refer to the table below for recommended Manning's roughness coefficients for conduit.

$$WP = D \cos^{-1} \left(1 - \frac{2d}{D} \right)$$

Equation 6-19.

Roughness Coefficients

The following table provides roughness coefficients for conduits.

Recommended Culvert Conduit Roughness Coefficients

Type of Conduit	n-Value
Concrete Box	0.012
Concrete Pipe	0.012
Smooth-lined metal pipe	0.012
Smooth lined plastic pipe	0.012
Corrugated metal pipe	0.015-0.027
Structural plate pipe	0.027-0.036
Long span structural plate	0.031
Corrugated metal (paved interior)	0.012
Plastic	0.012-0.024

Energy

The energy equation, Equation 6-6, applies to conduit flow, too. Additionally, the following concepts apply to conduit flow.

- ◆ For pressure flow, the depth, d , represents the distance from the flowline to the hydraulic grade line.
- ◆ For pressure flow, the slope of the energy grade line and hydraulic grade line through the conduit are parallel and are represented by the friction slope.
- ◆ Compute friction losses, h_f , as the product of friction slope and length of conduit.
- ◆ Consider the kinetic energy coefficient (α) equal to unity.
- ◆ Other losses include entrance losses, exit losses, and junction losses.

Refer to [Chapter 8](#) for directions to accommodate such losses for culvert design and [Chapter 10](#) for storm drain design.

Compute the velocity head at any location in a conduit using Equation 6-20.

where:

$$h_v = \left[\frac{v^2}{2g} \right]$$

Equation 6-20.

where:

v = flow velocity in culvert (ft./s or m/s).

g = the gravitational acceleration = 32.2 ft/ s² or 9.81 m/s².

The friction slope represents the slope of the energy grade line and is based upon Manning's Equation, rearranged as follows:

$$s_f = \left(\frac{Qn}{zR^{2/3}A} \right)^2$$

Equation 6-21.

where:

S_f = friction slope (ft./ft. or m/m)

z = 1.486 for English measurements and 1.0 for metric.

Steep Slope versus Mild Slope

When critical depth (d_c) is higher than uniform depth (d_u), the slope is steep. The conduit may flow completely full (pressure flow) or partly full (free surface flow). The free surface flow may be supercritical or subcritical depending on tailwater conditions.

When critical depth is lower than uniform depth, the slope is termed mild. Pressure flow or free surface flow may occur. Free surface flow is most likely to be subcritical within the conduit.

The shape of the free water surface is dependent on whether the conduit slope is steep or mild and on the tailwater conditions. The [Standard Step Procedure](#) described in Chapter 7 accommodates the differences in water surface shape.

Section 3 — Hydraulic Grade Line Analysis

Introduction

Analyze the system's hydraulic grade line (sometimes referred to as the HGL) to determine if you can accommodate design flows in the drainage system without causing flooding at some location or causing flows to exit the system at locations where this is unacceptable.

Hydraulic Grade Line Considerations

Develop the hydraulic grade line for the system to determine probable water levels that may occur during a storm event. You can then evaluate these water levels with respect to critical elevations within the designed facility. The development of the hydraulic grade line is a last step in the overall design of a storm drain system.

The hydraulic grade line is the locus of elevations to which the water would rise if open to atmospheric pressure (e.g., piezometer tubes) along a pipe run (see [Figure 6-11](#)). The difference in elevation of the water surfaces in successive tubes separated by a specific length usually represents the friction loss for that length of pipe, and the slope of the line between water surfaces is the friction slope.

If you place a pipe run on a calculated friction slope corresponding to a certain rate of discharge, a cross section, and a roughness coefficient, the surface of flow (hydraulic grade line) is parallel to the top of the conduit.

If there is reason to place the pipe run on a slope less than friction slope, then the hydraulic gradient would be steeper than the slope of the pipe run (pressure flow).

Depending on the elevation of the hydraulic grade line at the downstream end of the subject run, it is possible to have the hydraulic grade line rise above the top of the conduit. That is, the conduit is under pressure until, at some point upstream, the hydraulic grade line is again at or below the level of the soffit of the conduit.

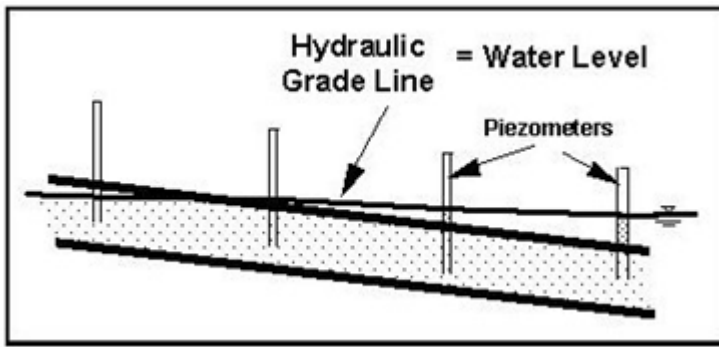

Figure 6-11. Hydraulic Grade Line

Analyze to determine the flow characteristics of the outfall channel. Use the tailwater level occurring in the outfall to the storm drain system in the development of a hydraulic grade line.

Use a realistic tailwater elevation as the basis for the hydraulic grade line calculation. If the outfall tailwater is a function of a relatively large watershed area (such as a large stream) and you base the contribution from the storm drain system on a relatively small total watershed area, then it is not realistic to use a tailwater elevation based on the same frequency as the storm drain design frequency. Refer to Section 3 of Chapter 5 for the [design frequency](#) in the hydraulic grade line development of a storm drain system.

Stage versus Discharge Relation

Generally a stage versus discharge relation for the outfall channel is useful. Refer to the [Slope Conveyance Procedure](#) in Chapter 7 for considerations and a procedure leading to the development of a stage versus discharge relation in an outfall channel.

As a normal design practice, calculate the hydraulic grade line when the tailwater surface elevation at the outlet is greater than the soffit elevation of the outlet pipe or boxes. If you design the system as a non-pressure system, ignoring junction losses, the hydraulic grade line eventually will fall below the soffit of the pipe somewhere in the system, at which point the hydraulic grade line calculation is no longer necessary. Generally, check the hydraulic grade line. However, such calculations are not needed if the system has all of the following characteristics:

- ◆ All conduits are designed for non-pressure flow.
- ◆ Potential junction losses are insignificant.
- ◆ Tailwater is below the soffit of the outfall conduit.

If the proposed system drains into another enclosed system, analyze the downstream system to determine the effect of the hydraulic grade line.

Conservation of Energy Calculation

When defining the hydraulic grade line, calculations proceed from the system outfall upstream to each of the terminal nodes. For department practice, base calculation of the hydraulic grade line on conservation of energy as shown in Equation 6-22 which includes major and minor energy losses within the system. For conduit, $d=1$.

$$HGL_{us} + \frac{v_{us}^2}{2g} = HGL_{ds} + \frac{v_{ds}^2}{2g} + h_f + h_m$$

Equation 6-22.

where:

$HGL_{us} = 2 + d$ = elevation of the hydraulic grade line at upstream node (ft. or m)

v_{us} = upstream velocity (fps or m/s)

v_{ds} = downstream velocity (ft./s or m/s)

h_m = minor (junction/node) head loss (ft. or m)

h_f = friction head loss (ft. or m)

HGL_{ds} = elevation of hydraulic grade line at downstream node (ft. or m)

$g = 32.2 \text{ ft./s}^2$ or 9.81 m/s^2 .

Minor Energy Loss Attributions

Major losses result from friction within the pipe. Minor losses include those attributed to junctions, exits, bends in pipes, manholes, expansion and contraction, and appurtenances such as valves and meters.

Minor losses in a storm drain system are usually insignificant. In a large system, however, their combined effect may be significant. Methods are available to estimate these minor losses if they appear to be cumulatively important. You may minimize the hydraulic loss potential of storm drain system features such as junctions, bends, manholes, and confluences to some extent by careful design. For example, you can replace severe bends by gradual curves in the pipe run where right-of-way is sufficient and increased costs are manageable. Well designed manholes and inlets, where there are no sharp or sudden transitions or impediments to the flow, cause virtually no significant losses.

Entrance Control

Generally treat a storm drain conduit system as if it operates in subcritical flow. As such, entrance losses of flow into each conduit segment are mostly negligible. However, if discharge enters into the system through a conduit segment in which there must be supercritical flow, significant head

losses are encountered as the discharge builds enough energy to enter the conduit. This situation is most likely where a lateral is located on a relatively steep slope. On such slopes, evaluate the type of flow (subcritical or supercritical).

With supercritical flow, the lateral may be operating under entrance control. When a lateral is operating under entrance control as described above, the headwater level is usually much higher than a projection of the hydraulic grade line.

If the entrance control headwater submerges the free fall necessary for the inlet to function properly, it may be necessary to reconfigure the lateral by increasing its size or changing its slope. Some improvement to the inlet characteristics may help to overcome any unfavorable effects of entrance control. Usually, entrance control does not affect steep units in the trunk lines because the water is already in the conduit; however, you may need to consider velocity head losses.

Use the following procedure to determine the entrance control head:

1. Calculate critical depth as discussed in [Critical Depth in Conduit](#) earlier in this section.
2. If critical depth exceeds uniform depth, go to step 3; otherwise, no entrance control check is necessary.
3. Calculate entrance head in accordance with the [Headwater Under Inlet Control](#) subsection in Chapter 8.
4. Add entrance head to flowline and compare with the hydraulic grade line at the node.
5. Take the highest of the two values from step 4. Check to ensure that this value is below the throat of the inlet.

Hydraulic Grade Line Procedure

Use the following procedure to determine the entrance control head:

1. Determine an appropriate water level in the outfall channel or facility. For an open channel outfall, the appropriate water level will be a function of the stage vs. discharge relation of flow in the outfall facility and designer's selection of design frequency for the storm drain facility. If the outfall tailwater level is lower than critical depth at the exiting conduit of the system, use the elevation associated with critical depth at that point as a beginning water surface elevation for the Hydraulic Grade Line calculation.
2. Compute the friction loss for each segment of the conduit system, beginning with the most downstream run. The friction loss (h_f) for a segment of conduit is defined by the product of the friction slope at full flow and the length of the conduit as shown in Equation 6-23.

$$h_f = S_f L$$

Equation 6-23.

The friction slope, S_f , is calculated by rearranging Manning's Equation to Equation 6-24.

$$S_f = \frac{Q^2 n^2}{z^2 A^2 R^{4/3}}$$

Equation 6-24.

where:

S_f = friction slope (ft./ft. or m/m)

Q = discharge (cfs or m^3/s)

n = Manning's roughness coefficient

$z = 1.486$ for use with English measurements only.

A = cross-sectional area of flow (sq. ft. or m^2)

R = hydraulic radius (ft. or m) = A / WP

WP = wetted perimeter of flow (the length of the channel boundary in direct contact with the water) (ft. or m).

Combining Equation 6-23 with Equation 6-24 yields Equation 6-25 for friction loss.

$$h_f = \frac{Q^2 n^2}{z^2 A^2 R^{4/3}} L$$

Equation 6-25.

where:

$z = 1.486$ for use with English measurements units only.

L = length of pipe (ft. or m).

For a circular pipe flowing full, Equation 6-25 becomes Equation 6-26.

$$h_f = \left(\frac{Qn}{zD^{8/3}} \right)^2 L$$

Equation 6-26.

where:

$z = 0.4644$ for English measurement or 0.3116 for metric.

D = Pipe diameter (ft. or m).

For partial flow, you could use Equation 6-25 to approximate the friction slope. However, the backwater methods, such as the [\(Standard\) Step Backwater Method](#) outlined in Chapter 7, provide better estimates of the hydraulic grade line.

1. Using the downstream Hydraulic Grade Line elevation as a base, add the computed friction loss h_f . This will be the tentative elevation of the Hydraulic Grade Line at the upstream end of the conduit segment.
2. Compare the tentative elevation of the Hydraulic Grade Line as computed above to the elevation represented by uniform depth of flow added to the upstream flow line elevation of the subject conduit.
3. The higher of the two elevations from step 2 above will be the controlling Hydraulic Grade Line elevation (HGL_{us}) at the upstream node of the conduit run. (If you perform backwater calculations, the computed elevation at the upstream end becomes the Hydraulic Grade Line at that point).
4. If other losses are significant, calculate them using the procedures outlined below. Use Equation 6-27 to determine the effect of the sum of minor losses (h_m) on the Hydraulic Grade Line.

$$HGL_i = HGL_o + \frac{v_o^2}{2g} + h_m - \frac{v_i^2}{2g}$$

Equation 6-27.

5. If the upstream conduit is on a mild slope (i.e., critical depth is lower than uniform depth), set the starting Hydraulic Grade Line for the next conduit run (HGL_{ds}) to be the higher of critical depth and the Hydraulic Grade Line from step 3 (or 4 if minor losses were considered).
6. Go back to step 2 and continue the computations in an upstream direction into all branches of the conduit system. The objective is to compare the level of the Hydraulic Grade Line to all critical elevations in the storm drain system.
7. Check all laterals for possible entrance control head as described in the subsection below.
8. If the Hydraulic Grade Line level exceeds a critical elevation, you must adjust the system so that a revised Hydraulic Grade Line level does not submerge the critical elevation (this condition is sometimes referred to as a “blowout.”) Most adjustments are made with the objective of increasing capacity of those conduit segments causing the most significant friction losses. If the developed Hydraulic Grade Line does not rise above the top of any manhole or above the gutter invert of any inlet, the conduit system is satisfactory.

NOTE: If the conduit system does not include any pressure flow segments but the outlet channel elevation is higher than the top of the conduit at the system exit, compute the Hydraulic Grade Line through the system until the Hydraulic Grade Line level is no higher than the soffit of the conduit. At this point, continuance of the Hydraulic Grade Line is unnecessary, unless other losses are likely to be significant.

Chapter 7 — Channels

Contents:

[Section 1 — Introduction](#)

[Section 2 — Stream Channel Planning Considerations and Design Criteria](#)

[Section 3 — Roadside Channel Design](#)

[Section 4 — Stream Stability Issues](#)

[Section 5 — Channel Analysis Guidelines](#)

[Section 6 — Channel Analysis Methods](#)

Section 1 — Introduction

Open Channel Types

In this chapter, the term open channel includes the total conveyance facility (the floodplain and stream channel). This chapter addresses required design criteria, design philosophy, and channel design and analysis procedures.

The various types of open channels include stream channels, roadside channels or ditches, and artificial channels such as irrigation channels or drainage ditches. The hydraulic design process for open channels consists of establishing criteria, developing and evaluating alternatives, and selecting the alternative that best satisfies the criteria. Plan for capital investment and probable future costs, including maintenance and flood damage to property, traffic service requirements, and stream and floodplain environment. Evaluate risks warranted by flood hazard at the site, economics, and current engineering practices.

Use channel design to determine the channel cross section required to accommodate a given discharge. This includes sizing outfall channels and various roadway ditches. Channel design involves selection of trial channel characteristics, application of channel analysis methods, and then iteration until the trial characteristics meet the desired criteria.

Analyze the channel to determine the depth and average velocity at which the discharge flows in a channel with an established cross section. Use channel analysis most frequently to establish a water surface elevation that influences the design or analysis of a hydraulic structure or an adjacent roadway profile scheme.

Assess the following when designing transportation drainage systems:

- ◆ potential flooding caused by changes in water surface profiles
- ◆ disturbance of the river system upstream or downstream of the highway right-of-way
- ◆ changes in lateral flow distributions
- ◆ changes in velocity or direction of flow
- ◆ need for conveyance and disposal of excess runoff
- ◆ need for [channel linings](#) to prevent erosion.

Methods Used for Depth of Flow Calculations

Use the [Slope Conveyance Method](#) and [Standard Step Backwater Method](#), described in this chapter, for calculating depth of flow for analyzing an existing channel or for designing a new or improved channel.

Section 2 — Stream Channel Planning Considerations and Design Criteria

Location Alternative Considerations

The planning phase for a highway section usually involves consideration of a number of alternate highway locations, which often require construction across or along streams and floodplains. During the planning phase, evaluate the effects that location alternatives would have on stream systems. (See the [Project Development Process Manual](#) for more details.) Include a preliminary hydraulic study of the various alternatives because the type and cost of drainage facilities required can determine location selection. As project development proceeds, you may find that locations selected without adequate hydraulic consideration to floodplain encroachments and extensive channel modifications are unacceptable.

Consider the environmental effects, risks, and costs of required drainage facilities in the final selection of an alternative. Analysis of alternative alignments may reveal possibilities for reducing construction costs, flood damage potential, maintenance problems, and adverse environmental impacts.

Detailed information and survey data are seldom available for an in-depth hydraulic study during the planning phase; however, it is possible to ascertain basic requirements and consequences of a particular location or alignment and the relative merits of alternatives. Topographic maps, aerial photography, stream gage data, floodplain delineation maps, and a general knowledge of the area often provide the basis for preliminary evaluations of alternatives.

Phase Planning Assessments

Consider the following factors:

- ◆ water quality standards
- ◆ stream stability
- ◆ heavy debris discharge
- ◆ highly erodible banks
- ◆ fish and wildlife resources.

Assessments may require the cooperative efforts of Area Office designers and Division personnel as well as others with experience on similar projects or specialized expertise in the particular area. Design all projects to comply with Federal and State regulations. As such, it is necessary to consider the implications of the following:

- ◆ [Federal Emergency Management Agency National Flood Insurance Program](#) (FEMA NFIP)
- ◆ U.S. Corps of Engineers (USACE) [404 permit](#)

- ◆ [U.S. Fish and Wildlife](#) requirements
- ◆ Environmental Protection Agency (EPA) National Pollutant Discharge Elimination System (NPDES) [Municipal Separate Storm Sewer System permit requirements](#)
- ◆ [EPA NPDES](#) permit for industrial activity (construction)
- ◆ [EPA Endangered Species Act](#) provisions

Refer to the [Project Development Process Manual](#) for more information on the above regulations.

Environmental Assessments

Consult the Chapter 3, [Environmental](#) in *Project Development Process Manual* for environmental concerns. (See Texas Parks and Wildlife Department (TPWD), Clean Water Act (CWA), in the Environmental Procedures in Project Development Process Manual.) Consider stream channel modification only after examining all other alternatives. Regulatory requirements invoked by stream channel modifications can be substantial.

Consider the [U.S. Fish and Wildlife Service](#) (USFWS) review requirements where review may result in recommendations to avoid, minimize, or compensate for the adverse effects to wildlife habitat.

Refer to Chapter 3, [Environmental](#) for more information. It is prudent to plan measures to avoid, minimize, or compensate for stream modifications.

Justify the selection of a stream modification alternative. Consult with resource agencies early in design planning, and include these consultations in the Environmental Assessment Statement (EAS) or Environmental Impact Statement (EIS) with supporting documentation. (See Chapter 3, [Environmental](#), in the *Project Development Process Manual* for more details.) The EA should also contain compensation plans for replacing any removed habitats. Avoid or minimize adverse effects, or implement mitigation plans to the best of your ability when transportation projects impact riparian corridors as described in the Fish and Wildlife Coordination Act (FWCA). (See Chapter 3, [Environmental](#), in the *Project Development Process Manual* for more details.) If the department cannot offer mitigation for riparian corridor impacts, offer an explanation as justification in the environmental documentation.

Consultations with Respective Agencies

During the planning phase, contact Federal, State, and local agencies in regard to plans or land uses such as the following that could affect the highway drainage design:

- ◆ dams and reservoirs
- ◆ irrigation

- ◆ flood control levees or channel modifications
- ◆ navigation
- ◆ floodplain management
- ◆ zoning
- ◆ recreational use
- ◆ fish or wildlife management.

Consult the four agencies having regulatory authority over navigation and construction activities in waters of the United States and agencies with special expertise, such as in the limits and classification of wetlands, for preliminary information that may affect location decisions. The four agencies are as follows:

- ◆ [U.S. Coast Guard](#) (USCG), U.S. Department of Transportation
- ◆ [U.S. Army Corps of Engineers](#) (USACE), Department of Army
- ◆ [Federal Highway Administration](#) (FHWA)
- ◆ [Environmental Protection Agency](#) (EPA).

See [References](#) for contact information.

Other Agency Requirements

An increasing number of federal and state permits are required for construction activities that may involve navigation and water quality. Program application for permits and approvals by Federal and State agencies having regulatory authority over streams early in the project development process. See Chapter 2, Section 2, Federal Laws, Regulations, and Agencies Governing Hydraulic Design.

Stream Channel Criteria

Stream channel criteria include the following:

- ◆ Evaluate the hydraulic effects of floodplain encroachments for the peak discharges of the design AEP and the 1% AEP on any major highway facility.
- ◆ Avoid relocation or realignment of a stream channel wherever practicable.
- ◆ Match the cross-sectional shape, plan-view, roughness, sediment transport, and slope to the original conditions insofar as practicable.
- ◆ Include some means of energy dissipation when velocities through the structure are excessive or when the original conditions cannot be duplicated.

- ◆ Provide stream bank stabilization, when appropriate, to counteract any stream disturbance such as encroachment. Stabilize both upstream and downstream banks, as well as the local site. Refer to “Stream Stability at Highway Bridges,” [FHWA-IP-90-014](#) for guidance.
- ◆ Provide a sufficient top width with access for maintenance equipment for features such as dikes and levees associated with natural channel modifications. Provide turnaround points throughout and at the end of these features.

Section 3 — Roadside Channel Design

Roadside Drainage Channels

According to the AASHTO Roadside Design Guide, roadside drainage channel is an open channel usually paralleling the highway embankment and within limits of the ROW. The primary function of a drainage channel is to collect surface runoff from the roadway and areas that drain to the ROW and to convey the accumulated runoff to acceptable outlet points. Drainage channels must be designed to carry the design runoff and to accommodate excessive storm water with minimal roadway flooding or damage. For details of roadway safety design which governs ditch shape design, see the Roadway Design Manual, Chapter 2, Section 6, [Slopes and Ditches](#), and [Median Design](#), and Chapter 2, Section 7, [Side Ditches](#). Where the Roadway Design Manual requirements can't be met, the channel will have to be enclosed in a pipe or box. See Chapter 10, [Storm Drains](#).

Channel Linings

Channel lining may be desirable or necessary to minimize maintenance, resist the erosive forces of flowing water, improve hydraulic efficiency, and/or limit the channel size for right-of-way or safety considerations. The considerations of flow volumes, topography, and soil conditions may dictate the channel lining material to be used. Wherever possible, highway drainage channel design should make use of native, natural materials such as grass, crushed rock, and earth. Other types of materials for reasons of hydraulics, economics, safety, aesthetics, and environment may be considered.

The following section contains a short discussion on channel linings. For comprehensive descriptions, advantages, and disadvantages of different types of channel linings, refer to the FHWA Hydraulic Engineering Circular No. 15 ([HEC-15](#)).

Rigid versus Flexible Lining

Engineers may design roadside channels with rigid or flexible linings. Flexible linings in channels conform better to a changing channel shape than rigid linings. However, a rigid lining may resist an erosive force of high magnitude better than a flexible one.

The following types of rigid linings are common:

- ◆ cast-in-place concrete
- ◆ soil cement
- ◆ fabric form work systems for concrete
- ◆ grouted riprap.

Rigid channel linings have the following disadvantages when compared to natural or earth-lined channels:

- ◆ Initial construction cost of rigid linings is usually greater than the cost of flexible linings.
- ◆ Maintenance costs may also be high because rigid linings are susceptible to damage by undercutting, hydrostatic uplift, and erosion along the longitudinal interface between the lining and the unlined section.
- ◆ Inhibition of natural infiltration in locations where infiltration is desirable or permissible.
- ◆ Smooth linings usually cause high flow velocities with scour occurring at the terminus of the sections unless controlled with riprap or other energy dissipating devices
- ◆ Contaminants may be transported to the receiving waters in areas where water quality considerations are of major concern. A vegetative or flexible type of lining may filter the contaminants from the runoff.

Permanent flexible linings include the following:

- ◆ rock riprap
- ◆ wire enclosed riprap (gabions)
- ◆ vegetative lining
- ◆ geotextile fabrics.

Flexible linings generally have the following advantages:

- ◆ less costly to construct
- ◆ have self-healing qualities that reduce maintenance costs
- ◆ permit infiltration and exfiltration
- ◆ present a more natural appearance and safer roadsides.

Various species of grass may be used as permanent channel lining if flow depths, velocities, and soil types are within acceptable tolerances for vegetative lining. The turf may be established by sodding or seeding. Sod is usually more expensive than seeding, but it has the advantage of providing immediate protection. Some type of temporary protective covering is often required for seed and topsoil until vegetation becomes established.

The following are classified as temporary flexible linings:

- ◆ geotextile fabrics
- ◆ straw with net
- ◆ curled wood mat
- ◆ jute, paper, or synthetic net

- ◆ synthetic mat
- ◆ fiberglass roving.

Temporary channel lining and protective covering may consist of jute matting, excelsior mats, or fiberglass roving. Straw or wood-chip mulch tacked with asphalt is usually not well suited for channel invert lining but may be used for side slopes. Geotextile materials, known as soil stabilization mats, may be used for protective linings in ditches and on side slopes. These materials are not biodegradable and serve as permanent soil reinforcement while enhancing the establishment of vegetation.

Channel Lining Design Procedure

Use the following design procedure for roadside channels. Even though each project is unique, these six basic design steps normally apply:

1. Establish a roadside plan. Collect available site data:
 - Obtain or prepare existing and proposed plan/profile layouts including highway, culverts, bridges, etc.
 - Determine and plot on the plan the locations of natural basin divides and roadside channel outlets.
 - Lay out the proposed roadside channels to minimize diversion flow lengths.
2. Establish cross section geometry: Identify features that may restrict cross section design including right-of-way limits, trees or environmentally sensitive areas, utilities, and existing drainage facilities. Provide channel depth adequate to drain the subbase and minimize freeze-thaw effects. Choose channel side slopes based on the following geometric design criteria: safety, economics, soil, aesthetics, and access. Establish the bottom width of trapezoidal channel.
3. Determine initial channel grades. Plot initial grades on plan-profile layout (slopes in roadside ditch in cuts are usually controlled by highway grades) by establishing a minimum grade to minimize ponding and sediment accumulation, considering the influence of type of lining on grade, and where possible, avoiding features that may influence or restrict grade, such as utility locations.
4. Check flow capacities, and adjust as necessary. Compute the design discharge at the downstream end of a channel segment (see Chapter 5). Set preliminary values of channel size, roughness, and slope. Determine the maximum allowable depth of channel including free-board. Check the flow capacity using Manning's Equation for Uniform Flow and single-section analysis (see [Equation 7-1](#) and Chapter 6). If the capacity is inadequate, possible adjustments are as follows:
 - increase bottom width
 - make channel side slopes flatter

- make channel slope steeper
- provide smoother channel lining
- install drop inlets and a parallel storm drain pipe beneath the channel to supplement channel capacity
- provide smooth transitions at changes in channel cross sections
- provide extra channel storage where needed to replace floodplain storage or to reduce peak discharge

$$Q = \frac{Z}{n} AR^{2/3} S^{1/2}$$

Equation 7-1.

where:

Q = discharge (cfs or m³/s)

A = cross-sectional area of flow (sq. ft. or m²)

R = hydraulic radius (ft. or m)

Z = conversion factor; 1.486 for English units, and 1.0 for metric

5. Determine channel lining or protection needed. Calculate uniform flow depth (y_m in ft. or m) at design discharge using the [Slope Conveyance Method](#). Compute maximum shear stress at normal depth (see Equation 7-2 and Equation 7-3). Select a lining and determine the permissible shear stress (in lbs./sq.ft. or N/m²) using the tables titled [Retardation Class](#) for Lining Materials and [Permissible Shear Stresses](#) for Various Linings. If $\tau_d < \tau_p$, then the lining is acceptable. Otherwise, consider the following options: choose a more resistant lining, use concrete or gabions or other more rigid lining as full lining or composite, decrease channel slope, decrease slope in combination with drop structures, or increase channel width or flatten side slopes.
6. Analyze outlet points and downstream effects. Identify any adverse impacts to downstream properties that may result from one of the following at the channel outlet: increase or decrease in discharge, increase in velocity of flow, confinement of sheet flow, change in outlet water quality, or diversion of flow from another watershed. Mitigate any adverse impacts identified in the previous step. Possibilities include enlarging the outlet channel or installing control structures to provide detention of increased runoff in channel, installing velocity control structures, increasing capacity or improving the lining of the downstream channel, installing sedimentation/infiltration basins, installing sophisticated weirs or other outlet devices to redistribute concentrated channel flow, and eliminating diversions that result in downstream damage and that cannot be mitigated in a less expensive fashion.

$$\tau_d = 62.4RS$$

Equation 7-2. (English)

where:

τ_d = maximum shear stress at normal depth (lb./sq.ft.)

R = hydraulic radius (ft.) at ym

S = channel slope (ft./ft.)

$$\tau_d = 9810 RS$$

Equation 7-3. (Metric)

where:

t_d = maximum shear stress at normal depth (N/m²)

R = hydraulic radius (m)

S = channel slope (m/m)

Retardation Class for Lining Materials

Retardance Class	Cover	Condition
A	Weeping Lovegrass	Excellent stand, tall (average 30 in. or 760 mm)
	Yellow Bluestem Ischaemum	Excellent stand, tall (average 36 in. or 915 mm)
B	Kudzu	Very dense growth, uncut
	Bermuda grass	Good stand, tall (average 12 in. or 305 mm)
	Native grass mixture little bluestem, bluestem, blue gamma, other short and long stem medwest grasses	Good stand, unmowed
	Weeping lovegrass	Good Stand, tall (average 24 in. or 610 mm)
	Lespedeza sericea	Good stand, not woody, tall (average 19 in. or 480 mm)
	Alfalfa	Good stand, uncut (average 11 in or 280 mm)
	Weeping lovegrass	Good stand, unmowed (average 13 in. or 330 mm)
C	Kudzu	Dense growth, uncut
	Blue gamma	Good stand, uncut (average 13 in. or 330 mm)
	Crabgrass	Fair stand, uncut (10-to-48 in. or 55-to-1220 mm)
	Bermuda grass	Good stand, mowed (average 6 in. or 150 mm)
	Common lespedeza	Good stand, uncut (average 11 in. or 280 mm)
	Grass-legume mixture: summer (orchard grass redbtop, Italian ryegrass, and common lespedeza)	Good stand, uncut (6-8 in. or 150-200 mm)

Retardation Class for Lining Materials

Retardance Class	Cover	Condition
	Centipedegrass	Very dense cover (average 6 in. or 150 mm)
	Kentucky bluegrass	Good stand, headed (6-12 in. or 150-305 mm)
D	Bermuda grass	Good stand, cut to 2.5 in. or 65 mm
	Common lespedeza	Excellent stand, uncut (average 4.5 in. or 115 mm)
	Buffalo grass	Good stand, uncut (3-6 in. or 75-150 mm)
	Grass-legume mixture: fall, spring (orchard grass Italian ryegrass, and common lespedeza	Good Stand, uncut (4-5 in. or 100-125 mm)
	Lespedeza sericea	After cutting to 2 in. or 50 mm (very good before cutting)
E	Bermuda grass	Good stand, cut to 1.5 in. or 40 mm
	Bermuda grass	Burned stubble

Permissible Shear Stresses for Various Linings

Protective Cover	(lb./sq.ft.)	t_p (N/m²)
Retardance Class A Vegetation (See the “Retardation Class for Lining Materials” table above)	3.70	177
Retardance Class B Vegetation (See the “Retardation Class for Lining Materials” table above)	2.10	101
Retardance Class C Vegetation (See the “Retardation Class for Lining Materials” table above)	1.00	48
Retardance Class D Vegetation (See the “Retardation Class for Lining Materials” table above)	0.60	29
Retardance Class E Vegetation (See the “Retardation Class for Lining Materials” table above)	0.35	17
Woven Paper	0.15	7
Jute Net	0.45	22
Single Fiberglass	0.60	29
Double Fiberglass	0.85	41
Straw W/Net	1.45	69
Curled Wood Mat	1.55	74
Synthetic Mat	2.00	96
Gravel, $D_{50} = 1$ in. or 25 mm	0.40	19
Gravel, $D_{50} = 2$ in. or 50 mm	0.80	38
Rock, $D_{50} = 6$ in. or 150 mm	2.50	120
Rock, $D_{50} = 12$ in. or 300 mm	5.00	239

Permissible Shear Stresses for Various Linings

Protective Cover	(lb./sq.ft.)	t_p (N/m ²)
6-in. or 50-mm Gabions	35.00	1675
4-in. or 100-mm Geoweb	10.00	479
Soil Cement (8% cement)	>45	>2154
Dycel w/out Grass	>7	>335
Petraflex w/out Grass	>32	>1532
Armorflex w/out Grass	12-20	574-957
Erikamat w/3-in or 75-mm Asphalt	13-16	622-766
Erikamat w/1-in. or 25 mm Asphalt	<5	<239
Armorflex Class 30 with longitudinal and lateral cables, no grass	>34	>1628
Dycel 100, longitudinal cables, cells filled with mortar	<12	<574
Concrete construction blocks, granular filter underlayer	>20	>957
Wedge-shaped blocks with drainage slot	>25	>1197

Trial Runs

To optimize the roadside channel system design, make several trial runs before a final design is achieved. Refer to [HEC-15](#) for more information on channel design techniques and considerations.

Section 4 — Stream Stability Issues

Stream Geomorphology

Planning and location engineers should be conscious of fluvial geomorphology and request the services of hydraulics engineers to quantify natural changes and changes that may occur as a result of stream encroachments, crossings, or channel modifications.

Fluvial geomorphology and river mechanics are not new subjects; however, methods of quantifying the interrelation of variables are relatively recent developments. The theories and knowledge available today make it possible to estimate and predict various reactions to changes and, more importantly, to establish thresholds for tolerance to change.

Streams have inherent dynamic qualities by which changes continually occur in the stream position and shape. Changes may be slow or rapid, but all streams are subjected to forces that cause changes to occur. In these streams, banks erode, sediments are deposited, and islands and side channels form and disappear in time. The banks and adjacent floodplains usually contain a large proportion of sand, even though the surface strata may consist of silt and clay; thus, the banks erode and cave with relative ease.

Most alluvial channels exhibit a natural instability that results in continuous shifting of the stream through erosion and deposition at bends, formation and destruction of islands, development of oxbow lakes, and formation of braided channel sections.

The degree of channel instability varies with hydrologic events, bank and bed instability, type and extent of vegetation on the banks, and floodplain use.

The identification of these characteristics and understanding of the relationship of the actions and reactions of forces tending to effect change enables the design engineer to estimate the rates of change and evaluate potential upstream and downstream effects of natural change and proposed local channel modifications.

The potential response of the stream to natural and proposed changes may be quantified with the basic principles of river mechanics. The design engineer must understand and use these principles to minimize the potential effect of these dynamic systems on highways and the adverse effects of highways on stream systems.

Non-alluvial channels have highly developed meanders in solid rock valleys and may be degrading their beds. An example of such a stream is the Guadalupe River as it passes through the Edwards Aquifer recharge zone. Many mountain streams are classified as non-alluvial, and in these cases the design engineer may perform a hydraulic analysis utilizing rigid boundary theory.

Stream Classification

Figure 7-1 illustrates the three main natural channel patterns: straight, meandering, braided, and their relationships to each other. For a more complete explanation of this classification system, see FHWA/RD-80/160 “Methods for Assessment of Stream Related Hazards to Highways and Bridges”, Shen, et. al, 1981.

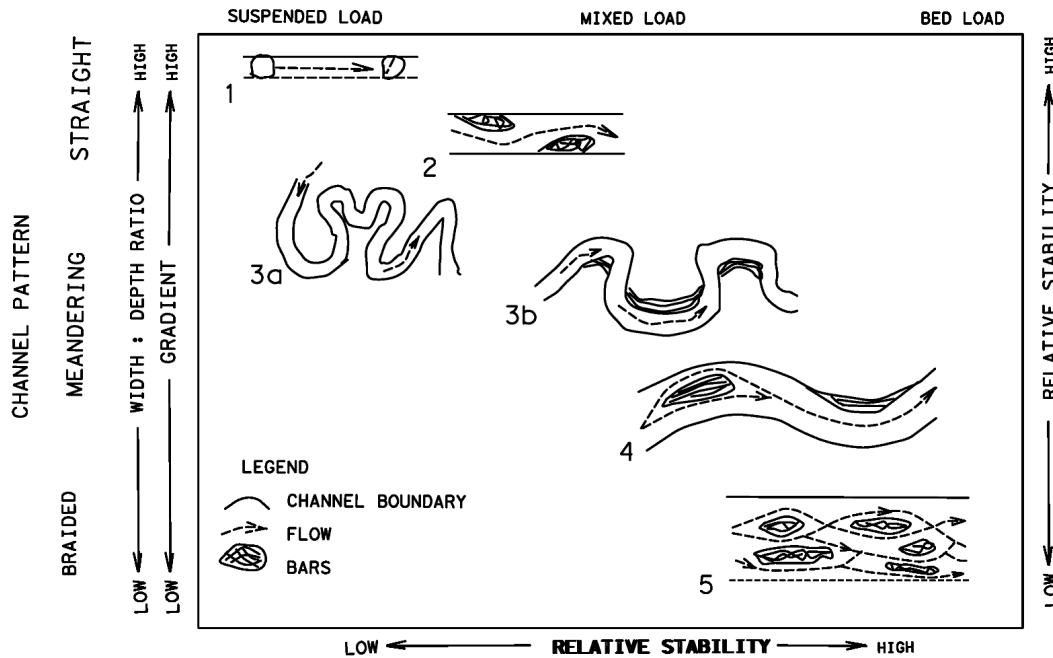

Figure 7-1. Natural Stream Patterns

Straight Streams. A stream is classified as straight when the ratio of the length of the thalweg (path of deepest flow; see Figure 7-2) to the length of the valley is less than 1.05. This ratio is known as the sinuosity of the stream. Degrees of sinuosity are illustrated in Figure 7-3.

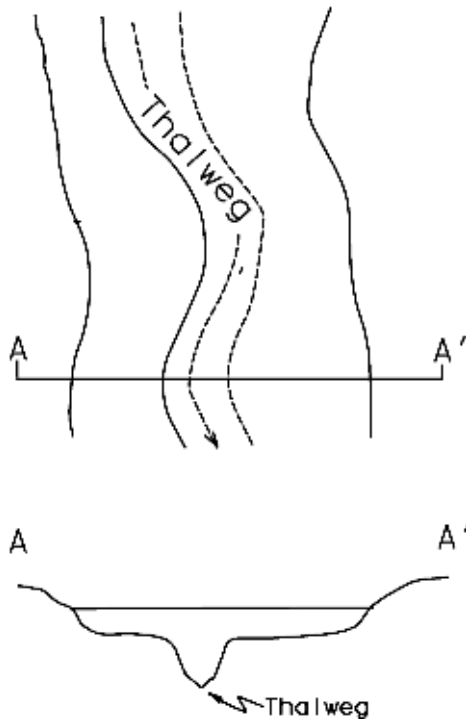

Figure 7-2. Thalweg Location in Plan View and Cross Section

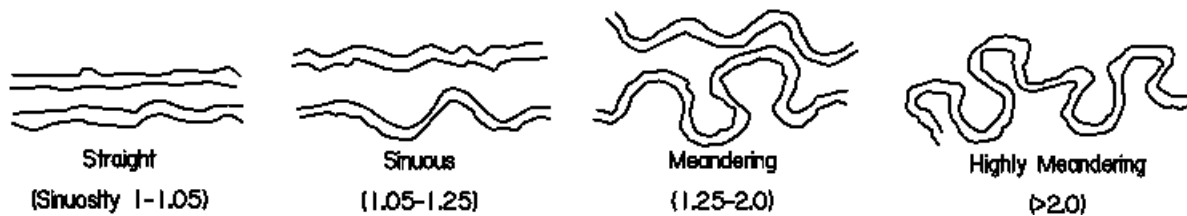

Figure 7-3. Various Degrees of Sinuosity

Straight channels are sinuous to the extent that the thalweg usually oscillates transversely within the low flow channel, and the current is deflected from one side to the other. The current oscillation usually results in the formation of pools on the outside of bends while lateral bars, resulting from deposition, form on the inside of the bends as shown in Figure 7-1, diagrams 2 and 3b.

Straight reaches of alluvial channels may be only a temporary condition. Aerial photography and topographic maps may reveal former locations of the channel and potential directions of further movement.

Braided Streams. Braiding is caused by bank caving and by large quantities of sediment load that the stream is unable to transport (see Figure 7-4). Deposition occurs when the supply of sediment exceeds the stream's transport capacity. As the streambed aggrades from deposition, the downstream channel reach develops a steeper slope, resulting in increased velocities. Multiple channels develop on the milder upstream slope as additional sediment is deposited within the main channel.

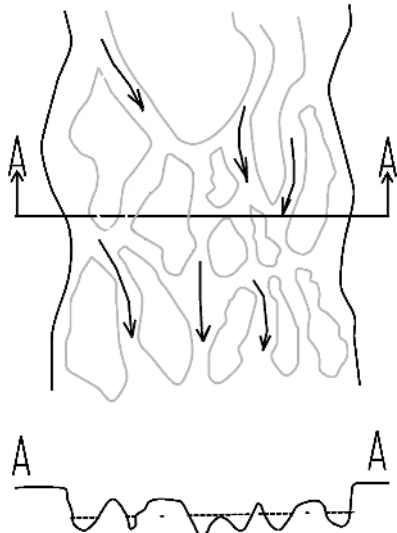

Figure 7-4. Plan View and Cross Section of a Braided Stream

The interlaced channels cause the overall channel system to widen, resulting in additional bank erosion. The eroded material may be deposited within the channel to form bars that may become stabilized islands. At flood stage, the flow may inundate most of the bars and islands, resulting in the complete destruction of some and changing the location of others. A braided stream is generally unpredictable and difficult to stabilize because it changes alignment rapidly, is subject to degradation and aggradation, and is very wide and shallow even at flood stage.

Meandering Streams. A meandering stream consists of alternating S-shaped bends (see Figure 7-5). In alluvial streams, the channel is subject to both lateral and longitudinal movement through the formation and destruction of bends.

Bends are formed by the process of erosion and sloughing of the banks on the outside of bends and by the corresponding deposition of bed load on the inside of bends to form point bars. The point bar constricts the bend and causes erosion in the bend to continue, accounting for the lateral and longitudinal migration of the meandering stream (Figure 7-5).

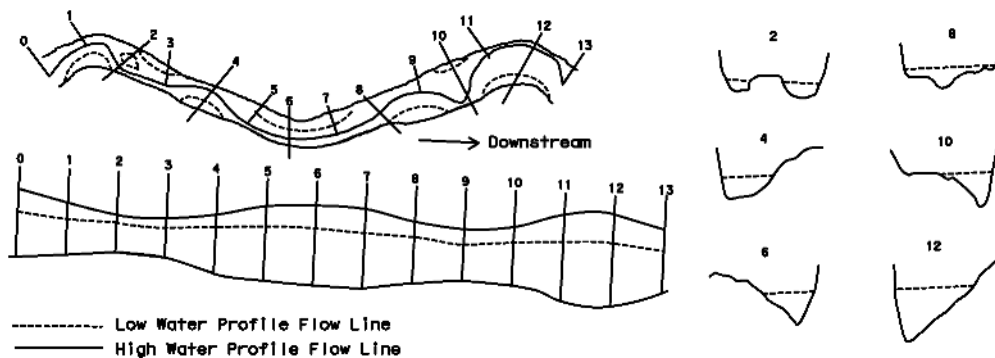

Figure 7-5. Plan View and Cross Section of a Meandering Stream

As a meandering stream moves along the path of least resistance, the bends move at unequal rates because of differences in the erodibility of the banks and floodplain. Bends are ultimately cut off, resulting in oxbow lakes (see below).

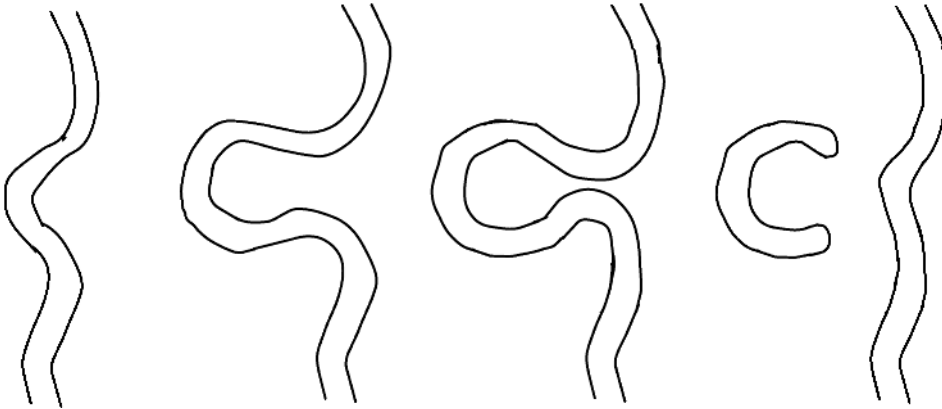

Figure 7-6. Migration Leading to Formation of Oxbow Lake

After a cutoff is formed, the stream gradient is steeper, the stream tends to adjust itself upstream and downstream, and a new bend may develop. Compare aerial photographs taken over a period of years to estimate the rate and direction of the meander movement. Local history may also help to quantify the rate of movement.

Modification to Meandering

Modification of an alluvial channel from its natural meandering tendency into a straight alignment usually requires confinement within armored banks because the channel may be very unstable. Straightening meandering channels can result in steeper gradients, degradation, and bank caving upstream as the stream attempts to reestablish equilibrium. The eroded material will be deposited downstream, resulting in reduced stream slopes, reduced sediment transport capacity, and possible braiding. When a channel is straightened without armor banks, the current will tend to oscillate transversely and initiate the formation of bends. Eventually, even protected straight channel reaches may be destroyed as a result of the natural migration of meanders upstream of the modified channel.

Graded Stream and Poised Stream Modification

Graded streams and poised streams are dynamically balanced, and any change altering that condition may lead to action by the stream to reestablish the balance. For example, if the channel gradient is increased, as occurs with a cutoff, the sediment transport capacity of the flow is increased and additional scouring results, thereby reducing the slope. The transport capacity of the downstream reach has not been altered; therefore, the additional sediment load carried downstream is deposited as a result of upstream scour. As the aggradation progresses, the stream slope below the deposition is increased, and the transport capacity is adjusted to the extent required to carry the

additional material through the entire reach. This process continues until a new balance is achieved, and the effect could extend a considerable distance upstream and downstream of the cutoff.

Modification Guidelines

It may be necessary to modify a stream in order to make it more compatible with the highway facility and the physical constraints imposed by local terrain or land use. The modifications may involve changes in alignment or conveyance. Changes may be necessary to accommodate the highway requirements, but they must be evaluated to assess short-term and long-term effects on the stream system.

Background data on the existing stream should be available from previously completed planning and location studies, and a preliminary highway design should be available in sufficient detail to indicate the extent of required channel modifications.

Certain types of streams may have a very wide threshold of tolerance to changes in alignment, grade, and cross-section. In contrast, small changes can cause significant impacts on sensitive waterways. An analysis of the tolerance to change may reveal that necessary modifications will not have detrimental results.

If you recognize detrimental effects, develop plans to mitigate the effects to within tolerable limits. You can enhance certain aspects of an existing stream system, often to the economic benefit of the highway. The following are examples of ways to enhance stream systems:

- ◆ Control active upstream headcutting (degradation due to abrupt changes in bed elevation) with culverts or check dams so that many hectares of land along the stream banks will not be lost and the highway facility will be protected from the headcutting.
- ◆ Coordinate and cooperate with fish and wildlife agency personnel, adapt or modify stabilization measures necessary to protect the highway while improving aquatic habitat.

Realignment Evaluation Procedure

The realignment of natural streams may disrupt the balance of the natural system. When evaluating stream modifications, use the following procedure:

1. Establish slope, section, meander pattern and [stage-discharge relationship](#) for present region.
2. Determine thresholds for changes in the various regime parameters.
3. Duplicate the existing regime, where possible, but keep within the established tolerances for change, where duplication is not practical or possible.

Stream realignment may occasionally decrease channel slope; more often, the modification will increase the channel gradient. A localized increase in channel slope may introduce channel responses that are reflected for considerable distances upstream and downstream of the project.

Response Possibilities and Solutions

Increased Slope. The following are possible responses to increased slope:

- ◆ The stream response may be in the form of a regime change from a meandering to a braided channel, or sediment transport through the steepened reach may be increased enough to cause degradation upstream of the realignment and aggradation downstream.
- ◆ Banks may become unstable and require structural stabilization measures to prevent erosion.
- ◆ Tributary channels entering the steepened main channel may be subject to headcutting, with deposition occurring at or downstream of the junction.

The following are possible solutions to increased slope:

- ◆ You may use grade control structures (such as check dams, weirs, or chutes) to minimize increases in gradient, provided there is some assurance that the normal meandering tendency of the channel will not bypass these structures in time.
- ◆ If topography permits, use meanders to reduce the stream gradient to existing or threshold levels. These meanders may require stabilization to assure continued effectiveness and stability.

Encroachment. Highway locations or modifications in certain terrain conditions may result in an encroachment such as that illustrated in Figure 7-7.

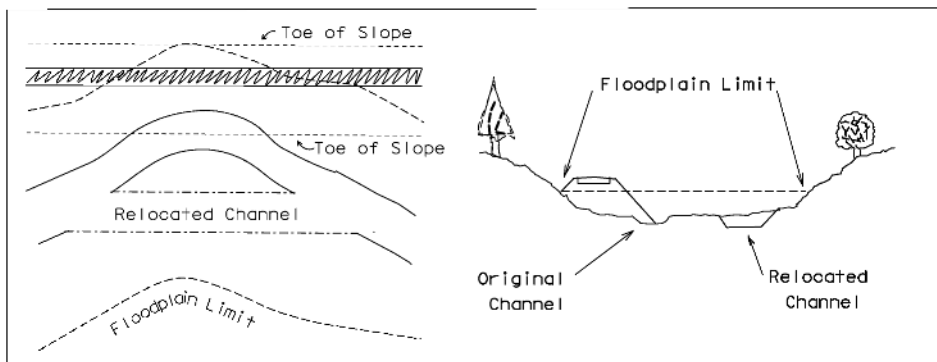

Figure 7-7. Highway Encroachment on Natural Streams and Stream Relocation

This type of channel realignment may require providing a channel of sufficient section to convey both normal and flood flow within the banks formed by the roadway and the floodplain. The low flow channel may require realignment, in which case a pilot channel could approximate the existing channel characteristics of width, depth, gradient, and bottom roughness. Where no pilot channel is provided, the average daily flow is likely to spread over a much wider section, and flow depth will be reduced in such a way that water temperature, pool formation, and sediment transport are adversely affected. These modifications may result in a braided channel condition and hamper the re-establishment of the natural aquatic environment.

Clearing of vegetation along stream banks may remove root systems that have contributed to bank stability. Clearing and grubbing reduces the bank and floodplain roughness and contributes to

higher velocities and increased erosion potential for those areas. However, the limited clearing of adjacent right-of-way involved with transverse encroachments or crossings does not normally affect the overall conveyance capacity of a channel to any significance.

A water surface profile analysis is necessary to establish the [stage-discharge relationship](#) for channels with varying roughness characteristics across the channel. The [Slope Conveyance Method](#) of estimating stage-discharge relationships can be subject to significant error if the typical section used does not represent the actual conditions upstream and downstream of the crossing site. Therefore, the [Standard Step Backwater Method](#) is recommended. (See [Section 6](#) for more details on these methods.)

Channel enlargement or cleanout through a limited channel reach is sometimes proposed in an effort to provide additional stream capacity. If the stage of the stream at the proposed highway site is controlled by downstream conditions, there can be limited or possibly no benefits derived from localized clearing.

Environmental Mitigation Measures

The potential environmental impacts and the possible need for stream impact mitigation measures should be primary considerations. (See [Environmental Assessments](#) in Section 2 for more information.) Mitigation practices are not generally warranted but may be mandated by the cognizant regulatory agency. As such, you may need to coordinate with Texas fish and wildlife agencies before determining mitigation. Consult the Environmental Affairs Division and the Design Division, Hydraulic Branch, to determine the need for mitigation when you deem stream modifications necessary.

Channel modifications may be necessary and also can provide environmental enhancement (see the previous [Modification Guidelines](#) subsection). Also, channel modifications that are compatible with the existing aquatic environment can sometimes be constructed at little or no extra cost.

There will be less aquatic habitat where a channel is shortened to accommodate highway construction. This not only decreases the aquatic biomass, but also reduces the amount of surface water available for recreation and sport fishing. Estimate the significance of this effect by comparing the amount of surface water area, riparian and upland wetland area, and stream length that will be lost with the existing amount in the geographic area. If there will be a loss, particularly of wetlands, resource and regulatory agencies may raise objections in light of the national “no net loss” policy currently prevailing. In some instances, such habitat loss may be acceptable when combined with mitigation measures, but such measures should prevent habitat damage beyond the channel change limits.

Enhancement of the channel may be accomplished during stream reconstruction at little additional cost, and perhaps at less cost where reconstruction is essential to the needs of the highway project.

It may even be possible to reconstruct the surface water resource in one of the following manners that eliminates an existing environmental problem:

- ◆ incorporating sinuosity into a straight stream reach
- ◆ relocating the channel to avoid contamination from minerals or other pollution sources
- ◆ adjusting flow depth and width to better utilize low flows
- ◆ providing an irregular shaped channel section to encourage overhanging bank
- ◆ improving the riparian vegetation.

The most common practices are using a drop-type grade control structure (check dam), maintaining the existing channel slope, and increasing the channel change length by constructing an artificial meander.

Culverts can provide another alternative similar to using drop structures. You can increase the culvert flowline slope to accommodate the elevation difference caused by shortening a channel. The increased erosion associated with steep culverts is localized at the outlet that can be protected.

Simulate the existing channel cross section if it is relatively stable, has low flow depths and velocities, or has adequate minimum flow requirements.

Determine the cross-sectional shape by hydraulically analyzing simple and easy to construct shapes that approximate the preferred natural channel geometry. The analysis generally compares the stage-discharge, stage-velocity, and stage-sediment relationships of the natural channel with the modified channel.

Stream relocations may temporarily impair water quality. The problem is primarily sediment-related, except for those rare instances where adverse minerals or chemicals are exposed, diverted, or intercepted. With a channel relocation, the new channel should be constructed in dry conditions wherever possible. Following completion, the downstream end should be opened first to allow a portion of the new channel to fill as much as possible. Next, the upstream end should be opened slowly to minimize erosion and damage to habitat mitigation.

Where the channel relocation interferes with the existing channel, it may be desirable to construct rock and gravel dikes or to use other filtering devices or commercially available dikes to isolate the construction site, thereby limiting the amount of sediment entering the water.

Countermeasures

Many streams have a strong propensity to meander. The sinuosity of the main channel is a general characteristic of a stream and can vary with the discharge and the type of soil that the stream passes through. The erosive force of the stream water forms meanders as it undercuts the main channel bank. The bank support is lost and material caves into the water to be deposited downstream. As the

erosion on the outer bend of the meander migrates in a downstream direction, material from upstream deposits on the inside of the bend. This progression of stream meandering can have serious effects on highway crossings. This migration often threatens approach roadway embankment and bridge headers such as shown in Figure 7-8.

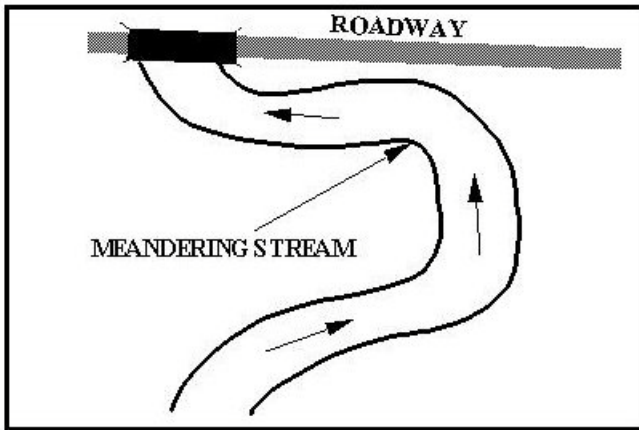

Figure 7-8. Meandering Stream Threatening Bridge and Approach Roadway

In order to protect the roadway from the threat of meanders, yet remain synchronous with nature, it is important to devise countermeasures that are environmentally sound, naturally acting, economically viable, and physically effective.

Possible countermeasures include the following:

- ◆ Bridge lengthening -- With reference to the example given in Figure 7-8, lengthening the bridge may not always be cost-effective as a countermeasure to the damage potential from the meander. In this example, the natural meandering course of the river threatens both the bridge and the approach roadway.
- ◆ Bridge relocation – In extreme situations, it may be necessary to relocate the bridge. Generally, it is good practice to locate the bridge crossing on a relatively straight reach of stream between bends.
- ◆ River training or some type of erosion control – River training or some type of erosion control may be more effective and economical. Designers have used several measures and devices successfully in Texas to counter the effects of serious stream meandering.
- ◆ Linear structures -- When it is not practical to locate the bridge on a relatively straight reach of stream, countermeasures such as spur or jetty type control structures may be needed (see Figure 7-9). These are sometimes referred to as linear structures, permeable or impermeable, projecting into the channel from the bank to alter flow direction, protect the channel bank, induce deposition, and reduce flow velocity along the bank.

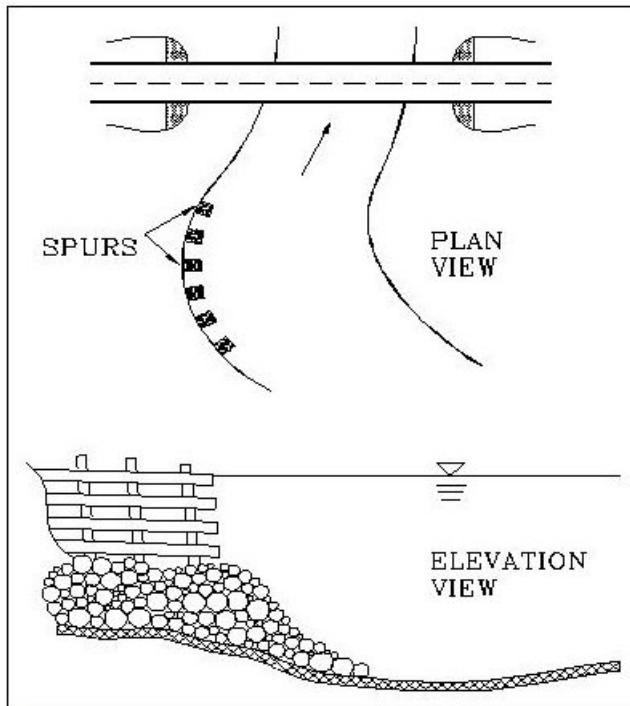

Figure 7-9. Permeable Fence Spurs as Meander Migration Countermeasures

Control structures may or may not cause the typical cross section of flow in a meandering stream to become more symmetrical. For many locations, countermeasures may not be required for several years because of the time required for the bend to move to a location where it begins to threaten the highway facility. In other streams, however, bends may migrate at such a rate that the highway is threatened within a few years or after a few flood events. In such cases, the countermeasure should be installed during initial construction.

Altered Stream Sinuosity

In some instances, stabilizing channel banks at a highway stream crossing can cause a change in the channel cross section and may alter the stream sinuosity winding upstream of the stabilized banks. Figure 7-10 illustrates meander migration in a natural stream. If sinuosity increases due to artificial stream stabilization, then meander amplitude may increase. Meander radii in other parts of the reach may become smaller and deposition may occur because of reduced slopes. The channel width-depth ratio may increase as a result of bank erosion and deposition. Ultimately, cutoffs can occur.

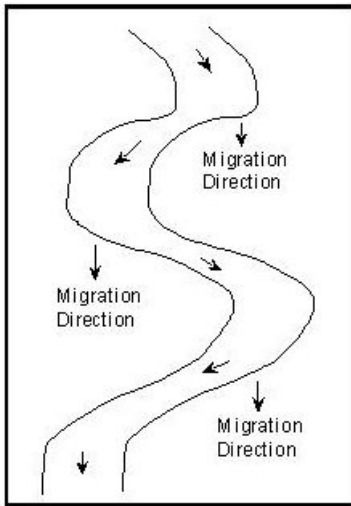

Figure 7-10. Meander Migration in a Natural Stream

Refer to *Design of Spur-Type Streambank Stabilization Structures*, [FHWA/RD-84/101](#) and *Stream Stability at Highway Structures*, [HEC-20](#), for further design considerations, guidelines, and procedures for the various types of stream stabilization and meander countermeasures used and recommended by the department.

Stabilization and Bank Protection

Highway embankments constructed within a floodplain may require stabilization to resist erosion during flood events. You may design and construct embankment stabilization with the initial roadway project where the need is obvious or the risk of damage is high. In other locations the following factors may warrant that installation of embankment stabilization to be delayed until a problem actually develops as follows:

- ◆ economic considerations
- ◆ availability of materials
- ◆ probability of damage.

Highway channel stabilization measures are usually local in nature. Engineers design them primarily to protect the highway facility from attack by a shifting channel or where the floodplain adjacent to the facility is highly erodible.

If a highway location adjacent to a stream cannot be avoided, you should evaluate protective measures to determine the measure best suited to the situation. These alternatives may include channel change, roadway embankment protection, stream bank stabilization, and stream-training works.

Channel stabilization should be considered only when it is economically justified and one or more of the following basic purposes will be accomplished:

- ◆ prevent loss or damage of the highway facility and associated improvement
- ◆ reduce maintenance requirements
- ◆ achieve secondary benefits such as beautification, recreation, and the preservation or establishment of fish and wildlife habitat.

Stabilization measures at the highway site may not be successful if the section is located within long reaches of unstable channel. Local stabilization often results in high maintenance costs and repetitive reconstruction. A stream may respond to local stabilization by changing flow regime or attacking the unprotected bed or opposite bank. The potential for these occurrences should be considered. However, if bank erosion occurs only at isolated locations, stabilization measures at these locations are probably an economical solution even though a period of repetitive maintenance may follow.

Revetments

Generally, revetments are located on the outside bank of bends where bank recession or erosion is most active as a result of impinging flow (see Figure 7-11). They may be required elsewhere to protect an embankment from wave wash or flood attack.

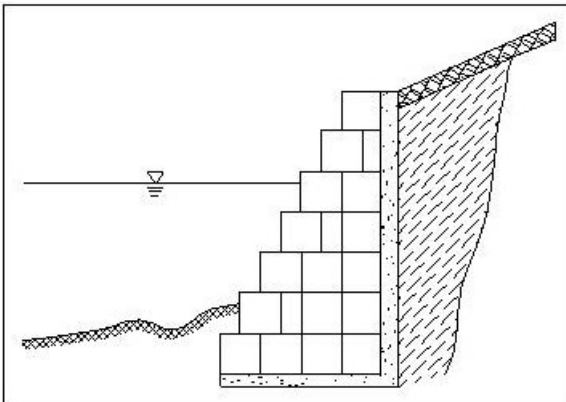

Figure 7-11. Gabions Used as Revetment

The segment of revetment placed above the annual flood elevation may differ in design from the segment located below that elevation due to the conditions affecting construction, the types of materials available, and the differences in the duration and intensity of attack. The higher segment is termed upper bank protection, and the lower segment is called subaqueous protection. Both are required to prevent bank recession, and the upper bank protection may be extended to a sufficient height to protect against wave action. For smaller streams and rivers, the upper and subaqueous protections are usually of the same design and are placed in a single operation.

The banks on which revetments will be placed should be graded to slopes that will be stable when saturated, and an adequate filter system should be incorporated to prevent loss of bank material through the protective revetment.

The type of filter system used depends on slope stability, bank material, type of revetment, and availability of filter materials.

Filter materials may consist of sand, gravel, or woven or non-woven synthetic filter cloth.

Numerous materials have been used for bank protection, including dumped rock, Portland cement concrete, sacked sand-cement, soil cement, gabions, and precast blocks.

Section 5 — Channel Analysis Guidelines

Stage-Discharge Relationship

A stage-discharge curve is a graph of water surface elevation versus flow rate in a channel. A stage-discharge curve is shown in Figure 7-12. You may compute various depths of the total discharge for the stream, normal flow channel, and floodplain.

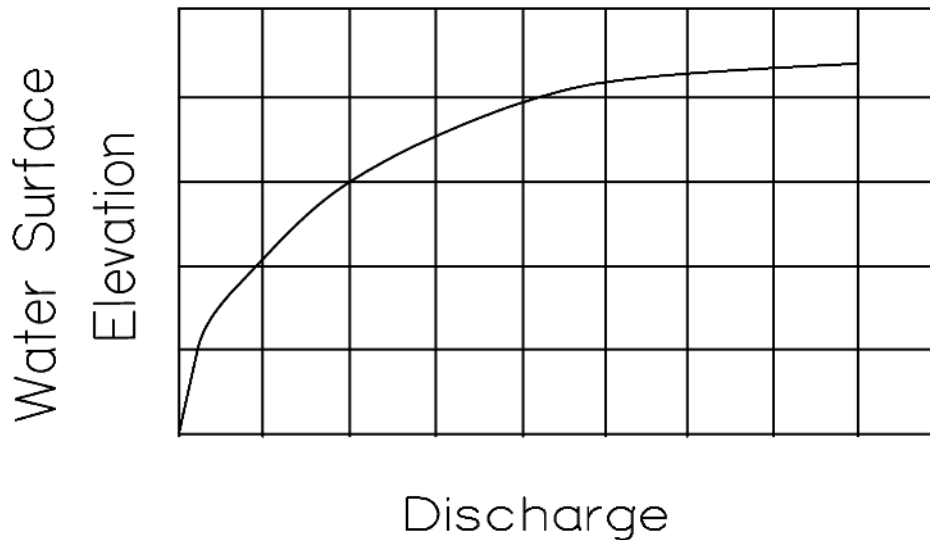

Figure 7-12. Typical Stage Discharge Curve

(See [Manning’s Equation for Uniform Flow](#) and [Stage-Discharge Determination](#).) The data, plotted in graphic form (sometimes termed a “rating curve”), gives you a visual display of the relationship between water surface elevations and discharges.

An accurate stage-discharge relationship is necessary for channel design to evaluate the interrelationships of flow characteristics and to establish alternatives for width, depth of flow, freeboard, conveyance capacity and type, and required degree of stabilization.

The stage-discharge relationship also enables you to evaluate a range of conditions as opposed to a preselected design flow rate.

Examine the plot of stage-discharge carefully for evidence of the “switchback” characteristic described below. Also, examine the plot to determine whether or not it is realistic. For example, a stream serving a small watershed should reflect reasonable discharge rates for apparent high water elevations.

Switchback

If you improperly subdivide the cross section, the mathematics of Manning's Equation may cause a switchback. A switchback results when the calculated discharge decreases with an associated increase in elevation or depth (see Manning's Equation for Uniform Flow in Chapter 6, [Equation 6-3](#) and Figure 7-13). A small increase in depth can result in a small increase in cross-sectional area and large increase in wetted perimeter and a net decrease in the hydraulic radius. The discharge computed using the smaller hydraulic radius and the slightly larger cross-sectional area is lower than the previous discharge for which the water depth was lower. Use more subdivisions within such cross sections in order to avoid the switchback.

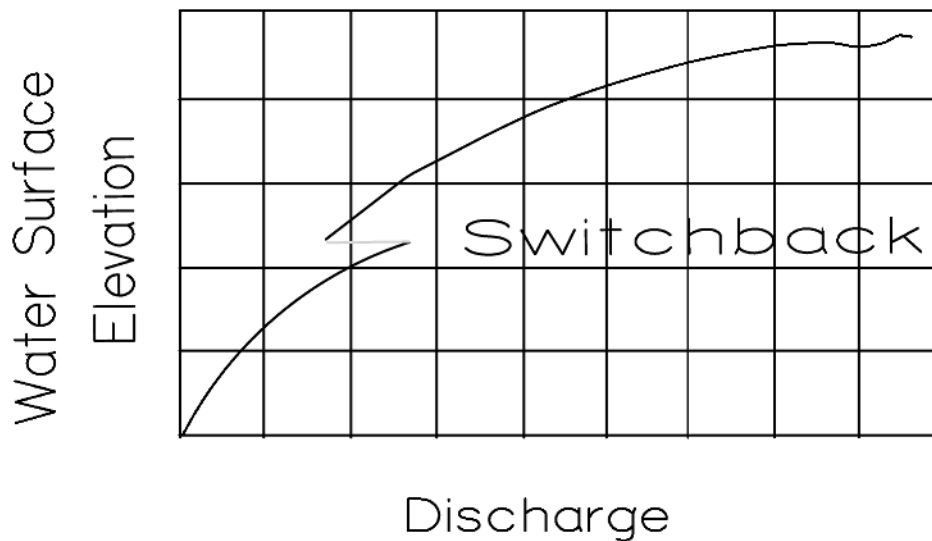

Figure 7-13. Switchback in Stage Discharge Curve

A switchback can occur in any type of conveyance computation. Computer logic can be seriously confused if a switchback occurs in any cross section being used in a program. For this reason, always subdivide the cross section with respect to both roughness and geometric changes. Note that the actual n -value may be the same in adjacent subsections. However, too many subdivisions can result in problems, too. (See Chapter 6 for more information.)

Section 6 — Channel Analysis Methods

Introduction

The depth and velocity of flow are necessary for the design and analysis of channel linings and highway drainage structures. The depth and velocity at which a given discharge flows in a channel of known geometry, roughness, and slope can be determined through hydraulic analysis. The following two methods are commonly used in the hydraulic analysis of open channels:

- ◆ [Slope Conveyance Method](#)
- ◆ [Standard Step Backwater Method](#).

Generally, the Slope Conveyance Method requires more judgment and assumptions than the Standard Step Method. In many situations, however, use of the Slope Conveyance Method is justified, as in the following conditions:

- ◆ standard roadway ditches
- ◆ culverts
- ◆ storm drain outfalls.

Slope Conveyance Method

The Slope Conveyance Method, or Slope Area Method, has the advantages of being a relatively simple, usually inexpensive and expedient procedure. However, due to the assumptions necessary for its use, its reliability is often low. The results are highly sensitive to both the longitudinal slope and roughness coefficients that are subjectively assigned. This method is often sufficient for determining tailwater (TW) depth at non-bridge class culvert outlets and storm drain outlets.

The procedure involves an iterative development of calculated discharges associated with assumed water surface elevations in a typical section. The series of assumed water surface elevations and associated discharges comprise the stage-discharge relationship. When stream gauge information exists, a measured relationship (usually termed a “rating curve”) may be available.

You normally apply the Slope Conveyance Method to relatively small stream crossings or those in which no unusual flow characteristics are anticipated. The reliability of the results depends on accuracy of the supporting data, appropriateness of the parameter assignments (n-values and longitudinal slopes), and your selection of the typical cross section.

If the crossing is a more important one, or if there are unusual flow characteristics, use some other procedure such as the [Standard Step Backwater Method](#).

A channel cross section and associated roughness and slope data considered typical of the stream reach are required for this analysis. A typical section is one that represents the average characteristics of the stream near the point of interest. While not absolutely necessary, this cross section should be located downstream from the proposed drainage facility site. The closer to the proposed site a typical cross section is taken, the less error in the final water surface elevation.

You should locate a typical cross section for the analysis. If you cannot find such a cross section, then you should use a “control” cross section (also downstream). (Known hydraulic conditions, such as sluice gates or weirs exist in a control cross section.) The depth of flow in a control cross section is controlled by a constriction of the channel, a damming effect across the channel, or possibly an area with extreme roughness coefficients.

The cross section should be normal to the direction of stream flow under flood conditions.

After identifying the cross section, apply Manning’s [roughness coefficients](#) (n-values). (See [Equation 6-3](#) and Chapter 6 for more information.) Divide the cross section with vertical boundaries at significant changes in cross-section shape or at changes in vegetation cover and roughness components. (See Chapter 6 for suggestions on [subdividing cross sections](#).)

Manning’s Equation for Uniform Flow (see Chapter 6 and Equation 6-3) is based on the slope of the energy grade line, which often corresponds to the average slope of the channel bed. However, some reaches of stream may have an energy gradient quite different from the bed slope during flood flow.

Determine the average bed slope near the site. Usually, the least expensive and most expedient method of slope-determination is to survey and analyze the bed profile for some distance in a stream reach. Alternately, you may use topographic maps, although they are usually less accurate.

Slope Conveyance Procedure

The calculation of the stage-discharge relationship should proceed as described in this section. The Water Surface [Elevation tables](#) represent the progression of these calculations based on the cross section shown in [Figure 7-14](#). The result of this procedure is a stage-discharge curve, as shown in [Figure 7-15](#). You can then use the design discharge or any other subject discharge as an argument to estimate (usually done by interpolation) an associated water surface elevation.

1. Select a trial starting depth and apply it to a plot of the cross section.
2. Compute the area and [wetted perimeter weighted n-value](#) (see Chapter 6) for each submerged subsection.
3. Compute the subsection discharges with Manning’s Equation. Use the subsection values for roughness, area, wetted perimeter, and slope. (See Equation 7-1). The sum of all of the incremental discharges represents the total discharge for each assumed water surface elevation.

Note. Compute the average velocity for the section by substituting the total section area and total discharge into the continuity equation.

$$V = \frac{Q}{A}$$

Equation 7-4.

4. Tabulate or plot the water surface elevation and resulting discharge (stage versus discharge).
5. Repeat the above steps with a new channel depth, or add a depth increment to the trial depth. The choice of elevation increment is somewhat subjective. However, if the increments are less than about 0.25 ft. (0.075 m), considerable calculation is required. On the other hand, if the increments are greater than 1.5 ft. (0.5 m), the resulting stage-discharge relationship may not be detailed enough for use in design.
6. Determine the depth for a given discharge by interpolation of the stage versus discharge table or plot.

The following x and y values apply to Figure 7-14:

X and Y Values for Figure 7-14

X	Y
0	79
2	75
18	72
20	65
33	65
35	70
58	75
60	79

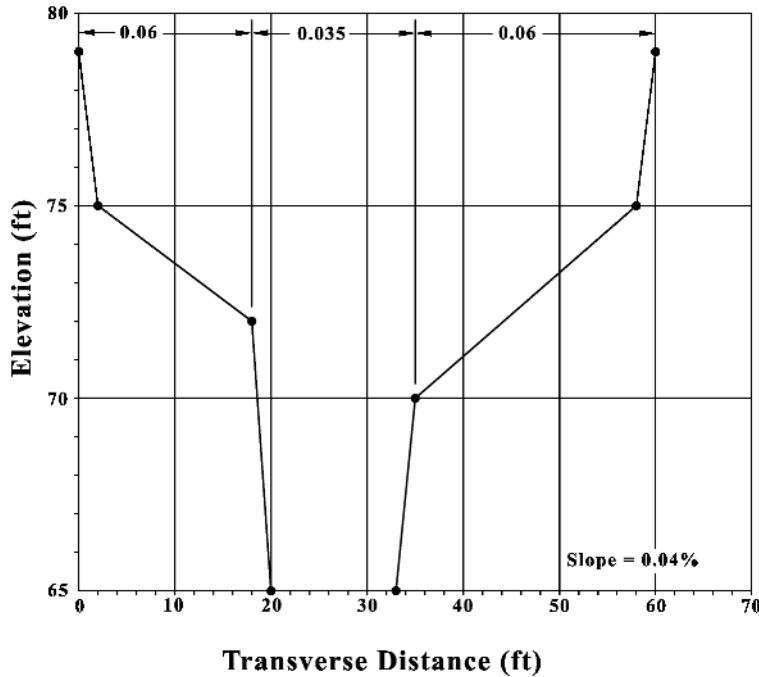

Figure 7-14. Slope Conveyance Cross Section

Water Surface Elevation of 66 ft.

	Subsection L	Subsection C	Subsection R	Full Section
Area (ft ²)	0	13.34	0	13.34
Wetted Perimeter (ft)	0	15.12	0	
Hydraulic Radius (ft)		0.88		
n	0.060	0.035	0.060	
Q (cfs)		10.43		10.43
Velocity (fps)		0.78		0.78

Water Surface Elevation of 79 ft.

	Subsection L	Subsection C	Subsection R	Full Section
Area (ft ²)	92.00	226.00	153.50	471.5
Wetted Perimeter (ft)	20.75	25.67	28.01	
Hydraulic Radius (ft)	4.43	8.81	5.48	
n	0.060	0.035	0.060	
Q (cfs)	122.98	818.33	236.34	1177.66
Velocity (fps)	1.34	3.62	1.54	2.50

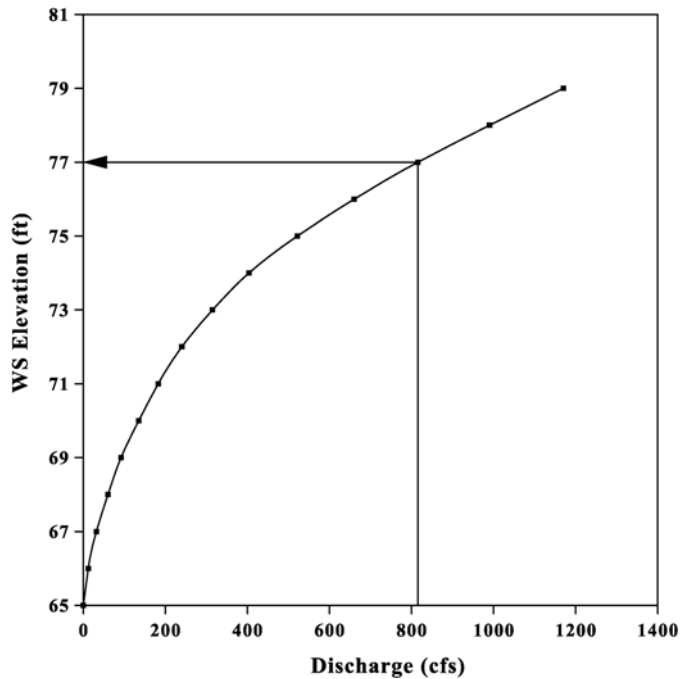

Figure 7-15. Stage Discharge Curve for Slope Conveyance

Standard Step Backwater Method

The Step Backwater Method, or Standard Step Method, uses the energy equation to “step” the stream water surface along a profile (usually in an upstream direction because most Texas streams exhibit subcritical flow). This method is typically more expensive to complete but more reliable than the Slope-Conveyance Method.

The manual calculation process for the Standard Step Method is cumbersome and tedious. With accessibility to computers and the availability of numerous algorithms, you can accomplish the usual channel analysis by Standard Step using suitable computer programs.

A stage-discharge relationship can be derived from the water surface profiles for each of several discharge rates.

Ensure that the particular application complies with the limitations of the program used.

Use the Standard Step Method for analysis in the following instances:

- ◆ results from the Slope-Conveyance Method may not be accurate enough
- ◆ the drainage facility’s level of importance deserves a more sophisticated channel analysis
- ◆ the channel is highly irregular with numerous or significant variations of geometry, roughness characteristics, or stream confluences
- ◆ a controlling structure affects backwater.

This procedure applies to most open channel flow, including streams having an irregular channel with the cross section consisting of a main channel and separate overbank areas with individual n -values. Use this method either for supercritical flow or for subcritical flow.

Standard Step Data Requirements

At least four cross sections are required to complete this procedure, but you often need many more than three cross sections. The number and frequency of cross sections required is a direct function of the irregularity of the stream reach. Generally speaking, the more irregular the reach, the more cross sections you may require. The cross sections should represent the reach between them. A system of measurement or stationing between cross sections is also required. Evaluate roughness characteristics (n -values) and associated sub-section boundaries for all of the cross sections. Unfortunately, the primary way to determine if you have sufficient cross sections is to evaluate the results of a first trial.

The selection of cross sections used in this method is critical. As the irregularities of a stream vary along a natural stream reach, accommodate the influence of the varying cross-sectional geometry. Incorporate transitional cross sections into the series of cross sections making up the stream reach. While there is considerable flexibility in the procedure concerning the computed water surface profile, you can use knowledge of any controlling water surface elevations.

Standard Step Procedure

The Standard Step Method uses the Energy Balance Equation, [Equation 6-11](#), which allows the water surface elevation at the upstream section (2) to be found from a known water surface elevation at the downstream section (1). The following procedure assumes that cross sections, stationing, discharges, and n -values have already been established. Generally, for Texas, the assumption of subcritical flow will be appropriate to start the process. Subsequent calculations will check this assumption.

1. Select the discharge to be used. Determine a starting water surface elevation. For subcritical flow, begin at the most downstream cross section. Use one of the following methods to establish a starting water surface elevation for the selected discharge: a measured elevation, the Slope-Conveyance Method to determine the stage for an appropriate discharge, or an existing (verified) rating curve.
2. Referring to [Figure 6-1](#) and [Equation 6-11](#), consider the downstream water surface to be section 1 and calculate the following variables:
 - z_1 = flowline elevation at section 1
 - y_1 = tailwater minus flowline elevation
 - α = kinetic energy coefficient (For simple cases or where conveyance does not vary significantly, it may be possible to ignore this coefficient.)

3. From cross section 1, calculate the area, A_1 . Then use [Equation 6-1](#) to calculate the velocity, v_1 , for the velocity head at A_1 . The next station upstream is usually section 2. Assume a depth y_2 at section 2, and use y_2 to calculate z_2 and A_2 . Calculate, also, the velocity head at A_2 .
4. Calculate the friction slope (s_f) between the two sections using Equation 7-5 and Equation 7-6:

$$s_f = \left(\frac{Q}{K_{ave}} \right)^2$$

Equation 7-5.

where:

$$K_{ave} = \frac{K_1 + K_2}{2} = 0.5 \left(\frac{ZA_1 R_1^{\frac{2}{3}}}{n_1} + \frac{ZA_2 R_2^{\frac{2}{3}}}{n_2} \right)$$

Equation 7-6.

5. Calculate the friction head losses (h_f) between the two sections using

$$h_f = S_{ave}L$$

Equation 7-7.

where:

L = Distance in ft. (or m) between the two sections

6. Calculate the kinetic energy correction coefficients (α_1 and α_2) using [Equation 6-10](#).
7. Where appropriate, calculate expansion losses (h_e) using Equation 7-8 and contraction losses (h_c) using Equation 7-9 (Other losses, such as bend losses, are often disregarded as an unnecessary refinement.)

$$h_e = K_e \frac{\Delta V^2}{2g}$$

Equation 7-8.

where:

$K_e = 0.3$ for a gentle expansion

$K_e = 0.5$ for a sudden expansion

$$h_c = K_c \frac{\Delta V^2}{2g}$$

Equation 7-9.

where:

$K_c = 0.1$ for a gentle contraction

$K_c = 0.3$ for a sudden contraction

8. Check the energy equation for balance using Equation 7-10 and Equation 7-11.

$$L = z_2 + y_2 + \alpha_2 \frac{V_2^2}{2g}$$

Equation 7-10.

$$R = z_1 + y_1 + \alpha_1 \frac{V_1^2}{2g} + h_f + h_e + h_c$$

Equation 7-11.

The following considerations apply:

- if $L=R$ within a reasonable tolerance, then the assumed depth at Section 1 is okay. This will be the calculated water surface depth at Section 1; proceed to Step (9)
 - if $L \neq R$, go back to Step (3) using a different assumed depth.
9. Determine the [critical depth](#) (d_c) at the cross section and find the uniform depth (d_u) by iteration. If, when running a supercritical profile, the results indicate that critical depth is greater than uniform depth, then it is possible the profile at that cross section is supercritical. For subcritical flow, the process is similar but the calculations must begin at the upstream section and proceed downstream.
10. Assign the calculated depth from Step (8) as the downstream elevation (Section 1) and the next section upstream as Section 2, and repeat Steps (2) through (10).
11. Repeat these steps until all of the sections along the reach have been addressed.

Profile Convergence

When you use the [Standard Step Backwater Method](#) and the starting water surface elevation is unknown or indefinite, you can use a computer to calculate several backwater profiles based on several arbitrary starting elevations for the same discharge. If you plot these profiles, as shown in Figure 7-16, they will tend to converge to a common curve at some point upstream because each successive calculation brings the water level nearer the uniform depth profile.

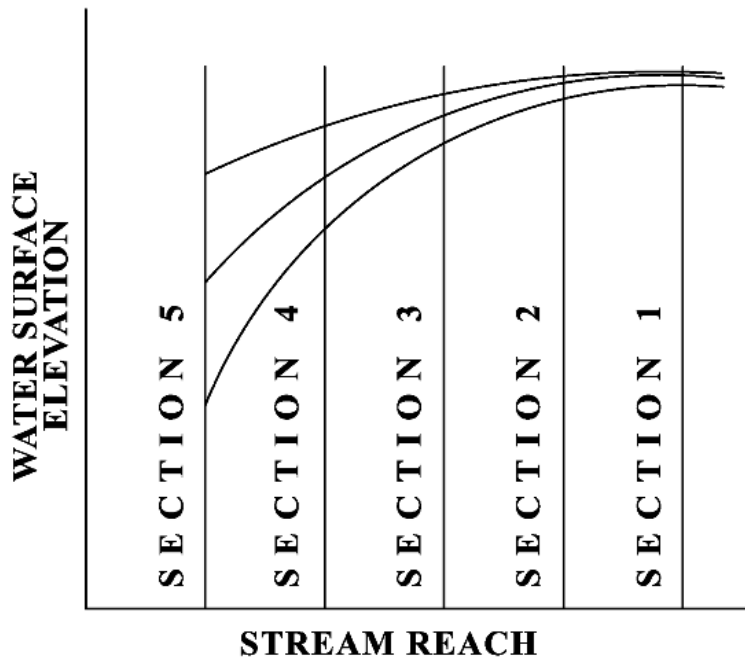

Figure 7-16. Water Surface Profile Convergence

The purpose of plotting the curves and finding the convergence point is to determine where the proposed structure site is in reference to the convergence point. If the site is in the vicinity or upstream of the convergence point, you have started the calculations far enough downstream to define a proper tailwater from an unknown starting elevation. Otherwise, you may have to begin the calculations at a point further downstream by using additional cross sections.

Chapter 8 — Culverts

Contents:

[Section 1 — Introduction](#)

[Section 2 — Design Considerations](#)

[Section 3 — Hydraulic Operation of Culverts](#)

[Section 4 — Improved Inlets](#)

[Section 5 — Velocity Protection and Control Devices](#)

[Section 6 — Special Applications](#)

Section 1 — Introduction

Definition and Purpose

A culvert conveys surface water through a roadway embankment or away from the highway right-of-way (ROW) or into a channel along the ROW. In addition to the hydraulic function, the culvert must also support construction and highway traffic and earth loads; therefore, culvert design involves both hydraulic and structural design. The hydraulic and structural designs must be such that minimal risks to traffic, property damage, and failure from floods prove the results of good engineering practice and economics. Culverts are considered minor structures, but they are of great importance to adequate drainage and the integrity of the facility. This chapter describes the hydraulic aspects of culvert design, construction and operation of culverts, and makes references to structural aspects only as they are related to the hydraulic design.

Culverts, as distinguished from bridges, are usually covered with embankment and are composed of structural material around the entire perimeter, although some are supported on spread footings with the streambed or concrete riprap channel serving as the bottom of the culvert. For economy and hydraulic efficiency, engineers should design culverts to operate with the inlet submerged during flood flows, if conditions permit. Bridges, on the other hand, are not covered with embankment or designed to take advantage of submergence to increase hydraulic capacity, even though some are designed to be inundated under flood conditions. Any culvert with a clear opening of more than 20-feet, measured along the center of the roadway between inside of end walls, is considered a bridge by FHWA, and is designated a bridge class culvert. (See Chapter 9, [Section 1](#)). This chapter addresses structures designed hydraulically as culverts, regardless of length.

At many locations, either a bridge or a culvert fulfills both the structural and hydraulic requirements for the stream crossing. The appropriate structure should be chosen based on the following criteria:

- ◆ construction and maintenance costs
- ◆ risk of failure
- ◆ risk of property damage
- ◆ traffic safety
- ◆ environmental and aesthetic considerations
- ◆ construction expedience.

Although the cost of individual culverts is usually relatively small, the total cost of culvert construction constitutes a substantial share of the total cost of highway construction. Similarly, culvert maintenance may account for a large share of the total cost of maintaining highway hydraulic fea-

tures. Improved traffic service and reduced cost can be achieved by judicious choice of design criteria and careful attention to the hydraulic design of each culvert.

Before starting culvert design, the site and roadway data, design parameters (including shape, material, and orientation), hydrology (flood magnitude versus frequency relation), and channel analysis (stage versus discharge relation) must be considered.

Construction

Culverts are constructed from a variety of materials and are available in many different shapes and configurations. When selecting a culvert, the following should be considered:

- ◆ roadway profiles
- ◆ channel characteristics
- ◆ flood damage evaluations
- ◆ construction and maintenance costs
- ◆ estimates of service life.

Numerous cross-sectional shapes are available. The most commonly used shapes are circular, pipe-arch and elliptical, box (rectangular), modified box, and arch. Shape selection should be based on the cost of construction, limitation on upstream water surface elevation, roadway embankment height, and hydraulic performance. Commonly used culvert materials include concrete (reinforced and non-reinforced), steel (smooth and corrugated), aluminum (smooth and corrugated), and plastic (smooth and corrugated).

The selection of material for a culvert depends on several factors that can vary considerably according to location. The following groups of variables should be considered:

- ◆ structure strength, considering fill height, loading condition, and foundation condition
- ◆ hydraulic efficiency, considering Manning's roughness, cross section area, and shape
- ◆ installation, local construction practices, availability of pipe embedment material, and joint tightness requirements
- ◆ durability, considering water and soil environment (pH and resistivity), corrosion (metallic coating selection), and abrasion
- ◆ cost, considering availability of materials.

The most economical culvert is the one that has the lowest total annual cost over the design life of the project. Culvert material selection should not be based solely on the initial cost. Replacement costs and traffic delay are usually the primary factors in selecting a material that has a long service life. If two or more culvert materials are equally acceptable for use at a site, including hydraulic

performance and annual costs for a given life expectancy, bidding the materials as alternates should be considered, allowing the contractor to make the most economical material selection.

Inlets

Several inlet configurations are utilized on culvert barrels. These include both prefabricated and constructed-in-place installations. Commonly used inlet configurations include the following:

- ◆ projecting culvert barrels
- ◆ cast-in-place concrete headwalls
- ◆ pre-cast or prefabricated end sections
- ◆ culvert ends mitered to conform to the fill slope.

When selecting various inlet configurations, structural stability, aesthetics, erosion control, and fill retention should be considered.

Culvert hydraulic capacity may be improved by selecting appropriate inlets. Because the natural channel is usually wider than the culvert barrel, the culvert inlet edge represents a flow contraction and may be the primary flow control. A more gradual flow transition lessens the energy loss and thus creates a more hydraulically efficient inlet condition. [Beveled inlet edges](#) are more efficient than square edges. [Side-tapered inlets](#) and [slope-tapered inlets](#), commonly referred to as improved inlets, further reduce head loss due to flow contraction. Depressed inlets, such as slope-tapered inlets, increase the effective head on the flow control section, thereby further increasing the culvert efficiency.

Section 2 — Design Considerations

Economics

A wide spectrum of flood flows with associated probabilities occurs at the culvert site during its service life. The benefits of constructing a large capacity culvert to accommodate all of these events with no detrimental flooding effects are normally outweighed by the initial construction costs. Therefore, an economic analysis of the trade-offs should be conducted.

The initial cost is only a small part of the total cost over the lifetime of the culvert. Understanding how the culvert operates at discharges other than the design discharge can help you define some of the longer-term operational costs.

The cost of traffic detours can be the most important if factors such as the cost of emergency vehicle response time or detour distance and cost of operation per vehicle mile are considered, especially if there is a large average daily traffic rate.

Reduced to an annual cost on the basis of the anticipated service life, the long-term costs of a culvert operation include the following:

- ◆ initial cost of the culvert
- ◆ cost of damage to the roadway
- ◆ cost of damage to the culvert and associated appurtenances
- ◆ cost of damage to the stream (approach and exit)
- ◆ cost of damage to upstream and downstream private or public property.

For minor stream crossings, the use of the Design Flood and Check Flood Standards table may preclude the need for a detailed economic analysis (see Chapter 4). A more rigorous investigation, such as a risk analysis may be needed for large culvert installations or when deviations from recommended design frequencies are indicated. Refer to Chapter 3 for discussion design by Evaluation of Risk assessment.

Site Data

The survey should provide you with sufficient data for locating the culvert and identifying information on all features affected by installation of the culvert, such as elevations and locations of houses, commercial buildings, croplands, roadways, and utilities. See Chapter 3 Process and Procedures and Chapter 4 Hydrology.

Culvert Location

Culvert location involves the horizontal and vertical alignment of the culvert with respect to both the stream and the highway. The culvert location affects hydraulic performance of the culvert, stream and embankment stability, construction and maintenance costs, and safety and integrity of the highway.

Ideally, you place a culvert in the natural channel (see Figure 8-1). This location usually provides good alignment of the natural flow with the culvert entrance and outlet. It usually requires little structural excavation or channel work, which requires a USACE permit.

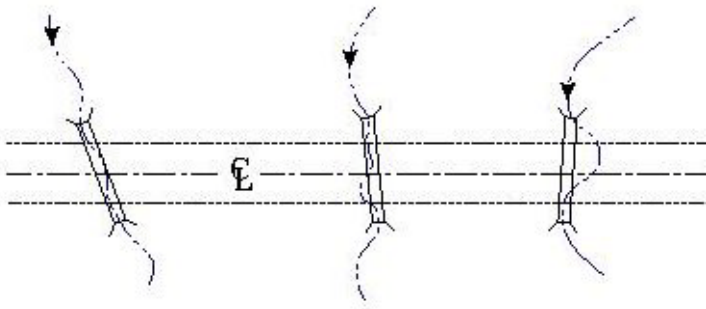

Figure 8-1. Culvert Placement Locations

Establishing the culvert's vertical orientation is usually a matter of placing the upstream flow line and downstream flow line elevations of the culvert at the same elevations as the existing streambed.

In some instances, the upstream flowline may need to be lowered or raised. Lowering the upstream flowline can provide an improved hydraulic operation but may create maintenance problems due to a higher potential for both sedimentation and scour. However, lowering the upstream flowline can also decrease the slope of the culvert, thereby slowing the velocity and decreasing the potential for downstream scour.

The placement of the downstream flowline of the culvert at a level higher than the roadway embankment toe of slope should be avoided. Such a configuration results in a waterfall that increases the potential for erosion.

Sometimes, extending a culvert to accommodate a widened roadway requires changing the flowline slope at one or both ends. Such a configuration is called a broken back culvert. In some cases, a broken back configuration can be designed to reduce the outlet velocity by introducing a hydraulic jump inside the culvert.

Waterway Considerations

The installation of a culvert through a highway embankment may significantly constrict the floodplain. Therefore, pre-construction data should be collected to predict the consequences of the culvert alteration. Refer to Chapters 4, 5, and 7 for information on site surveys and data collection, hydrology, NFIP criterion, and channel properties.

The longitudinal slope of the existing channel in the vicinity of the proposed culvert should be determined in order to establish culvert vertical profile and to define flow characteristics in the natural stream. Often, the proposed culvert can be positioned at the same longitudinal slope as the streambed.

The existing channel must be evaluated for downstream obstructions that will affect the tailwater. Obstructions may include a narrowing of the channel or another roadway crossing or railroad crossing. Other phenomena which may affect the tailwater may be represented by a high roughness coefficient such as vegetation or excessive sinuosity, usually expressed as Mannings "n" (See Chapter 6, Roughness Coefficients). Other sources may include a decreasing channel slope, or water backed up from another source. The tailwater elevation will affect culvert capacity under outlet control conditions or may even drive a culvert into outlet control which may otherwise operate as inlet control.

The storage capacity upstream of (behind) the culvert may need to be considered, especially if the culvert is to be altered in a way that may increase the headwater.

The channel must be scrutinized downstream for adequate capacity, especially if a culvert will be replaced with a larger barrel. Increased flow through the larger barrel could be perceived as causing flooding that had not occurred before. Although rare, the situation has been known to occur.

Roadway Data

The proposed or existing roadway affects culvert cost, hydraulic efficiency, and alignment.

Information from the roadway profile and the roadway cross section should be obtained from preliminary roadway drawings or from standard details on roadway sections. If the culvert must be sized prior to the development of preliminary plans, a best estimate of the roadway section must be developed, and the culvert design must be confirmed after the roadway plans are completed.

Roadway cross sections normal to the centerline are typically available from highway plans. However, the required cross section at the stream crossing may be skewed with reference to the roadway centerline. To obtain this section for a proposed culvert, combine roadway plan, profile, and cross-sectional data as necessary.

Preliminary dimensions and features of the culvert should become evident when the desired roadway cross section has been evaluated or established. The dimensions may be obtained by

superimposing the estimated culvert barrel on the roadway cross section and the streambed profile, which will establish the inlet and outlet invert elevations. The elevations and the resulting culvert length are approximate since the final culvert barrel size must still be determined.

The roadway embankment represents an obstruction to the flowing stream, much like a dam. The culvert is similar to the normal release structure, and the roadway crest acts as an emergency spillway in the event that the upstream pool (headwater) attains a sufficient elevation. The location of initial overtopping depends on the roadway geometry. Generally, the location of overtopping (roadway sag) should coincide as closely as possible to the location of the majority of flood flow under existing conditions. Since the roadway centerline profile may not represent the high point in the highway cross section, location of the actual low point is critical.

Allowable Headwater

Energy is required to force flow through a culvert. Energy takes the form of an increased water surface elevation on the upstream side of the culvert. The depth of the upstream water surface measured from the invert at the culvert entrance is generally referred to as headwater depth.

The headwater subtended by a culvert is a function of several parameters, including the culvert geometric configuration. The culvert geometric configuration elevation consists of the number of barrels, barrel dimensions, length, slope, entrance characteristics, and barrel roughness characteristics.

Selection of a design flood and allowable design headwater elevation are restricted by the potential for on damage to adjacent property, damage to the culvert and the roadway, traffic interruption, hazard to human life, and damage to stream and floodplain environment. Potential damage to adjacent property or inconvenience to owners should be of primary concern in the design of all culverts. By definition, the allowable headwater associated with the design discharge must also be below the roadway, that is, the roadway must be passable. Other possible critical elevations on the highway itself include edge of pavement, sub-grade crown, and top of headwall. In addition, the allowable headwater of the 1% AEP should be limited to 1.0 foot if at all practicable. For roadways encroaching on a FEMA-designated floodplain or Special Flood Hazard Area, refer to Chapter 5 for information on FEMA NFIP criteria and procedures.

Culvert installations under high fills may present an opportunity to use a high headwater or [ponding](#) to attenuate flood peaks. The possibility of catastrophic failure should be investigated prior to considering deep ponding because a breach in the highway fill could be quite similar to a dam failure:

Culverts should be located and designed for the least disruption of the existing flow distribution. Culvert headwater study should include verification that watershed divides are higher than design headwater elevations. If the divides are not sufficiently high to contain the headwater, if at all possible, culverts of lesser depths or earthen training dikes should be used to avoid diversion across watershed divides. In flat terrain, watershed divides are often undefined or nonexistent.

Outlet Velocity

The two basic culvert design criteria are allowable headwater and allowable velocity. Similar to the allowable headwater, the allowable outlet velocity is a design criterion that is unique to each culvert site. Allowable headwater usually governs the overall configuration of the culvert. However, the allowable outlet velocity only partially governs the overall culvert configuration but is the governing criterion in the selection and application of various downstream fixtures and appurtenances.

The velocity in the culvert is likely to be higher than that in the channel because the culvert usually constricts the available channel area. This increased velocity can cause streambed scour and bank erosion in the vicinity of the culvert outlet. There may also be eddies resulting from flow expansion. It is important to control the amount of scour at the culvert outlet because of the possibility of undermining of the headwall and loss of support of the culvert itself. Bank erosion may threaten nearby structures and may also disrupt the stability of the channel itself.

Scour prediction is somewhat subjective because the velocity at which erosion will occur is dependent upon many variables such as the characteristics of the bed and bank material, depth of flow in the channel and at the culvert outlet, velocity, velocity distribution, and the amount of sediment and other debris in the flow. Scour developed at the outlet of similar existing culverts in the vicinity is always a good guide in estimating potential scour at the outlet of proposed culverts.

Scour does not develop at all suspected locations because the susceptibility of the stream to scour is difficult to assess and the flow conditions that will cause scour do not occur at all flow rates. At locations where scour is expected to develop only during relatively rare flood events, the most economical solution may be to repair damage after it occurs.

At many locations, use of a simple outlet treatment (e.g., cutoff walls, aprons of concrete or riprap) will provide adequate protection against scour. At other locations, adjustment of the barrel slope may be sufficient to prevent damage from scour.

When the outlet velocity will greatly exceed the erosive velocity in the downstream channel, considerations should be given to energy dissipation devices (e.g., stilling basins, riprap basins). It should be recognized, however, that such structures are costly, many do not provide protection over a wide range of flow rates, some require a high tailwater to perform their intended function, and the outlet velocity of most culverts is not high enough to form a hydraulic jump that is efficient in dissipating energy. Therefore, selection and design of an energy dissipation device to meet the needs at a particular site requires a thorough study of expected outlet flow conditions and the performance of various devices. The cost of dissipation devices may dictate the design that provides outlet protection from low-frequency (high AEP) discharges and accepts the damage caused by larger floods. See Section 5 Velocity Protection and Control Devices.

Velocities of less than about 2 fps (0.5 m per second) usually foster deposition of sediments. Therefore, 2fps (0.5 m per second) is recommended as a minimum for culvert design and operation.

End Treatments

End treatments serve several different purposes but typically act as a retaining wall to keep the roadway embankment material out of the culvert opening. Secondary characteristics of end treatments include hydraulic improvements, traffic safety, debris interception, flood protection, and prevention of piping (flow through the embankment outside of the culvert).

Traffic Safety

Cross-drainage and longitudinal drainage facilities are usually necessary in any highway project to relieve drainage from the natural phenomenon of runoff to the highway. However, due to their inherent mass and fixed nature, they can pose somewhat of a safety threat to errant vehicles and associated drivers and passengers.

Figure 8-2 shows sketches of various end treatment types. The Bridge Division maintains standard details of culvert end treatments. For requirements and applications, see the Roadway Design Manual.

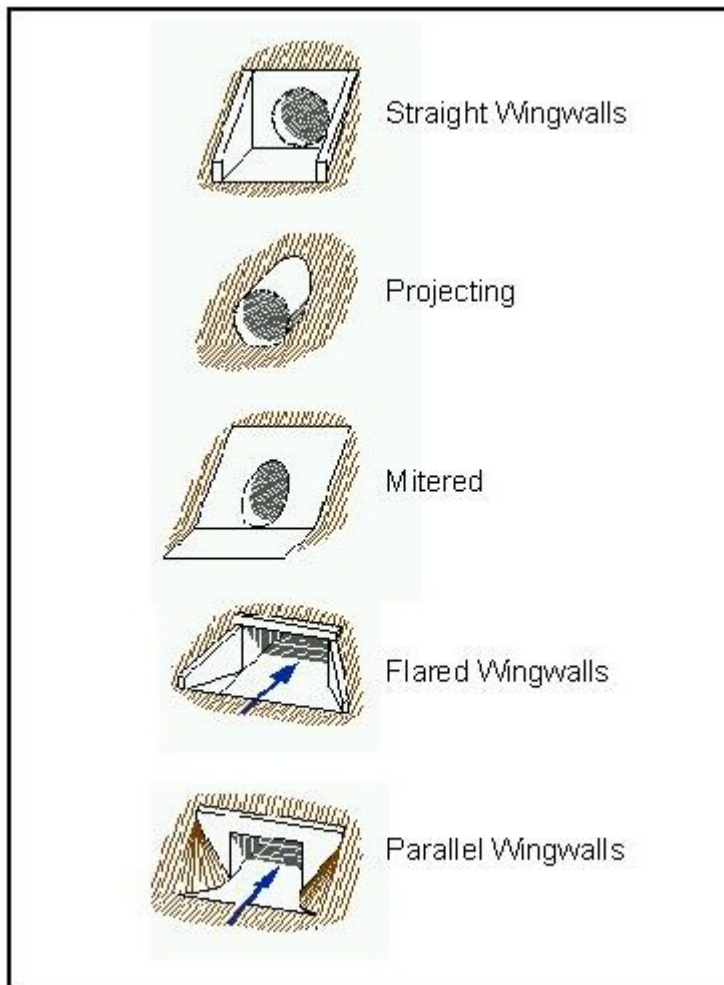

Figure 8-2. Typical Culvert End Treatments

Safety end treatment (SET) of a culvert provides a method of mitigating a less safe condition without interfering with the hydraulic function of the culvert. SETs such as those used with driveway and other small diameter culverts may be more hydraulically efficient by providing both tapered wingwalls and a beveled edge instead of using a mitered section. SETs for larger culverts that are not protected by a railing or guard fence use pipe runners arranged either horizontally or vertically.



Figure 8-3. Pipe mitered to conform to fill slope.



Figure 8-4. Pipe mitered to conform to fill slope.



Figure 8-5. End section conforming to fill slope



Figure 8-6. End section conforming to fill slope with pipe runners

Shielding by metal beam guard fence is a traditional protection method and has proven to be very effective in terms of safety. However, metal beam guard fence also can be more expensive than safety end treatment.

Generally, if clear zone requirements can be met, neither safety end treatment nor protection such as guard fence is necessary. However, some site conditions may still warrant such measures. See the Design Clear Zone Requirements in the [Roadway Design Manual](#) for more information.

Culvert Selection

Total culvert cost can vary considerably depending upon the culvert type. Generally, the primary factors affecting culvert type selection in Texas are economics, hydraulic properties, durability, and strength.

The following factors influence culvert type selection:

- ◆ fill height
- ◆ terrain
- ◆ foundation condition
- ◆ shape of the existing channel
- ◆ roadway profile
- ◆ allowable headwater
- ◆ stream stage discharge
- ◆ frequency-discharge relationships
- ◆ cost
- ◆ service life

- ◆ fish passage.

Culvert type selection includes the choice of materials to meet design life, culvert shapes, and number of culvert barrels. First, select a material that satisfies hydraulic and structural requirements at the lowest cost. Keep in mind that material availability and ease of construction both influence the total cost of the structure.

Second, choose culvert components that are readily available to construction contractors. Such material choices usually will assure better bid prices for the project.

Some commonly used combinations are as follows:

- ◆ Pipe (concrete, steel, aluminum, plastic): circular or pipe-arch and elliptical (CMP only).
- ◆ Structural-plate (steel or aluminum): circular, pipe-arch, elliptical, or arch.
- ◆ Box (or rectangular) (single or multiple barrel boxes or multiple boxes): concrete box culvert or steel or aluminum box culvert.
- ◆ Long span (structural-plate, steel or aluminum): low-profile arch, high profile arch, elliptical, or pear.

Culvert Shapes

Typically, several shapes provide hydraulically adequate design alternatives:

- ◆ Circular -- The most common shape used for culverts, this shape is available in various strengths and sizes. The need for cast-in-place construction is generally limited to culvert end treatments and appurtenances.
- ◆ Pipe-arch and elliptical – Generally used in lieu of circular pipe where there is limited cover or overfill, structural strength characteristics usually limit the height of fill over these shapes when the major axis of the elliptical shape is laid in the horizontal plane. These shapes are typically more expensive than circular shapes for equal hydraulic capacity.
- ◆ Box (or rectangular) -- A rectangular culvert lends itself more readily than other shapes to low allowable headwater situations. The height may be lowered and the span increased to satisfy hydraulic capacity with a low headwater. In addition, multiple barrel box culverts accommodate large flow rates with a low profile.
- ◆ Modified box -- Economical under certain construction situations, the longer construction time required for cast-in-place boxes can be an important consideration in the selection of this type of culvert. Pre-cast concrete and metal box sections have been used to overcome this disadvantage.
- ◆ Arch -- Arch culverts span a stream using the natural streambed as the bottom. As a result arch culverts serve well in situations where the designer wishes to maintain the natural stream bottom for reasons such as fish passage. Nevertheless, the scour potential and the structural

stability of the streambed must be carefully evaluated. Structural plate metal arches are limited to use in low cover situations.

The terrain often dictates the need for a low profile due to limited fill height or potential debris clogging.

Multiple Barrel Boxes

Culverts consisting of more than one box are useful in wide channels where the constriction or concentration of flow must be kept to a minimum. Alternatively, low roadway embankments offering limited cover may require a series of small openings. In addition, the situation may require separating the boxes to maintain flood flow distribution. As a general recommendation, where a culvert consists of more than one barrel, shapes of uniform geometry and roughness characteristics should be used to maintain uniform flow distribution. Locations where debris flow may obstruct the culvert entrance may be better served with a clear span bridge.

Certain situations warrant placing boxes at various elevations. Placing one box at the natural stream flowline and placing additional boxes slightly higher is good practice for the following reasons:

- ◆ the configuration does not require widening the natural channel
- ◆ the side boxes provide overflow (flood) relief when needed but do not silt up or collect debris when dry
- ◆ the minimal stream modification supports environmental preservation.

Design versus Analysis

Culvert design is an iterative process that starts with reasonable assumptions and culminates with a final selection of material, shape, and placement that satisfies the requirements of function and safety. Culvert analysis is a straight forward process that determines the functioning status of an existing culvert structure or a proposed design.

Culvert analysis includes determination of flow rates, velocities, and water surface elevations for the full range of probabilities (50%, 20%, 10%, 4%, 2%, and 1% AEPs) for both the existing and the proposed conditions. A complete list of the requirements for design can be found in the [Documentation Reference Tables](#) in Chapter 3.

Differences exist between computer programs. Simple culvert computer programs have limitations such as how they handle roadway overtopping and upstream momentum. More complex hydraulic programs are not so limited because they include features such as backwater calculations and more data input capabilities. Unless the culvert is hydraulically simple, the more complex hydraulic programs are recommended for use. For situations where the roadway is overtopped at the structure, the simplified computer methods become unstable when overtopping occurs. These errors can be critical when a FEMA NFIP analysis of water surface elevation is required. (See Chapter 5, [Fed-](#)

[eral Emergency Management Agency \(FEMA\) National Flood Insurance Program \(NFIP\) Compliant Design Of Floodplain Encroachments And Minor Structures.](#))

Culvert Design Process

The culvert design process includes the following basic stages:

1. Define the location, FEMA NFIP status, orientation, shape, and material for the culvert to be designed. In many instances, consider more than a single shape and material.
2. With consideration of the site data, establish allowable outlet velocity (v_{\max}) and maximum allowable depth of barrel.
3. Based upon subject discharges (Q), associated tailwater levels (TW), and allowable headwater level (HW_{\max}), select an overall culvert configuration -- culvert hydraulic length (L), entrance conditions, and conduit shape and material to be analyzed.
4. Determine the flow type (supercritical or subcritical) to establish the proper approach for determination of headwater and outlet velocity.
5. Determine the headwater elevation and outlet velocity.
6. Adjust slope or shape for excessive outlet velocity if necessary. Check effect on headwater elevation.
7. Continue to adjust configuration until headwater elevation and outlet velocity are within allowable limits. It may be necessary to treat any excessive outlet velocity separately from headwater and control by other means such as velocity controls.

Design Guidelines and Procedure for Culverts

The flow charts of Figure 8-7 and Figure 8-8 can guide the hydraulic designer in computing for the vast majority of culvert design situations.

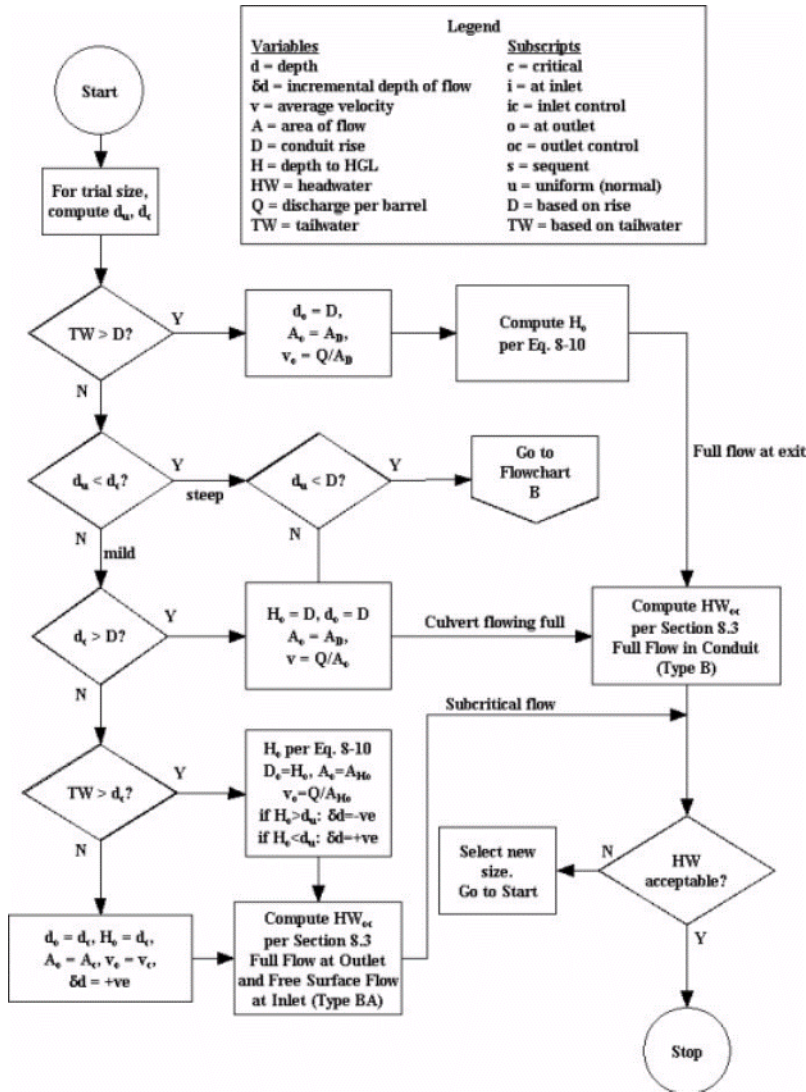

Figure 8-7. Flow Chart A - Culvert Design Procedure

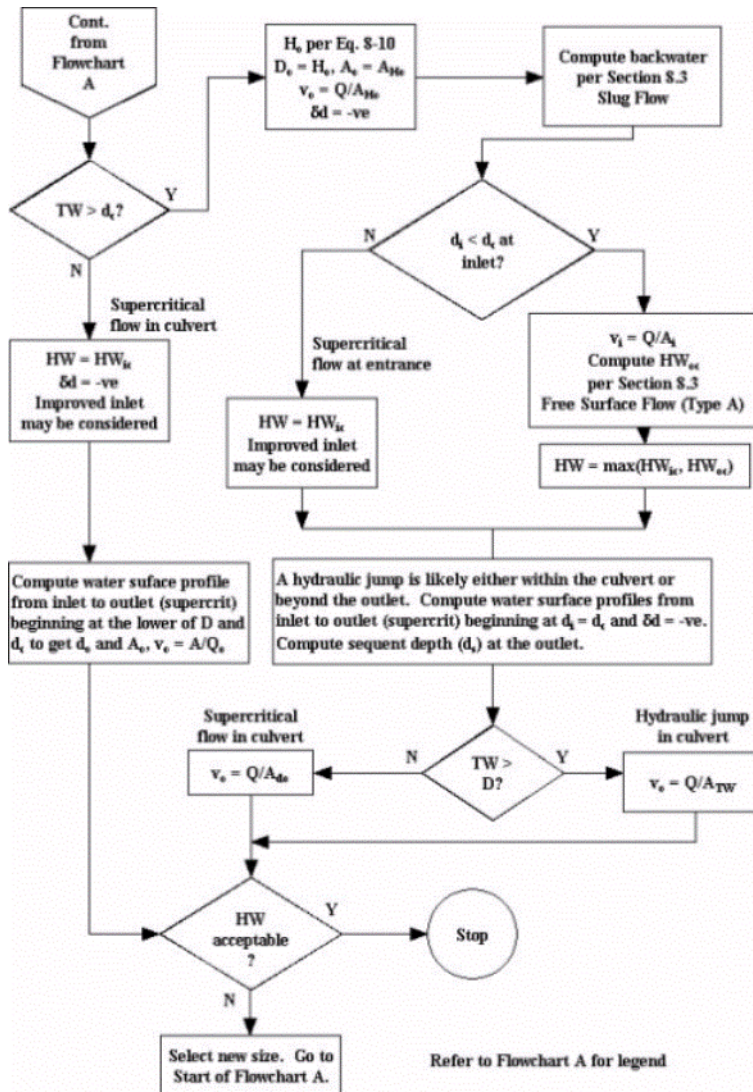

Figure 8-8. Flow Chart B - Culvert Design Procedure (cont.)

The following is a step-by-step culvert design procedure for a standard culvert configuration, i.e. straight in profile with one or more barrels of equal size. Each of the configurations considered in the iterative process of design process influences a unique flow type. Each new iteration requires a determination of whether there is inlet or outlet control.

1. Establish an initial trial size. The trial size may be picked at random or judiciously, based on experience. However, one convenient rule-of-thumb is to assume inlet control and proceed as follows: Determine the maximum practical rise of culvert (D_{max}) and the maximum allowable headwater depth (HW_{max}). Determine a trial head using Equation 8-1.

$$h = HW_{max} - \frac{D_{max}}{2}$$

Equation 8-1.

where:

h = allowable effective head (ft. or m)

HW_{\max} = allowable headwater depth (ft. or m)

D_{\max} = maximum conduit rise (ft. or m).

Use Equation 8-2 (a form of the orifice equation) to determine the required area, A , for the design discharge, Q . This assumes an orifice coefficient of 0.5, which is reasonable for initial estimates only.

$$A = 0.45 \frac{Q}{h^{0.5}}$$

Equation 8-2.

where:

A = approximate cross-sectional area required (sq.ft. or m^2)

Q = design discharge (cfs or m^3/s).

Decide on the culvert shape:

- ◆ A properly designed culvert has an effective flow area similar in height and width to the approach channel section so that approach velocities and through-culvert velocities are similar.
- ◆ For a box culvert, determine the required width, W , as A/D_{\max} . Round W to the nearest value that yields a whole multiple of standard box widths. Divide W by the largest standard span S for which W is a multiple. This yields the number of barrels, N . At this point, the determination has been made that the initial trial configuration will be $N - S D_{\max} L$, where L is the length of the barrel in feet.
- ◆ For a circular pipe culvert, determine the ratio of area required to maximum barrel area according to Equation 8-3.

$$\frac{4A}{\pi D_{\max}^2} \leq N$$

Equation 8-3.

- ◆ Round this value to the nearest whole number to get the required number of barrels, N . At this point, the determination has been made that the initial trial size culvert will be $N - D L$ circular pipe.
- ◆ For other shapes, provide an appropriate size such that the cross section area is approximately equal to A .

2. Determine the design discharge per barrel as Q/N . This assumes that all barrels are of equal size and parallel profiles with the same invert elevations. The computations progress using one barrel with the appropriate apportionment of flow.

3. Perform a hydraulic analysis of the trial configuration. Generally, a computer program or spreadsheet would be used. Nomographs and simplified hand methods should be used only for preliminary estimates. For the trial configuration determine the inlet control headwater (HW_{ic}), the outlet control headwater (HW_{oc}) and outlet velocity (v_o) using Flow Chart A shown in Figure 8-7. Flow Chart A references Flow Chart B, which is shown in Figure 8-8.
4. Evaluate the trial design. At this step in the design process, you have calculated a headwater and outlet velocity for the design discharge through a trial culvert configuration has been calculated.
 - ◆ If the calculated headwater is equal to or is not appreciably lower than the allowable headwater (an indication of culvert efficiency), the design is complete. A good measure of efficiency is to compare the calculated headwater with the culvert depth D . If the headwater is less than the depth, the configuration may not be efficient.
 - ◆ If the calculated headwater is considerably lower than the allowable headwater or lower than the culvert depth D , a more economical configuration may be possible. Choose the trial culvert configuration by reducing the number of barrels, span widths, diameter, or other geometric or material changes. Repeat the calculations from step 2.
 - ◆ If the calculated headwater is equal to or is not appreciably lower than the actual headwater and the culvert is operating as inlet control, an improved inlet may be in order.
 - ◆ If the calculated headwater is greater than the actual headwater, change the trial culvert configuration to increase capacity by adding barrels, widening spans, and increasing diameter. Repeat the calculations from step 2.
 - ◆ If the operation is not inlet control, then the culvert geometry design is complete.
 - ◆ If the culvert is operating with inlet control, the possibility exists for improving the entrance conditions with the aim of reducing the overall cost of the structure. Investigate the design of a flared (or tapered) inlet and associated structure. Because of the cost of the improved inlet, make a careful economic comparison between the design with a normal entrance and the design with an improved inlet.
 - ◆ Check outlet velocities against the predetermined maximum allowable for the site. The culvert for which the calculated headwater is satisfactory may have an excessive outlet velocity. Excessive velocities are usually caused by a steep slope or a computational error. The definition of "excessive" is usually an engineering judgment based on local and soil conditions, but as a general rule, anything over 12 fps is considered excessive.

Consider any required outlet control or protection device as part of the hydraulic design. It is normal for a properly designed culvert to have an outlet velocity that is greater than the natural stream velocity.

1. Develop a hydraulic performance curve using the procedures outlined in the [Hydraulic Operation of Culverts](#) section. An overall hydraulic performance curve for the designed culvert indicates headwater and outlet velocity characteristics for the entire range of discharges. At an

absolute minimum, the additional analysis of the 1% AEP discharge is required for both the existing and the proposed conditions.

- The design can be completed if the results of the headwater and outlet velocity represent an acceptable risk and conform to FEMA NFIP requirements. (See Chapter 2 and pertinent parts of the [Project Development Policy Manual](#) for more details.)
- However, if any of the hydraulic characteristics are unacceptable, some adjustment to the culvert design may be in order.

Evaluate other culvert performance risks. Identify and evaluate the potential for increased impact associated with different flood conditions.

Section 3 — Hydraulic Operation of Culverts

Parameters

The hydraulic operation and performance of a culvert involve a number of factors. You must determine, estimate, or calculate each factor as part of the hydraulic design or analysis.

The following procedures assume steady flow but can involve extensive calculations that lend themselves to computer application. The procedures supersede simplified hand methods of other manuals. TxDOT recommends computer models for all final design applications, although hand methods and nomographs may be used for initial planning.

Headwater under Inlet Control

Inlet control occurs when the culvert barrel is capable of conveying more flow than the inlet will accept. Inlet control is possible when the culvert slope is hydraulically steep ($d_c > d_u$). The control section of a culvert operating under inlet control is located just inside the entrance. When the flow in the barrel is free surface flow, critical depth occurs at or near this location, and the flow regime immediately downstream is supercritical. Depending on conditions downstream of the culvert inlet, a hydraulic jump may occur in the culvert. Under inlet control, hydraulic characteristics downstream of the inlet control section do not affect the culvert capacity. Upstream water surface elevation and inlet geometry (barrel shape, cross-sectional area, and inlet edge) are the major flow controls.

A fifth-degree polynomial equation based on regression analysis is used to model the inlet control headwater for a given flow. Analytical equations based on minimum energy principles are matched to the regression equations to model flows that create inlet control heads outside of the regression data range. Equation 8-4 only applies when $0.5 \leq HW_{ic}/D \leq 3.0$.

$$HW_x = [a + bF + cF^2 + dF^3 + eF^4 + fF^5]D - 0.5DS_0$$

Equation 8-4.

where:

HW_{ic} = inlet control headwater (ft. or m)

D = rise of the culvert barrel (ft. or m)

a to f = regression coefficients for each type of culvert (see the following [table](#))

S_0 = culvert slope (ft./ft. or m/m)

F = function of average outflow discharge routed through a culvert; culvert barrel rise; and for box and pipe-arch culverts, width of the barrel, B , shown in Equation 8-5.

$$F = 18113 \frac{Q}{WD^{3/2}}$$

Equation 8-5.

where:

W = width or span of culvert (ft. or m).

Table 8-1: Regression Coefficients for Inlet Control Equations

Shape and Material	Entrance Type	a	b	c	d	e	f
RCP	Square edge w/headwall	0.087483	0.706578	-0.2533	0.0667	-0.00662	0.000251
-	Groove end w/headwall	0.114099	0.653562	-0.2336	0.059772	-0.00616	0.000243
-	Groove end projecting	0.108786	0.662381	-0.2338	0.057959	-0.00558	0.000205
-	Beveled ring	0.063343	0.766512	-0.316097	0.08767	-0.00984	0.000417
-	Improved (flared) inlet	0.2115	0.3927	-0.0414	0.0042	-0.0003	-0.00003
CMP	Headwall	0.167433	0.53859	-0.14937	0.039154	-0.00344	0.000116
-	Mitered	0.107137	0.757789	-0.3615	0.123393	-0.01606	0.000767
-	Projecting	0.187321	0.567719	-0.15654	0.044505	-0.00344	0.00009
-	Improved (flared) inlet	0.2252	0.3471	-0.0252	0.0011	-0.0005	-0.00003
Box	30-70° flared wingwall	0.072493	0.507087	-0.11747	0.02217	-0.00149	0.000038
-	Parallel to 15° wingwall	0.122117	0.505435	-0.10856	0.020781	-0.00137	0.0000346
-	Straight wingwall	0.144138	0.461363	-0.09215	0.020003	-0.00136	0.000036
-	45° wingwall w/top bevel	0.156609	0.398935	-0.06404	0.011201	-0.00064	0.000015
-	Parallel headwall w/ bevel	0.156609	0.398935	-0.06404	0.011201	-0.00064	0.000015
-	30° skew w/chamfer edges	0.122117	0.505435	-0.10856	0.020781	-0.00137	0.000034
-	10-45° skew w/bevel edges	0.089963	0.441247	-0.07435	0.012732	-0.00076	0.000018
Oval B>D	Square edge w/headwall	0.13432	0.55951	-0.1578	0.03967	-0.0034	0.00011
-	Groove end w/headwall	0.15067	0.50311	-0.12068	0.02566	-0.00189	0.00005
-	Groove end projecting	-0.03817	0.84684	-0.32139	0.0755	-0.00729	0.00027

Table 8-1: Regression Coefficients for Inlet Control Equations

Shape and Material	Entrance Type	a	b	c	d	e	f
Oval D>B	Square edge w/headwall	0.13432	0.55951	-0.1578	0.03967	-0.0034	0.00011
-	Groove end w/headwall	0.15067	0.50311	-0.12068	0.02566	-0.00189	0.00005
-	Groove end projecting	-0.03817	0.84684	-0.32139	0.0755	-0.00729	0.00027
CM Pipe arch	Headwall	0.111261	0.610579	-0.194937	0.051289	-0.00481	0.000169
-	Mitered	0.083301	0.795145	-0.43408	0.163774	-0.02491	0.001411
-	Projecting	0.089053	0.712545	-0.27092	0.792502	-0.00798	0.000293
Struct plate Pipe arch	Projecting—corner plate (17.7 in. or 450 mm)	0.089053	0.712545	-0.27092	0.792502	-0.00798	0.000293
-	Projecting—corner plate (30.7 in. or 780 mm)	0.12263	0.4825	-0.00002	-0.04287	0.01454	-0.00117
CM arch (flat bottom)	Parallel headwall	0.111281	0.610579	-0.1949	0.051289	-0.00481	0.000169
-	Mitered	0.083301	0.795145	-0.43408	0.163774	-0.02491	0.001411
-	Thin wall projecting	0.089053	0.712545	-0.27092	0.792502	-0.00798	0.000293

For $HW_i/D > 3.0$, Equation 8-6, an orifice equation, is used to estimate headwater:

- ◆ Determine the potential head from the centroid of the culvert opening, which is approximated as the sum of the invert elevation and one half the rise of the culvert. The effective area, A , and orifice coefficient, C , are implicit.
- ◆ Determine the coefficient, k , by rearranging Equation 8-6 using the discharge that creates a HW/D ratio of 3 in the regression equation, Equation 8-7 (i.e., the upper limit of the [Equation 8-1](#)):

$$HW_i = \left[\frac{Q}{k} \right]^2 + \frac{D}{2}$$

Equation 8-6.

where:

HW_i = inlet control headwater depth (ft. or m)

Q = design discharge (cfs or m^3/s)

k = orifice equation constant

D = rise of culvert (ft. or m).

$$k = 0.6325 \frac{Q_{3.0}}{D^{1.2}}$$

Equation 8-7.

where:

$Q_{3.0}$ = discharge (cfs or m³/s) at which HW/D = 3.

Generally for TxDOT designs, it is not considered efficient to design culverts for $HW_i/D < 0.5$. However, if such a condition is likely, an open channel flow minimum energy equation (weir equation) should be used, with the addition of a velocity head loss coefficient. The minimum energy equation, with the velocity head loss adjusted by an entrance loss coefficient, generally describes the low flow portion of the inlet control headwater curve. However, numerical errors in the calculation of flow for very small depths tend to increase the velocity head as the flow approaches zero. This presents little or no problem in most single system cases because the flows that cause this are relatively small.

In many of the required calculations for the solution of multiple culverts, the inlet control curve must decrease continuously to zero for the iterative calculations to converge. Therefore, computer models modify this equation to force the velocity head to continually decrease to zero as the flow approaches zero.

The “Charts” in [HDS-5](#) (FHWA, Hydraulic Design of Highway Culverts) provide guidance for graphical solution of headwater under inlet control.

Headwater under Outlet Control

Outlet control occurs when the culvert barrel is not capable of conveying as much flow as the inlet opening will accept. Outlet control is likely only when the hydraulic grade line inside the culvert at the entrance exceeds critical depth. (See Chapter 6 for Hydraulic Grade Line Analysis.) Therefore, outlet control is most likely when the culvert is on a mild slope ($d_n > d_c$). It is also possible to experience outlet control with a culvert on a steep slope ($d_n < d_c$) with a high tailwater such that subcritical flow or full flow exists in the culvert.

The headwater of a culvert in outlet control is a function of discharge, conduit section geometry, conduit roughness characteristics, length of the conduit, profile of the conduit, entrance geometry (to a minor extent), and (possibly) tailwater level.

The headwater of a culvert under outlet control can be adjusted, for practical purposes, by modifying culvert size, shape, and roughness. Both inlet control and outlet control need to be considered to determine the headwater. The following table provides a summary conditions likely to control the

culvert headwater. Refer to Figure 8-4 and Figure 8-5 to identify the appropriate procedures to make the determination.

Table 8-2: Conditions Likely to Control Culvert Headwater

Description	Likely Condition
Hydraulically steep slope, backwater does not submerge critical depth at inside of inlet	Inlet control
Hydraulically steep slope, backwater submerges critical depth at inside of inlet	Outlet control
Hydraulically steep slope, backwater close to critical depth at inlet	Oscillate between inlet and outlet control.
Hydraulically mild slope	Outlet control

Outlet control headwater is determined by accounting for the total energy losses that occur from the culvert outlet to the culvert inlet. Figure 8-7 and Figure 8-8 and associated procedures in Section 4 should be used to analyze or design a culvert.

Outlet control headwater HW_{oc} depth (measured from the flowline of the entrance) is expressed in terms of balancing energy between the culvert exit and the culvert entrance as indicated by Equation 8-8.

$$HW_{oc} + h_{v_e} = h_e + h_{v_i} + \sum h_f - S_o L + H_o$$

Equation 8-8.

where:

HW_{oc} = headwater depth due to outlet control (ft. or m)

h_{v_a} = velocity head of flow approaching the culvert entrance (ft. or m)

h_{v_i} = velocity head in the entrance (ft. or m) as calculated using Equation 8-9.

h_e = entrance head loss (ft. or m) as calculated using [Equation 8-16](#)

h_f = friction head losses (ft. or m) as calculated using [Equation 8-11](#)

S_o = culvert slope (ft./ft. or m/m)

L = culvert length (ft. or m)

H_o = depth of hydraulic grade line just inside the culvert at outlet (ft. or m) (outlet depth).

$$h_v = \left[\frac{v^2}{2g} \right]$$

Equation 8-9.

where:

v = flow velocity in culvert (ft./s or m/s).

g = the gravitational acceleration = 32.2 ft/ s² or 9.81 m/s².

For convenience energy balance at outlet, energy losses through barrel, and energy balance at inlet should be considered when determining outlet control headwater.

When the tailwater controls the outlet flow, Equation 8-10 represents the energy balance equation at the conduit outlet. Traditional practice has been to ignore exit losses. If exit losses are ignored, the hydraulic grade line inside the conduit at the outlet, outlet depth, H_o , should be assumed to be the same as the hydraulic grade line outside the conduit at the outlet and Equation 8-10 should not be used.

$$H_o = TW + h_{TW} + h_o - h_{vo}$$

Equation 8-10.

where:

h_{vo} = velocity head inside culvert at outlet (ft. or m)

h_{TW} = velocity head in tailwater (ft. or m)

h_o = exit head loss (ft. or m).

The outlet depth, H_o , is the depth of the hydraulic grade line inside the culvert at the outlet end. The outlet depth is established based on the conditions shown below.

Table 8-3: Outlet Depth Conditions

If...	And...	Then...
Tailwater depth (TW) exceeds critical depth (d_c) in the culvert at outlet	Slope is hydraulically mild	Set H_o using Equation 8-10, using the tailwater as the basis.
Tailwater depth (TW) is lower than critical depth (d_c) in culvert at outlet	Slope is hydraulically mild	Set H_o as critical depth.
Uniform depth is higher than top of the barrel	Slope is hydraulically steep	Set H_o as the higher of the barrel depth (D) and depth using Equation 8-10.
Uniform depth is lower than top of barrel and tailwater exceeds critical depth	Slope is hydraulically steep	Set H_o using Equation 8-10.
Uniform depth is lower than top of barrel and tailwater is below critical depth	Slope is hydraulically steep	Ignore, as outlet control is not likely.

NOTE: For hand computations and some computer programs, H_o is assumed to be equal to the tailwater depth (TW). In such a case, computation of an exit head loss (h_o) would be meaningless since the energy grade line in the culvert at the outlet would always be the sum of the tailwater depth and the velocity head inside the culvert at the outlet (h_{vo}).

Energy Losses through Conduit

Department practice is to consider flow through the conduit occurring in one of four combinations:

- ◆ Free surface flow (Type A) through entire conduit.
- ◆ Full flow in conduit (Type B).
- ◆ Full flow at outlet and free surface flow at inlet (Type BA).
- ◆ Free surface at outlet and full flow at inlet (Type AB).

Free Surface Flow (Type A)

If free surface flow is occurring in the culvert, the hydraulic parameters are changing with flow depth along the length of the culvert as seen in Figure 8-9. It is necessary to calculate the backwater profile based on the outlet depth, H_o .

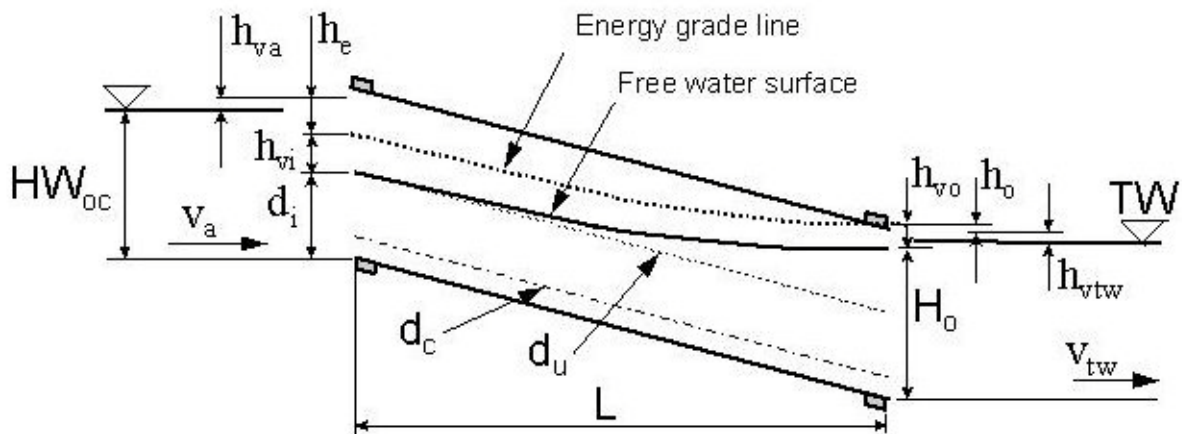

Figure 8-9. Outlet Control Headwater for Culvert with Free Surface

By definition, a free-surface backwater from the outlet end of a culvert may only affect the headwater when subcritical flow conditions exist in the culvert. Subcritical, free-surface flow at the outlet will exist if the culvert is on a mild slope with an outlet depth (H_o) lower than the outlet soffit or if the culvert is on a steep slope with a tailwater higher than critical depth at the culvert outlet and lower than the outlet soffit.

The [Direct Step Backwater Method](#) is used to determine the water surface profile (and energy losses) through the conduit. The depth, H_o , is used as the starting depth, d_1 . For subcritical flow, the calculations begin at the outlet and proceed in an upstream direction. Use the depth, H_o , as the starting depth, d_1 , in the Direct Step calculations.

When using the direct step method, if the inlet end of the conduit is reached without the calculated depth exceeding the barrel depth (D), it verifies that the entire length of the conduit is undergoing

free surface flow. Set the calculated depth (d_2) at the inlet as H_i and refer to Energy Balance at Inlet to determine the headwater.

When using the direct step method, if the calculated depth (d_2) reaches or exceeds the barrel depth (D), the inside of the inlet is submerged. Refer to Type AB - Free surface at outlet and full flow at inlet for a description. This condition is possible if the theoretical value of uniform depth is higher than the barrel depth.

Full Flow in Conduit (Type B)

If full flow is occurring in the conduit, rate of energy losses through the barrel is constant (for steady flow) as seen in Figure 8-10. The hydraulic grade line is calculated based on outlet depth, H_o , at the outlet.

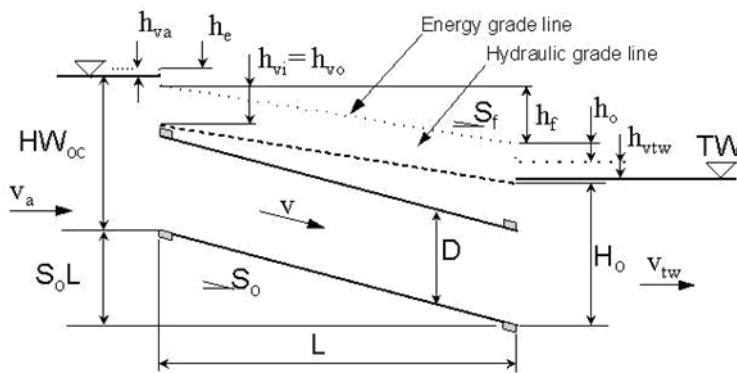

Figure 8-10. Outlet Control, Fully Submerged Flow

Full flow at the outlet occurs when the outlet depth (H_o) equals or exceeds barrel depth D . Full flow is maintained throughout the conduit if friction slope is steeper than conduit slope, or if friction slope is flatter than conduit slope but conduit is not long enough for the hydraulic grade line to get lower than the top of the barrel.

NOTE: Refer to Type BA – Submerged Exit, Free flow at Inlet to determine whether the entire conduit flows full.

Equation 8-11 determines the energy loss (friction loss) through the conduit:

$$h_f = S_f L$$

Equation 8-11.

where:

h_f = head loss due to friction in the culvert barrel (ft. or m)

S_f = friction slope (ft. or m) (See Equation 8-13.)

L = length of culvert containing full flow (ft. or m).

Equation 8-12 is used to compute the depth of the hydraulic grade line at the inside of the inlet end of the conduit. Refer to Energy Balance at Inlet to determine the headwater.

$$H_i = H_o + h_f - S_o L$$

Equation 8-12.

where:

H_i = depth of hydraulic grade line at inlet (ft. or m)

h_f = friction head losses (ft. or m) as calculated using Equation 8-11.

S_o = culvert slope (ft./ft. or m/m)

L = culvert length (ft. or m)

H_o = outlet depth (ft. or m).

Equation 8-13 is used to calculate friction slope. If friction slope is flatter than the conduit slope, the hydraulic grade line may drop below the top of the barrel. If this occurs, refer to Type BA - Full Flow at the outlet and free surface flow at the inlet.

$$S_f = \left(\frac{Qn}{zR^{2/3}A} \right)^2$$

Equation 8-13.

where:

S_f = friction slope (ft./ft. or m/m)

z = 1.486 for English measurements and 1.0 for metric.

Full Flow at Outlet and Free Surface Flow at Inlet (Type BA)

If the friction slope is flatter than the conduit slope, it is possible that full flow may not occur along the entire length of the culvert (see the Table 8-5 on [Entrance Loss Coefficients](#)). The following steps should be followed:

1. Determine the length over which full flow occurs (L_f) is using the geometric relationship shown in Equation 8-14 (refer to Table 8-5 on [Entrance Loss Coefficients](#)):

$$L_f = \frac{H_o - D}{S_o - S_f}$$

Equation 8-14.

where:

L_f = length over which full flow occurs (ft. or m)

- S_o = culvert slope (ft./ft. or m/m)
- S_f = friction slope (ft./ft. or m/m)
- H_o = outlet depth (ft. or m)
- D = Conduit barrel height (ft. or m).

Use the following table to determine how to proceed considering a conduit length L .

Table 8-4: Conduit Length (L) Procedure Determination

If...	Then proceed to...	Comment
If $S_f \geq S_o$	Type B energy loss calculations	Entire length of culvert is full
If $L_f \geq L$	Type B energy loss calculations	Entire length of culvert is full
If $L_f < L$	Step 2.	Outlet is full but free surface flow at inlet

2. Determine Type BA free surface losses, if applicable. Free surface flow begins at the point of intersection of the hydraulic grade line and the soffit of the culvert barrel as shown in Figure 8-11. If this condition occurs, determine the depth of flow at the inlet using the Direct Step Method with the starting depth (d_1) equal to the barrel rise (D) and starting at the location along the barrel at which free surface flow begins.
3. Determine Type BA hydraulic grade line at inlet, if applicable. When the inlet end of the conduit is reached using the direct step method, set the calculated depth at the inlet as H_i and refer to Energy Balance at Inlet to determine the headwater.

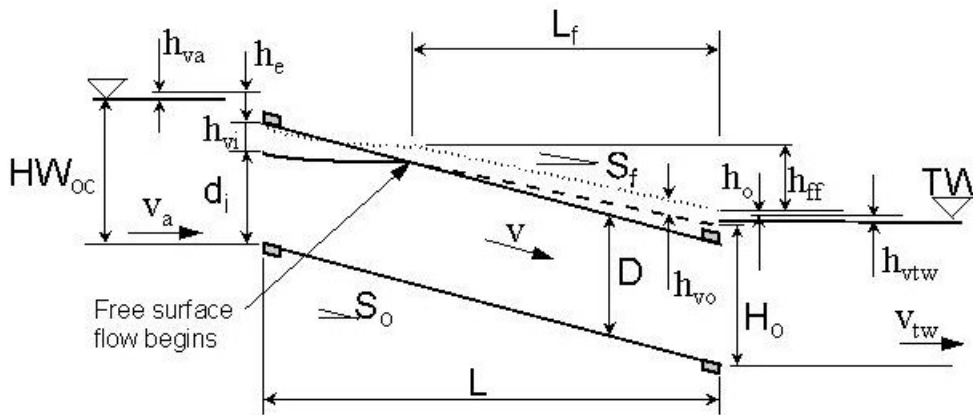

Figure 8-11. Point at Which Free Surface Flow Begins

Free Surface at Outlet and Full Flow at Inlet (Type AB)

When the outlet is not submerged, full flow will begin within the conduit if the culvert is long enough and the flow high enough. Figure 8-12 illustrates this condition. This condition is possible

if the theoretical value of uniform depth is higher than the barrel depth. The following steps should be followed:

1. Check Type AB uniform depth. Compare calculated uniform depth and the barrel depth, D . If the theoretical value of uniform depth is equal to or higher than the barrel depth, proceed to Free Surface Losses. Otherwise, refer to [Free Surface Flow \(Type A\)](#).
2. Determine Type AB free surface losses, if applicable. Refer to Water Surface Profile Calculations, Free Surface Flow to determine the water surface profile in the conduit. If the computed depth of flow reaches or exceeds the barrel depth before the end of the conduit, note the position along the conduit at which this occurs and proceed to full flow losses below. Otherwise, complete the procedure described under Free Surface Flow.
3. Determine Type AB full flow losses, if applicable. Begin full flow calculations at the point along the conduit where the computed water surface intersects the soffit of the barrel as determined above. Determine the energy losses through the remainder of the conduit using Equation 8-11 but substituting L_f , the remaining conduit length, for L .
4. Determine Type AB hydraulic grade line at inlet, if applicable. Compute the depth of the hydraulic grade line, H_i , at the inside of the inlet end of the conduit using Equation 8-12. Use the barrel height D as the starting hydraulic grade line depth in place of H_o , and use the remaining length, L_f , in place of L . Refer to Energy Balance at Inlet to determine headwater depth.

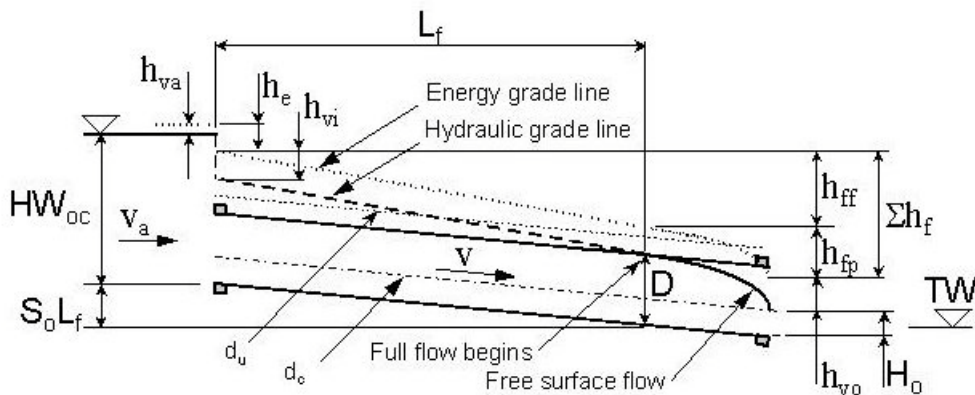

Figure 8-12. Headwater Due to Full Flow at Inlet and Free Surface at Outlet

Energy Balance at Inlet

The outlet control headwater, HW_{oc} , is computed by balancing the energy equation, depicted as Equation 8-15. The hydraulic grade at the inside face of the culvert at the entrance will need to be known. See [Energy Losses through Conduit](#). The velocity at the entrance (v_i) is used to compute the velocity head at the entrance (h_{vi}).

$$HW_{oc} = H_i + h_{vi} + h_e - h_{va}$$

Equation 8-15.

where:

HW_{oc} = headwater depth due to outlet control (ft. or m)

h_{va} = velocity head of flow approaching the culvert entrance (ft. or m)

h_{vi} = velocity head in the entrance (ft. or m) as calculated using Equation 8-9

h_e = entrance head loss (ft. or m) as calculated using Equation 8-16

H_i = depth of hydraulic grade line just inside the culvert at inlet (ft. or m).

Generally, when using Equation 8-15, the velocity approaching the entrance may be assumed to be negligible so that the headwater and energy grade line are coincident just upstream of the upstream face of the culvert. This is conservative for most department needs. The approach velocity may need to be considered when performing the following tasks:

- ◆ determining the impact of a culvert on FEMA designated floodplains
- ◆ designing or analyzing a culvert used as a flood attenuation device where the storage volumes are very sensitive to small changes in headwater.

The entrance loss, h_e , depends on the velocity of flow at the inlet, v_i , and the entrance configuration, which is accommodated using an entrance loss coefficient, C_e .

$$h_e = C_e \left[\frac{v_i^2}{2g} \right]$$

Equation 8-16.

where:

C_e = entrance loss coefficient

V_i = flow velocity inside culvert inlet (fps or m/s).

NOTE: The pipes of pipe runner SETs have been proven to be within the tolerance of the entrance loss equations. Therefore, the entrance should be evaluated solely for its shape and the effect of the pipes should be ignored.

Values of C_e are shown on the following table (Entrance Loss Coefficients) based on culvert shape and entrance condition. (AASHTO Highway Drainage Manual Guidelines, 4th Ed, Table 4-1)

Table 8-5: Entrance Loss Coefficients (C_e)

Concrete Pipe	C_e
Projecting from fill, socket end (groove end)	0.2

Table 8-5: Entrance Loss Coefficients (C_e)

Concrete Pipe	C_e
Projecting from fill, square cut end	0.5
Headwall or headwall and wingwalls:	-
◆ Socket end of pipe (groove end)	0.2
◆ Square-edge	0.5
◆ Rounded (radius 1/12 D)	0.2
Mitered to conform to fill slope	0.7
End section conforming to fill slope	0.5
Beveled edges, 33.7° or 45° bevels	0.2
Side- or slope-tapered inlet	0.2
Corrugated Metal Pipe or Pipe Arch	-
Projecting from fill (no headwall)	0.9
Headwall or headwall and wingwalls square-edge	0.5
Mitered to conform to fill slope, paved or unpaved slope	0.7
End section conforming to fill slope	0.5
Beveled edges, 33.7° or 45° bevels	0.2
Side- or slope-tapered inlet	0.2
Reinforced Concrete Box	-
Headwall parallel to embankment (no wingwalls):	-
◆ Square-edged on 3 edges	0.5
◆ Rounded on 3 edges to radius of 1/12 barrel dimension, or beveled edges on 3 sides	0.2
Wingwalls at 30° to 75° to barrel:	-
◆ Square-edged at crown	0.4
◆ Crown edge rounded to radius of 1/12 barrel dimension, or beveled top edge	0.2
Wingwall at 10° to 25° to barrel: square-edged at crown	0.5
Wingwalls parallel (extension of sides): square-edged at crown	0.7
Side- or slope-tapered inlet	0.2

Slug Flow

When the flow becomes unstable, a phenomenon termed slug flow may occur. In this condition the flow oscillates between inlet control and outlet control due to the following instances:

- ◆ Flow is indicated as supercritical, but the tailwater level is relatively high.
- ◆ Uniform depth and critical depth are relatively high with respect to the culvert barrel depth.
- ◆ Uniform depth and critical depth are within about 5% of each other.

The methods recommended in this chapter accommodate the potential for slug flow to occur by assuming the higher of inlet and outlet control headwater.

Determination of Outlet Velocity

The outlet velocity, v_o , depends on the culvert discharge (Q) and the cross-sectional area of flow at the outlet (A_o) as shown in Equation 8-17.

$$v_o = \frac{Q}{A_o}$$

Equation 8-17.

1. Assign the variable d_o as the depth with which to determine the cross-sectional area of flow at the outlet.
2. For outlet control, set the depth, d_o , equal to the higher of critical depth (d_c) and tailwater depth (TW) as long as the value is not higher than the barrel rise (D) as shown in Figure 8-13.
3. If the conduit will flow full at the outlet, usually due to a high tailwater or a conduit capacity lower than the discharge, set d_o to the barrel rise (D) so that the full cross-sectional area of the conduit is used as shown in Figure 8-14.

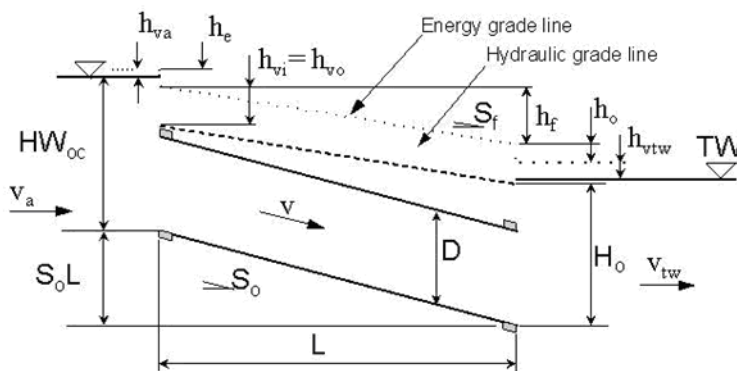

Figure 8-13. Cross Sectional Area based on the Higher of Critical Depth and Tailwater

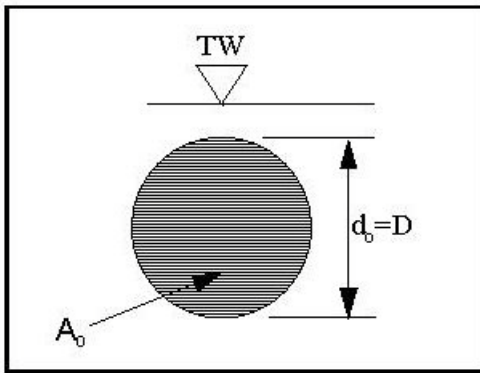

Figure 8-14. Cross Sectional Area Based on Full Flow

Depth Estimation Approaches

For inlet control under steep slope conditions, estimate the depth at the outlet using one of the following approaches:

- ◆ Use a step backwater method starting from critical depth (d_c) at the inlet and proceed downstream to the outlet. If the tailwater is lower than critical depth at the outlet, calculate the velocity resulting from the computed depth at the outlet. If the tailwater is higher than critical depth, a hydraulic jump within the culvert is possible. The [Hydraulic Jump in Culverts](#) subsection below discusses a means of estimating whether the hydraulic jump occurs within the culvert. If the hydraulic jump does occur within the culvert, determine the outlet velocity based on the outlet depth, $d_o = H_o$.
- ◆ Assume uniform depth at the outlet. If the culvert is long enough and tailwater is lower than uniform depth, uniform depth will be reached at the outlet of a steep slope culvert. For a short, steep culvert with tailwater lower than uniform depth, the actual depth will be higher than uniform depth but lower than critical depth. This assumption will be conservative; the estimate of velocity will be somewhat higher than the actual velocity. If the tailwater is higher than critical depth, a hydraulic jump is possible and the outlet velocity could be significantly lower than the velocity at uniform depth.

Direct Step Backwater Method

The Direct Step Backwater Method uses the same basic equations as the Standard Step Backwater Method but is simpler to use because no iteration is necessary. In the Direct Step Method, an increment (or decrement) of water depth (δd) is chosen and the distance over which the depth change occurs is computed. The accuracy depends on the size of δd . The method is appropriate for prismatic channel sections such as occur in most conduits. It is useful for estimating supercritical profiles and subcritical profiles.

1. Choose a starting point and starting water depth (d_1). This starting depth depends on whether the profile is supercritical or subcritical. Generally, for culverts, refer to outlet depth and set d_1 to the value of H_0 . Otherwise, you may use the following conditions to establish d_1 :
 - For a mild slope ($d_c < d_u$) and free surface flow at the outlet, begin at the outlet end. Select the higher of critical depth (d_c) and tailwater depth (TW). Supercritical flow may occur in a culvert on a mild slope. However, most often, the flow will be subcritical when mild slopes exist. Check this assumption.
 - For a steep slope ($d_c > d_u$), where the tailwater exceeds critical depth but does not submerge the culvert outlet, begin at the outlet with the tailwater as the starting depth.
 - For a steep slope in which tailwater depth is lower than critical depth, begin the water surface profile computations at the culvert entrance starting at critical depth and proceed downstream to the culvert exit. This implies inlet control, in which case the computation may be necessary to determine outlet velocity but not headwater.
 - For a submerged outlet in which free surface flow begins along the barrel, use the barrel depth, D , as the starting depth. Begin the backwater computations at the location where the hydraulic grade line is coincident with the soffit of the culvert.
2. The following steps assume subcritical flow on a mild slope culvert for a given discharge, Q , through a given culvert of length, L , at a slope, S_o . Calculate the following at the outlet end of the culvert based on the selected starting depth (d_1):
 - cross-section area of flow, A
 - wetted perimeter, WP
 - velocity, v , from Equation 8-17
 - velocity head, h_v , using Equation 8-9
 - specific energy, E , using Equation 8-18
 - friction slope, S_f , using Equation 8-13.

Assign the subscript 1 to the above variables (A_1 , WP_1 , etc.).

$$E = d + \frac{v^2}{2g}$$

Equation 8-18.

where:

E = specific energy (ft. or m)

d = depth of flow (ft. or m)

v = average velocity of flow (fps or m/s)

g = gravitational acceleration = 32.2 ft/s² or 9.81 m/s².

3. Choose an increment or decrement of flow depth, δd : if $d_1 > d_u$, use a decrement (negative δd); otherwise, use an increment. The increment, δd , should be such that the change in adjacent velocities is not more than 10%.
4. Calculate the parameters A , WP , v , E , and S_f at the new depth, $d_2 = d_1 + \delta d$, and assign the subscript 2 to these (e.g., A_2 , WP_2 , etc.).
5. Determine the change in energy, δE , using Equation 8-19.
6. Calculate the arithmetic mean friction slope using Equation 8-20.
7. Using Equation 8-21, determine the distance, δL , over which the change in depth occurs.
8. Consider the new depth and location to be the new starting positions (assign the subscript 1 to those values currently identified with the subscript 2) and repeat steps 3 to 7, summing the incremental lengths, δL , until the total length, ΣL , equals or just exceeds the length of the culvert. You may use the same increment throughout or modify the increment to achieve the desired resolution. Such modifications are necessary when the last total length computed far exceeds the culvert length and when high friction slopes are encountered. If the computed depth reaches the barrel rise (D) before reaching the culvert inlet, skip step 9 and refer to the [Type AB full flow losses](#) to complete the analysis.
9. The last depth (d_2) established is the depth at the inlet (H_i) and the associated velocity is the inlet, v_i . Calculate the headwater using Equation 8-15.

$$\delta E = E_2 - E_1$$

Equation 8-19.

$$S_f = \frac{(S_{f2} + S_{f1})}{2}$$

Equation 8-20.

$$\delta L = \frac{\delta E}{S_o - S_f}$$

Equation 8-21.

Subcritical Flow and Steep Slope

The procedure for subcritical flow ($d > d_c$) but steep slope ($d_c > d_u$) is similar with the following exceptions:

- ◆ Choose a decrement in depth, $\delta d = \text{negative}$.
- ◆ If the depth, d , reaches critical depth before the inlet of the culvert is reached, the headwater is under inlet control ([Headwater Under Inlet Control](#)) and a [hydraulic jump](#) may occur in the culvert barrel (refer to the following subsection for discussion of the hydraulic jump in culverts).

- ◆ If the depth at the inlet is higher than critical depth, determine the outlet control head using Equation 8-15 as discussed in the [Energy Balance at Inlet](#) subsection. A hydraulic jump may occur within the culvert.

Supercritical Flow and Steep Slope

The procedure for supercritical flow ($d < d_c$) and steep slope is similar with the following exceptions:

- ◆ Begin computations at critical depth at the culvert entrance and proceed downstream.
- ◆ Choose a decrement of depth, δd .
- ◆ If the tailwater is higher than critical depth, a hydraulic jump may occur within the culvert (refer to the following subsection for discussion of the hydraulic jump).

Hydraulic Jump in Culverts

Figure 8-15 provides a sample plot of depth and momentum function and an associated specific energy plot. For a given discharge and given energy and momentum, there exist two possible depths, one less than critical depth (supercritical flow) a sequent (or conjugate) depth greater than critical depth (subcritical flow). With a proper configuration, the water flowing at the lower depth in supercritical flow can “jump” abruptly to its sequent depth in subcritical flow. This is called a hydraulic jump. With the abrupt change in flow depth comes a corresponding change in cross-sectional area of flow and a resulting decrease in average velocity.

By comparing the two curves at a supercritical depth and its sequent depth, it is apparent that the hydraulic jump involves a loss of energy. Also, the momentum function defines critical depth as the point at which minimum momentum is established.

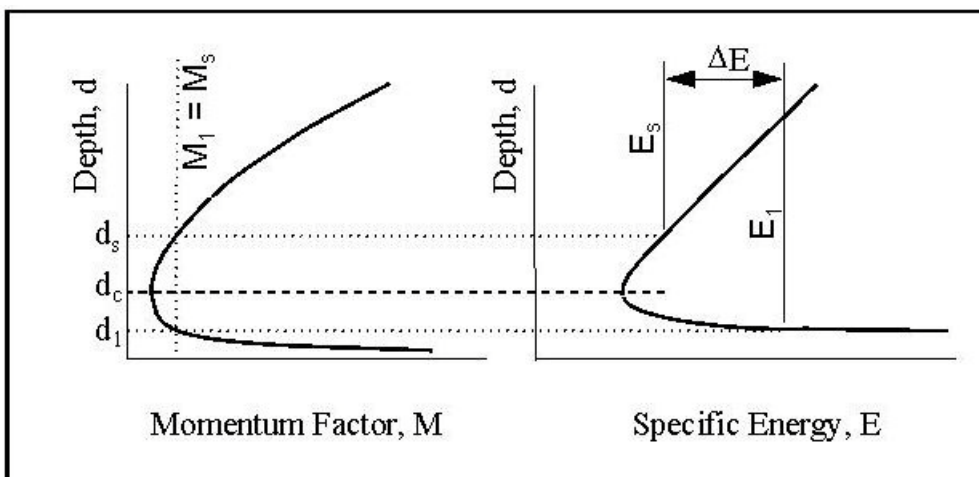

Figure 8-15. Momentum Function and Specific Energy

The balance of forces is represented using a momentum function (Equation 8-22):

$$M = \frac{Q^2}{gA} + A\bar{d}$$

Equation 8-22.

where:

M = momentum function

Q = discharge (cfs or m³/s)

g = gravitational constant = 32 ft./sec²

A = section area of flow (sq. ft. or m²)

\bar{d} = distance from water surface to centroid of flow area (ft. or m).

The term $A\bar{d}$ represents the first moment of area about the water surface. Assuming no drag forces or frictional forces at the jump, conservation of momentum maintains that the momentum function at the approach depth, M_1 , is equal to the momentum function at the sequent depth, M_2 .

The potential occurrence of the hydraulic jump within the culvert is determined by comparing the outfall conditions with the sequent depth of the supercritical flow depth in the culvert. The conditions under which the hydraulic jump is likely to occur depend on the slope of the conduit.

Under mild slope conditions ($d_c < d_u$) with supercritical flow in the upstream part of the culvert, the following two typical conditions could result in a hydraulic jump:

- ◆ The potential backwater profile in the culvert due to the tailwater is higher than the sequent depth computed at any location in the culvert.
- ◆ The supercritical profile reaches critical depth before the culvert outlet.

Under steep slope conditions, the hydraulic jump is likely only when the tailwater is higher than the sequent depth.

Sequent Depth

A direct solution for sequent depth, d_2 is possible for free surface flow in a rectangular conduit on a flat slope using Equation 8-23. If the slope is greater than about 10 percent, a more complex solution is required to account for the weight component of the water. FHWA [Hydraulic Engineering Circular 14](#) provides more detail for such conditions.

$$d_2 = 0.5d_1 \left(\sqrt{1 + \frac{8v_1^2}{gd_1}} - 1 \right)$$

Equation 8-23.

where:

d_s = sequent depth, ft. or m

d_1 = depth of flow (supercritical), ft. or m

v_1 = velocity of flow at depth d , ft./s or m/s.

A direct solution for sequent depth in a circular conduit is not feasible. However, an iterative solution is possible by following these equations:

- ◆ Select a trial sequent depth, d_s , and apply Equation 8-24 until the calculated discharge is equal to the design discharge. Equation 8-24 is reasonable for slopes up to about 10 percent.
- ◆ Calculate the first moments of area for the supercritical depth of flow, d_1 , and sequent depth, d_s , using Equation 8-25.
- ◆ This equation uses the angle β shown in Figure 8-16, which you calculate by using Equation 8-26.

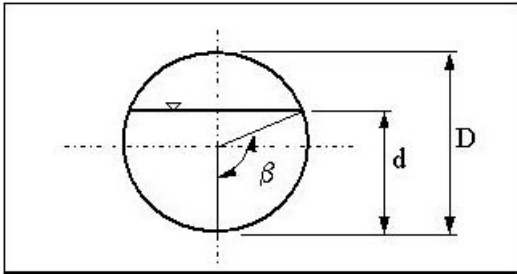

Figure 8-16. Determination of Angle β

CAUTION: Some calculators and spreadsheets may give only the principal angle for β in Equation 8-26 (i.e., $-\pi/2$ radians $\leq \beta \leq \pi/2$ radians).

- ◆ Use Equation 8-27 to calculate the areas of flow for the supercritical depth of flow and sequent depth.

$$Q^2 = \frac{g(A_s \bar{d}_s - A_1 \bar{d}_1)}{1/A_1 - 1/A_s}$$

Equation 8-24.

where:

Q = discharge, cfs or m^3/s

A_s = area of flow at sequent depth, sq.ft. or m^2

$A_s \bar{d}_s$ = first moment of area about surface at sequent depth, cu.ft. or m^3

$A_1 \bar{d}_1$ = first moment of area about surface at supercritical flow depth, cu.ft. or m^3 .

$$A\bar{d} = \frac{D^3}{24} (3 \sin \beta - \sin^3 \beta - 3\beta \cos \beta)$$

Equation 8-25.

where:

$A\bar{d}$ = first moment of area about water surface, cu.ft. or m³

D = conduit diameter, ft. or m

β = angle shown in Figure 8-16 and calculated using Equation 8-26.

$$\beta = \cos^{-1} \left(1 - \frac{2d}{D} \right)$$

Equation 8-26.

$$A = \frac{D^2}{8} \left[2 \cos^{-1} \left(1 - \frac{2d}{D} \right) - \sin \left(2 \cos^{-1} \left(1 - \frac{2d}{D} \right) \right) \right]$$

Equation 8-27.

Equation 8-24 applies to other conduit shapes having slopes of about 10 percent or less. The first moment of area about the surface, $A\bar{d}$, is dependent on the shape of the conduit and depth of flow. A relationship between flow depth and first moment of area must be acquired or derived.

Roadway Overtopping

Where water flows both over the roadway and through a culvert (see Figure 8-17), a flow distribution analysis is required to define the hydraulic characteristics. This is a common occurrence where a discharge of low design AEP (low probability of occurrence) is applied to a facility designed for a lower design frequency.

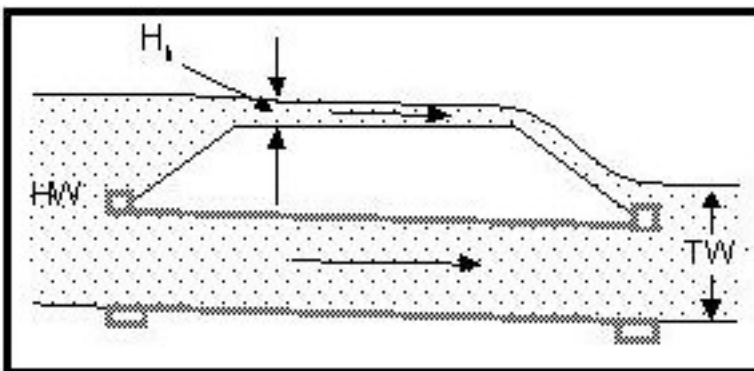

Figure 8-17. Culvert with Overtopping Flow

For example, a complete design involves the application and analysis of a 1% AEP discharge to a hydraulic facility designed for a much smaller flood. In such a case, the headwater may exceed the

low elevation of the roadway, causing part of the water to flow over the roadway embankment while the remainder flows through the structure. The headwater components of flow form a common headwater level. An iterative process is used to establish this common headwater.

The following procedure is an iterative approach that is reasonable for hand computations and computer programs:

1. Initially assume that all the runoff (analysis discharge) passes through the culvert, and determine the headwater. Use the procedures outlined in the [Culvert Design](#) section. If the headwater is lower than the low roadway elevation, no roadway overtopping occurs and the analysis is complete. Otherwise, proceed to step 2.
2. Record the analysis discharge as the initial upper flow limit and zero as the initial lower flow limit. Assign 50% of the analysis discharge to the culvert and the remaining 50% to the roadway as the initial apportionment of flow.
3. Using the procedures outlined in the [Design Guidelines and Procedure for Culverts](#) section, determine the headwater with the apportioned culvert flow.
4. Compute the roadway overflow (discharge) required to subtend the headwater level determined in step 3 using Equation 8-28.

$$Q = k_t CLH_h^{1.5}$$

Equation 8-28.

where:

Q = discharge (cfs or m³/s)

k_t = over-embankment flow adjustment factor (see Figure 8-18)

C = discharge coefficient (use 3.0 – English or 1.66 metric for roadway overtopping)

L = horizontal length of overflow (ft. or m). This length should be perpendicular to the overflow direction. For example, if the roadway curves, the length should be measured along the curve.

H_h = average depth between headwater and low roadway elevation (ft. or m).

- Base the value H_h on the assumption that the effective approach velocity is negligible. For estimation of maximum headwater, this is a conservative assumption. However, under some conditions, such as the need to provide adequate detention storage, you may need to consider the approach velocity head ($v^2/2g$). That is, replace H_h in Equation 8-28 with $H_h + v^2/2g$.
- With reference to Figure 8-19, the flow over the embankment will not be affected by tail-water if the excess (H_t) is lower than critical depth of flow over the road (approximately $0.67 H_h$). For practical purposes, H_t/H_h may approach 0.8 without any correction coefficient. For H_t/H_h values above 0.8 use Figure 8-18 to determine k_t .

- For most cases of flow over highway embankments, the section over which the discharge must flow is parabolic or otherwise irregular (see Figure 8-20). In such cases, it becomes necessary to divide the section into manageable increments and to calculate individual weir flows for the incremental units, summing them for total flow.
- If the tailwater is sufficiently high, it may affect the flow over the embankment. In fact, at high depth, the flow over the road may become open channel flow, and weir calculations are no longer valid. At extremely high depth of roadway overtopping, it may be reasonable to ignore the culvert opening and compute the water surface elevation based on open channel flow over the road.

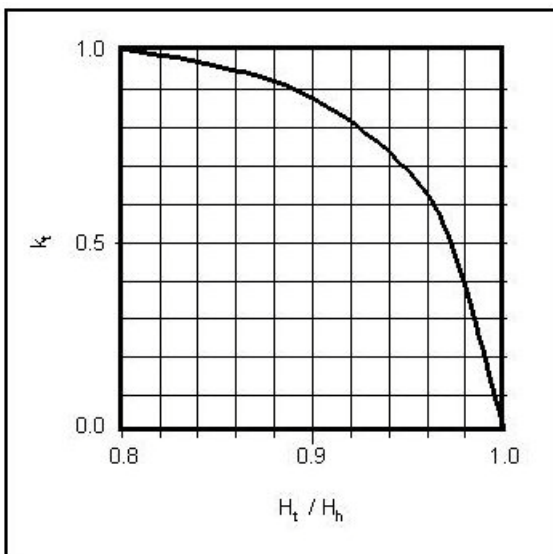

Figure 8-18. Over Embankment Flow Adjustment Factor

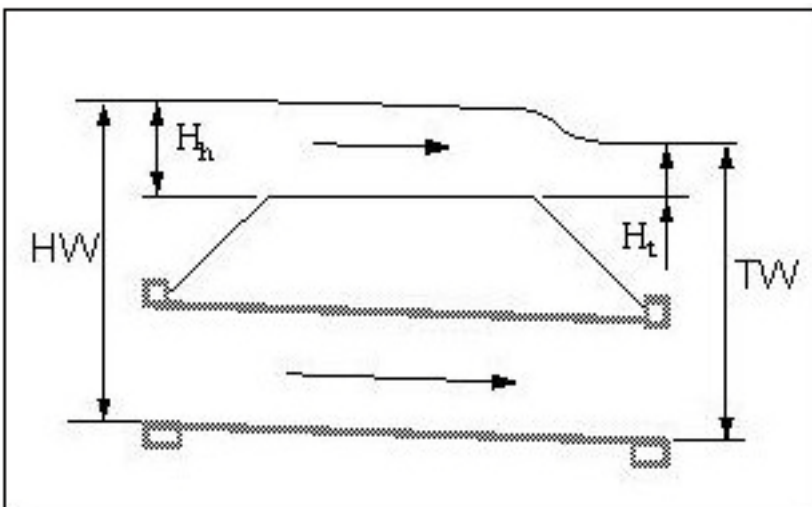

Figure 8-19. Roadway Overtopping with High Tailwater

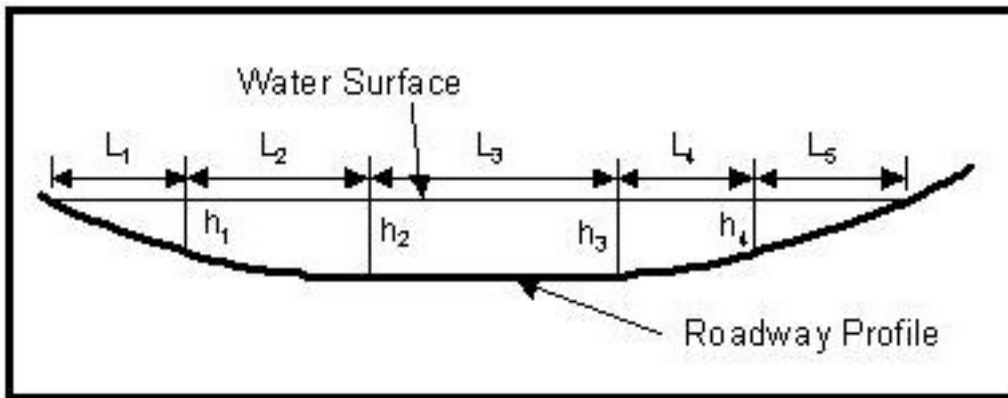

Figure 8-20. Cross Section of Flow over Embankment

5. Add the calculated roadway overflow to the culvert flow. If the calculated total is greater than the analysis discharge, record the current culvert flow apportionment as the current upper flow limit and set the new culvert flow apportionment at a value halfway between the current upper and lower flow limits. If the calculated total is less than the analysis discharge, record the current culvert flow apportionment as the lower flow limit for the culvert and set the new culvert flow apportionment at a value halfway between the current upper and lower flow limits.
6. Repeat steps 3 to 5, using the culvert flow apportionment established in step 5, until the difference between the current headwater and the previous headwater is less than a reasonable tolerance. For computer programs, the department recommends a tolerance of about 0.1 in. The current headwater and current assigned culvert flow and calculated roadway overflow can then be considered as the final values.

Performance Curves

For any given culvert, the control (outlet or inlet) might vary with the discharge. Figure 8-18 shows sample plots of headwater versus discharge for inlet and outlet control. The envelope (shown as the bold line) represents the highest value of inlet and outlet headwater for any discharge in the range. This envelope is termed a performance curve.

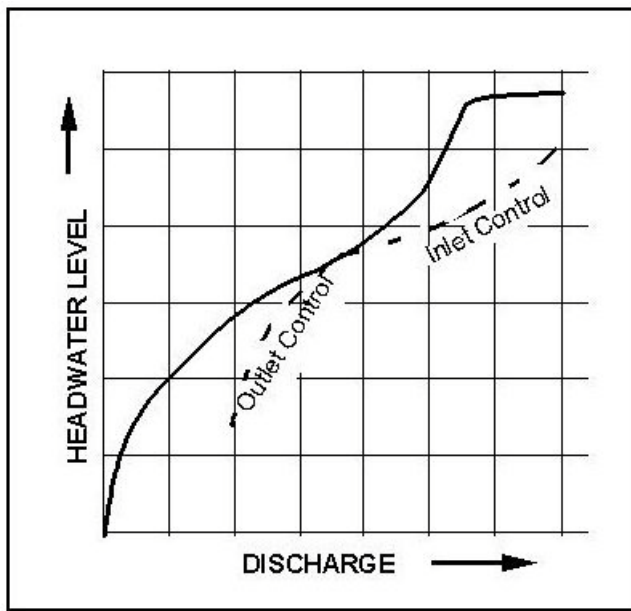

Figure 8-21. Typical Performance Curve

In this example, inlet control prevails at lower discharges and flow transitions to outlet control as the discharge increases. The flatter portion represents the effect of roadway overflow. The performance curve can be generated by calculating the culvert headwater for increasing values of discharge. Such information is particularly useful for performing risk assessments and for hydrograph routing through detention ponds and reservoirs.

Exit Loss Considerations

The traditional assumption in the design of typical highway culverts is continuity of the hydraulic grade line. At the outlet, this implies that when the tailwater is higher than critical depth and sub-critical flow exists, the hydraulic grade line immediately inside the barrel is equal to the tailwater level. This is reasonable for most normal culvert designs for TxDOT application. However, by inference there can be no accommodation of exit losses because the energy grade line immediately inside the culvert can only be the hydraulic grade line plus the velocity head, no matter what the velocity is in the outfall.

Occasionally, an explicit exit loss may need to be accommodated. Some examples are as follows:

- ◆ conformance with another agency's procedures
- ◆ comparison with computer programs (such as HEC-RAS)
- ◆ design of detention pond control structures in which storage volumes are sensitive to small changes in elevation.

If such a need arises, base the starting hydraulic grade level (H_0) is based on balancing [Equation 8-29](#) between the outside and inside of the culvert face at the outlet. A common expression for exit

loss appears in Equation 8-30. This assumes that the tailwater velocity (v_{TW}) is lower than the culvert outlet velocity (v_o) and the tailwater is open to the atmosphere. If the above approach is used, it is most likely that the outlet depth (H_o) will be lower than the tailwater. This conforms to basic one-dimensional hydrostatic principles.

$$H_o + \frac{v_o^2}{2g} = TW + \frac{v_{TW}^2}{2g} + h_o$$

Equation 8-29.

where:

H_o = outlet depth - depth from the culvert flow line to the hydraulic grade line inside the culvert at the outlet (ft. or m)

v_o = culvert outlet velocity (ft./s or m/s)

v_{TW} = velocity in outfall (tailwater velocity) (ft./s or m/s)

h_o = exit loss (ft. or m).

$$h_o = K \frac{v_o^2 - v_{TW}^2}{2g}$$

Equation 8-30.

where:

K = loss coefficient which typically varies from 0.5 to 1.

Section 4 — Improved Inlets

Inlet Use

An improved inlet serves to funnel the flow into the culvert to remove the point of control from the face of the inlet to a throat located downstream from the face. The normal contraction of flow is included in the transition from the face to the throat. An improved inlet may be economical if the culvert is operating under inlet control, but not if the culvert is operating under outlet control.

An improved inlet may offer the advantage of increasing the capacity of an existing culvert that has become inadequate because of changes in the watershed which have increased the discharge to the culvert. Improved inlets are not recommended because of the following disadvantages:

- ◆ Available design procedures cannot accommodate an improved inlet when the face of the inlet is skewed instead of normal.
- ◆ Heavy debris loads that can pass through the inlet face may become lodged in the restriction at the throat.
- ◆ The reduction at the throat may push the culvert into outlet control which will negate any advantages of the improved inlet.
- ◆ Improved inlets are usually costly to construct when compared with standard inlets.

Careful consideration should be given before selecting and using an improved inlet design. Guidelines for design can be found in FHWA publication, Hydraulic Design of Highway Culverts, [HDS-5](#).

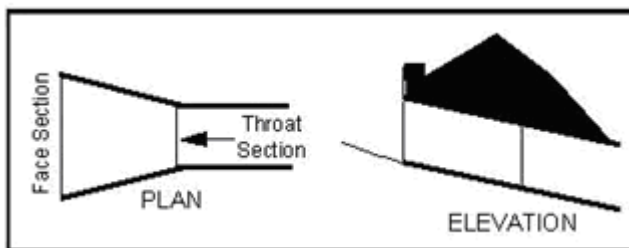

Figure 8-22. Side Tapered Inlet

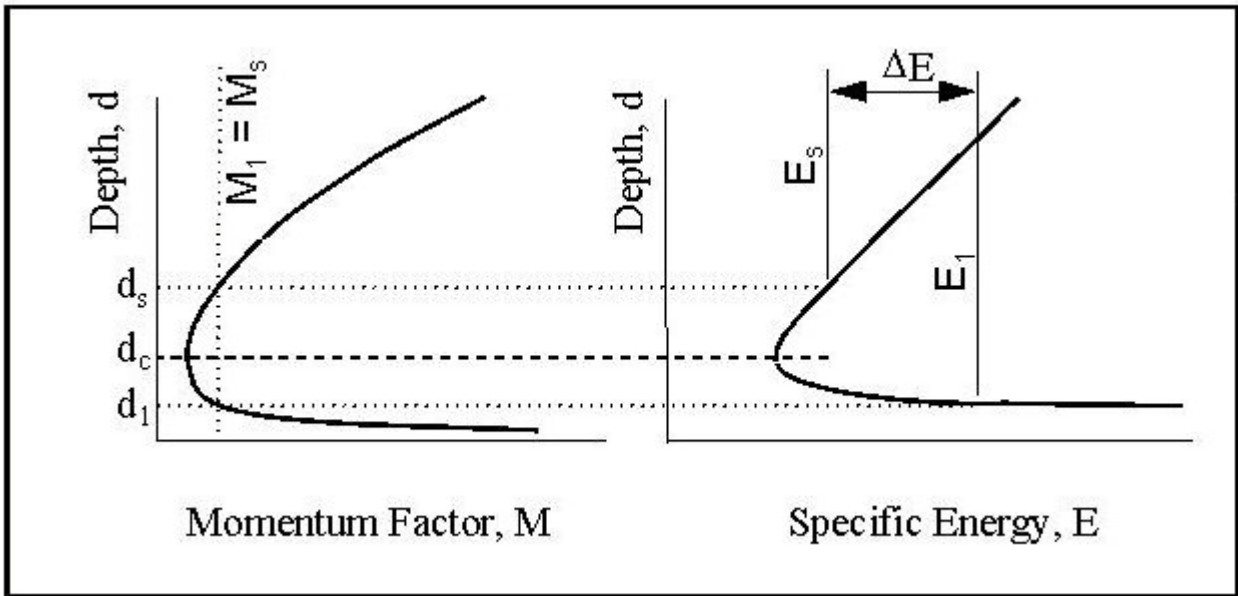

Figure 8-23. Slope Tapered Inlet

Section 5 — Velocity Protection and Control Devices

Excess Velocity

Several possible solutions are available for both protection and control to minimize the negative effects of excessive velocity. Solutions are categorized as either velocity protection devices or velocity control devices.

Velocity Protection Devices

A velocity protection device does not necessarily reduce excessive velocity but does protect threatened features from damage. Such devices are usually economical and effective in that they serve to provide a physical interim for the flow to return to a more natural velocity. The protection devices discussed here include the following:

- ◆ Channel liner -- Most of the various types of channel liner have proven effective for erosion protection. Some types of channel liner include low quality concrete (lightly reinforced), rock, soil retention blankets, articulated concrete blocks, and revetment mattresses. Channel liners, when used as an outlet velocity protection measure, should be applied to the channel area immediately downstream of the culvert outlet for some distance, possibly to the right of way line and beyond (with appropriate easement). (See Chapter 6 for types and guidelines.) These liners, however, are viewed as creating environment problems, including decreased habitat and increased water temperature. They also are viewed to increase impervious cover, decrease time of concentration, and change the hydrograph timing downstream. In many instances, the liner may stabilize the area in question, only to have the problem shift downstream to where the channel is not lined.
- ◆ Pre-formed outlets - Pre-formed outlets approximate a natural scour hole but protect the stream bed while dissipating energy. These have been shown to be effective protection in areas threatened by excessive outlet velocities. Such appurtenances should be lined with some type of riprap. (A velocity appurtenance for a culvert may be classified broadly as either a protection device or a control device.)
- ◆ Channel recovery reach -- Similar to a pre-formed outlet, a channel recovery reach provides a means for the flow to return to an equilibrium state with the natural, unconfined stream flow. The recovery reach should be well protected against the threat of scour or other damage.

Velocity Control Devices

A velocity control device serves to effectively reduce an excessive culvert outlet velocity to an acceptable level. The design of some control devices is based analytically while, for others, the specific control may be unpredictable. Some velocity control devices are as follows:

- ◆ Natural hydraulic jumps (most control devices are intended to force a hydraulic jump) -- Most velocity control devices rely on the establishment of a hydraulic jump. Because a culvert being on a relatively steep slope usually results in excessive outlet velocity from the culvert, the depth downstream of the culvert exit is usually not great enough to induce a hydraulic jump. However, some mechanisms may be available to provide a simulation of a greater depth necessary to create a natural hydraulic jump.
- ◆ Broken-back culvert configuration -- One mechanism for creating a hydraulic jump is the broken back configuration, two types of which are depicted in Figure 8-26 and Figure 8-27. When used appropriately, a broken back culvert configuration can influence and contain a hydraulic jump. However, there must be sufficient tailwater, and there should be sufficient friction and length in unit 3 (see Figure 8-26 and Figure 8-27) of the culvert. In ordinary circumstances for broken back culverts, you may need to employ one or more devices such as roughness baffles to create a high enough tailwater.
- ◆ Sills -- The use of the sill is effective in forcing a hydraulic jump in culverts. One disadvantage of sills is the possible susceptibility for silting. Sills must usually be maintained frequently to keep it free of sediment deposition. Another disadvantage is the waterfall effect that they usually cause. Riprap should be installed immediately downstream of the sill for a minimum distance of 10 feet to protect features from the turbulence of the waterfall effect.

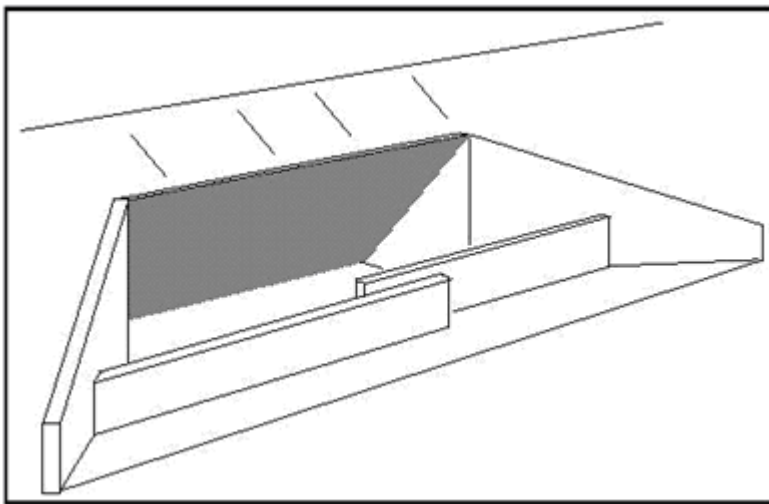

Figure 8-24. Sills

- ◆ Roughness baffles -- Roughness baffles, sometimes referred to as 'dragon's teeth', can be effective in inducing turbulence, dissipating energy, and reducing culvert outlet velocity (see Figure 8-25). Care must be taken in the design and placement of the baffles; if the baffles are too small or placed too far apart, they are ineffective. In addition, they may interfere with mowing operations around the culvert outlet. If these become damaged or broken from being hit by a mower, they are ineffective. To limit the amount of potential damage, baffles must be reinforced with rebar.

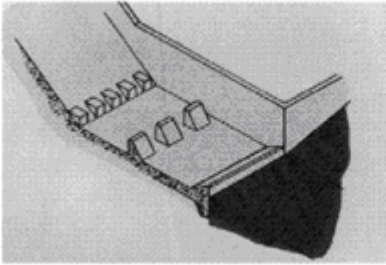

Figure 8-25. Roughness Baffles

- ◆ Energy dissipators -- An efficient but usually expensive countermeasure is an energy dissipator. Some energy dissipators have an analytical basis for design while others are intended to cause turbulence in unpredictable ways. With turbulence in flow, energy is dissipated and velocity can be reduced.

Other controls are described in the FHWA publication Hydraulic Design of Energy Dissipators for Culverts and Channels, HEC-14.

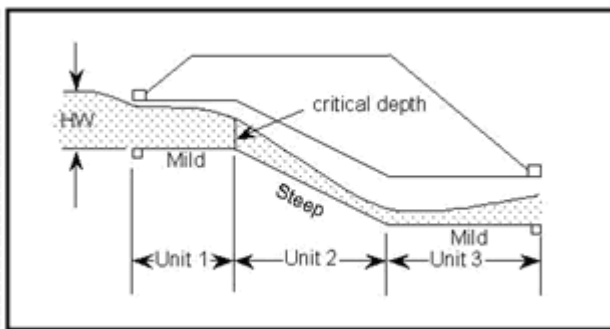

Figure 8-26. Three Unit Broken Back Culvert

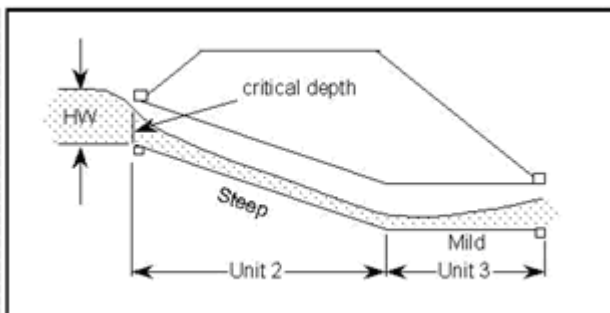

Figure 8-27. Two Unit Broken Back Culvert

Broken Back Design and Provisions Procedure

The design of a broken back culvert is not particularly difficult, but it requires reducing velocity at the outlet. Use the following procedure:

1. With design discharge and an associated tailwater, establish the flow line profile using the following considerations:
 - With reference to Figure 8-26 and Figure 8-27, unit 3 should be as long enough to ensure that the hydraulic jump occurs within the culvert.
 - For a given total drop, the resulting length of unit 2 is short, but this may cause the slope of unit 2 to be very steep.
 - Provided that unit 1 is on a mild slope, its length has no effect on the outlet velocity of any downstream hydraulic function. It is recommended that unit 1 either not be used or be very short; the result is additional latitude for adjustment in the profiles of units 2 and 3.
 - A longer unit 3 and a milder (but still steep) slope in unit 2 together enhance the possibility of a hydraulic jump within the culvert. However, these two conditions are contradictory and usually not feasible for a given culvert location. Make some compromise between the length of unit 3 and the slope of unit 2. Unit 3 must be on a mild slope ($d_u > d_c$). This slope should be no greater than necessary to prevent ponding of water in the unit. Do not use an adverse (negative) slope.
2. Size the culvert initially according to the directions outlined in step 1 under Design Guidelines and [Procedure for Culverts](#).
 - If a unit 1 is used, the headwater will most likely result from the backwater effect of critical depth between units 1 and 2.
 - If a unit 1 is not used, the headwater will most likely result from inlet control.
3. Starting at the upstream end of unit 2, calculate a supercritical profile, beginning at critical depth and working downstream through unit 3. The [Direct Step Backwater Method](#) is appropriate. Note the following:
 - Critical depth will not change from one unit to the next, but uniform depth will vary with the slope of the unit.
 - The increment, δd , should be such that the change in adjacent velocities is not more than 10%.
 - The depth in unit 2 should tend to decrease towards uniform depth, so δd should be negative. The resulting profile is termed an S2 curve.
 - Also, δd should be small enough when approaching unit 3 such that the cumulative length does not far exceed the beginning of unit 3.
 - For hand computations, an acceptable expedient is to omit the profile calculation in unit 2 and assume that the exit depth from unit 2 is equal to uniform depth in unit 2.
4. When you reach unit 3, complete the profile computations with the following considerations.
 - Because uniform depth is now greater than critical depth (mild slope), and flow depth is lower than critical depth, the flow depth tends to increase towards critical depth. Therefore, in unit 3, δd should be positive.
 - The starting depth for unit 3 is the calculated depth at the end of unit 2.

- Reset the cumulative length, ΣL , to zero.
- The resulting water surface profile is termed an M3 curve.

As the profile is calculated, perform the checks outlined below:

- As each depth is calculated along unit 3, calculate the sequent depth, d_s . For more information, see the [Direct Step Backwater Method](#), [Hydraulic Jump in Culverts](#), and [Sequent Depth](#) subsections in Section 3.
 - Calculate the elevation of sequent depth ($d_s +$ flow line elevation) and compare it with the tailwater elevation. Tailwater elevation may be a natural stream flow elevation, or may be produced artificially by installing a sill on the downstream apron between wingwalls. Design Division Hydraulics does not recommend the use of sills. (see [Velocity Control Devices](#)). If sills are used, the total vertical dimension of the artificial tailwater is determined by adding the elevation at the top of the sill and the critical depth of design discharge flow over the sill. Base this critical depth on the rectangular section formed by the top of the sill and the two vertical wingwalls. If the elevation of sequent depth is lower than the tailwater elevation, the following points apply; go to Step 5:
 - Hydraulic jump is likely to occur within the culvert.
 - Outlet velocity is based on the lower of tailwater depth, TW, and barrel height, D.
 - Profile calculations may cease even though the end of the barrel has not been reached.
 - If the computed profile tends towards critical depth before reaching the end of the culvert, the following apply and you should go to Step 5:
 - Hydraulic jump is likely to occur within the culvert.
 - Outlet depth will be equal to critical depth and outlet velocity is based on critical depth.
 - Profile calculations may cease even though the end of the barrel has not been reached.
 - Compare the cumulative length, ΣL , to unit 3 length. If $\Sigma L \geq$ length of unit 3, the following apply:
 - Hydraulic jump does not form within the length of unit 3.
 - Exit depth is the present value of d .
 - Exit velocity is based on exit depth.
 - The broken-back culvert configuration is ineffective as a velocity control device and should be changed in some manner. Alternatives include rearrangement of the culvert profile, addition of a sill, and investigation of another device. If the profile is reconfigured, go back to step 3. Otherwise, skip step 5 and seek alternative measures.
5. Consider hydraulic jump cautions. The hydraulic jump is likely to occur within the culvert for the design conditions. However, it is prudent to consider the following cautions:

- If tailwater is very sensitive to varying downstream conditions, it may be appropriate to check the occurrence of the hydraulic jump based on the lowest tailwater that is likely to occur.
- The hydraulic jump may not occur within the barrel under other flow conditions. It is wise to check the sensitivity of the hydraulic jump to varying flow conditions to help assess the risk of excessive velocities.
- If a sill has been employed to force an artificial tailwater, and the hydraulic jump has formed, the outlet velocity calculated represents the velocity of water as it exits the barrel. However, the velocity at which water re-enters the channel is the crucial velocity. This velocity would be the critical velocity of sill overflow.

Energy Dissipators

Impact basins are effective energy dissipators but are relatively expensive structures (see Figure 8-28).



Figure 8-28. Impact Basins

Stilling basins are hydraulically similar to sills (Figure 8-29). However, they are more expensive in construction and could present serious silting problems. A chief advantage in stilling basins is the lack of a waterfall effect.

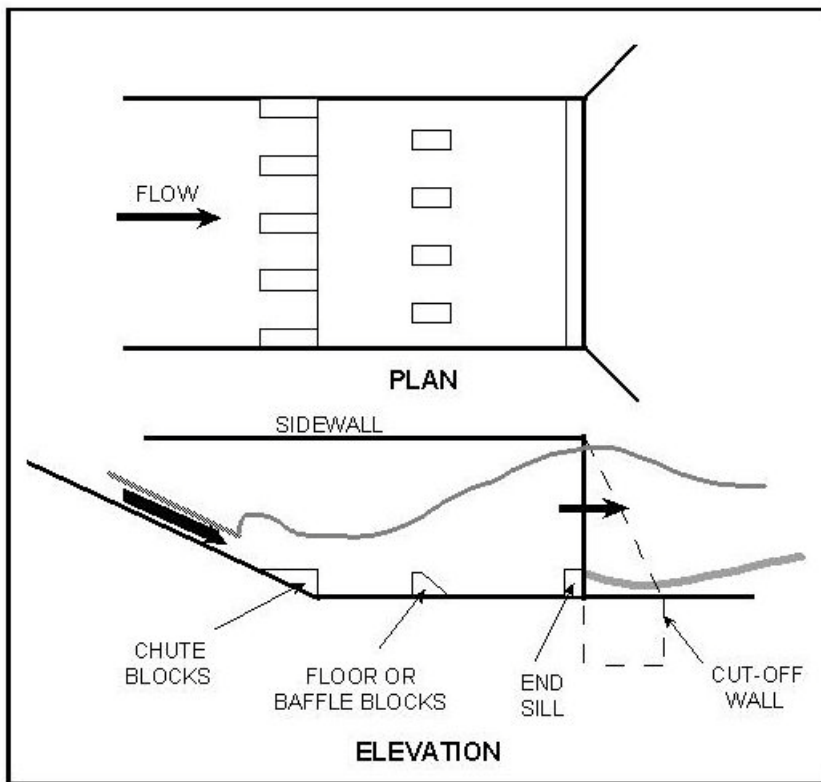

Figure 8-29. Stilling Basins

Radial energy dissipators are quite effective but extremely expensive to construct and, therefore, not ordinarily justified (Figure 8-30). They function on the principle of a circular hydraulic jump. For a detailed discussion on dissipator types, along with a variety of design methods for velocity control devices, refer to [HEC-14](#).

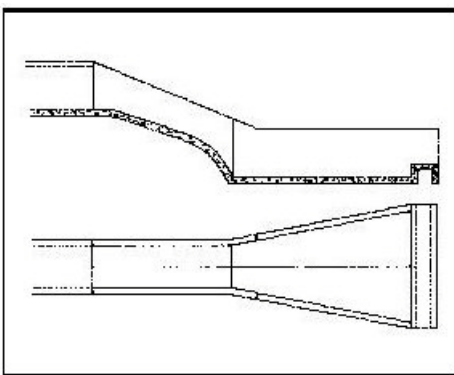

Figure 8-30. Radial Flow Energy Dissipator

Section 6 — Special Applications

Detour Culverts

Temporary culverts are usually installed in detours or emergency replacements of permanent culverts and bridges. The design must include consideration for soil protection to prevent erosion of the embankment and silting of the stream (Waters of the U.S.). Figure 8-31 shows an example of both problems on one temporary structure.



Figure 8-31. Temporary or Detour Culverts

Risk

Stream crossings for detours are normally built to higher AEP (lower flow) flood events than crossings designed for the highway. This may be good practice both hydraulically and economically. It follows that the hydraulic design of a detour stream crossing should be based on risk factors. Risk factors that should be evaluated include the probability of flooding during the anticipated service life of the detour (the construction period for the bridge or culvert), the risk to life and property from excessive backwaters and washouts, traffic service requirements, school bus routes, and emergency routes. Common sense and sound engineering judgment should prevail in making decisions.

Equation 8-31 describes the risk of the occurrence of a given AEP flood that a project incurs during its construction life.

$$\bar{R} = 1 - (1 - AE)^n$$

Equation 8-31.

Where:

R = Risk (probability of occurrence) in decimal form.

$\bar{A}E$ = AEP of the flood event in decimal form.

n = duration in years of the project or the time requirement of the detour.

Equation 8-31 was used to generate the curves in Figure 8-32 for a family of curves for project lengths versus flood AEPs on the y axis and the resultant risk of occurrence on the x axis. Figure 8-32 demonstrates that during a one-year construction period, the odds are 4 to 1 against the occurrence of a flood as large as a 20% AEP event, and the chances are even (1 to 1) that the mean annual event will not be exceeded. The odds are 9 to 1 against the occurrence of a 10% AEP flood during a one-year construction and 2.7 to 1 against such an occurrence in a three-year construction period.

However, caution should be used with the graph. A one-year project which is to be started during one rainy or potential flood season and will finish during the next rainy or potential flood season really should be considered a two-year project for risk assessment, which means the odds are really even for risk instead of 4 to 1 against!

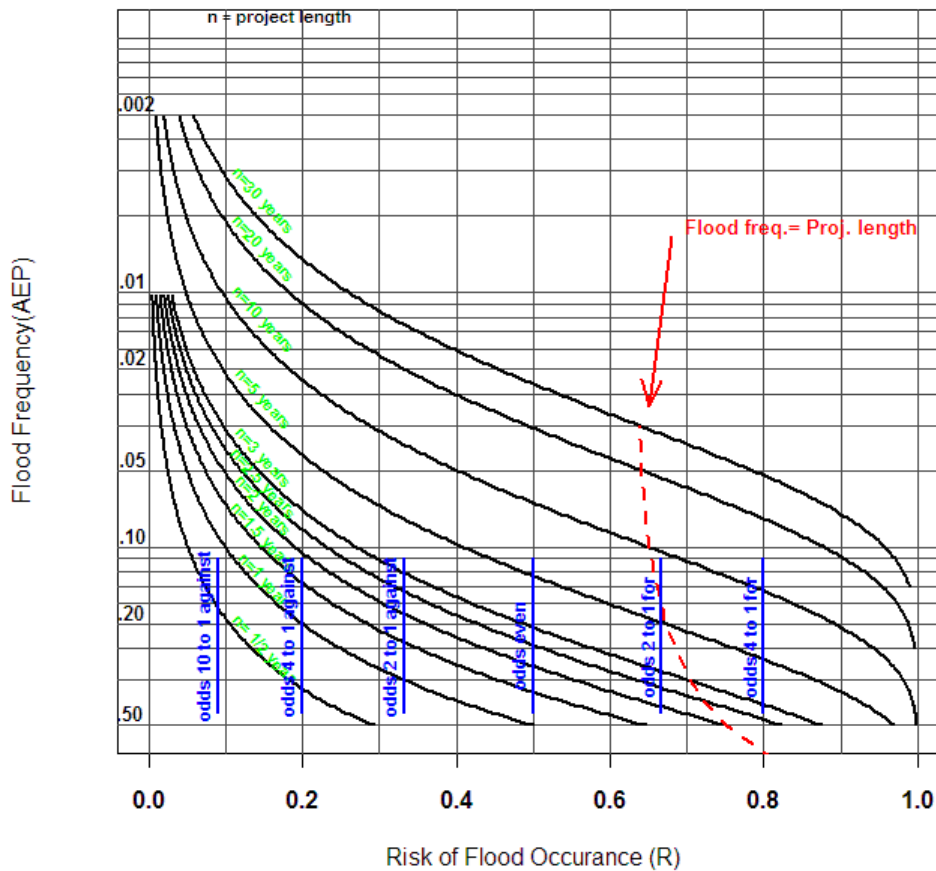

Figure 8-32. Graph was generated from Equation 8-31. The higher n values are not realistic, but were included for a sense of proportion.

Engineering Requirements

Detour culverts are not a contractor item, but shall be designed by a licensed Professional Engineer on sealed sheets which are part of the plan set. The Contractor shall not design a detour culvert as part of the construction project unless the design has been signed and sealed and submitted to TxDOT for approval.

Chapter 9 — Bridges

Contents:

[Section 1 — Introduction and Definitions](#)

[Section 2 — Planning and Location Considerations](#)

[Section 3 — Bridge Hydraulic Considerations](#)

[Section 4 — Hydraulics of Bridge Openings](#)

[Section 5 — Single and Multiple Opening Designs](#)

[Section 6 — Flood Damage Prevention](#)

[Section 7 — Appurtenances](#)

Section 1 — Introduction and Definitions

Hydraulically Designed Bridges

A bridge is defined in the *TxDOT Standard Specifications For Construction and Maintenance of Highways, Streets, and Bridges 2004* as a structure, including supports, erected over a depression or an obstruction (e.g., water, a highway, or a railway) having a roadway or track for carrying traffic or other moving loads, and having an opening measured along the center of the roadway of more than 20 feet between faces of abutments, spring lines of arches, or extreme ends of the openings for multiple box culverts. Bridges, as opposed to culverts, are not covered with embankment or designed to take advantage of submergence to increase hydraulic capacity, even though some are designed to be inundated under flood conditions.

Bridges enable streams to maintain flow conveyance and to sustain aquatic life. They are important and expensive highway hydraulic structures vulnerable to failure from flood related causes. In order to minimize the risk of failure, the hydraulic requirements of a stream crossing during the development, construction, and maintenance highway phases must be recognized and addressed.

This chapter addresses hydraulic engineering aspects of bridge stream crossings, including approach embankments and structures on floodplains. It does not provide detailed information on tidal areas such as bays and estuaries. Risk is discussed in Chapter 3, Section 3 [Evaluation of Risk](#).

Definitions

One-Dimensional Analysis – A steady state or standard step model, meaning that there is no direct modeling of the hydraulic effect of cross section shape changes, bends, and other two- and three-dimensional aspects of flow. HEC-1, WSPRO, and HEC-RAS are examples of a one-dimensional analysis models.

Two-Dimensional Analysis – A spatially distributed hydraulic model which models dynamic unsteady flow and is therefore capable of delivering results far more accurately and closer to real life than a steady state model. Dynamic models allow the effects of storage and backwater in conduits and floodplains and the timing of the hydrographs to yield a true representation of the HGL at any point in space and time. Two-dimensional analysis models require such a high level of expertise and time to run effectively that they are used for unusual situations.

Section 2 — Planning and Location Considerations

Introduction

Generally, a stream crossing location is selected during the planning and location phase of a highway project. The final location should be selected only after obtaining detailed survey information and completing preliminary hydraulic studies. Although they are not the sole consideration in bridge location and design, hydraulic aspects should receive major attention in the initial planning of the highway. The location and alignment of the highway can either magnify or eliminate hydraulic problems at the crossing. Adverse conditions should be identified in the early stages of new location selection so that potential problems receive adequate consideration. If the cost of the required structures is prohibitive, consider rerouting the highway.

Location Selection and Orientation Guidelines

Bridge location and orientation requirements are covered in general in the [Bridge Project Development Manual](#). The specific hydraulic requirements are covered below:

- ◆ The bridge should be centered on the main channel portion of the entire floodplain. This may mean an eccentricity in the location with respect to the entire stream cross section, but allows for better accommodation of the usual and low flows of the stream.
- ◆ The bridge waterway opening should be designed to provide a flow area sufficient to maintain the through-bridge velocity for the design discharge no greater than the allowable through-bridge velocity.
- ◆ The headers and interior bents should be oriented to conform to the streamlines at flood stage. Standard skew values of 15°, 30°, and 45° should be used where feasible. The piers and the toe of slope of the header must be located away from deep channels, cuts, and high velocity areas to avoid scour problems or interference with stream low flows.
- ◆ Consider including either relief openings or guide banks if the intrusion of either or both roadway headers into the stream floodplains is more than about 800-feet.
- ◆ Existing vegetation should be incorporated into the overall bridge plan. Where practicable, trees and shrubs should be left intact even within the right-of-way. Minimizing vegetation removal also tends to control turbulence of the flow into, through, and out of the bridge.
- ◆ For some configurations, roadway approaches may need to accommodate overflow. Such overflow approaches allow floods that exceed the design flow to overtop the roadway, thereby reducing the threat to the bridge structure itself. Protection of the approaches from overflow damage should be considered.

Environmental Considerations

Environmental impacts must be considered along with the hydraulic issues as one may directly affect the other. (See the [Environmental Manual](#) for details.)

Biological considerations in site selection include the effects on habitat and ecosystems in the floodplain, stream, and associated wetlands. Biologists should assess this aspect of site selection, but provide much of the information necessary for a valid assessment of the biological effects and the available alternatives for mitigation, including the following:

- ◆ economic viability of using a bridge rather than filling in wetland areas
- ◆ cost to replace lost marsh or wetland areas
- ◆ circulation of fresh or brackish water in marshes and estuaries
- ◆ feasibility of providing mitigating measures for the loss of invertebrate population
- ◆ shade and resting areas for fish.

Water Resource Development Projects

Water resources development projects such as reservoirs or stream channel modifications, whether existing or only potentially planned, must be considered when selecting a stream crossing location. Planned resources development projects often require the relocation or reconstruction of existing highways and can interfere with the location or design of proposed highway-stream crossings. Many water resources development projects are planned or authorized for periods of years or even decades before construction begins. Others never come to fruition or may be permanently stopped by court decisions or regulatory agency actions.

The roadway designer must carefully plan and construct a highway facility near a water resources project location, designing the highway facility for both existing and future site conditions. The excess cost of building the facility due to the water resources project must be considered in selecting the stream-crossing site. See Chapter 12, [Reservoirs](#).

FEMA Designated Floodplains

The majority of highway crossings involve floodplains that are in FEMA-participating communities. It is important to acknowledge FEMA floodplains in the planning phases of a project and accommodate them in design. Early coordination with the community's NFIP administrator is essential to identify and avert potential problems. See Chapter 5, [Federal Emergency Management Agency \(FEMA\) National Flood Insurance Program \(NFIP\) Compliant Design of Floodplain Encroachments and Minor Structures](#).

Stream Characteristics

All streams change with time. Planning, roadway and bridge design engineers should be conscious of stream morphology and be aware that methods are available for quantifying natural changes and changes that can occur as the result of stream encroachments and crossings. See Chapter 7, [Channels](#).

Procedure to Check Present Adequacy of Methods Used

Methods to analyze the hydrology and hydraulics at bridge sites continue to improve. In many cases, a method used in the original analysis is no longer an appropriate method. The following steps should be used to examine the adequacy of the method:

1. Examine the adequacy of the analysis for the original crossing design before undertaking major reconstruction or replacement.
2. If the method originally used is no longer appropriate, recalculate the analysis for these crossings using an appropriate one.
3. Reconsider the risk of failure of the existing structure, including the following:
 - increased traffic volumes
 - changed traffic service requirements
 - increased highway construction and maintenance costs
 - liability for damages to property that could be attributed to the highway crossing.

Section 3 — Bridge Hydraulic Considerations

Bridge/Culvert Determination

The first step in analysis for a cross-drainage facility is the establishment of the flood frequency curve and the stage-discharge curve according to Chapter 4, [Hydrology Study Requirements](#), and Chapter 6, [Open Channel Flow](#); and the second step is to make a decision concerning the type of cross-drainage structure. All types of facilities should be appraised based on performance and economics. The choice is usually between a bridge and culvert. If the stream crossing is wide with multiple concentrations of flow, a multiple opening facility may be in order.

At many locations, either a bridge or a culvert will fulfill both the structural and hydraulic requirements for the stream crossing. The roadway designer should choose the appropriate structure based on the following criteria:

- ◆ construction and maintenance costs
- ◆ risk of failure
- ◆ risk of property damage
- ◆ traffic safety
- ◆ environmental and aesthetic considerations
- ◆ construction expedience.

Although the cost of an individual bridge is usually relatively small, the total cost of bridge construction constitutes a substantial share of the total cost of highway construction. Similarly, bridge maintenance may account for a large share of the total cost of maintaining highway hydraulic features. The roadway designer can achieve improved traffic service and reduced cost by judicious choice of design criteria and careful attention to the hydraulic design of each bridge.

Highway-Stream Crossing Analysis

The hydraulic analysis of a highway-stream crossing for a particular flood frequency involves the following:

- ◆ determination of the backwater associated with each alternative profile and waterway opening(s)
- ◆ determination of the effects on flow distribution and velocities
- ◆ estimation of scour potential.

The hydraulic design of a bridge over a waterway involves the following such that the risks associated with backwater and increased velocities are not excessive:

- ◆ establishing a location
- ◆ bridge length
- ◆ orientation
- ◆ roadway and bridge profiles.

A hydrologic and hydraulic analysis is required for designing all new bridges over waterways, bridge widening, bridge replacement, and roadway profile modifications that may adversely affect the floodplain even if no structural modifications are necessary. Typically, this should include the following:

- ◆ an estimate of peak discharge (sometimes complete runoff hydrographs)
- ◆ existing and proposed condition water surface profiles for design and check flood conditions
- ◆ consideration of the potential for stream stability problems and scour potential.

See the [Documentation Reference Tables](#) in Chapter 3 for a complete list of requirements.

Flow through Bridges

When flood flows encounter a restriction in the natural stream, adjustments take place in the vicinity of the restriction. The portion of flow not directly approaching the bridge opening is redirected towards the opening by the embankment. The flow contracts as it enters the bridge and then expands as it exits the bridge. Maintaining the contraction and expansion of flow and overcoming friction and disturbances associated with piers and abutments requires an exchange of energy. An increase in the depth of flow upstream of the encroachment, termed backwater, reflects this energy exchange, as shown in Figure 9-1.

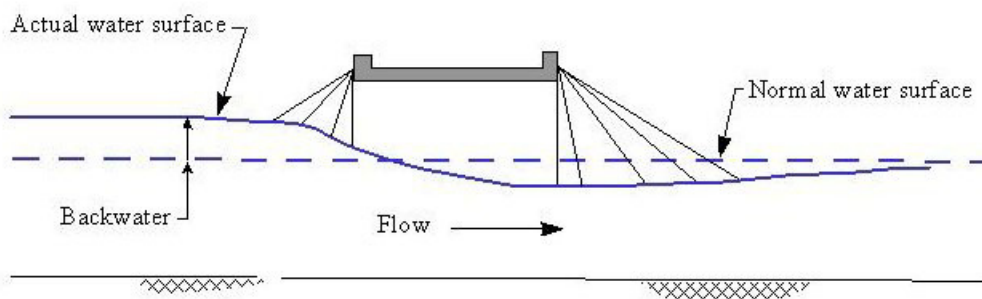

Figure 9-1. Backwater at a Stream Crossing

Backwater in Subcritical Flow

In subcritical flow conditions, the backwater tails off upstream until it reaches the normal water surface. The distance upstream over which backwater occurs depends on the channel conditions

and flow conditions (see the [Standard Step Procedure](#) in Chapter 7). The maximum backwater tends to occur in an arc around the opening as Figure 9-2 shows. The relatively steep water surface gradient between the maximum backwater and the opening is termed the drawdown area.

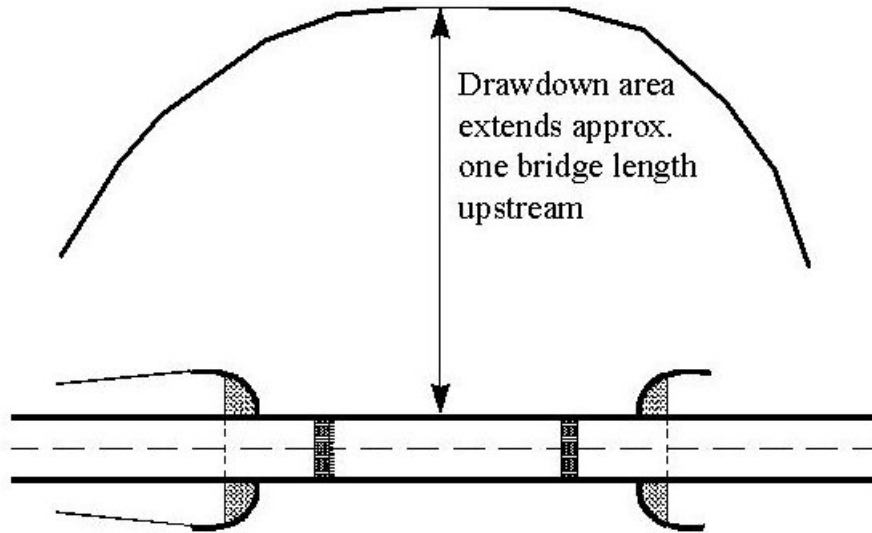

Figure 9-2. Extent of Backwater Drawdown

In a stream channel with supercritical flow conditions a constriction such as a bridge may not affect the upstream flow conditions. However, if the constriction is severe enough, it could cause a change in flow regime such that a backwater occurs upstream of the bridge and a hydraulic jump occurs near the bridge.

As the flow becomes constricted as it moves toward the bridge opening, the velocity increases, which can result in scour along the embankment and through the bridge. At the bridge headers, intersecting velocity vectors can cause severe turbulence and eddies as shown in Figure 9-3. Piers in the waterway create additional local turbulence and vortices. Turbulence, eddying, and vortices often result in scour.

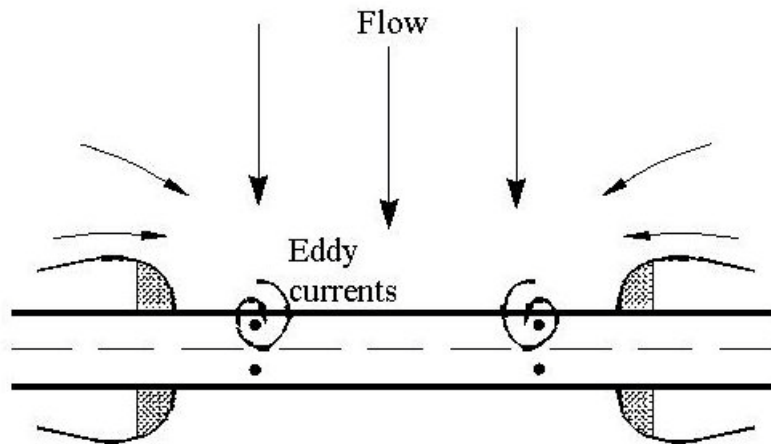

Figure 9-3. Typical Eddy Currents through Bridge Opening

Allowable Backwater Due to Bridges

For design frequency conditions, the allowable backwater should be established based on the risk of incurring flood-related damage to the highway and adjacent property. See Chapter 3 for discussion on [Evaluation of Risk](#) assessment. The allowable backwater should also consider the presence of FEMA mapped floodplains. See [Chapter 5](#), for a more thorough explanation on the FEMA NFIP requirements.

Flow Distribution

Any stream crossing that uses a combination of fill and bridge within the floodplain disturbs flow distribution during some floods. However, the normal flow distribution should be preserved to the extent practicable in order to:

- ◆ avoid disruption of the stream-side environment
- ◆ preserve local drainage patterns
- ◆ minimize damage to property by either excessive backwater or high local velocities
- ◆ avoid concentrating flow areas that were not subjected to concentrated flow prior to construction of the highway facility
- ◆ avoid diversions for long distances along the roadway embankment.

Generally, the disturbance of flow distribution can be minimized by locating bridge openings at the areas of high conveyance.

For many situations, one-dimensional analysis techniques suffice for determining optimum bridge locations. When analyzing complex sites, such as those at a bend (Figure 9-4), and at skewed crossings (Figure 9-9), a great deal of intuition, experience, and engineering judgment are needed to

supplement the one-dimensional analysis. Unfortunately, complex sites are frequently encountered in stream crossing design. The development of two-dimensional techniques of analysis greatly enhances the capabilities of hydraulics designers to deal with these complex sites. However, two-dimensional models required a great deal more data, intuition, experience and time than a one-dimensional model.

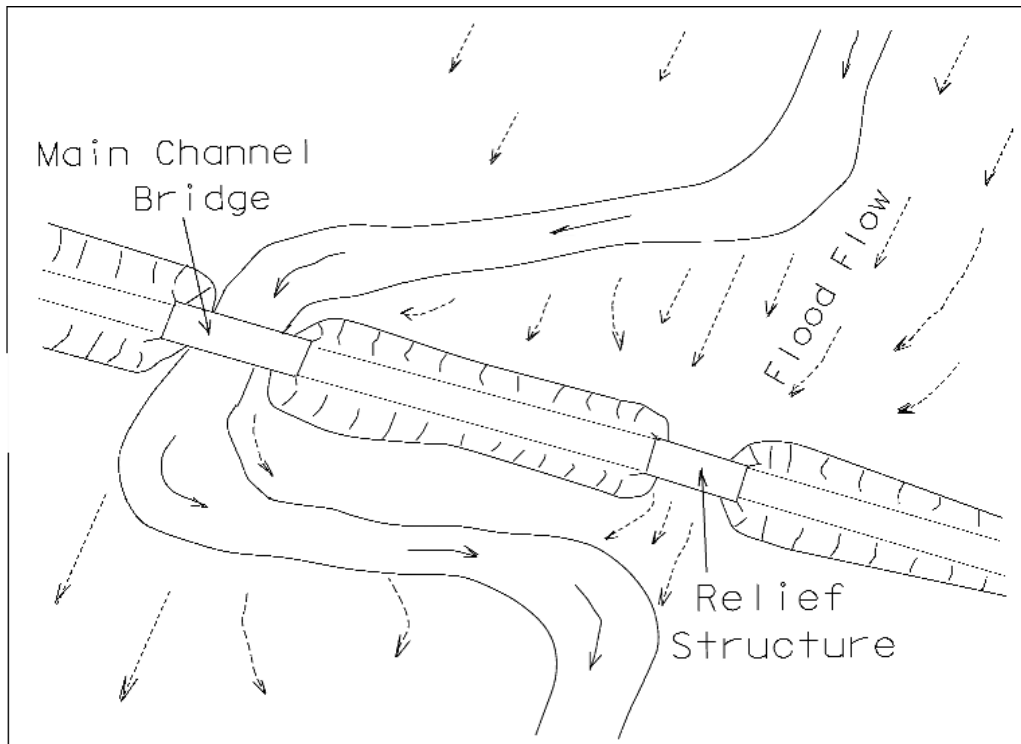

Figure 9-4. Highway Stream Crossing at a Bend

Velocity

While some bridge openings may have a relatively uniform velocity across the entire bridge opening, in most instances there are wide variations in the velocity profile. In some segments of the flow (e.g., near the center of the stream), the velocity may be considerably higher than the average velocity. In areas of shallow flow, the velocity may be quite low. The velocity profile may even include negative velocities (reverse flows). Figure 9-5 shows an example of a velocity profile through a bridge opening.

The through-bridge velocity is the basic sizing criterion used for span-type bridges. The average through-bridge velocity is described by the Continuity Equation (see Equation 9-1).

$$V = \frac{Q}{A}$$

Equation 9-1.

where:

V = average velocity (fps or m/s)

A = Normal cross-sectional area of the water (sq.ft. or m^2)

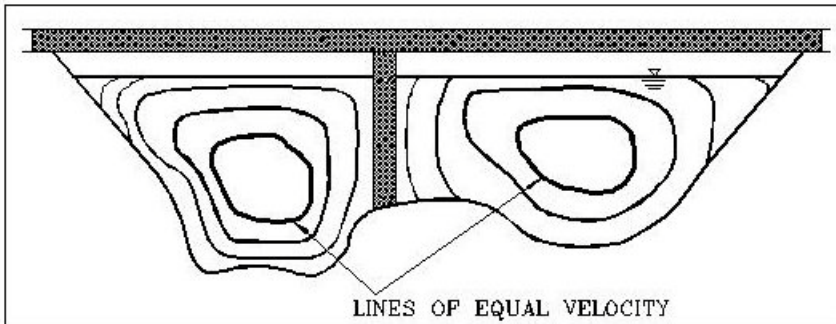

Figure 9-5. Velocity Profile Through Bridge Opening (heavier lines = higher velocity)

In general, waterway velocities should replicate the velocity of the natural channel. Higher velocities may be acceptable in certain cases where the streambed is rocky or the bridge headers are sufficiently removed from the erosive effects of floodwaters.

Bridge Scour and Stream Degradation

A scour analysis is required for new bridges, replacements, and widenings. Where a scour analysis indicates high depths of potential contraction scour, a structure larger than that required by the basic velocity and backwater criteria may be more cost effective than to designing foundations and armoring to withstand the scour. The potential for deep local scour can be reduced by enlarging the structure, but designing foundations and armoring to withstand local scour depths may be more cost-effective. Generally, a multi-disciplined team should assess the validity of calculated scour depths.

Stream stability issues such as potential vertical and horizontal degradation may warrant accommodations in the bridge design. If the channel is vertically degrading, it is likely that, as the channel deepens, the banks will slough resulting in a widening. Also, where significant meandering is occurring, meanders tend to migrate downstream and increase in amplitude. Structural options to accommodate either of these cases can include longer structures with deep enough foundations to accommodate anticipated degradation or deep enough foundations with abutment foundations designed to act as interior bents to allow future lengthening of the bridge.

Refer to the [Geotechnical Manual](#) and the Bridge Division Geotechnical Section for further information on bridge scour calculations and protection and for stream stability issues.

Freeboard

Navigational clearance and other reasons notwithstanding, the low chord elevation is established as the sum of the design normal water surface elevation (high water) and a freeboard.

For on-system bridges, the department recommends a suitable freeboard based on the flowing criteria:

- ◆ Higher freeboards may be appropriate for bridges over streams that are prone to heavy debris loads, such as large tree limbs, and to accommodate other clearance needs.
- ◆ Lower freeboards may be desirable, because of constraints such as approach geometry. However, the design high water must not impinge on the low chord.

Generally, for off-system bridge replacement structures, the low chord should approximate that of the structure to be replaced unless the results of a risk assessment indicate a different structure is the most beneficial option.

Roadway/Bridge Profile

The bridge is integrated into both the stream and the roadway and must be fully compatible with both. Therefore, the alignment of the roadway and the bridge are the same between the ends of the bridge. Hydraulically, the complete bridge profile includes any part of the structure that stream flow can strike or impact in its movement downstream. If the stream rises high enough to inundate the structure, then the bridge and all parts of the roadway become the complete bridge profile.

It is not allowable for the design AEP flow to impinge on the bridge low chord or to inundate the roadway because it violates the definition of design frequency. However, flows exceeding the design AEP flow, including the 1% AEP flow, may inundate the structure and roadway. Unless the route is an emergency escape route, it is often desirable to allow floods in excess of the design flood to overtop the road. This helps minimize both the backwater and the required length of structure.

Several vertical alignment alternatives are available for consideration, depending on site topography, traffic requirements, and flood damage potential. The alternatives range from crossings that are designed to overtop frequently to crossings that are designed to rarely or to never overtop.

In Figure 9-6, the bridge is at the low point in a sag-vertical curve profile. An extreme example of this configuration is a bridge in rolling terrain on a low-traffic road which frequently overtop. Another example is a high bridge in rugged terrain that probably will never be threatened by floods. A distinctive feature of the sag-vertical profile is the certainty that the bridge structure will be submerged when any overflow of the roadway occurs.

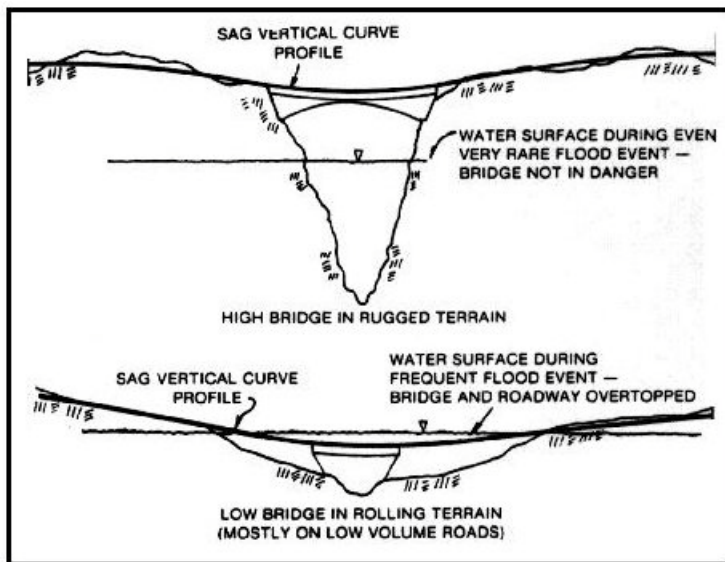

Figure 9-6. Sag-Vertical Curves

If accumulation of drift in the superstructure is likely, placement of bridges on sag-vertical curves should be avoided. Trapped debris can increase the potential for scour by creating eddies and turbulence. The accumulation of debris on the structure can also increase the effective depth of the superstructure, which would impose larger hydraulic forces on the superstructure and possibly cause structural failure, especially if scour has affected the foundations.

If a sag-vertical curve design has even a small probability of overtopping, open-type railing should be used and the use of curbs should be avoided to minimize damage from high velocity flow around the ends of the parapets.

Figure 9-7 illustrates a profile that may be used where the valley width is sufficient for a crest profile that allows the roadway to be overtopped without submerging the bridge superstructure. Use variations of this profile in locations where the stream channel is located on one side of the floodplain (i.e., an eccentric crossing) and the profile allows overtopping of the approach roadway only on one side. However, perching the structure any higher than required for freeboard offers no economic or hydraulic advantage unless other clearance requirements control the vertical position of the structure.

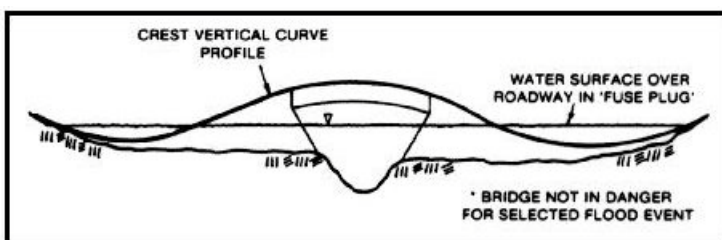

Figure 9-7. Crest Vertical Curve

You can vary the difference between the lowchord and the design water surface elevation, within geometric constraints, to meet requirements for maintaining free surface flow and to accommodate passage of debris and drift. However, perching the structure any higher than required for freeboard offers no economic or hydraulic advantage unless other clearance requirements control the vertical position of the structure.

Figure 9-8 illustrates a profile alternative. Variations of the level profile include a slight crest vertical curve on the bridge to establish a camber in the superstructure. With this profile, all floods with stages below the profile elevation of the roadway and bridge deck will pass through the waterway opening provided.

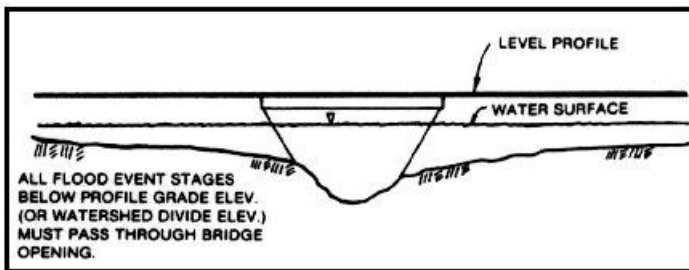

Figure 9-8. Level or Slight Crest Vertical Curve

The disadvantages of the near level profile are similar to those of a sag profile. With either profile configuration, severe contraction scour is likely to occur under the bridge and for a short distance downstream when the superstructure is partially or totally submerged.

Because no relief from these forces is afforded, crossings on zero gradients and in sag-vertical curves are more vulnerable than those with profiles that provide an alternative to forcing all water through the bridge waterway.

Crossing Profile

The horizontal alignment of a highway at a stream crossing should be considered in selecting the design and location of the waterway opening, as well as the crossing profile. Every effort should be made to align the highway so that the crossing will be normal to the stream flow direction (highway centerline perpendicular to the streamline). Often, this is not possible because of the highway or stream configuration.

When a skewed structure is necessary, such as appears in Figure 9-9, the substructure fixtures such as foundations, columns, piers, and bent caps must be designed to offer minimum resistance to the stream flow at flood stage. The channel may meander within the floodplain and cross under the roadway at an angle different from the floodplain. The bents and headers should be aligned to the stream flow at flood stage because most damage to the bridge happens at flood stage. Flood stage flows also carry the most amount of debris. Bents not aligned with the flood flow will become an obstruction to the flood flow and increase the risk of scour or other failure. The standard skew

angles, 15°, 30°, and 45° should be used unless the flow volume or some other problem renders them impractical.

In spite of the flood flow orientation, bents should not be located in the low flow channel if at all possible. As the flow is most concentrated in the channel, the piers would be subject to the highest hydraulic forces. The placement would also increase risk of scour by creating eddies and turbulence, and may encourage drift buildup.

Additionally, relief openings should be provided at the approximate location of point A in Figure 9-9 to reduce the likelihood of trapped flow and to minimize the amount of flow that would have to travel up against the general direction of flow along the embankment.

With the configuration shown in Figure 9-9, the difference in water surface on either side of the embankment at points A and B will be higher than water surface differential through the opening. Relief openings at A and B will help minimize the differential.

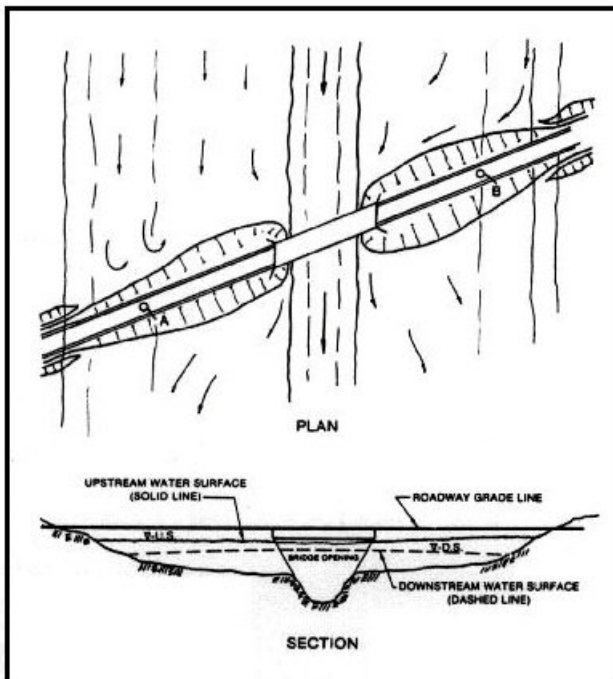

Figure 9-9. Skewed Stream Crossing and Water Surface Differentials

Single versus Multiple Openings

For a single structure, the flow will find its way to the opening until the roadway is overtopped. If two or more structures are available, the flow will divide and proceed to the structures offering the least resistance. The point of division is called a stagnation point.

In usual practice, TxDOT recommends that the flood discharge be forced to flow parallel to the highway embankment for no more than about 800 ft. If flow distances along the embankment are

greater than recommended, a relief structure that will provide an additional opening is recommended. A possible alternative to the provision of an additional structure is a [guide bank \(spur dike\)](#) to control the turbulence at the header as discussed in Section 7.

Natural vegetation between the toe of slope and the right-of-way line is useful in controlling flow along the embankment. Therefore, make special efforts to preserve any natural vegetation in such a situation.

Factors Affecting Bridge Length

Bridges over waterways are not always limited to the length of the hydraulic opening required.

- ◆ The roadway alignment is at a skew to the streambed, and normalizing the alignment would require unsafe or undesirable curves on the approaches to the bridge.
- ◆ Embankments may be limited to a certain location due to local soil instability or permitting requirements.
- ◆ Bridge costs might be cheaper than embankment costs.
- ◆ Matching the highway profile grade line.
- ◆ High potential for a meander to migrate, or other channel instabilities.

These and other aspects are valid considerations that affect bridge waterway openings. However, hydraulic computations are necessary to predict the performance and operation of the waterway opening at flood stages. Do not neglect hydraulic design. The design decisions, including the reasons for any excess opening, must be documented.

Section 4 — Hydraulics of Bridge Openings

Bridge Modeling Philosophy

Numerous methods exist for estimating the hydraulic impact of bridge openings on water surface profiles. TxDOT recommends that computer programs be employed to perform such estimates. Generally, the documentation of the specific computer program should be referred to for the theory employed.

Note. Previously, TxDOT employed a single energy loss equation, ($h = \Delta v^2/2g$), to estimate the backwater effect of bridge openings. It is no longer used as the basis for design of TxDOT bridges.

Bridge Alignment

The discussions of bridge design assume normal lengths and alignments perpendicular to the flow at flood stage even though the low flow streambed may be at a skew to the bridge. In actuality, many bridges are skewed to some degree which causes the hydraulic length of the bridge to be longer than the plan width. For example, a 60-foot wide bridge perpendicular to the stream has a hydraulic length of 60 feet. The same bridge at a 30° skew to the stream has a hydraulic length of 69.3 feet.

Hydraulic programs do not automatically account for the skew. The program operator is required to specifically account for the skew by putting in the correct hydraulic length.

Flow Zones and Energy Losses

Figure 9-10 shows a plan of typical cross section locations that establish three flow zones that should be considered when estimating the effects of bridge openings.

NOTE: These cross sections are related to the explanation of flow zones and energy losses and must not be confused with the cross sections required for analysis. The analysis cross sections may be further upstream and downstream.

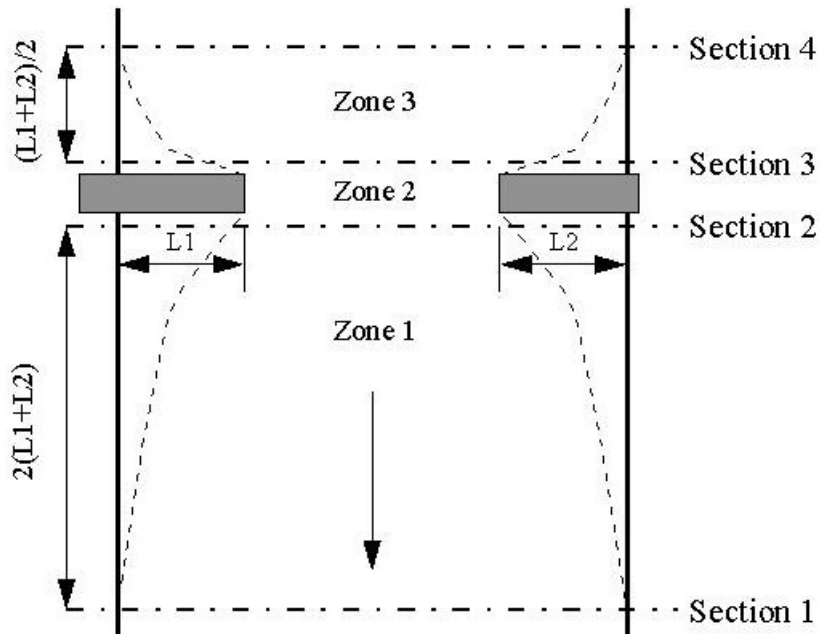

Figure 9-10. Flow Zones at Bridge

Zone 1 – Downstream. Zone 1 represents the area between the downstream face of the bridge and a cross section downstream of the bridge within which expansion of flow from the bridge is expected to occur. The distance over which this expansion occurs can vary depending on the flow rate and the floodplain characteristics. No detailed guidance is available, but a distance equal to about four times the length of the average embankment constriction is reasonable for most situations. Section 1 represents the effective channel flow geometry at the end of the expansion zone, which is also called the “exit” section. Cross sections 2 and 3 are at the toe of roadway embankment and represent the portion of unconstricted channel geometry that approximates the effective flow areas near the bridge opening as shown in Figure 9-11.

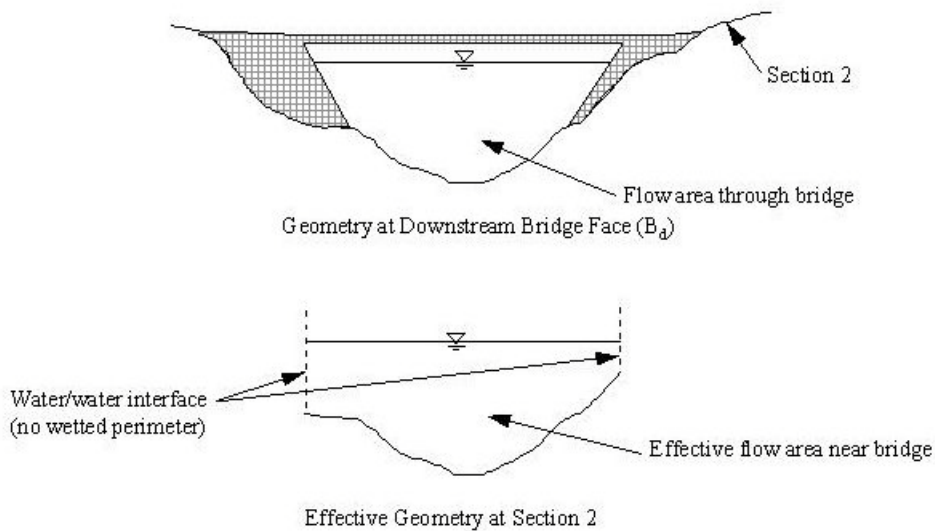

Figure 9-11. Effective Geometry for Bridge (Section 2 shown, Section 3 similar)

Zone 2 - Under Bridge Opening. Zone 2 represents the area under the bridge opening through which friction, turbulence, and drag losses are considered. Generally, consider the bridge opening by superimposing the bridge geometry on cross sections 2 and 3.

Zone 3 – Upstream. Zone 3 represents an area from the upstream face of the bridge to a distance upstream where contraction of flow must occur. A distance upstream of the bridge equal to the length of the average embankment constriction is a reasonable approximation of the location at which contraction begins. Cross section 4 represents the effective channel flow geometry where contraction begins. This is sometimes referred to as the “approach” cross section.

Extent of Impact Determination

The maximum effect of the bridge should occur at cross section 4. However, in order to determine the extent of the impact, continue water surface profile computations upstream until the water surface does not differ significantly from the estimated pre-construction conditions.

Water Surface Profile Calculations

Calculate the water surface profile through Zones 1 and 3 using the [Standard Step Backwater Method](#) (see Chapter 7) with consideration of expansion and contraction losses. The table 9-1 below provides recommended loss coefficients.

Table 9-1: Recommended Loss Coefficients for Bridges

Transition Type	Contraction (K_c)	Expansion (K_e)
No losses computed	0.0	0.0
Gradual transition	0.1	0.3

Table 9-1: Recommended Loss Coefficients for Bridges

Transition Type	Contraction (K_c)	Expansion (K_e)
Typical bridge	0.3	0.5
Severe transition	0.6	0.8

Bridge Flow Class

The losses associated with flow through bridges depend on the hydraulic conditions of low or high flow.

Low flow describes hydraulic conditions in which the water surface between Zones 1, 2, and 3 is open to atmospheric pressure. That means the water surface does not impinge upon the superstructure. (This condition should exist for the design frequency of all new on-system bridges.) Low flow is divided into categories as described in Table 9-2 “Low Flow Classes”. Type I is the most common in Texas, although severe constrictions compared to the flow conditions could result in Types IIA and IIB. Type III is likely to be limited to steep hills and mountainous regions.

Table 9-2: Low Flow Classes

Type Designation	Description
I	Subcritical flow through Zones
IIA	Subcritical flow Zones 1 and 3, flow through critical depth Zone 2
IIB	Subcritical Zone 3, flow through critical Zone 2, hydraulic jump Zone 1
III	Supercritical flow through Zones 1, 2 and 3

High flow refers to conditions in which the water surface impinges on the bridge superstructure:

- ◆ When the tailwater does not submerge the lowchord of the bridge, the flow condition is comparable to a pressure flow sluice gate.
- ◆ At the tailwater, which submerges the lowchord but does not exceed the elevation of critical depth over the road, the flow condition is comparable to orifice flow.
- ◆ If the tailwater overtops the roadway, neither sluice gate flow nor orifice flow is reasonable, and the flow is either weir flow or open flow.

Zone 2 Loss Methods

Generally determine the losses in Zone 2 by one of the following methods depending on the flow characteristics and the engineer's judgment:

- ◆ [Standard Step Backwater Method](#) (based on balance of energy principle)
- ◆ [Momentum Balance Method](#)

- ◆ [WSPRO Contraction Loss Method](#) [This is a method, not limited to the WSPRO program.]
- ◆ [Pressure Flow Method](#)
- ◆ [Empirical Energy Loss Method \(HDS 1\)](#).

Standard Step Backwater Method (used for Energy Balance Method computations)

Refer to Chapter 7 for the [Standard Step Backwater Method](#). Figure 9-12 shows the relative location of section geometry for profile computations. B_d and B_u refer to the bridge geometry at the downstream and upstream inside faces, respectively.

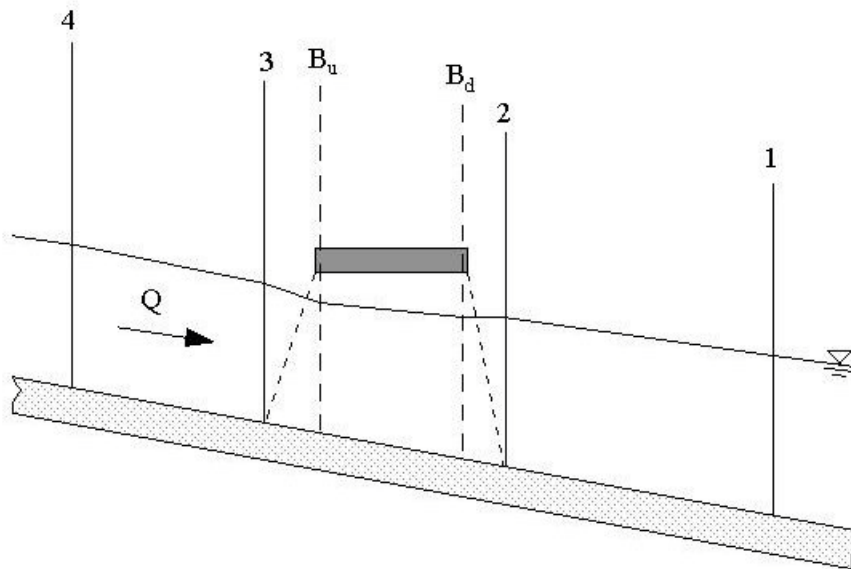

Figure 9-12. Relative Location of Section Geometry

1. Solve the energy equation (step backwater) between cross section 2 and the downstream bridge face (B_d). Use the water surface at cross section 2 determined from the previous backwater profile computations.
2. Proceed with the standard step backwater calculations from the downstream bridge face to the upstream face. Use the bridge geometry superimposed on cross sections 2 and 3 respectively.
3. Approximate the effects of piers and impingement of flow on the lowchord by reducing the section area and increasing the wetted perimeter accordingly.
4. Similarly, consider roadway overflow as open channel flow. Proceed with calculations from the upstream bridge face (B_u) to cross section 3.
5. As indicated in the previous [Flow Zones and Energy Losses](#) subsection, proceed with calculating the remainder of the bridge impact from cross section 3 upstream using step backwater calculations.

Under the right circumstances, you can consider the energy balance method for low flow and high flow.

Momentum Balance Method

This method computes the backwater through Zone 2 by balancing forces at three locations:

- ◆ between the inside, downstream face of the bridge (B_d) and cross section 2
- ◆ between the downstream and upstream ends of the bridge (B_d to B_u)
- ◆ between the inside, upstream face of the bridge (B_u) and cross section 3.

Refer to Figure 9-10 and Figure 9-12 for zone and cross section locations. Assuming hydrostatic pressure conditions, the forces acting on a control volume between two cross sections (1 and 2) must be in balance and are generalized in Equation 9-2.

$$F_{P2} + F_m = F_{P1} + F_f + F_d - F_w$$

Equation 9-2.

where:

F_{P1}, F_{P2} = force due to hydrostatic pressure at cross section = $\gamma A y$

F_m = force causing change in momentum between cross sections = $\rho Q \Delta v$

F_f = force due to friction = $\gamma(A_1 + A_2)LS_f/2$

F_d = total drag force due to obstructions (e.g., for piers = $\rho C_d A_o v^2/2$)

F_w = component of weight in direction of flow = $\gamma(A_1 + A_2)LS_o/2$.

1. For subcritical flow, determine the water surface elevation and average velocity at section 2 from step backwater computations.
2. Determine the water surface elevation and average velocity at Section B_d by applying successive assumed water surface elevations to Equation 9-3 until equality is achieved within a reasonable tolerance.
3. Determine the momentum correction factor (B), which accommodates natural velocity distributions similar to the energy correction factor, α , using Equation 9-4.
4. Using the resulting water surface elevation at B_d , determine the water surface elevation and average velocity at Section B_u by applying successive assumed water surface elevations at Section B_u to Equation 9-5 until achieving equality within a reasonable tolerance. B_u refers to the upstream face of the bridge.
5. Determine the final momentum balance between the upstream face of the bridge and cross section 3 using Equation 9-6. Table 9-3 “[Suggested Drag Coefficients for Bridge Piers](#)” presents suggested drag coefficients for different pier types.

6. As discussed in the above [Flow Zones and Energy Losses](#) section, proceed with the remainder of the bridge impact computations from cross section 3 upstream using step backwater calculations.

$$A_{Bd}\bar{y}_{Bd} + \frac{\beta_{Bd}Q^2}{gA_{Bd}} = A_2\bar{y}_2 - A_{pd}\bar{y}_{pd} + \frac{\beta_2Q^2}{gA_2} + \left(\frac{A_2 + A_{Bd}}{2}\right)LS_f - \left(\frac{A_2 + A_{Bd}}{2}\right)LS_o$$

Equation 9-3.

where:

Subscripts 2 and Bd refer to section 2 and the downstream bridge face, respectively.

A = effective flow area at cross sections (sq.ft. or m^2)

\bar{y} = height from water surface to centroid of effective flow area (ft. or m)

g = acceleration due to gravity (ft./s² or m/s²)

Q = discharge (cfs or m³/s)

A_{pd} = obstructed area of pier at downstream side (sq. ft. or m^2)

L = distance between cross sections (ft. or m)

S_f = friction slope (ft./ft. or m/m) (see Chapter 6)

S_o = channel bed slope (ft./ft. or m/m)

β = momentum correction factor.

$$\beta = \frac{A_T \sum [K_i^2 / A_i]}{K_T^2}$$

Equation 9-4.

where:

K_i = conveyance in subsection (cfs or m³/s)

A_i = area of subsection (sq. ft. or m^2)

K_T = total conveyance of effective area section (cfs or m³/s)

A_T = total effective area (sq.ft. or m^2).

$$A_{Bu}\bar{y}_{Bu} + \frac{\beta_{Bu}Q^2}{gA_{Bu}} = A_{Bd}\bar{y}_{Bd} + \frac{\beta_{Bd}Q^2}{gA_{Bd}} + \left(\frac{A_{Bd} + A_{Bu}}{2}\right)LS_f - \left(\frac{A_{Bd} + A_{Bu}}{2}\right)LS_o$$

Equation 9-5.

$$A_3\bar{y}_3 + \frac{\beta_3Q^2}{gA_3} = A_{Bu}\bar{y}_{Bu} + A_{pu}\bar{y}_{pu} + \frac{\beta_{Bu}Q^2}{gA_{Bu}} + \left(\frac{A_{Bu} + A_3}{2}\right)LS_f - \left(\frac{A_{Bu} + A_3}{2}\right)LS_o + \frac{C_d A_{pu} Q^2}{2gA_3^2}$$

Equation 9-6.

where:

Subscript 3 refers to cross section 3

A_{pu} = Obstructed area of piers at upstream side (sq.ft. or m²)

C_d = drag coefficient

Table 9-3: Suggested Drag Coefficients for Bridge Piers

Pier Type	Drag Coefficient, C_d
Circular	1.20
Elongated with semi-circular ends	1.33
Elliptical (2:1 aspect ratio)	0.60
Elliptical (4:1 aspect ratio)	0.32
Elliptical (8:1 aspect ratio)	0.29
Square nose	2.00
Triangular nose (30° apex)	1.00
Triangular nose (60° apex)	1.39
Triangular nose (90° apex)	1.60
Triangular nose (120° apex)	1.72

WSPRO Contraction Loss Method

The Water Surface Profile (WSPRO) method is a contraction model that uses step backwater calculations and empirical loss coefficients. *This method is not limited to the WSPRO program.*

1. Base the model on providing approach and exit cross sections (cross sections 1 and 4) at distances from the downstream and upstream faces approximately equal to the bridge opening length.
2. Compute the flow in Zones 1 and 3 using step backwater computations with a weighted flow length based on 20 equal conveyance tubes. Refer to *Bridge Waterways Analysis Model* (Shearman et al., 1986) for details on this method. (See [Reference](#) for details on obtaining this document.)

Pressure Flow Method

By definition, pressure flow methods represent high flow conditions. Figure 9-13 shows a high flow condition in which the water surface at the upstream face of the bridge has impinged the low-chord but the downstream face is not submerged. You may approximate this condition as a sluice gate using Equation 9-7. You need to assume successive elevations at cross section 3 (y_3) until the calculated discharge in Equation 9-7 is equal to the design discharge within a reasonable tolerance.

$$Q = CA_b \left[2g \left(y_3 - \frac{D_b}{2} + \frac{\alpha_3 v_3^2}{2g} \right) \right]^{0.5}$$

Equation 9-7.

where:

Q = calculated discharge (cfs or m³/s)

C = discharge coefficient (0.5 suggested)

A_b = net area under bridge (sq. ft. or m²)

y_3 = depth of flow at cross section 3 (ft. or m)

D_b = height of lowchord from mean stream bed elevation (ft. or m).

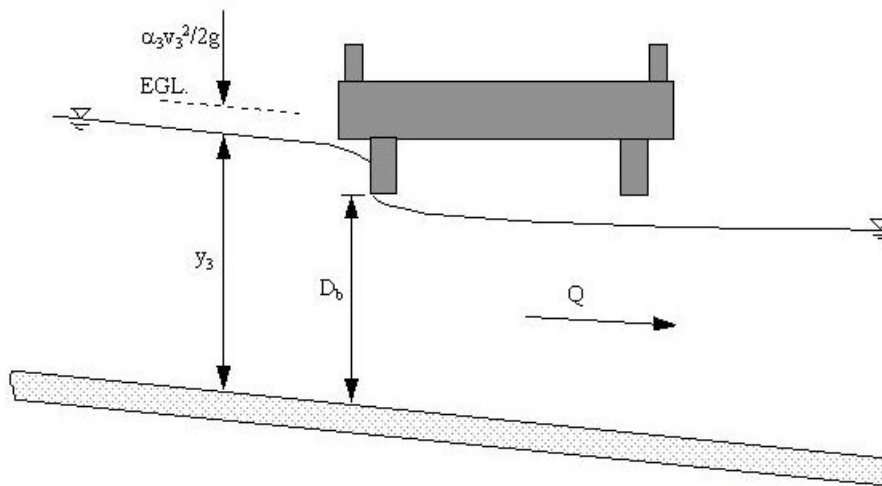

Figure 9-13. Sluice Gate Type Pressure Flow

Figure 9-14 shows a submerged bridge opening with a tailwater lower than the overtopping elevation. Equation 9-8 represents orifice flow. You need to assume successive elevations at cross section 3 (y_3) until the calculated discharge in Equation 9-8 is equal to the design discharge within a reasonable tolerance.

$$Q = CA_b \sqrt{2gH}$$

Equation 9-8.

where:

C = discharge coefficient (0.8 typical)

H = difference between energy grade at cross section 3 and water surface at cross section 2 (ft. or m), Equation 9-9.

$$H = y_3 + \alpha_3 \frac{v_3^2}{2g} - y_2$$

Equation 9-9.

where:

α_3 = kinetic energy correction coefficient

C_d = coefficient of discharge, Equation 9-12.

$$C_d = 0.104 \frac{L_c}{b} + 0.7145$$

Equation 9-10.

where:

b = width of top of embankment at bridge abutment (ft. or m) (see Figure 9-15)

L_c = length of bridge opening between abutment faces (ft. or m).

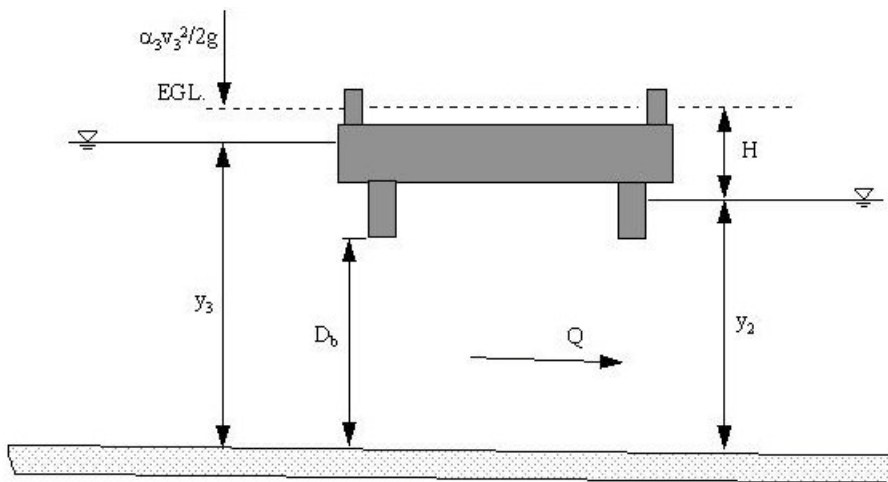

Figure 9-14. Orifice Type Pressure Flow

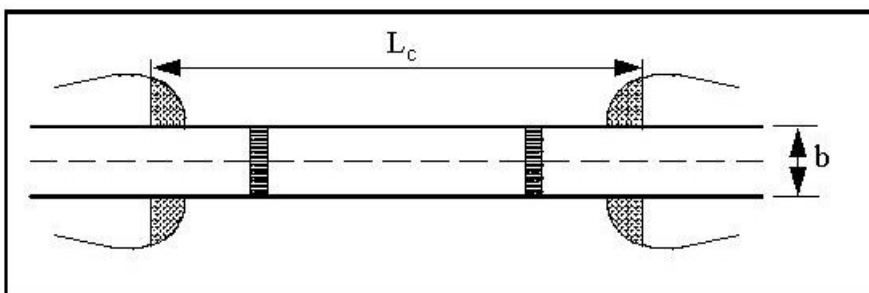

Figure 9-15. Bridge Dimensions for Pressure Flow Analysis

Empirical Energy Loss Method (HDS 1)

Although hand computations are used rarely, the FHWA publication *Hydraulics of Bridge Waterways* ([HDS 1](#)) presents methods for estimating bridge backwater effects. The HDS-1 [Empirical Loss Method](#) presents a summary of the method that is appropriate for low flow Type I. (This flow type should predominate for the design of bridges over Texas streams.)

Two-dimensional Techniques

Two-dimensional (2-D) horizontal flow, depth-averaged techniques are highly specialized. Contact the Design Division's Hydraulics Branch for consultation.

Roadway/Bridge Overflow Calculations

Consider flow over the bridge or roadway in one of two ways:

- ◆ Weir flow if the tailwater does not drown out critical depth of flow in the overtopping section - the approach is similar to that in the [Roadway Overtopping](#) subsection of Chapter 8, except that the design engineer must use the bridge loss methods above instead of culvert head loss computations. That is, apportion flow between the bridge and the weir such that the head at cross section 3 results in a flow apportionment that sums to equal the design flow within a reasonable tolerance.
- ◆ Open channel flow if the tailwater is too high -- As the depth of flow over the road increases and the tailwater submerges the road, the design engineer considers the flow over the road as open channel flow and use step backwater computations across the road.

Backwater Calculations for Parallel Bridges

The backwater calculation for parallel bridges (depicted in Figure 9-16) requires the application of a coefficient. The chart in Figure 9-17 relates the value of the backwater adjustment coefficient (μ) to the ratio of the out-to-out dimension of the parallel bridges to the width of a single embankment (see Figure 9-18). Determine the backwater head calculation for a parallel bridge with Equation 9-11.

$$h = \mu h_1$$

Equation 9-11.

where:

h = total backwater head (ft. or m)

μ = backwater adjustment coefficient (see Figure 9-17)

h_1 = backwater head for one bridge as discussed in the [Bridge Flow Class](#) subsection above.

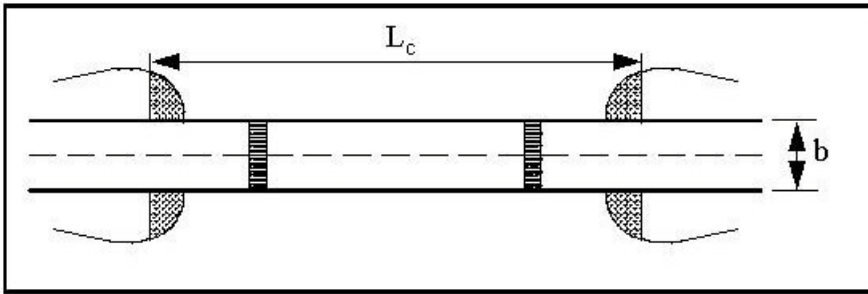

Figure 9-16. Parallel Bridges

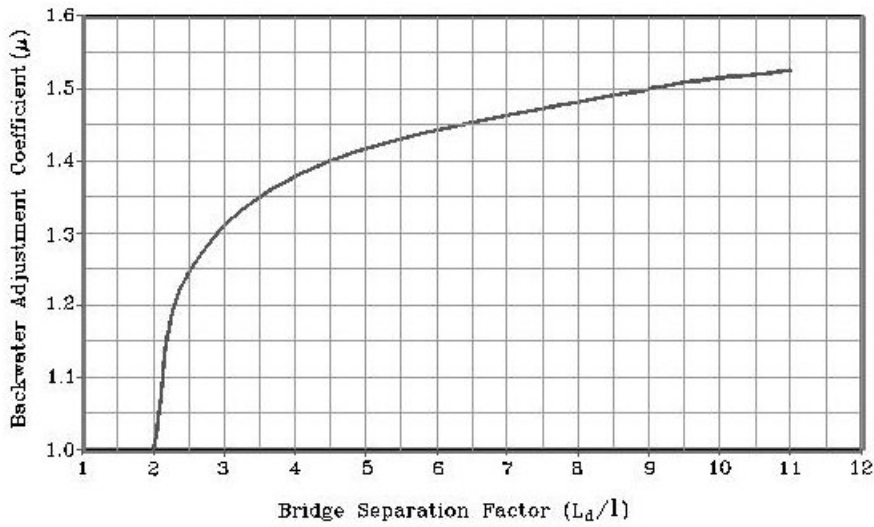

Figure 9-17. Parallel Bridges Backwater Adjustment

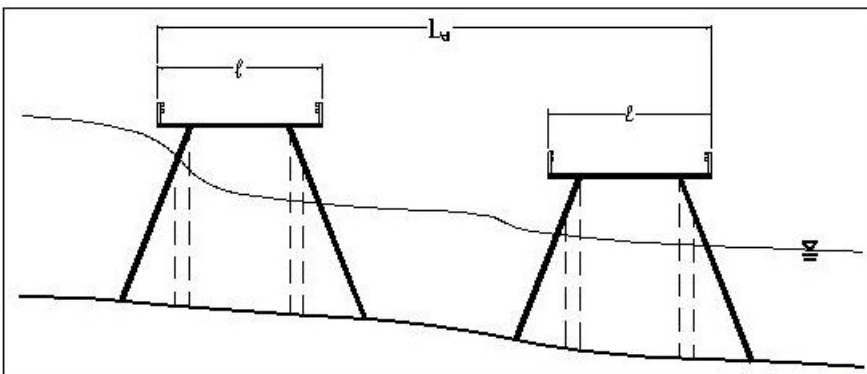

Figure 9-18. Definition of Parameters

Section 5 — Single and Multiple Opening Designs

Introduction

This section provides a means to establish an initial size of opening and lengths and locations of multiple openings.

- ◆ For a single opening, analyze the effect of the trial opening using the method selected from those outlined in [Bridge Hydraulic Considerations](#). If the resulting backwater or through-bridge velocities are unacceptable, modify the opening until the estimated conditions are satisfactory for both the design and check flood conditions. The department recommends automated procedures for such analyses.
- ◆ Where a bridge must cross a relatively wide floodplain or multiple discharge concentrations, it may be necessary to design multiple openings. A multiple opening configuration usually constitutes a main channel bridge with relief openings. This type of crossing provides openings at or near the flow concentrations. The result is a reduction in along-embankment flow and backwater effects.

Single Opening Design Guidelines

To establish a single structure length and elevation of lowchord, begin by estimating the design flood, obtaining accurate controlling cross sections, and determining the design and check flood water surface profiles. For complete documentation, you may need a compilation of past flood history, existing structures, and other highway crossing characteristics of the stream.

1. Assume an average through-bridge velocity (v_t) that is less than the maximum allowable velocity but that is not lower than the unconfined average velocity.
2. Apply the unconfined design water surface elevation to the cross section, and find the area (A_t) subtended by this water surface that will satisfy the Continuity Equation (Equation 9-1, reworked as Equation 9-12) for trial velocity and design discharge.

$$A_t = \frac{Q}{v_t}$$

Equation 9-12.

3. Estimate an average depth of water (D_t) in the cross section where the bridge is to be located by inspecting the section.
4. Find the trial length (L_t) of the bridge using Equation 9-13.

$$L_t = \frac{A_t}{D_t}$$

Equation 9-13.

5. Position the headers in the stream cross section (same cross section as in Step 3) so that they are approximately L_t apart and at locations that appear to maximize the through-bridge area.
6. Find the exact waterway area (A_w) below the design high water within the structure limits.
7. Find the average through-bridge velocity (v_b) for the actual waterway area (A_w) by using the Continuity Equation.

$$v_b = \frac{Q}{A_w}$$

Equation 9-14.

8. Evaluate and establish allowable maximum velocity based on individual site characteristics. If v_b is close to the target average velocity, the initial bridge length may be reasonable. You must usually adjust this length slightly to fit standard span length requirements. If v_b is much lower or greater than the allowable maximum velocity, adjust the length as necessary, repeating steps 6 and 7. Repeat this routine until the average through-bridge velocity is close to the target velocity. To minimize the cost of the structure, it is usually desirable to adjust the bridge length so that the design velocity is at or very near the maximum allowable velocity.
9. Establish a lowchord (as discussed in the [Freeboard](#) subsection of Section 3).
10. For the design and 1% AEP discharges, estimate the backwater caused by the constriction of the bridge opening. Use the procedures outlined in the [Bridge Hydraulic Considerations](#) section (Section 3). You may need to adjust the bridge length to ensure that the backwater effects are not excessive and comply with FEMA NFIP criteria, where applicable.
11. Determine the maximum potential scour envelope. The Bridge Division Geotechnical Branch is the office of primary responsibility for bridge scour. See the Bridge Division [Geotechnical Manual](#) or contact the Geotechnical Branch for bridge scour policies.

Multiple Opening Design Approach

Design multiple structures so that each structure's carrying capacity (or conveyance) is approximately the same as the predicted discharge approaching the structure. Poorly sized structures could result in a reapportionment of the approach discharges. Reapportionment of flow, in turn, may cause excessive backwaters, unacceptable along-embankment velocities, and excessive velocities through some structures.

In addition to striving for balance in proportion (discussed in the Carrying Capacity Guidelines subsection above), satisfy average through-bridge velocity requirements. Unfortunately, widely disparate through-bridge velocities cause uneven backwaters that will likely redistribute of flow,

upsetting the originally designed balance of structure conveyances. The goal is to balance conveyances and simultaneously try to assure that the resulting energy grade levels at the approach cross section (Section 4) are about the same for each bridge in the multiple opening facility. (See [Bridge Sizing and Energy Grade Levels](#) for more information.)

Multiple Bridge Design Procedural Flowchart

The flow chart for multiple bridge design (Figure 9-19) illustrates the steps and considerations recommended in TxDOT designs.

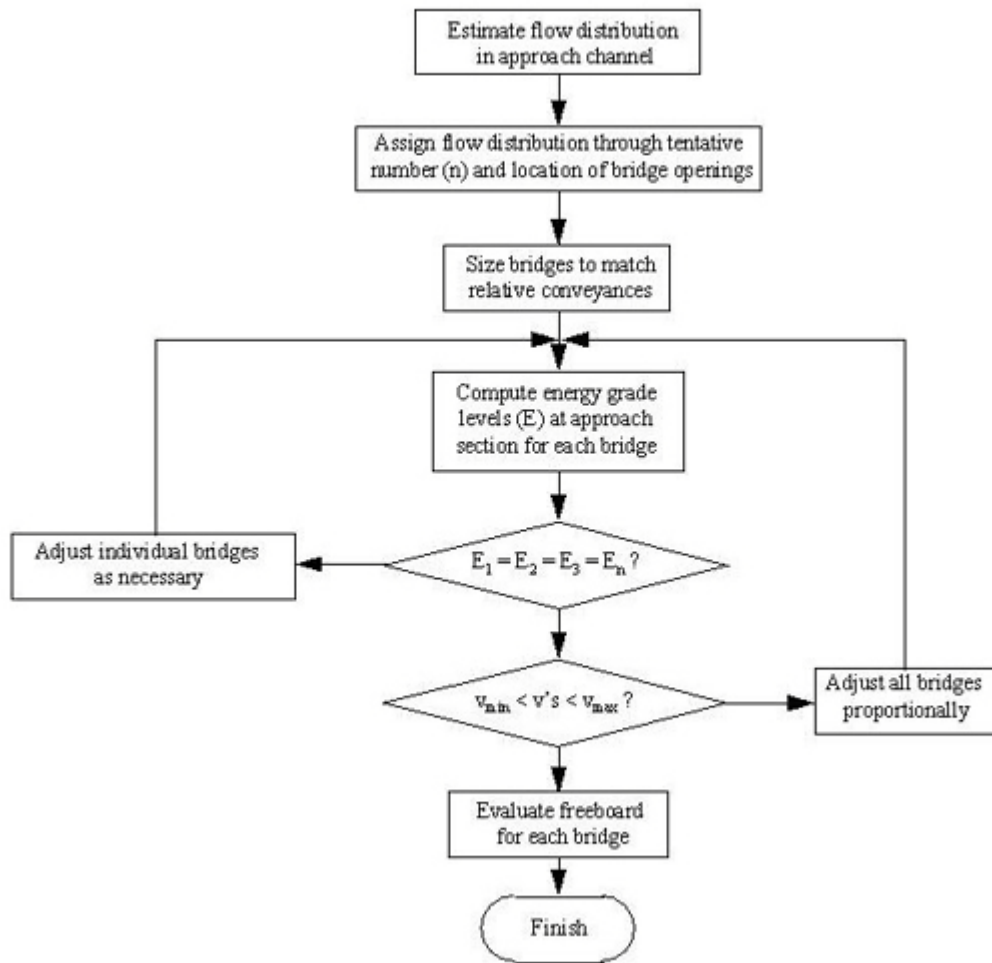

Figure 9-19. Multiple Bridge Design Flowchart

When estimating the design high water at a multiple structure location, the design engineer still needs to determine how the flow divides itself across the floodplain at flood stage. In the case of multiple structures, the flow division indicates the approximate portion of the total flood discharge that will be carried by each structure. One method for estimating flow division is by actually observing the flow at design discharge and design high water at the proposed site. However, the

ability to make such an observation when the proper set of circumstances occurs would be rare. Therefore, use the following analytical method to determine flow distribution and establish flow division.

Cumulative Conveyance Curve Construction

Inspection of incremental discharges or conveyances across a floodplain cross section usually reveals the location of relatively heavier concentrations of flow. By determining these heavier concentrations of flow, the design engineer can usually find reasonable locations for each of the bridges. In some instances, the concentrations of flow and associated flow divides are quite obvious. In other cases, the distribution of flow may be subtler, and must be estimated analytically, which is most easily done with a hydraulic analysis program.

Bridge Sizing and Energy Grade Levels

When you have estimated relative approach discharges, you should have two, often contradictory objectives:

- ◆ Try to size the multiple structures so that they offer approximately the same relative carrying capacities as the relative flow distribution would indicate.
- ◆ To minimize cross flow, you need to obtain similar values of energy grade level at the approach section for all openings. Generally, if the relative velocity differentials are not approximately the same for all openings, head differentials develop, causing a redistribution of the approach flows.

Often, it is not possible to balance energy grade levels and conveyances simultaneously. Therefore, because of the importance of avoiding a redistribution of flow from natural conditions, place more emphasis on balancing energy grade levels by having velocity head differentials approximately the same for each of the openings.

Size the bridges in a multiple opening situation to avoid exceeding maximum allowable through-bridge velocities at any of the openings. Calculate backwater head for a multiple opening situation in the same manner as for single opening structures outlined in the [Single Opening Design Procedure](#) subsection and based on the appropriate floodplain subsection and flow apportionment. That is, consider each bridge separately using the flow apportionment and associated portion of cross section.

Freeboard Evaluation

Determine the distance between the lowchord and the water surface. Then, compare the result to the recommended freeboard considerations discussed under [Freeboard](#) in Section 3.

Analysis of Existing Bridges

One-dimensional analysis of an existing bridge involves the same concepts employed for designing a new bridge: assume that the flood flow will distribute itself to attain a constant energy grade at the approach section. The existing bridge will likely redistribute flow from what the approach channel conditions might otherwise imply. The stagnation points become functions of the bridge openings and the channel conditions. Until the computed energy levels at the approach section are approximately equal, you need considerable trial and error may be needed to adjust stagnation points, determine conveyance apportionment, and analyze each opening.

Section 6 — Flood Damage Prevention

Extent of Flood Damage Prevention Measures

The response of alluvial streams to floods is often unpredictable. Knowledge of the history of a stream and its response to floods is the best guide for determining the extent of flood damage prevention measures. When protection is needed, whether at the time of construction or at a later date, the cost of providing the control measures should be compared to the potential costs associated with flood damage without the prevention measures.

Flood-related damage results from a variety of factors including the following:

- ◆ scour around piers and abutments
- ◆ erosion along toe of highway embankment due to along-embankment flow
- ◆ erosion of embankment due to overtopping flow
- ◆ long term vertical degradation of stream bed
- ◆ horizontal migration of stream banks
- ◆ debris impact on structure
- ◆ clogging due to debris causing redirection of flow.

The designer should assess the potential for these and other conditions to occur and consider measures that reduce the potential for damage from flooding.

Pier Foundations

The primary flood-related concern at piers is the potential for scour. Two typical approaches are to design deep enough foundations to accommodate scour and to protect the streambed around the foundation to prevent or reduce the potential for scour.

Primary protection measures at piers include concrete riprap, stone protection, gabions, and grout-filled or sand/cement-filled bags. See FHWA IH-97-030, “Bridge Scour and Stream Instability Countermeasures” ([HEC-23](#)) for discussion on selection of measures.

The following should be considered the following to reduce the potential for pier scour:

- ◆ Reduce numbers of piers by increasing span lengths, especially where you expect large debris loads.
- ◆ Use bullet-nosed or circular-shaped piers.
- ◆ Use drilled shaft foundations.

- ◆ Align bents with flood flow to degree practicable.
- ◆ Increase bridge length to reduce through-bridge velocities.

Where there is a chance of submergence, a superstructure that is as slender as possible with open rails and no curb should be used.

Because of uncertainties in scour predictions, use extreme conservatism in foundation design. In other words, deeper foundations may be cheaper. The capital costs of providing a foundation secure against scour are usually small when compared to the risk costs of scour-related failure.

Approach Embankments

Embankments that encroach on floodplains are most commonly subjected to scour and erosion damage by overflow and by flow directed along the embankment to the waterway openings. Erosion can also occur on the downstream embankment due to turbulence and eddying as flow expands from the openings to the floodplain and due to overtopping flow.

The incidence of damage from flow along an approach embankment is probably highest in wooded floodplains where the right-of-way is cleared of all trees and where borrow areas are established upstream of the embankment. Damage to approach embankment is usually not severe, but scour at the abutments from the flow contraction may be significant if the abutment is not protected.

The potential for erosion along the toe of approach embankment can be minimized by avoiding extensive clearing of vegetation and avoiding the use of borrow areas in the adjacent floodplain. Embankment protection such as stone protection can be used, but stable vegetation on the embankment may suffice. Other measures that may be used are [riprap](#), pervious dikes of timber, or finger dikes of earthen material spaced along and normal to the approach fill to impede flow along the embankment.

The embankment may need to be protected if significant overtopping of the approach embankment is anticipated during the life of the crossing. The embankment can be protected with soil cement or revetments, rock, wire-enclosed rock, or concrete.

Preventive measures are also needed at some crossings to protect the embankment against wave action, especially at reservoirs. Riprap of durable, hard rock should be used at such locations. The top elevation of the rock required depends on storage and flood elevations in the reservoir and wave height computed using wind velocities and the reservoir fetch.

Abutments

Protective measures used at abutments consist of the following:

- ◆ riprap header slopes and deep toe walls (stone protection is generally preferred to concrete)

- ◆ vertical abutment walls
- ◆ sheet pile toe walls
- ◆ deep foundations of piles or drilled shafts.

Vertical abutment walls will protect bridge ends and the embankment if the walls are extended around the fill slopes to below the depth of anticipated scour. Sheet pile toe walls are usually installed to repair scour damage after a flood. They are commonly used where rock is not available or access for placing rock is difficult. Sheet pile may be used only under guidance from the Bridge Division's Geotechnical Branch.

Revetment is usually placed at the abutment on the slopes under the bridge end and around the corners of the embankment to guard against progressive embankment erosion. Revetment on the fill slope may be susceptible to contraction scour. To prevent embankment failure from undermining by contraction scour, a toewall must be extended below the level of expected scour.

Two common types of revetments used to protect abutments are rigid (i.e. concrete riprap) and flexible (i.e. stone protection, articulated concrete blocks, and gabion mattresses). A unique feature of stone protection is can be designed to be self launching. That is, the rocks will shift to fill any area that scours and inhibit any further scour.

Guide Banks (Spur Dikes)

The twofold purpose of guide banks is to align flow from the floodplain with the waterway opening and minimize scour at the abutment by moving the scour-causing turbulence to the upstream end of the guide bank. Where the floodwater must flow along the embankment for more than 800 feet, guide banks should be considered. Figure 9-20 shows a typical plan form.

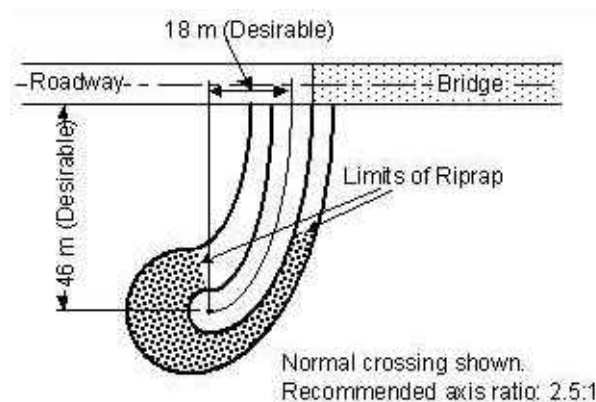

Figure 9-20. Typical Guide Bank

Guide banks are usually constructed of earthen embankment but are sometimes constructed from rock. The dike should be protected by revetment where scour is expected to occur, although a failure at the upstream end of a spur dike usually does not immediately threaten the bridge end.

Clearing around the end of the dike in wooded floodplains should be minimized to enhance the effectiveness. A drainage channel around the end of the dike for local drainage may induce turbulence from mixed flows. Instead, a small culvert through the dike will help minimize the turbulence of mixed flows from different directions.

The suggested shape of guide banks is elliptical with a major-to-minor axis ratio of 2.5:1. The suggested length varies with the ratio of flow diverted from the floodplain to flow in the first 100 feet of waterway under the bridge. The suggested shape is based on laboratory experiments, and the length is based on modeling and field data. The optimum shape and length may differ for each site and possibly for each flood at a site. However, field experience shows, however, that the recommended elliptical shape is usually quite effective in reducing turbulence. Should practical reasons require the use of another shape such as a straight dike, more scour may be expected at the upstream end of the guide banks. Guide banks can also be used at the downstream side of the bridge to help direct flow back into the overbanks.

Bank Stabilization and River Training Devices

Bank stabilization and river training devices are intended to inhibit the erosion and movement of stream banks. They may be needed either to defend against actions of the stream that threaten the highway crossing or to protect the stream banks and the highway from an anticipated response to highway construction.

Various materials and devices designers use include the following:

- ◆ stone protection
- ◆ concrete lining
- ◆ wood, steel, or rock jetties
- ◆ steel or concrete jack fields
- ◆ wire fences
- ◆ timber bulkheads
- ◆ articulated concrete mattresses
- ◆ guide banks, dikes, and spurs (usually constructed of earth and rock).

The choice of the appropriate device or devices for use depends on the geomorphology of the river. Futile attempts at localized control can be avoided where the river is in the midst of changes by studying long reaches. Regardless of the size of the stream and the control measures used, stream response to the measure must be considered. For instance, bank stabilization at a crossing may cause scour in the bed of the channel or redirect the current toward an otherwise stable bank downstream.

Bank stabilization and river training is a specialized field requiring familiarity with the stream and its propensity to change, knowledge of the bed load and debris carrying characteristics of the stream, and experience and experimentation at similar sites on the same or a similar stream.

The following are general principles for the design and construction of bank protection and training works:

- ◆ The cost of the protective measures should not exceed the cost of the consequences of the anticipated stream action.
- ◆ Base designs on studies of channel morphology and processes and on experience with compatible situations. Consider the ultimate effects of the work on the natural channel (both upstream and downstream).
- ◆ Inspect the work periodically after construction with the aid of surveys to check results and to modify the design, if necessary.
- ◆ Understand that the objective of installing bank stabilization and river training measures is to protect the highway. The protective measures themselves are expendable.

Refer to the FHWA publication *Stream Stability at Highway Structures* ([HEC 20](#)) for more detailed information regarding bank stabilization and stream training facilities.

The effectiveness of protective and training measures in many alluvial streams and the need for the measures may be short-term because of the dynamic nature of streams. The stream will move to attack another location or outflank the installation.

A cost comparison of viable options should be made. Alternatives to stream protection measures include the following:

- ◆ a continuing effort to protect the highway by successive installations intended to counter the most recent actions of the stream
- ◆ relocation of the roadway away from the river hazard
- ◆ a larger opening designed to accommodate the hazard
- ◆ abutment foundations designed sufficiently to allow them to become interior bents at a later date.

Minimization of Hydraulic Forces and Debris Impact on the Superstructure

The most obvious design guideline is to avoid the imposition of hydraulic forces on a bridge superstructure by placing the bridge at an elevation above which the probability of submergence is small. Obviously, this is not always economically or physically practical.

One design alternative is to make the superstructure as shallow as possible. Box girders that would displace great volumes of water and have a relatively small weight compared to the weight of water

displaced are not a good design alternative unless the probability of submergence is very small. Solid parapets and curbs that increase the effective depth of the superstructure can give increased buoyancy over that of open rail designs. If submerged, the increased effective depth of the superstructure causes increased general scour, and drag forces on the superstructure are much greater than with open rails.

Another consideration is to provide a roadway approach profile that will be overtopped prior to the submergence of the bridge superstructure. This will reduce the probability of submergence of the bridge and help to reduce the potential for scour at the bridge. The consequence may be the need for repairs to the roadway approach.

Where large volumes of debris are likely to occur, longer spans and high freeboards may be warranted. In extreme situations, debris racks may be installed to stop the debris before it reaches the structure. Bridge designers should consult with Design Division Hydraulics prior to specifying or installing debris racks.

For even a small probability of total or partial submergence, see the Bridge Division [Design Manual](#) for guidance. If the dead load of the structure is not sufficient to resist buoyant, drag, and debris impact forces, the superstructure may need to be anchored to the substructure. Air holes may also be provided through each span and between each girder to reduce the uplift pressure.

Section 7 — Appurtenances

Bridge Railing

The type of railing used on a bridge is as much a hydraulic consideration as one of traffic safety and aesthetics. This is particularly true in instances where overtopping of the bridge is possible. The two types of rail discussed here are:

- ◆ Solid bridge railing -- Solid bridge rail should be used only where the bridge superstructure is in no danger of overtopping. A solid type of rail (e.g., a parapet wall) is useful from a safety standpoint but constitutes a significant impediment to flood flow.
- ◆ Open bridge railing -- The most desirable type of rail for accommodation of flood flow offers the floodwater an opening. An open slender type of bridge railing has a lower backwater and reduced lateral forces than a more solid type. A TxDOT research project was initiated to determine which of the standard TxDOT rails are the most hydraulically efficient. Results from this project are documented in a report, *Hydraulic Performance of Bridge Rails* ([0-5492-1](#)).

Deck Drainage

Effective deck drainage is necessary to minimize the possibilities of vehicular hydroplaning and corrosion of the bridge structure. Generally, it is more difficult to drain bridge decks than approach roadways for several reasons. Deck drainage can be improved by any of the following:

- ◆ providing a sufficient gradient to cause the water to flow to inlets or off the ends of the bridge
- ◆ avoiding zero gradients and sag vertical curves on bridges
- ◆ intercepting all flow from curbed roadways before it reaches the bridge
- ◆ using open bridge rails without curbs, where possible.

Currently, there is a trend toward using watertight joints and carrying all deck drainage to the bridge ends for disposal because of changes in environmental regulations.

Deck drains should be located so that water does not drain directly onto the roadway below. (See [Ponding Considerations](#) in Chapter 10 and *Bridge Deck Drainage Systems*, FHWA-SA-92-010 ([HEC-21](#)) for more information.)

When using downspouts, splash basins should be provided to minimize erosion or tie the downspouts into the storm drain conduit. Drainage should not be allowed to discharge against any part of the structure.

Where practicable, the need to suspend a conduit collection system on the superstructure should be avoided. Collection systems should be designed with cleanouts at all bends, runs as short as practicable, and sufficient gradients provided to minimize problems with debris.

Because of the vulnerability of approach roadway shoulders and foreslopes to erosion from concentrated flow, should be provided sufficient inlet capacity off the bridge ends to intercept flow from the bridge. A closed conduit is often preferable to an open chute down the foreslope because it controls the water in a more positive manner, is aesthetically more pleasing, and is less susceptible to damage by maintenance equipment.

When bridge end drains are not provided with the bridge construction, temporary provisions for protecting the approach fill from erosion should be utilized until permanent measures are installed and functional.

Chapter 10 — Storm Drains

Contents:

[Section 1 — Introduction](#)

[Section 2 — System Planning and Design Considerations](#)

[Section 3 — Runoff](#)

[Section 4 — Pavement Drainage](#)

[Section 5 — Storm Drain Inlets](#)

[Section 6 — Conduit Systems](#)

[Section 7 — Conduit Systems Energy Losses](#)

Section 1 — Introduction

Overview of Urban Drainage Design

Proper drainage of a roadway in an urban region can be more difficult than draining roadways in sparsely settled rural areas for the following reasons:

- ◆ heavy traffic and subsequent higher risks
- ◆ wide roadway sections
- ◆ relatively flat grades, both in longitudinal and transverse directions
- ◆ shallow water courses
- ◆ absence of side ditches and a presence of concentrated flow
- ◆ the potential for costly property damages that may occur from ponding of water or from flow of water through built-up areas
- ◆ a roadway section that must carry traffic and act as a channel to carry the water to some disposal point.

The flow of water along a roadway can interfere with or halt highway traffic. These conditions require sound and consistent engineering principles and the use of all available data to achieve an acceptable drainage design. The primary aim of urban drainage design is to limit the amount of water flowing along the gutters or ponding at the low areas to rates and quantities that will not interfere with traffic. You can accomplish this goal by placing inlets at appropriate locations to prevent large concentrations of runoff. The most destructive effects of an inadequate drainage system are damage to surrounding or adjacent properties, deterioration of the roadway components, and hazard and delay to traffic caused by excessive ponding in sags or excessive flow along roadway grades.

Overview of Storm Drain Design

Although the design of a storm drain system entails many conventional procedures, certain aspects of a storm drain system design require judgment. You must establish design parameters and criteria, decide layout and component location and orientation, take responsibility for using appropriate design tools, and ensure comprehensive documentation.

The development of a storm drain design requires a trial and error approach:

1. Analyze a tentative storm drain system.
2. Compare the system to design criteria.
3. Evaluate the system economically and physically.

4. Revise the system if necessary.
5. Analyze the revised system.
6. Make the design comparisons again.
7. Repeat this process until you develop a storm drain system that satisfies the technical function of collecting and disposing of the runoff and costs the least amount of money.

The proper design of any storm drainage system requires accumulation of certain basic data, familiarity with the project site, and basic understanding of the hydrologic and hydraulic principles and drainage policy associated with that design.

Section 2 — System Planning and Design Considerations

Design Checklist

- ◆ Identify the problem.
- ◆ Develop a system plan.
- ◆ Establish suitable materials and conduit shapes.
- ◆ Establish design criteria.
- ◆ Determine outfall channel flow characteristics.
- ◆ Identify and accommodate utility conflicts.
- ◆ Consider the construction sequence and plan for temporary functioning.
- ◆ Recognize other drainage facilities, and accommodate them.
- ◆ Determine runoff.
- ◆ Design inlets.
- ◆ Design conduit.
- ◆ Develop a hydraulic grade line analysis.
- ◆ Check the final design, and adjust if necessary.
- ◆ Document the design.

Problem Identification

As with any kind of project, you must first clearly define the problem that the proposed design is going to address. For storm drain design, the goal is to provide adequate drainage for a proposed roadway, optimizing safety and minimizing potential adverse impacts.

Schematic

Preliminary or working schematics featuring the basic components of the intended design are invaluable in the design development. After design completion, the schematic facilitates documentation of the overall plan.

You may include the following items in the working schematic:

- ◆ a general layout
- ◆ basic hydrologic data
- ◆ pertinent physical features

- ◆ characteristics of flow diversion (if applicable)
- ◆ detention features (if applicable)
- ◆ outfall location and characteristics
- ◆ surface features (topography)
- ◆ utilities
- ◆ tentative component placement.

The final drainage design schematic should include the existing physical features of the project area and indicate the location and type of the following:

- ◆ streets
- ◆ driveways
- ◆ parking lots
- ◆ bridges
- ◆ adjacent areas indicating land use, such as undeveloped land, commercial land, industrial land, agricultural land, residential land, and park land.
- ◆ detention facilities
- ◆ pump stations
- ◆ drainage channels
- ◆ drainage diversions
- ◆ off-site watershed boundaries.

Material and Shape Selection

Consider all possible storm drain materials with regard to the local environment of the system site. The durability of a drainage facility depends on the characteristics of soil, water, and air. These characteristics may vary from site to site. It is not cost-effective to declare a rule of thumb that the storm drain system should be of one material exclusive of all others.

Base the choice of material and shape on careful consideration of durability, hydraulic operation, structural requirements, and availability.

Durability of drainage facilities is a function of abrasion and corrosion. Except in some mountainous areas of the state, abrasion is not a serious problem. As a rule, durability does not affect the choice of shape directly. Refer to the [Conduit Durability](#) section of Chapter 14 for discussions and design considerations associated with durability. You can usually consult the roadway project's geotechnical report for factors that affect material durability.

The selection of both shape and material for storm drain system components influences the hydraulic capacity. Conduit roughness characteristics vary with conduit material; thus, the hydraulic capacity varies with the material type. For example, reinforced concrete pipe justifies a Manning's n-value of 0.012 while conventional corrugated metal pipe requires the use of an n-value of 0.024 or greater.

When choosing both shape and material, consider cover limitations, headroom, and anticipated loading.

Choose materials, shapes, and components that require minimum transportation costs and that are readily available in the geographic region of the project. Items commonly manufactured in standard sizes include prefabricated pipe, inlets, and manholes.

Deviation from standard sized structures is rarely cost-effective. The pipe industry maintains current standard catalogs of nominal fabrication dimensions. Refer to fabricators' catalogs for current lists of generically available sizes and shapes.

Design Criteria

The design frequency is an indication of the level of flooding accommodated by the system without causing an undesirable impact to pavement, structures, traffic, and adjacent facilities and property.

Base the design frequency for a storm drain system design on the following:

- ◆ the general nature of the system and the area it is to serve
- ◆ the importance of the system and associated roadway
- ◆ the function of the roadway
- ◆ the traffic type (emergency/non-emergency) and demand
- ◆ a realistic assessment of available funds for the project.

Chapter 5 provides a discussion on [design frequency](#) and includes a table of recommended design frequencies.

The allowable ponded width may vary within a single system. For example, an allowable ponded width of one lane of flooding on main lanes and one and one-half lanes for frontage roads may be acceptable. An allowable ponded width is the basis for locating points on the roadway surface at which runoff must be removed. Base the determination of allowable ponded width on such factors as width of roadway, number of lanes, and level of service desired during design frequency.

You may use the following recommended ponded widths with consideration for site specific parameters and limitations:

- ◆ Limit ponding to one-half the width of the outer lane for the main lanes of interstate and controlled access highways.
- ◆ Limit ponding to the width of the outer lane for major highways, which are highways with two or more lanes in each direction, and frontage roads.
- ◆ Limit ponding to a width and depth that will allow the safe passage of one lane of traffic for minor highways.

The usual TxDOT practice is to design for a non-pressure flow network of collector conduits in most storm drain systems.

Critical elevations are used as comparative values to the key elevations on a developed hydraulic grade line. (See Chapter 6 for more information.) As a rule, a surface water removal system is designed to operate with no impedance or interruption of free fall into the system. Therefore, the system does not perform as predicted by the calculations if the backwater (hydraulic grade line) within the system rises to a level above a curb and gutter grade, a manhole, or any other critical elevation in a storm drain system. Water will either back out on the roadway or runoff will be impeded from entering the system as planned. You need to identify the critical elevations where these problems most likely will exist and compare the resultant hydraulic grade line. Typical critical elevations would be located at the throats of inlets and tops of manholes. For the design frequency, the hydraulic grade line should not exceed the critical elevation.

The usual preference is that flow velocities within the conduit network be no less than 2 fps (0.6 m/s) and no greater than about 12 fps (3.6 m/s). At velocities less than 2 fps (0.6 m/s), sediment deposit becomes a serious maintenance problem. Such slow velocities also indicate an inefficient drainage system. At flow velocities greater than about 12 fps (3.6 m/s), structural damage to the system components becomes a threat. The momentum of flow at higher velocities can cause a damaging impact on the structural components and connections within the system. There may be instances when design velocities outside the range of 2fps and 12 fps (0.6 m/s and 3.6 m/s) are necessary. If so, countermeasures such as greater access for maintenance or strengthened components may be in order.

Outfall Considerations and Features

The outfall of the storm drain system is a key component, and you must coordinate with the demands of the physical and hydraulic characteristics of the system. Consider the requirements and characteristics of the area in which the outfall facility is located. Important considerations in the identification of an appropriate system outfall include the following:

- ◆ the availability of the channel and associated right-of-way or easement
- ◆ the profile of the existing or proposed channel or conduit
- ◆ the flow characteristics under flood conditions

- ◆ the land use and soil type through the area of the channel.

Whether the outfall is enclosed in a conduit or is an open channel, you should assess its ability to convey design flows. If necessary, modify the outfall to ensure minimizing the potential for significant impact.

An outfall for a TxDOT storm drain system must be operated for the life of the system. This implies that TxDOT must have access to all parts of the outfall for purposes of maintenance and to ensure adequate operation of the drainage system. If the outfall is by easement through private property, assure continuing TxDOT access to the outfall within that easement. In many instances, it is necessary to purchase an outfall right-of-way (drainage easement) so that continuing access by the TxDOT is assured.

Special Outfall Appurtenances

When separate storm drain systems intersect, a bubble chamber may be useful to provide a means of connecting the systems. You can design the bubble chamber so that as the water level (hydraulic grade line) in one system rises to a certain level, flow in another system serves as a relief drainage facility.

If the outfall to be used by a storm drain system is permanently or temporarily inadequate to accommodate the flow from the system, you may need to install some type of flow restrictor. The flow restrictor must include a space for runoff detention, allowing a reduced runoff rate to exit into the inadequate outfall.

Flap gates are provided when an outfall might cause the storm drain system to back up. A flap gate allows flow out during lower outfall levels and prevents backflow when the water level is higher. For example, if the storm drain system is to outfall into a tidal basin in which the periodic fluctuation of tides represents a variation of possible outfall water levels, you may need to provide a flap gate at the end of the last downstream run of the system.

Utility Conflicts

Direct consideration and planning toward minimizing conflicts with existing utilities and potential conflicts with future utilities. During design, the order of considerations is as follows:

1. Carefully identify each utility and associated appurtenances that may be in conflict with any part of the storm drain system. Consider in the design any utility that intersects, conflicts, or otherwise affects or is affected by the storm drain system. Determine the horizontal and vertical alignments of underground utilities to properly accommodate potential conflicts. The following are typical utilities that you may encounter in an urban situation:
 - electrical
 - telephone or television transmission lines

- water lines
 - wastewater lines
 - gas lines
 - irrigation ditches
 - high-pressure fuel facilities
 - communication transmission facilities.
2. Where reasonable, relocate components of the storm drain system to avoid utility conflict.
 3. When relocation of the storm drain is not feasible, arrange for the relocation or adjustment of the utility. The entity responsible for the utility is usually cooperative in such cases.
 4. Make accommodations to the utility when adjustments are not feasible due to economics or other conditions. For example, it may be unreasonable to relocate a high-pressure gas line. In such a case, design an intersection of the unadjusted utility appurtenance and the subject component of the storm drain system. This may involve passing the utility through the storm drain component (e.g., through a junction box) or installing a syphon. The utility company may be on state right-of-way under the agreement that TxDOT may request utility adjustments. However, as a general objective, attempt to minimize the disruption to utilities.

Construction

The construction sequence of the various storm drains can have a major influence on the design. The need to comply with the [National Pollutant Discharge Elimination System](#) (NPDES) General Permit for construction activities has increased the importance of proper sequencing.

The system must function, perhaps to a lesser extent, during the time of project construction. It must function adequately (but probably not optimally) both with the rest of the storm drain system and other project aspects. For example, it is usually recommended that storm drain lines be built from downstream to upstream in order to prevent “trapping” storm water during construction. Phase the storm drain system construction to accommodate the following:

- ◆ sequences of roadway construction
- ◆ traffic control
- ◆ cut and fill operations
- ◆ utility construction
- ◆ structural operations.

Identification of Other Drainage Facilities

You should attempt to identify any existing or proposed facilities that your proposed system is likely to affect or which may affect your proposed system. Examples include the following:

- ◆ regional or local storm water detention facilities
- ◆ proposed or recent changes to adjacent highway facilities
- ◆ municipal master drainage plans
- ◆ other major development.

Design Documentation

Design documentation needs for the development of a storm drain design include the following:

- ◆ watershed data
- ◆ estimates of future development of watersheds
- ◆ channel flow characteristics in outfall
- ◆ logical inlet locations
- ◆ curb and gutter slopes
- ◆ transverse slopes
- ◆ inlet calculations
- ◆ times of concentration to each location (node)
- ◆ rainfall intensity calculations
- ◆ depth of flow and ponded width of curb/gutter flow
- ◆ inlet sizing calculations
- ◆ carryover rates
- ◆ conduit slopes
- ◆ conduit sizing calculations
- ◆ conduit run travel times
- ◆ critical elevations
- ◆ hydraulic grade line elevations.

Documentation Requirements

The design is not complete until the following are documented:

- ◆ criteria
- ◆ design parameters
- ◆ considerations

- ◆ calculations.

The documentation serves several important purposes including:

- ◆ justification of the design
- ◆ reference for review and checking
- ◆ reference for potential field changes and future modifications
- ◆ potential defense against litigation.

The [Storm Drain Documentation Check List](#) presents required documentation for storm drain systems.

Section 3 — Runoff

Hydrologic Considerations for Storm Drain Systems

Show watershed boundaries on the schematic. As inlet locations within the established system are finalized, you can indicate intermediate drainage boundaries. Either show schematically or otherwise describe component parts of contributing watersheds (subareas). See Chapter 4 for discussion of field surveys, and see Chapter 5 for hydrologic considerations.

Flow Diversions

Generally, a storm drain system should accommodate the natural drainage area. Avoid diversion of flow from one watershed to another. Where diversion of flow has already occurred, you may need to consider the implications of accommodating the diversion. However, it is not the usual practice or aim of TxDOT to divert runoff flows from one major watershed to another. If and when it is unavoidable, you must consider the impacts of flow diversion. You may be required to coordinate with the [Texas Commission on Environmental Quality](#) (TCEQ) in many instances, and you should investigate this early in the planning and design process. (See [Reference](#) for information on contacting the TCEQ.)

Detention

Detention does not change the total volume of runoff. However, the runoff rates change depending on the characteristics of the flood and the detention facility. Such facilities may be in the form of holding reservoirs, large borrow ditches, and underground storage sumps.

TxDOT has not usually incorporated detention into designed systems because the department's chief aim is to remove and dispose of runoff as quickly and effectively as possible. With increased development in Texas, greater runoff rates and quantities have occurred, causing the need for larger and more costly drainage structures. The greater rates and quantities may also damage downstream development.

You may incorporate a detention facility into a design for drainage systems to decrease facility costs and diminish possible damages due to the increased runoff rates and quantities. With this aim, many municipalities, counties, and other entities in Texas have begun to require detention as an integral part of drainage design. Additionally, you may need to design a detention system for multiple use, especially for storm water quantity and quality control.

Determination of Runoff

In a storm drain design, first determine the peak flow runoff. The Rational Method, discussed in Chapter 5, is the method that applies to the vast majority of the types of watersheds that storm drains handle.

The [time of concentration](#) in a storm drainage design is comprised of the time required for water to flow from the most distant point of the drainage area to the inlet (called inlet time) and the travel time as the water flows through the storm drain line under consideration (travel time through a conduit). See [Procedure to Estimate Time of Concentration](#) in Chapter 5 for more information.

Other Hydrologic Methods

For the urban area under consideration, the TxDOT designer may need to use a special hydrologic method because of some funding arrangements. For example, if a city is funding the surface drainage facilities, that city may insist on using its own specific hydrologic method. Usually, such special methods are similar to the Rational Method with some minor variations.

Some situations may require the use of some variation of Natural Resources Conservation Service (NRCS) hydrologic estimating methods such as the NRCS TR-55 or TR-20 procedure. (See [References](#) for information on contacting this agency.) In other situations, the use of a unit hydrograph procedure may be in order. Refer to [NRCS Runoff Curve Number Methods](#) in Chapter 5 for detailed information on the NRCS methods.

Where considerable storage is required in the storm drain system, employ hydrologic routing methods to accommodate peak flow attenuation. Refer to Chapter 5 for information on [flood hydrograph routing methods](#).

Section 4 — Pavement Drainage

Design Objectives

A chief objective in the design of a storm drain system is to move any accumulated water off the roadway as quickly and efficiently as possible. Where the flow is concentrated, the design objective should be to minimize the depth and extent of that flow.

Appropriate longitudinal and transverse slopes can serve to move water off the travel way to minimize ponding, sheet flow, and low crossovers. This means that you must work with the roadway geometric designers to assure efficient drainage in accordance with the geometric and pavement design.

Ponding

Restrict the flow of water in the gutter to a depth and corresponding width that will not cause the water to spread out over the traveled portion of the roadway in a depth that obstructs or poses a hazard to traffic. The depth of flow should not exceed the curb height. The depth of flow depends on the following:

- ◆ rate of flow
- ◆ longitudinal gutter slope
- ◆ transverse roadway slope
- ◆ roughness characteristics of the gutter and pavement
- ◆ inlet spacing.

Place inlets at all low points in the roadway surface and at suitable intervals along extended gutter slopes as necessary to prevent excessive ponding on the roadway. In the interest of economy, use a minimum number of inlets, allowing the ponded width to approach the limit of allowable width specified as a design criterion. In instances such as a narrow shoulder or low grades, you may need to plan a continuous removal of flow from the surface.

Longitudinal gutter slopes should usually not be less than 0.3% for curbed pavements. This minimum may be difficult to maintain in some locations. In such situations, a rolling profile (or sawtooth grade) may be necessary. You may need to warp the transverse slope to achieve a rolling gutter profile. Figure 10-1 shows a schematic of a sawtooth grade profile. Extremely long sag-vertical curves in the curb and gutter profile are discouraged because they incorporate relatively long, flat grades at the sag. Such long, flat slopes tend to distribute runoff across the roadway surface instead of concentrating flow within a manageable area.

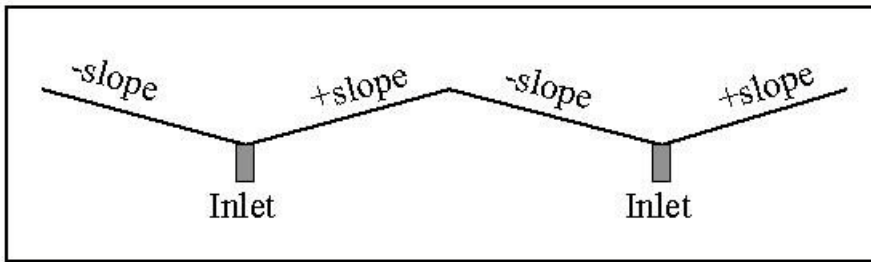

Figure 10-1. Sawtooth Gutter Profile

Transverse Slopes

Except in cases of super-elevation for horizontal roadway curves, the pavement transverse slope is usually a compromise between the need for cross slopes adequate for proper drainage and relatively flat cross slopes that are amenable to driver safety and comfort. Generally, transverse slopes of about 2 % have little effect on driver effort or vehicle operation. If the transverse slope is too flat, more depth of water accumulation is necessary to overcome surface tension. Furthermore, once water accumulates into a concentrated flow in a flat transverse slope configuration, the spread of the flow (ponded width) may be too wide. These characteristics are the chief causes of [hydroplaning](#) situations. Therefore, an adequate transverse slope is an important countermeasure against hydroplaning.

For TxDOT projects, a recommended minimum transverse slope for tangent roadway sections is 2%. The recommended maximum transverse slopes for a tangent roadway section is 4%. Refer to the [Roadway Design Manual](#) for recommendations concerning super-elevation values for horizontal curves in roadways. Ensure that cross slope transitions, such as those required in reverse curves, are designed to avoid flat cross-slopes in sag vertical curves.

You can effectively reduce the depth of water on pavements by increasing the cross slope for each successive lane in a multi-lane facility. In very wide multi-lane facilities, the inside lanes may be sloped toward the median. However, do not drain median areas across traveled lanes. In transitions into horizontal curve super-elevation, minimize flat cross slopes and avoid them at low points of a sag profile. It is usually in these transition regions where small, shallow ponds of accumulated water, or “birdbaths,” occur.

Use of Rough Pavement Texture

The potential for hydroplaning may be minimized to some extent if the pavement has a rough texture. Cross cutting (grooving) of the pavement is useful for removing small amounts of water such as in a light drizzle. TxDOT discourages longitudinal grooving because it usually causes problems in vehicle handling and tends to impede runoff from moving toward the curb and gutter. A very rough pavement texture benefits inlet interception. However, in a contradictory sense, very rough

pavement texture is unfavorable because it causes a wider spread of water in the gutter. Rough pavement texture also inhibits runoff from the pavement.

Gutter Flow Design Equations

Figure 10-2 illustrates [ponding spread](#). Pondered width is commonly designated as T .

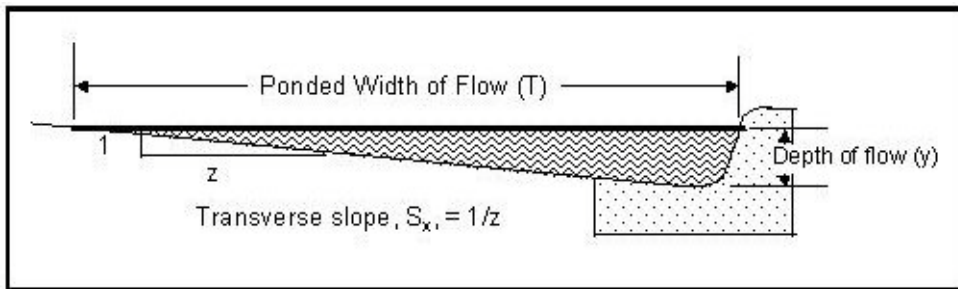

Figure 10-2. Gutter Flow Cross Section Definition of Terms

The ponded width is a geometric function of the depth of the water (y) in the curb and gutter section. For storm drain system design in TxDOT, the depth of flow in a curb and gutter section with a longitudinal slope (S) is taken as the uniform (normal) depth of flow, using Manning's Equation for [Depth of Flow](#) as a basis. (See Chapter 6 for more information.) Ordinarily, it would not be possible to solve for uniform depth of flow directly from Manning's Equation. For Equation 10-1, the portion of wetted perimeter represented by the vertical (or near-vertical) face of the curb is ignored. This justifiable expedient does not appreciably alter the resulting estimate of depth of flow in the curb and gutter section.

$$y = z \left(\frac{QnS_x}{S^{1/2}} \right)^{3/8}$$

Equation 10-1.

where:

y = depth of water in the curb and gutter cross section (ft. or m)

Q = gutter flow rate (cfs or m^3/s)

n = Manning's roughness coefficient

S = longitudinal slope (ft./ft. or m/m)

S_x = pavement cross slope (ft./ft. or m/m)

$z = 1.24$ for English measurements or 1.443 for metric.

Refer to Figure 10-2, and translate the depth of flow to a ponded width on the basis of similar triangles.

$$T = \frac{y}{S_x}$$

Equation 10-2.

where:

T = ponded width (ft. or m).

Determine the ponded width in a sag configuration with Equation 10-2 using depth of standing water or head on the inlet in place of y . Combine Equation 10-1 and Equation 10-2 to compute the gutter capacity using Equation 10-3.

$$Q = \frac{z}{n} S_x^{5/3} S^{1/2} T^{8/3}$$

Equation 10-3.

where:

$z = 0.56$ for English measurements or 0.377 for metric.

Rearranging Equation 10-3 gives a solution for the ponded width, T .

$$T = z \left(\frac{Qn}{S_x^{5/3} S^{1/2}} \right)^{3/8}$$

Equation 10-4.

where:

$z = 1.24$ for English measurements or 1.443 for metric.

The table below presents suggested Manning's "n" values for various pavement surfaces. The department recommends use of the rough texture values for design.

Manning's n-Values for Street and Pavement Gutters

Type of gutter or pavement	n
Asphalt pavement:	-
Smooth texture	0.013
Rough texture	0.016
Concrete gutter with asphalt pavement:	-
Smooth texture	0.013
Rough texture	0.015
Concrete pavement:	-
Float finish	0.014
Broom finish	0.016

Equation 10-3 and Equation 10-4 apply to portions of roadway sections having constant cross slope and a vertical curb. Refer to the FHWA publication “*Urban Drainage Design Manual*” ([HEC-22, 1996](#)) for parabolic and other shape roadway sections.

Ponding on Continuous Grades

Avoid excessive ponding on continuous grades by placing storm drain inlets at frequent intervals. Determine the gutter ponding at a specific location (such as an inlet) on a continuous grade using the following steps:

1. Determine the total discharge in the gutter based on the drainage area to the desired location. See [Runoff](#) for methods to determine discharge.
2. Determine the longitudinal slope and cross-section properties of the gutter. Cross-section properties include transverse slope and Manning’s roughness coefficient.
3. Compute the ponded depth and width. For a constant transverse slope, compute the ponded depth using Equation 10-1 and the ponded width using Equation 10-2. For parabolic gutters or sections with more than one transverse slope, refer to the FHWA publication “*Urban Drainage Design Manual*,” (HEC 22, 1996). For information on obtaining this publication, see [References](#).

Ponding at Approach to Sag Locations

At sag locations, consider sag inlet capacity, flow in the gutter approaching the left side of the sag inlet, and flow in the gutter approaching the right side of the sag inlet, and avoid exceeding allowable ponding:

1. Estimate the apportionment of runoff to the left and right approaches. Considering the limitations of the hydrologic method employed (usually the Rational Method - see information on the [Determination of Runoff](#)), it is reasonable to compute the discharge to the sag location based on the entire drainage area and determine the approximate fraction of area contributing to each side of the sag location. Multiply each fraction by the total discharge to determine the discharge to each side.
2. Determine the longitudinal slope of each gutter approach. For sawtooth profiles, the slopes will be the profile grades of the left and right approaches. However, if the sag is in a vertical curve, the slope at the sag is zero, which would mean that there is no gutter capacity. In reality there is a three-dimensional flow pattern resulting from the drawdown effect of the inlet. As an approximation, one reasonable approach is to assume a longitudinal slope of one half of the tangent grade.
3. For each side of the sag, calculate the ponded depth and width. Use the appropriate flow apportionment, longitudinal slope, and [Equation 10-1](#). Compute the ponded width using [Equation 10-2](#).

Hydroplaning

As rain falls on the roadway surface, the water accumulates to some depth before overcoming surface tension and running off. A vehicle encountering water on the road may hydroplane, the vehicle's tires planing on top of the accumulated water and sliding across the water surface. Hydroplaning is a function of rainfall intensity and resulting water depth, air pressure in the tires, tread depth and siping pattern of the vehicle tires, condition and character of the pavement, and vehicle speed.

Because the factors that influence hydroplaning are generally beyond the designer's control, it is impossible to prevent the phenomenon. However, minimize the physical characteristics that may influence hydroplaning:

- ◆ The greater the transverse slope on the pavement, the less the potential for water depth buildup and potential for hydroplaning. A minimum cross slope of 2% is recommended. The longitudinal slope is somewhat less influential in decreasing the potential for hydroplaning. You must establish coordinate establishment of these slopes with the geometric design to ensure adequate provisions against hydroplaning.
- ◆ Studies have indicated that a permeable surface course or a high macrotexture surface course has the highest potential for reducing hydroplaning problems.
- ◆ As a guideline, a wheel path depression in excess of about 0.2 in. (5 mm) has potential for causing conditions that may lead to hydroplaning.
- ◆ Grooving may be a corrective measure for severe localized hydroplaning problems. However, grooving that is parallel to the roadway traffic direction may be more harmful than useful because of the potential for retarding sheet flow movement.
- ◆ Do not use transverse surface drains located on the pavement surface.

Rainfall intensities can be so high in Texas that the designer cannot eliminate the potential for hydroplaning. Because rainfall intensities and vehicle speed are primary factors in hydroplaning, the driver must be aware of the dangers of hydroplaning. In areas especially prone to hydroplaning where you have employed reasonable measures to minimize the potential for hydroplaning, the department should use wet weather warning signs to warn the driver of the danger.

Vehicle Speed in Relation to Hydroplaning

You can evaluate the potential for hydroplaning using an empirical equation based on studies conducted for the USDOT (FHWA-RD-79-30 and 31-1979, Bridge Deck Drainage Guidelines, RD-87-014).

Equation 10-5 and Equation 10-6 provide in English and metric units a means of estimating the vehicle speed at which hydroplaning occurs.

English:

$$v = SD^{0.04} P^{0.3} (TD + 1)^{0.06} A$$

Equation 10-5.

Metric:

$$v = 0.9143SD^{0.04} P^{0.3} (TD + 0.794)^{0.06} A$$

Equation 10-6.

where:

v = vehicle speed at which hydroplaning occurs (mph or km/h)

$SD = [W_d - W_w / W_d] * (100)$ = spindown percent (10 % spindown is used as an indicator of hydroplaning)

W_d = rotational velocity of a rolling wheel on a dry surface

W_w = rotational velocity of a wheel after spinning down due to contact with a flooded pavement

P = tire pressure (psi or kPa), use 24 psi or 165 kPa for design

TD = tire tread depth (in. or mm), use 2/32-in. or 0.5 mm for design)

WD = water depth, in. or mm (see Equation 10-7).

$$\left[\frac{10.409}{WD^{0.06}} + 3.507 \text{ or } \left\{ \frac{28.952}{WD^{0.06}} - 7.817 \right\} \right] * TXD^{0.14}$$

For metric, the greater of

$$\left[\frac{12.639}{WD^{0.06}} + 3.50 \text{ or } \left\{ \frac{22.351}{WD^{0.06}} - 4.97 \right\} \right] * TXD^{0.14}$$

NOTE: This equation is limited to vehicle speeds of less than 55 mph (90 km/h).

Water Depth in Relation to Hydroplaning

Equation 10-7 provides for evaluating the depth of storm water on pavement.

$$WD = z \left\{ \frac{TXD^{0.11} L^{0.43} I^{0.59}}{S^{0.42}} \right\} - TXD$$

Equation 10-7.

where:

z = 0.00338 for English measurement or 0.01485 for metric

WD = water depth (in. or mm)

TXD = pavement texture depth (in. or mm) (use 0.02 in. or 0.5 mm for design)

L = pavement width (ft. or m)

I = rainfall intensity (in./hr or mm/hr)

S = pavement cross slope (ft./ft. or m/m).

After calculating water depth, check design speed. If hydroplaning is a concern, several possibilities exist:

- ◆ The cross-slope could be increased. Pavement cross-slope is the dominant factor in removing water from the pavement surface. A minimum cross-slope of 2% is recommended.
- ◆ Pavement texture could be increased. However, no technical guidance appears to be available on the relationship between texture depth and pavement surface type.
- ◆ Reduce the drainage area. If possible, reduce width of drained pavement by providing crowned section or by intercepting some sheet flow with inlets such as slotted drains.
- ◆ The speed limit could be reduced for wet conditions.

If physical adjustments to the roadway conditions are not practicable, consider providing appropriate warning of the potential hazard during wet conditions.

Section 5 — Storm Drain Inlets

Inlet Types

You can divide inlets used for the drainage of highway surfaces into four major classes:

- ◆ Curb opening inlets - See [Figure 10-3](#).
- ◆ Grate inlets - See Figure 10-5.
- ◆ Slotted drains - Slotted inlets function in essentially the same manner as curb opening inlets, i.e., as weirs with flow entering from the side. See [Figure 10-6](#).
- ◆ Combination inlets -- Combination inlets usually consist of some combination of a curb-opening inlet, a grate inlet, and a slotted drain. In a curb and grate combination, the curb opening may extend upstream of the grate. In a grate and slotted drain combination, the grate is usually placed at the downstream end of the slotted drain.

Curb Opening Inlets

Figure 10-3 illustrates a generic example of a typical curb opening inlet. Curb inlets are used in urban sections of highway along the curb line on continuous grades (on-grade) and at sag locations.

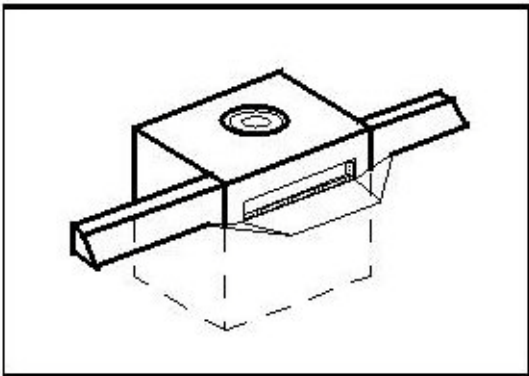

Figure 10-3. Curb Opening Inlet

Most curb opening inlets depend heavily upon an adjacent depression in the gutter for effective flow interception (see [Figure 10-4](#)). Greater interception rates result in shorter (and probably, more economical) inlet lengths. However, a large gutter depression can be unsafe for traffic flow moving near the gutter line. Therefore, a compromise is in order when selecting an appropriate value for the gutter depression. The depth of the gutter depression should be:

- ◆ 0 to 1 in. (0 to 25 mm) where the gutter is within the traffic lane
- ◆ 1 to 3 in. (25 to 75 mm) where the gutter is outside the traffic lane or in the parking lane
- ◆ 1 to 5 in. (25 to 125 mm) for lightly traveled city streets that are not on a highway route.

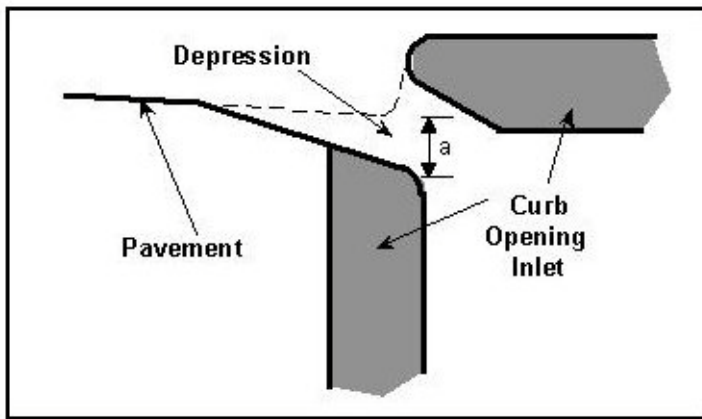

Figure 10-4. Curb Opening Inlet Depression

Some municipalities in the state prefer to recess curb inlets with significant depression to minimize interference with traffic flow. The inlet is recessed from the line of the curb and gutter such that the depression does not extend beyond the gutter line. This may improve driveability; however, the curb transition may pose a hazard to traffic.

Curb opening inlets are useful in sag and on-grade situations because of their self-cleansing abilities and hydraulic efficiency. Additionally, they are often preferred over grate inlets because the inlet is placed outside the travel way and poses less of a risk to motorists and bicycle traffic.

A drawback of curb opening inlets is that the flowline of the opening is fixed and not readily adaptable to changing pavement levels as occur in surface treatment overlays. Successive overlays can gradually reduce or even eliminate the original opening available for water removal, unless the pavement edge is tapered to the original gutter line.

Grate Inlets

Figure 10-5 illustrates a typical grate inlet. Water falls into the inlet through a grate instead of an opening in the curb. Designers use many variations of this inlet type, and the format of the grate itself varies widely as each foundry may have its own series of standard fabrication molds.

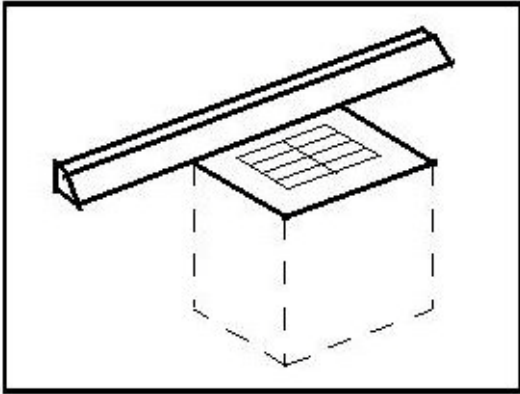

Figure 10-5. Grate Inlet Schematic

For the most part, use grate inlets in sag configurations in gutters adjacent to concrete traffic barriers or rails (where curb inlets would not be practicable), V-shaped gutters with no curb or barrier, and ditches. You may also use them in on-grade situations with curb inlets. Where you expect the grate inlet to intercept gutter flow in an on-grade configuration, the grate openings should be oriented parallel to the gutter flow in order to maximize hydraulic efficiency.

Grate inlets adapt to urban roadway features such as driveways, street intersections, and medians. When grate inlets are specified, assure that the grate configuration and orientation are compatible with bicycle and wheelchair safety. Consult with TxDOT's State Bicycle Coordinator and the Design Division for additional information.

Access to the storm drain system through a grate inlet is excellent in that, usually, the grate is removable. On the other hand, maintenance of grate inlets can be a continuing problem during the life of the facility; their propensity to collect debris make grate inlets a constant object of maintenance attention. As such debris accumulates, it obstructs the flow of surface water into the inlet. Grate inlets also present potential interference with bicycles and wheelchairs.

Slotted Drains

See Figure 10-6 for an illustration of a slotted drain installation. The throat of a slotted drain inlet is ordinarily reinforced for structural integrity. The top of the throat is constructed flush with the surface of the pavement or the gutter.

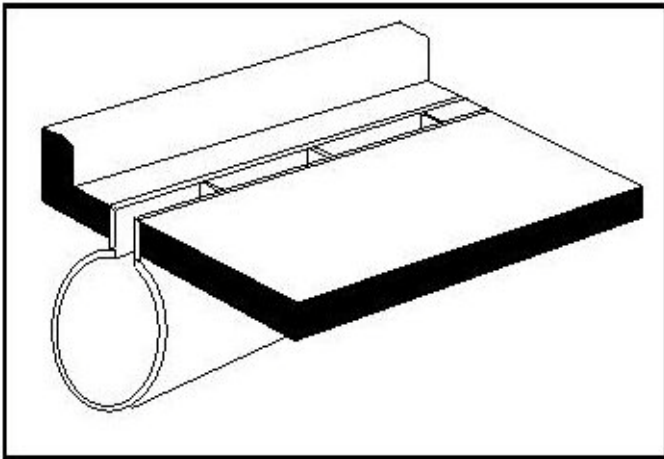

Figure 10-6. Slotted Drain Inlet

Slotted drains may be an alternative to on-grade curb and grate inlets along curb lines. Also, they can be placed across driveways and street intersections.

Design for the removal of sheet flow from the roadway by strategically placing slotted drain pipe installations. Such installations may occur within the traveled way, either transversely or longitudinally. Where drainage is toward the inside of lanes and against median barriers, an installation of slotted drain pipe with appropriate outfall can be effective in removing accumulated runoff.

In asphalt concrete pavement applications, ensure structural integrity either by adequate structural characteristics of the slotted pipe or encasement in concrete such as illustrated in Figure 10-7. Refer to the Bridge Division inlet standards, SD (M), concerning the proper type of slotted drain to use in these situations.

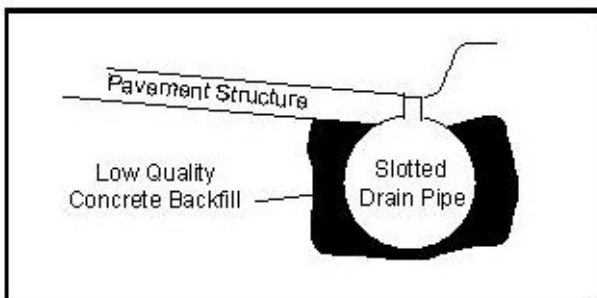

Figure 10-7. Slotted Drain Structural Integrity

Slotted drains have the following advantages:

- ◆ They are adaptable to intersections with urban roadway features such as driveways, street intersections, and sidewalks.
- ◆ They can accommodate AASHTO HS 20 vehicular traffic as well as bicycles, wheel chairs, and some pedestrian traffic.

- ◆ No depression is necessary for hydraulic efficiency.
- ◆ Continuous sheet or gutter flow interception is possible at a relatively small cost.
- ◆ Construction is very simple and proceeds quickly.
- ◆ Pavement overlays or other surface treatment can be accommodated without any effect on the original intended hydraulic characteristics.
- ◆ Slotted drain inlets in on-grade configurations are essentially self-cleaning.
- ◆ They are aesthetically pleasing.

Disadvantages of slotted drain inlets include the following:

- ◆ They have a high propensity to collect debris in sag configurations; therefore, do not use them in sag configurations.
- ◆ Effective maintenance access usually requires an adjacent manhole or an adjacent curb opening or grate inlet.
- ◆ Slotted drain pipes may have structural connector problems at locations where there are flexible joints in the roadway structure.

Combination Inlets

Combination inlets such as curb and grate can be useful in many configurations, especially sag locations. Because of the inherent debris problem in sags, the combination inlet offers an overflow drain if part of the inlet becomes completely or severely clogged by debris. Maintenance of combination inlets is usually facilitated by the fact that the grate is removable, providing easy access to the inlet and associated storm drain system.

Combination inlets used on-grade are generally not cost-effective because of the relatively small additional hydraulic capacity afforded. Authentic data on such combinations are insufficient to establish accurate factors for determining the true capacity of a combination inlet.

For a combination curb and grate, assume that the capacity of the combination inlet comprises the sum of the capacity of the grate and the upstream curb opening length. Ignore the capacity of the curb opening that is combined with the grate opening.

Inlets in Sag Configurations

An inlet in a sag configuration is the “end of the line” because the water and its debris load have no other place to go. Because of this, failure of an inlet in a sag configuration often represents a threat to the successful operation of a storm drain system, and you must consider some additional items. In a sag configuration, the controlling ponded width can be from one of three origins. The inlet itself may cause a head that translates to a ponded width. Furthermore, as water approaches the sag

configuration inlet from each of two directions, the flow in the curb and gutter from each direction subtends its own ponded width. If the sag configuration inlet is in the trough of a vertical curve, the slope in the immediate vicinity of the sag inlet is equal to 0 %. Therefore, no specific slope is available for the computation of gutter flow characteristics. If the low point inlet is located at the intersection of two tangent approach slopes with no vertical curve, use the actual longitudinal slopes for the calculation of flow depths in the gutter.

Because the water or its debris load can go no other place, apply an appropriate safety factor to the inlet size. For grate inlets in sags, the usual safety factor is approximately two. For curb inlets, the ratio can be somewhat less. This is conventional practice for the TxDOT. For example, if a low point grate inlet requires an open area of 4.1 sq.ft. (2.1 m²) and the standard inlet open area is 4.0 sq.ft. (2.0 m²), provide two inlets for a total open area of 8.0 sq.ft. (4.0 m²) (safety factor = 1.9).

In addition, where significant ponding can occur such as in underpasses and in sag-vertical curves, it is good engineering practice to place flanking inlets on each side of the sag location inlet. Analyze flanking inlets as inlets on-grade at some specified distance away from the low point on the sag vertical curve. Often, the specified distance is 50 or 100 ft. (15 or 30 m). The on-grade inlets serve to relieve some or most of the flow burden from the inlet located at the low point. Place the flanking inlets so that they will limit spread on low gradient approaches to the level point and act in relief of the sag inlet if it should become clogged or if the design spread is exceeded.

Median/Ditch Drains

Drains or inlets appearing in ditches and medians are usually grate inlets and are also termed “drop inlets.” Often, such an inlet is in a sag (sump) configuration. In sag configurations, drains have a high probability for maintenance problems. As with grate inlets in gutters, grate inlets used in medians or other ditches should usually have the grate bars aligned parallel to the flow. A concrete riprap collar that forms a type of bowl around the inlet will improve the operational characteristics of the facility. If the inlet in the median or ditch is in an on-grade configuration, you may need to provide a downstream dike or “ditch block” as illustrated in Figure 10-8.

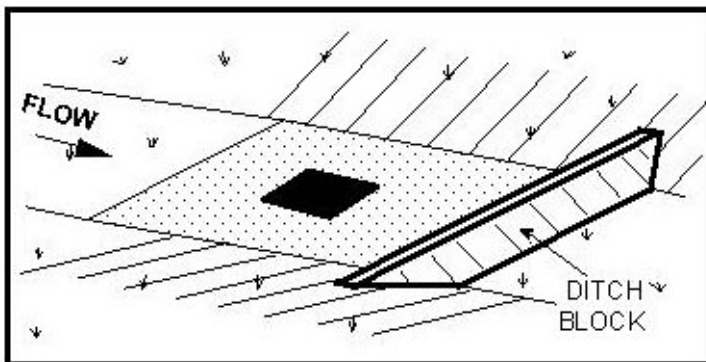

Figure 10-8. Median/Ditch Inlet

Over-side drains, also referred to as drainage chutes, are used when no inlet at the curb and gutter line connects to a storm drain system. An opening in the curb connecting to a scour-resistant channel or chute removes the concentrated flow in the curb and gutter from the roadway. In some instances, you may replace the channel or chute with a small pipe placed in the roadway embankment as illustrated in Figure 10-9.

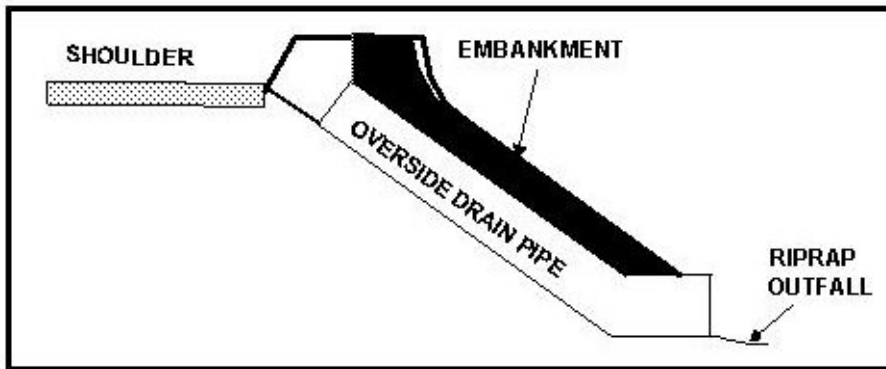

Figure 10-9. Over-Side Drains

Inlet Locations

The inlet location may be dictated either on the basis of physical demands, hydraulic requirements, or both. In all instances, you must coordinate the inlet location with physical characteristics of the roadway geometry, utility conflicts, and feasibility of underground pipe layout.

Establish logical locations early on as permanent and non-adjustable fixtures in the storm drain system. Determine their hydraulic characteristics in the ordinary trial and error process of storm drain design. Logical locations for inlets include sag configurations, near street intersections, at gore islands (see Figure 10-10), and super-elevation transitions.

Inlets with locations not established by physical requirements should be located on the basis of hydraulic demand.

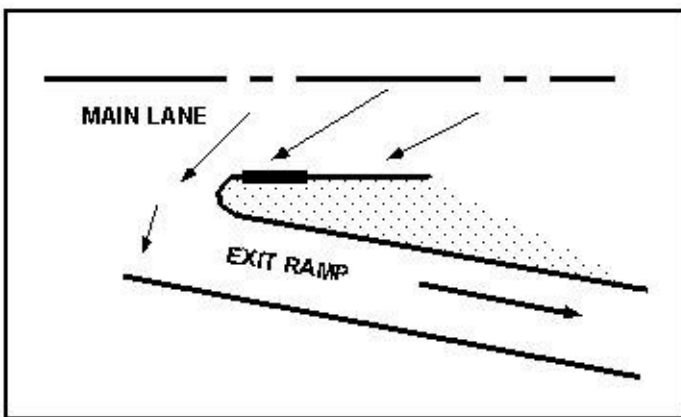

Figure 10-10. Inlet at a Gore Island

Ponded Width Options

An on-grade inlet may be necessary to remove some or all of the flow at that point so that the basic design criterion, allowable ponded width, is not violated. For a given tentative inlet location, determine the ponded width to that point. Figure 10-11 shows interdependence of inlet location, drainage area, discharge, and ponded width. If the calculated ponded width is greater than the allowable ponded width, you have two options:

- ◆ Relocate the inlet at a point upstream in the curb and gutter section. This reduces the watershed area and, thus, the peak discharge. The lowered peak discharge causes a smaller ponded width. If this is done, the drainage area to the next downstream location is increased, thus increasing the discharge and ponding.
- ◆ Locate an intermediate inlet at some point upstream in the curb and gutter section. This intermediate inlet defines a new watershed from which a reduced discharge flows, reducing the ponded width at the original inlet location.

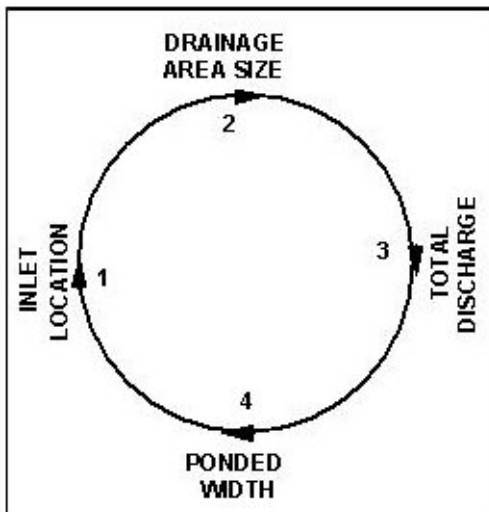

Figure 10-11. Relation of Inlet Location to Design Discharge

If the calculated ponded width is less than or equal to the allowable ponded width, you must decide if it represents an efficient design. Compare the calculated ponded width to the allowable ponded width as a measure of efficiency. If you use all or most of the allowable ponded width, the location is probably efficient. If you use only a small portion of the allowable ponded width, a more efficient location may be possible. In extensive storm drain systems, it should be a design objective to minimize the number of inlets. You may do this effectively by using as much of the allowable ponded width as is possible.

Carryover Design Approach

By using an on-grade inlet to intercept only a portion of the total flow in the gutter, you can make the inlet much more efficient than if all of the flow were to be intercepted. The rate of gutter flow

not intercepted is called carryover. This design approach is recommended in those instances where it is not necessary to intercept all of the flow. The approach can be applied only in on-grade inlet configurations.

Figure 10-12 illustrates (in profile) approximately what happens when the inlet is designed to intercept all of the approaching flow. Note the large portion of inlet opening that is not utilized efficiently.

Figure 10-13 illustrates (in profile) approximately what happens when the inlet is designed to intercept less than all of the approaching flow. The remainder of the flow is the carryover. Note that the inlet opening is used much more efficiently for flow interception than the inlet illustrated in Figure 10-12.

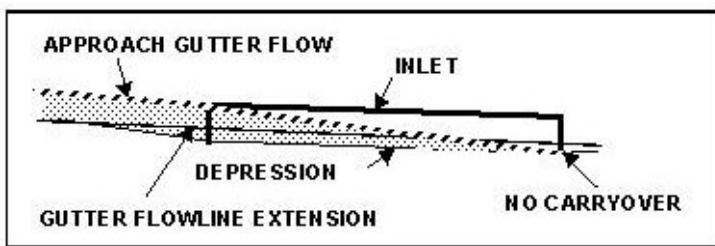

Figure 10-12. Inlet Designed with No Carryover

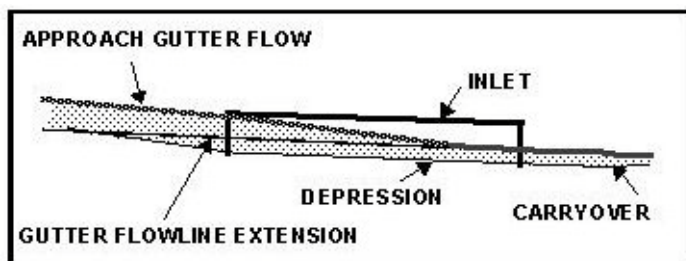

Figure 10-13. Inlet Designed with Carryover

You must accommodate any carryover rates by ultimate interception at some other location (sometimes termed “bypass flow”). Furthermore, the gutter between the two points must accommodate the additional carryover rate. Carryover is not recommended upstream of intersections and drive-ways, at super-elevation transitions where the cross slope begins to reverse, and below entrance/exit ramps.

Curb Inlets On-Grade

The design of on-grade curb opening inlets involves determination of length required for total flow interception, subjective decision about actual length to be provided, and determination of any resulting carryover rate.

For each on-grade inlet, determine early whether or not carryover is to be a valid design consideration. In some cases due to a logical location of the inlet, no carryover may be allowed. In other cases, while carryover is acceptable, there may not be a convenient location to accommodate the bypass flow.

Use the following procedure to design curb inlets on-grade:

1. Compute depth of flow and ponded width (T) in the gutter section at the inlet.
2. Determine the ratio of the width of flow in the depressed section (W) to the width of total gutter flow (T) using Equation 10-8. Figure 10-14 shows the gutter cross section at an inlet.

$$E_0 = \frac{K_w}{K_w + K_0}$$

Equation 10-8.

where:

E_0 = ratio of depression flow to total flow

K_w = conveyance of the depressed gutter section (cfs or m^3/s)

K_0 = conveyance of the gutter section beyond the depression (cfs or m^3/s).

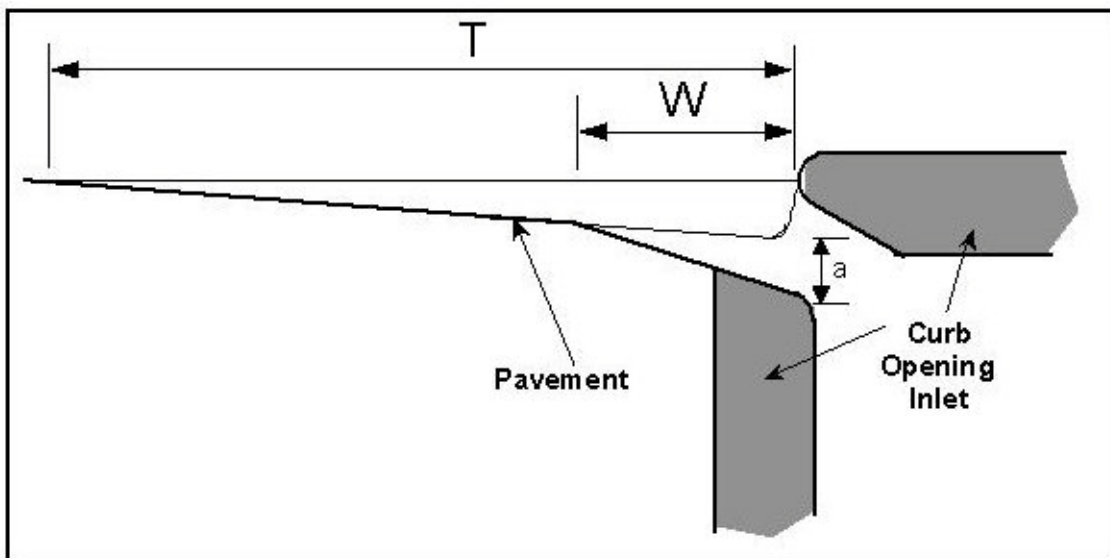

Figure 10-14. Gutter Cross-Section Diagram

Use Equation 10-9 to calculate conveyance, K_w and K_0 .

$$K = \frac{zA^{5/3}}{nP^{2/3}}$$

Equation 10-9.

where:

K = conveyance of cross section (cfs or m³/s)

z = 1.486 for English measurements and 1.0 for metric

A = area of cross section (sq.ft. or m²)

n = Manning's roughness coefficient

P = wetted perimeter (ft. or m).

Use Equation 10-10 to calculate the area of cross section in the depressed gutter section.

$$A_W = WS_x \left(T - \frac{W}{2} \right) + \frac{1}{2} aW$$

Equation 10-10.

where:

A_W = area of depressed gutter section (ft² or m²)

W = depression width for an on-grade curb inlet (ft. or m)

S_x = cross slope (ft./ft. or m/m)

T = calculated ponded width (ft. or m)

a = curb opening depression depth (ft. or m).

Use Equation 10-11 to calculate the wetted perimeter in the depressed gutter section.

$$P_W = \sqrt{[(WS_x + a)^2 + W^2]}$$

Equation 10-11.

where:

P_W = wetted perimeter of depressed gutter section (ft or m)

W = depression width for an on-grade curb inlet (ft. or m)

S_x = cross slope (ft./ft. or m/m)

a = curb opening depression depth (ft. or m).

Use Equation 10-12 to calculate the area of cross section of the gutter section beyond the depression.

$$A_0 = \frac{S_x}{2} (T - W)^2$$

Equation 10-12.

where:

A_0 = area of gutter/road section beyond the depression width (ft² or m²)

S_x = cross slope (ft./ft. or m/m)

W = depression width for an on-grade curb inlet (ft. or m)

T = calculated ponded width (ft. or m).

Use Equation 10-13 to calculate the wetted perimeter of the gutter section beyond the depression.

$$P_0 = T - W$$

Equation 10-13.

where:

P_0 = wetted perimeter of the depressed gutter section (ft or m)

T = calculated ponded width (ft. or m)

W = depression width for an on-grade curb inlet (ft. or m).

- Use Equation 10-14 to determine the equivalent cross slope (S_e) for a depressed curb opening inlet.

$$S_e = S_x + \frac{a}{W} E_o$$

Equation 10-14.

where:

S_e = equivalent cross slope (ft./ft. or m/m)

S_x = cross slope of the road (ft./ft. or m/m)

a = gutter depression depth (ft. or m)

W = gutter depression width (ft. or m)

E_o = ratio of depression flow to total flow.

- Calculate the length of curb inlet required for total interception using Equation 10-15.

$$L_r = z Q^{0.42} S^{0.3} \left(\frac{1}{n S_e} \right)^{0.6}$$

Equation 10-15.

where:

L_r = length of curb inlet required (ft. or m)

z = 0.6 for English measurement and 0.82 for metric

Q = flow rate in gutter (cfs or m³/s)

S = longitudinal slope (ft./ft. or m/m)

n = Manning's roughness coefficient

S_e = equivalent cross slope (ft./ft. or m/m).

If no carryover is allowed, the inlet length is assigned a nominal dimension of at least L_r . Use a nominal length available in standards for curb opening inlets. Do not use the exact value of L_r if doing so requires special details, special drawings and structural design, and costly and unfamiliar construction. If carryover is considered, round the curb opening inlet length down to the next available (nominal) standard curb opening length and compute the carryover flow.

- Determine carryover flow. In carryover computations, efficiency of flow interception varies with the ratio of actual length of curb opening inlet supplied (L_a) to length L_r and with the depression to depth of flow ratio. Use Equation 10-16 for determining carryover flow.

$$Q_{co} = Q \left(1 - \frac{L_a}{L_r} \right)^{1.8}$$

Equation 10-16.

where:

Q_{co} = carryover discharge (cfs or m³/s)

Q = total discharge (cfs or m³/s)

L_a = design length of the curb opening inlet (ft. or m)

L_r = length of curb opening inlet required to intercept the total flow (ft. or m).

Carryover rates usually should not exceed about 0.5 cfs (0.03 m³/s) or about 30% of the original discharge. Greater rates can be troublesome and cause a significant departure from the principles of the Rational Method application. In all cases, you must accommodate any carryover rate at some other specified point in the storm drain system.

6. Calculate the intercepted flow. Calculate the intercepted flow as the original discharge in the approach curb and gutter minus the amount of carryover flow.

Curb Inlets in Sag Configuration

The capacity of a curb inlet in a sag depends on the water depth at the curb opening and the height of the curb opening. The inlet operates as a weir to depths equal to the curb opening height and as an orifice at depths greater than 1.4 times the opening height. At depths between 1.0 and 1.4 times the opening height, flow is in a transition stage and the capacity should be based on the lesser of the computed weir and orifice capacity. Generally, for department design, this ratio should be less than 1.4 such that the inlet operates as a weir.

1. If the depth of flow in the gutter (d) is less than or equal to 1.4 times the inlet opening height (h), ($d \leq 1.4H$), determine the length of inlet required considering weir control. Otherwise, skip this step. Calculate the capacity of the inlet when operating under weir conditions with Equation 10-17.

$$Q = C_w (L + 1.8W) d^{1.5}$$

Equation 10-17.

Rearrange Equation 10-17 to produce the following relation for curb inlet length required.

$$L = \frac{Q}{C_w d^{1.5}} - 1.8W$$

Equation 10-18.

where:

Q = total flow reaching inlet (cfs or m³/s)

C_w = weir coefficient (ft.^{0.5}/s or m^{0.5}/s)

Suggested value = 2.3 ft.^{0.5}/s or 1.27 m^{0.5}/s. for depressed inlets

Suggested value = 3.0 ft.^{0.5}/s or 1.60 m^{0.5}/s without depression.

d = head at inlet opening (ft. or m), computed with Equation 10-1.

L = length of curb inlet opening (ft. or m)

W = gutter depression width (perpendicular to curb)

If $L > 12$ ft. (3.6m), then $W = 0$ and $C_w = 3.0$ ft.^{0.5}/s or 1.60 m^{0.5}/s.

2. If the depth of flow in the gutter is greater than the inlet opening height ($d > h$), determine the length of inlet required considering orifice control. The equation for interception capacity of a curb opening operating as an orifice follows:

$$Q = C_o h L \sqrt{2g d_o}$$

Equation 10-19.

where:

Q = total flow reaching inlet (cfs or m³/s)

C_o = orifice coefficient = 0.67

h = depth of opening (ft. or m) (this depth will vary slightly with the inlet detail used)

L = length of curb opening inlet (ft. or m)

g = acceleration due to gravity = 32.2. ft./s² or 9.81 m/s²

d_o = effective head at the centroid of the orifice (ft. or m).

For curb inlets with an inclined throat such as Type C inlet, the effective head, d_o , is at the centroid of the orifice. This changes Equation 10-19 to:

$$Q = C_o h L \sqrt{2g \left(y + a - \frac{h}{2} \sin \theta \right)}$$

where:

Q = total flow reaching inlet (cfs or m³/s)

C_o = orifice coefficient = 0.67

h = depth of opening (ft. or m) (this depth will vary slightly with the inlet detail used)

L = Length of curb opening inlet (ft. or m)

g = acceleration due to gravity = 32.2 ft/s² or 9.81 m/s²

y = depth of water in the curb and gutter cross section (ft. or m)

a = gutter depression depth (ft.).

Rearranging Equation 10-19 allows a direct solution for required length.

$$\frac{Q}{C_o h \sqrt{2g \left(y + a - \frac{h}{2} \sin \phi \right)}}$$

Equation 10-20.

3. If both steps 1 and 2 were performed (i.e., $h < d \leq 1.4h$), choose the larger of the two computed lengths as being the required length.
4. Select a standard inlet length that is greater than the required length.

Slotted Drain Inlet Design

Use the following procedure for on-grade slotted drain inlets:

1. Determine the length of slotted drain inlet required for interception of all of the water in the curb and gutter calculated by Equation 10-21.

$$L_r = \frac{z Q_a^{0.442} S^E S_x^{-0.849}}{n^{0.384}}$$

Equation 10-21.

where:

L_r = length of slotted drain inlet required for total interception of flow (ft. or m)

z = 0.706 for English measurement or 1.04 for metric

Q_a = total discharge (cfs or m^3/s)

S = gutter longitudinal slope (ft./ft. or m/m)

E = function of S and S_x as determined by Equation

S_x = transverse slope (ft./ft. or m/m)

n = Manning's roughness coefficient.

Equation 10-21 is limited to the following ranges of variables:

total discharge ≤ 5.5 cfs ($0.156 m^3/s$)

longitudinal gutter slope ≤ 0.09 ft./ft. (0.09 m/m)

roughness coefficient (n) in the curb and gutter: $0.011 \leq n \leq 0.017$.

$$E = 0.207 - 19.084S^2 + 2.613S - 0.0001S_x^{-2} + 0.007S_x^{-1} - 0.049SS_x^{-1}$$

Equation 10-22.

The longitudinal slope exponent (E) is determined with Equation 10-22:

Because the equations are empirical, extrapolation is not recommended.

2. Select the desired design slotted drain length (L_a) based on standard inlet sizes. If $L_a < L_r$ the interception capacity may be estimated using Figure 10-15, multiplying the resulting discharge

ratios by the total discharge. Alternatively, the carryover for a slotted drain inlet length may be directly computed using Equation 10-23.

$$Q_{co} = 0.918 Q \left(1 - \frac{L_a}{L_r} \right)^{1.769}$$

Equation 10-23.

where:

Q_{co} = carryover discharge (cfs or m³/s)

Q = total discharge (cfs or m³/s)

L_a = design length of slotted drain inlet (ft. or m)

L_r = length of slotted drain inlet required to intercept the total flow (ft. or m).

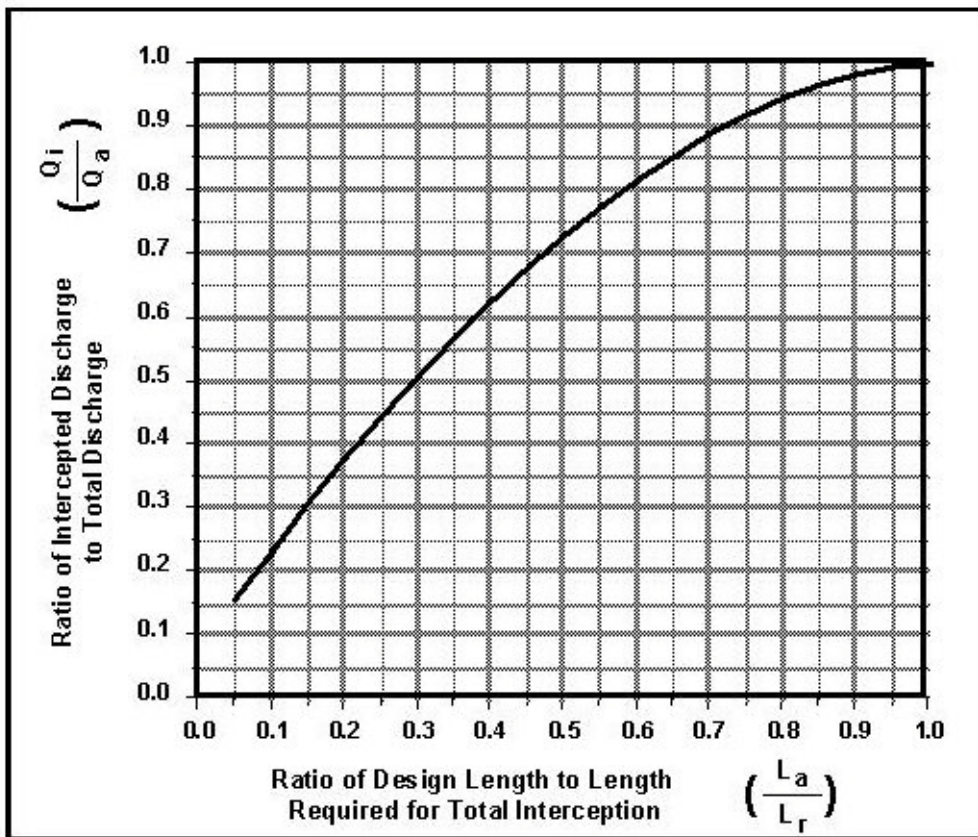

Figure 10-15. Slotted Drain Inlet Interception Rate

As a rule of thumb, you can optimize slotted drain inlets' economy by providing actual lengths (L_a) to required lengths (L_r) in an approximate ratio of about 0.65. This implies a usual design with carryover for on-grade slotted drain inlets.

Grate Inlets On-Grade

The capacity of a grate inlet on-grade depends on its geometry and cross slope, longitudinal slope, total gutter flow, depth of flow, and pavement roughness.

The depth of water next to the curb is the major factor affecting the interception capacity of grate inlets. At low velocities, all of the water flowing in the section of gutter occupied by the grate, called frontal flow, is intercepted by grate inlets, and a small portion of the flow along the length of the grate, termed side flow, is intercepted. On steep slopes, only a portion of the frontal flow will be intercepted if the velocity is high or the grate is short and splash-over occurs. For grates less than 2 ft. (0.6 m) long, intercepted flow is small. Agencies and manufacturers of grates have investigated inlet interception capacity. For inlet efficiency data for various sizes and shapes of grates, refer to HEC-12.

Bicycle Safety for Grate Inlets On-Grade

A parallel bar grate is the most efficient type of gutter inlet; however, when crossbars are added for bicycle safety, the efficiency is reduced. Where bicycle traffic is a design consideration, the curved vane grate and the tilt bar grate are recommended for both their hydraulic capacity and bicycle safety features. In certain locations where leaves may create constant maintenance problems, the parallel bar grate may be used more efficiently if bicycle traffic is prohibited.

Design Procedure for Grate Inlets On-Grade

Use the following procedure for grate inlets on-grade:

1. Compute the ponded width of flow (T). Use the outline provided in Section 4 ([Gutter Ponding Procedure for Continuous Grades](#)).
2. Choose a grate type and size.
3. Find the ratio of frontal flow to total gutter flow (E_o) for a straight cross-slope using [Equation 10-8](#). No depression is applied to a grate on-grade inlet.
4. Find the ratio of frontal flow intercepted to total frontal flow, R_f , using Equation 10-24, Equation 10-25, and Equation 10-26.

$$R_f = 1 - 0.3(v - v_o), \text{ if } v > v_o$$

Equation 10-24.

$$R_f = 1.0, \text{ if } v < v_o$$

Equation 10-25.

where:

R_f = ratio of frontal flow intercepted to total frontal flow

v = approach velocity of flow in gutter (ft./s or m/s)

v_o = minimum velocity that will cause splash over grate (ft./s or m/s).

For triangular sections, calculate the approach velocity of flow in gutter (v) using Equation 10-25.

$$v = \frac{2Q}{Ty} = \frac{2Q}{T^2 S_x}$$

Equation 10-26.

Otherwise, compute the section area of flow (A) and calculate the velocity using Equation 10-25:

$$v = \frac{Q}{A}$$

Equation 10-27.

Calculate the minimum velocity (v_o) that will cause splash over the grate using the appropriate equation in tables below.

where:

v_o = splash-over velocity (ft./s or m/s)

L = length of grate (ft. or m)

Splash-Over Velocity Calculation Equations (English)

Grate Configuration	Typical Bar Spacing (in.)	Splash-over Velocity Equation
Parallel Bars	2	$v_o = 2.218 + 4.031L - 0.649L^2 + 0.056L^3$
Parallel Bars	1.2	$v_o = 1.762 + 3.117L - 0.451L^2 + 0.033L^3$
Transverse Curved Vane	4.5	$v_o = 1.381 + 2.78L - 0.300L^2 + 0.020L^3$
Transverse 45° Tilted Vane	4	$v_o = 0.988 + 2.625L - 0.359L^2 + 0.029L^3$
Parallel bars w/ transverse rods	2 parallel/4 trans	$v_o = 0.735 + 2.437L - 0.265L^2 + 0.018L^3$
Transverse 30° Tilted Vane	4	$v_o = 0.505 + 2.344L - 0.200L^2 + 0.014L^3$
Reticuline	n/a	$v_o = 0.030 + 2.278L - 0.179L^2 + 0.010L^3$

Splash-Over Velocity Calculation Equations (Metric)

Grate Configuration	Typical Bar Spacing (mm)	Splash-over Velocity Equation
Parallel Bars	50	$v_o = 0.676 + 4.031L - 2.13L^2 + 0.598L^3$
Parallel Bars	30	$v_o = 0.537 + 3.117L - 1.478L^2 + 0.358L^3$

Splash-Over Velocity Calculation Equations (Metric)

Grate Configuration	Typical Bar Spacing (mm)	Splash-over Velocity Equation
Transverse Curved Vane	115	$v_o = 0.421 + 2.78L - 0.984L^2 + 0.215L^3$
Transverse 45° Tilted Vane	100	$v_o = 0.301 + 2.625L - 1.177L^2 + 0.311L^3$
Parallel bars w/ transverse rods	50 parallel/100 trans	$v_o = 0.224 + 2.437L - 0.869L^2 + 0.192L^3$
Transverse 30° Tilted Vane	100	$v_o = 0.154 + 2.344L - 0.656L^2 + 0.155L^3$
Reticuline	n/a	$v_o = 0.009 + 2.278L - 0.587L^2 + 0.108L^3$

5. Find the ratio of side flow intercepted to total side flow, R_s .

$$R_s = \left[1 + \frac{zv^{1.8}}{S_x L^{2.3}} \right]^{-1}$$

Equation 10-28.

where:

R_s = ratio of side flow intercepted to total flow

$z = 0.15$ for English measurement or 0.083 for metric

S_x = transverse slope

v = approach velocity of flow in gutter (ft./s or m/s)

L = length of grate (ft. or m).

6. Determine the efficiency of grate, E_f . Use Equation 10-29.

$$E_f = [R_f E_o + R_s (1 - E_o)]$$

Equation 10-29.

7. Calculate the interception capacity of the grate, Q_i . Use Equation 10-30. If the interception capacity is greater than the design discharge, skip step 8.

$$Q_i = E_f Q = Q [R_f E_o + R_s (1 - E_o)]$$

Equation 10-30.

8. Determine the carryover, CO. Use Equation 10-31.

$$CO = Q - Q_i$$

Equation 10-31.

9. Depending on the carryover, select a larger or smaller inlet as needed. If the carryover is excessive, select a larger configuration of inlet and return to step 3. If the interception capacity far exceeds the design discharge, consider using a smaller inlet and return to step 3.

Design Procedure for Grate Inlets in Sag Configurations

A grate inlet in sag configuration operates in weir flow at low ponding depths. A transition to orifice flow begins as the ponded depth increases. Use the following procedure for calculating the inlet capacity:

1. Choose a grate of standard dimensions to use as a basis for calculations.
2. Determine an allowable head (h) for the inlet location. This should be the lower of the curb height and the depth associated with the allowable ponded width. No gutter depression is applied at grate inlets.
3. Determine the capacity of a grate inlet operating as a weir. Under weir conditions, the grate perimeter controls the capacity. Figure 10-16 shows the perimeter length for a grate inlet located next to and away from a curb. The capacity of a grate inlet operating as a weir is determined using Equation 10-32.

$$Q_w = C_w P^{1.5}$$

Equation 10-32.

where:

Q_w = weir capacity of grate (cfs or m³/s)

C_w = weir coefficient = 3 for English measurement or 1.66 for metric

P = perimeter of the grate (ft. or m) as shown in Figure 10-16: A multiplier of about 0.5 is recommended to be applied to the measured perimeter as a safety factor.

h = allowable head on grate (ft. or m).

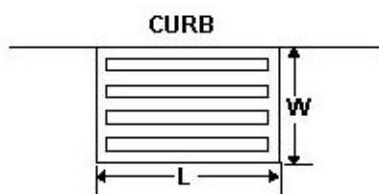

$P=2(W - \text{width of bars}) + L \text{ (with curb)}$ $P=2(W+L - \text{bars}) \text{ (without curb)}$ $A=WL - \text{area of bars}$
--

Figure 10-16. Perimeter Length for Grate Inlet in Sag Configuration

4. Determine the capacity of a grate inlet operating under orifice flow. Under orifice conditions, the grate area controls the capacity. The capacity of a grate inlet operating under orifice flow is computed with Equation 10-33.

$$Q_o = C_o A \sqrt{2gh}$$

Equation 10-33.

where:

Q_o = orifice capacity of grate (cfs or m³/s)

C_o = orifice flow coefficient = 0.67

A = clear opening area (sq. ft. or m²) of the grate (the total area available for flow). A multiplier of about 0.5 is recommended to be applied to the measured area as a safety factor

g = acceleration due to gravity (32.2 ft/s² or 9.81 m/s²)

h = allowable head on grate (ft. or m).

5. Compare the calculated capacities from steps 3 and 4 and choose the lower value as the design capacity. The design capacity of a grated inlet in a sag is based on the minimum flow calculated from weir and orifice conditions. Figure 10-17 demonstrates the relationship between weir and orifice flow. If Q_o is greater than Q_w (to the left of the intersection in Figure 10-17), then the designer would use the capacity calculated with the weir equation. If, however, Q_o is less than Q_w (to the right of the intersection), then the capacity as determined with the orifice equation would be used.

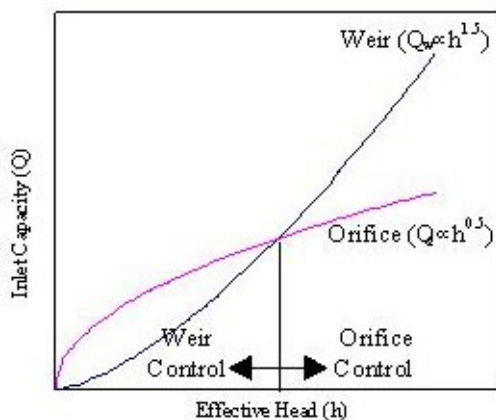

Figure 10-17. Relationship between Head and Capacity for Weir and Orifice Flow

Section 6 — Conduit Systems

Conduits

The storm drainage conduit system transports the runoff from the surface collection system (inlets) to the outfall. Although it is an integral component, analyze the conduit system independently of the inlet system.

An inlet location in a storm drain system basically controls the need for a conduit, its slope and horizontal orientation, and its minimum cover requirements.

The configuration of laterals and trunk lines is controlled by the locations of all inlet and roadway layouts and is also affected by utility and foundation locations.

The longitudinal slope of the conduit affects its capacity. The slope of the subject run is tentatively established during the system planning stage of design. Typically, the slope will be approximately parallel to the surface topography. However, you may have to adjust conduit slopes to adapt to critical elevations (such as outfall elevations). You can adjust individual run slopes as necessary to increase capacity, avoid conflicts with utilities, and afford adequate cover for the conduit.

Avoid circular pipe sizes less than 18 in. (450 mm) diameter for main trunk lines or laterals because of difficulties in their construction and maintenance. Some designers prefer to limit the minimum circular diameter to 24 in. (600 mm). Consider the following recommendations on conduit dimensions:

- ◆ Standard size pipe use in conduits -- Do not use non-standard sizes of pipe. It is rarely cost effective to specify pipe dimensions requiring special fabrication. Consult with local fabricators, become acquainted with stockpiled dimensions, and use those commonly manufactured sizes in the design.
- ◆ Larger versus smaller conduit dimensions -- Avoid discharging the flow of a larger conduit into a smaller one. The capacity of the smaller conduit may technically be greater due to a steeper slope. However, a reduction in size almost always results in operational problems and expenses for the system. Debris that may pass through a larger dimension may clog as it enters a smaller dimension.
- ◆ Soffit and flow line placement in conduits -- At changes in size of conduit, make an attempt to place the soffits (top inside surfaces) of the two conduits at the same level rather than placing the flow lines at the same level. Where flow lines are placed at the same level, the smaller pipe often must discharge against a head. It may not be feasible to follow this guideline in every instance, but it should be the rule whenever practicable.
- ◆ Conduit length -- You may approximate the length of the conduit for these calculations. Often, the length is indicated as from centerline-to-centerline of the upstream and downstream nodes

of the subject conduit run. Use the length with the average flow velocity to estimate the travel time within the subject run. Establish the length of the run during the first phase of the storm drain system design in which the inlets are located.

NOTE: These are not pay lengths of conduit; the standard specifications provide that pay lengths include only the actual net length of pipe and not the distance across inlets or manholes where no conduit actually is placed.

Manholes

Place manholes or combination manholes and inlets wherever necessary for clean-out and inspection purposes. It is good engineering practice to place manholes at changes in direction, junctions of pipe runs, and intervals in long pipe runs where the size or direction may not have changed. The table below provides recommended maximum spacing criteria for manholes.

Manholes Spacing Criteria

Pipe Diameter		Maximum Distance	
in.	mm	ft.	m
12 – 24	300 - 600	300	100
27 – 36	675 – 900	375	120
39 – 54	1050 – 1350	450	150
=>60	=> 1500	900	300

Round the invert (bottom) of the manhole section to match the inverts of the pipes attached to the manhole to minimize eddying and resultant head losses. For manholes larger than the incoming or outgoing pipes, expansion losses can sometimes be significant.

Detail manholes that are intended as combinations with other functions to include facilities that will serve all the intended functions. In such cases, you may need to consider junction losses.

At junctions of pipelines, right angle intersections are simpler to construct. However, an acute angle junction reduces head losses, and you should consider it where practical. See Figure 10-18 for the contrast. Where junction losses may be of particular concern, consider using acute angle junctions.

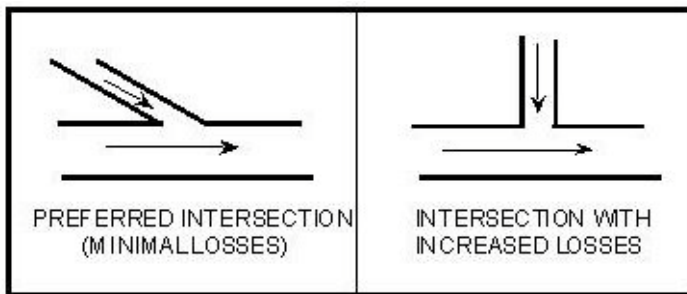

Figure 10-18. Head Losses at Intersections

Inverted Siphons

Inverted siphons carry flow under obstructions such as sanitary sewers, water mains, or any other structure or utility that may be in the path of the storm drain line. Use them only where avoidance or adjustment of the utility is not practical. The storm drain flowline is lowered at an obstacle and is raised again after the crossing. In the design of inverted siphons, we recommend a minimum flow velocity of 3 fps (1 m/s).

In general, the conduit size through the inverted siphon used as a storm drain system should be the same size as either the approaching or exiting conduit. In no case should the size be smaller than the smallest of the approaching or exiting conduit.

Because an inverted siphon includes slopes of zero and adverse values, account for head losses through the structure using outlines in Chapter 6, [Hydraulic Grade Line Analysis](#). The sources of these losses can be friction, bends, junctions, and transitions.

If the losses are unacceptable, you may need alternative means of avoiding the utility conflict. Provide maintenance access at either or both ends of the inverted siphon as indicated in Figure 10-19.

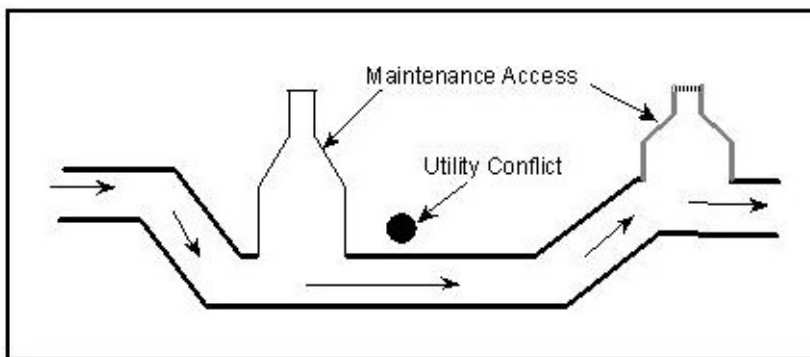

Figure 10-19. Inverted Siphon

Conduit Capacity Equations

Refer to Chapter 6 for calculating channel (conduit) capacity and critical depth.

Conduit Design Procedure

In this procedure, nodes represent point definitions in the network such as junctions and inlets. Runs represent the conduit connections between nodes. A storm drainage system is characterized as a link-node system with runoff entering the system at nodes (inlets) that are linked together (by pipe or conduit runs), all leading to some outfall (outlet node). The procedure entails proceeding progressively downstream from the most remote upstream node to the outlet. The peak discharge at each node is re-computed based on cumulative drainage area, runoff coefficient, and longest time of concentration contributing to the particular node.

Use the following steps for the design of conduit systems:

1. Determine the design discharge at each extreme node (inlet). The design discharge for a particular run is based on the watershed area to the upstream node of the run, the associated weighted runoff coefficient, and the rainfall intensity based on the time of concentration (t_c) in the watershed. This time of concentration often is referred to as “inlet time,” indicating it is the surface time of concentration in the watershed to the inlet. If the t_c is less than 10 minutes, base the intensity on a t_c of 10 minutes; otherwise, use the actual t_c value. Use this value of t_c in Equation 10-35 for rainfall intensity and compute the discharge using Equation 10-34. Account for the actual time of concentration as this value eventually may become significant even if it is less than 10 minutes.

$$Q = \frac{CIA}{z}$$

Equation 10-34.

where:

Q = peak discharge (cfs or m^3/s)

C = runoff coefficient

I = rainfall intensity associated with a specific frequency (in./hr or mm/hr)

A = area of the watershed (ac. or ha)

z = 1.0 for English measurement and 360 for metric.

$$I_f = \frac{b}{(t_c + d)^e}$$

Equation 10-35.

where:

I_f = rainfall intensity for frequency (mm/hr)

t_c = time of concentration (min)

e , b , d = empirical factors that are tabulated for each county in Texas for frequencies of 2, 5, 10, 25, 50, and 100 years in [Hydrology](#). (See [Rainfall Intensity-Duration-Frequency Coefficients](#).)

If the inlet has been designed with carryover, either from or to the inlet, ignore the carryover rate(s) when considering the discharge into the conduit.

Base the intensity on the longest time of concentration leading to the upstream end of the run. This means that a recalculation of total discharge is necessary at each upstream end of a conduit run. It also means that you do not simply add discharge rates from approaching watersheds and/or pipe runs; rather, multiply the sum of contributing CA values by an intensity based on the longest time of concentration leading to the point in question.

2. Size the conduit for pressure flow or for non-pressure flow based on Manning's Equation and the design discharge. The recommended method is to design for non-pressure flow: conduit size will likely be slightly larger than necessary to accommodate the design flow under the terms of Manning's Equation. For TxDOT, pressure flow design means that the conduit has dimensions smaller than necessary to accommodate the design flow under the terms of Manning's Equation. If it is necessary or useful to design conduits for pressure flow, coordinate such design with the Design Division, Hydraulic Branch. To size circular pipe, use Equation 10-36 (depending on material type and associated roughness):

$$D = z \left(\frac{Qn}{S^{1/2}} \right)^{3/8}$$

Equation 10-36.

where:

D = required diameter (ft. or m)

z = 1.3333 for English measurement or 1.5485 for metric

Q = discharge (cfs or m³/s)

n = Manning's roughness coefficient

S = slope of conduit run (ft./ft. or m/m).

For sizing other shapes, use trial and error: select a trial size and compute the capacity. Adjust the size until the computed capacity is slightly higher than the design discharge.

3. Estimate the velocity of flow through the designed conduit. Assume uniform flow as an average depth of flow in the conduit as discussed in Section 2 of Chapter 6. Determine the cross-section area, A_u , at this depth. This is a straightforward procedure for rectangular sections but much more complicated for circular and other shapes. Manufacturers' product information may include tables of depth, area, and wetted perimeter. If not, calculate area and wetted perimeter based on the geometry of the conduit. Then calculate the average velocity of flow (V_a) using the continuity relation shown in Equation 10-37.

$$V_a = \frac{Q}{A_u}$$

Equation 10-37.

4. Calculate the travel time for flow in the conduit from the upstream inlet/node to the downstream node by dividing the length of the conduit by the average velocity of flow. Add this travel time to the time of concentration at the upstream end of the subject run to represent the time of concentration at the downstream end of the run.

NOTE: When accumulating times, base the time of concentration on the actual calculated times, even if it is less than the minimum of 10 minutes.

5. Determine the total drainage area, cumulative runoff coefficient times area, and respective time of concentration. As you complete the design of the most remote runs and the design proceeds downstream through the system, determine the total drainage area, cumulative runoff coefficient times area, and respective time of concentration for all conduits incoming at a particular node before sizing the conduit run out of that node.
6. Compute the peak discharge for the next run downstream based on the total drainage area upstream contributing to each incoming conduit/run at the node, the cumulative product of the runoff coefficient and contributing area to each incoming conduit/run at the node, the longest time of concentration of all incoming conduits, and, if applicable, inlet time for the node. (This time is used to re-compute intensity in the rational equation for sizing the next downstream conduit run).

NOTE: You can easily determine the area and runoff coefficient if you record the CA values for each watershed as you proceed with design down the system and sum them at each node.

7. Continue this process until you have sized all conduits in the network. In each case, as runs and entering watersheds converge to a node, recalculate the peak discharge for which the exiting conduit is to be designed as the product of an intensity based on the longest time of concentration leading into the node and a summation of all CA values that contribute flow to the node. The discharge, so determined, is not the same as if you have added all approaching discharges because the procedure is fashioned to conform to the general application requirements for the Rational Method. In some instances, calculated discharges can decrease as you carry the analysis downstream (because of a small increase in the accumulated CA as compared to rainfall intensity). In such cases, use the previous intensity to avoid designing for a reduced discharge or consider using a hydrograph routing method.
8. Develop the hydraulic grade line (HGL) in the system as outlined in [Chapter 6](#). Calculate minor losses according to [Chapter 10](#).

Conduit Analysis

The analysis of a conduit requires the same consideration of hydrology as does design. The difference is that geometry, roughness characteristics, and conduit slopes are already established.

The analysis and accumulation of discharge must proceed from upstream toward downstream in the system. Develop the discharges in this way so that appropriate discharge values are available for the development of the [hydraulic grade line analysis](#).

Section 7 — Conduit Systems Energy Losses

Minor Energy Loss Attributions

Major losses result from friction within the pipe. Minor losses include those attributed to junctions, exits, bends in pipes, manholes, expansion and contraction, and appurtenances such as valves and meters.

Minor losses in a storm drain system are usually insignificant. In a large system, however, their combined effect may be significant. Methods are available to estimate these minor losses if they appear to be cumulatively important. You may minimize the hydraulic loss potential of storm drain system features such as junctions, bends, manholes, and confluences to some extent by careful design. For example, you can replace severe bends by gradual curves in the pipe run where right-of-way is sufficient and increased costs are manageable. Well designed manholes and inlets, where there are no sharp or sudden transitions or impediments to the flow, cause virtually no significant losses.

Junction Loss Equation

For adjoining pipes to be considered a pipe junction, the node and only two inflow pipes (a lateral and a trunk) may enter the junction. The minor loss equation for a pipe junction is in the form of the momentum equation. In Equation 10-38 the subscripts “i”, “o”, and “l” indicate the inlet, outlet, and lateral, respectively.

$$h_j = \frac{Q_o v_o - Q_i v_i - Q_l v_l \cos \theta}{0.5g(A_o + A_l)}$$

Equation 10-38.

where:

h_j = junction head loss (ft. or m)

Q = flow (cfs or m³/s)

v = velocity (fps or m/s)

A = cross-sectional area (sq. ft. or m²)

θ = angle in degrees of lateral with respect to centerline of outlet pipe

g = gravitational acceleration = 32.2 ft/s² or 9.81 m/s².

The above equation applies only if $v_o > v_i$ and assumes that $Q_o = Q_i + Q_l$.

Exit Loss Equation

The exit loss, h_o , is a function of the change in velocity at the outlet of the pipe as shown in Equation 10-39.

$$h_o = C_o \frac{v^2 - v_d^2}{2g}$$

Equation 10-39.

where:

v = average outlet velocity (fps or m/s)

v_d = channel velocity downstream of the outlet (fps or m/s)

C_o = exit loss coefficient (0.5 typical).

The above assumes that the channel velocity is lower than the outlet velocity

Manhole Loss Equations

Calculate the loss from one pipe to another through a manhole using Equation 10-40.

$$h = K \frac{v_o^2}{2g}$$

Equation 10-40.

where the adjusted head loss coefficient (K) is found with Equation 10-41.

$$K = K_o C_D C_d C_Q C_P C_B$$

Equation 10-41.

where:

K_o = initial head loss coefficient based on relative manhole size

C_D = correction factor for pipe diameter

C_d = correction factor for flow depth

C_Q = correction factor for relative flow

C_B = correction factor for benching

C_P = correction factor for plunging flow.

The initial head loss coefficient (K_o) is estimated as a function of the relative manhole size and angle between the inflow and outflow pipes.

$$K_o = 0.1 \left[\frac{b}{D_o} \right] [1 - \sin \theta] + 1.4 \left[\frac{b}{D_o} \right]^{0.15} \sin \theta$$

Equation 10-42.

where:

K_o = initial head loss coefficient based on relative manhole size

θ = angle between the inflow and outflow pipes (see Figure 10-20)

b = manhole diameter or width (ft. or m)

D_o = outlet pipe diameter (ft. or m).

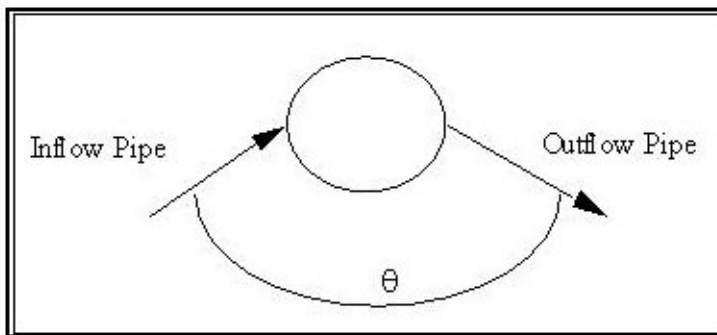

Figure 10-20. Angle Between Inflow and Outflow Pipes

The correction factor for pipe diameter, C_D , can be determined by the following:

$$C_D = \left[\frac{D_o}{D_i} \right]^3$$

Equation 10-43.

where:

C_D = correction factor for variation in pipe diameter

D_i = incoming pipe diameter (ft. or m)

D_o = outgoing pipe diameter (ft. or m).

A change in head loss due to differences in pipe diameter is significant only in pressure flow situations when the depth in the manhole to outlet pipe diameter ratio, d/D_o , is greater than 3.2.

Therefore, only apply it in such cases; otherwise, use $C_D = 1$.

Calculate the correction factor for flow depth, C_d , using Equation 10-44.

$$C_d = 0.5 \left[\frac{d}{D_o} \right]^{3/5}$$

where:

C_d = correction factor for flow depth

d = water depth in manhole **above outlet pipe invert** (ft. or m)

D_O = outlet pipe diameter (ft. or m).

This correction factor is significant only in cases of free surface flow or low pressures, when d/D_O ratio is less than 3.2. Water depth in the manhole is approximated as the level of the hydraulic grade line at the upstream end of the outlet pipe.

Compute the correction factor for relative flow, C_Q , using Equation 10-45.

$$C_Q = (1 - 2 \sin \theta) \left[1 - \frac{Q_i}{Q_o} \right]^{3/4} + 1$$

Equation 10-44.

where:

C_Q = correction factor for relative flow

θ = angle between the inflow and outflow pipes

Q_i = flow in the incoming pipe (cfs or m^3/s)

Q_O = flow in the outlet pipe (cfs or m^3/s)

C_Q = a function of the angle of the incoming flow as well as the percentage of flow coming in through the pipe of interest versus other incoming pipes.

To illustrate this effect, consider the following example (see Figure 10-21):

$$Q_1 = 0.3 \text{ m}^3/\text{s}$$

$$Q_2 = 0.1 \text{ m}^3/\text{s}$$

$$Q_3 = 0.4 \text{ m}^3/\text{s}$$

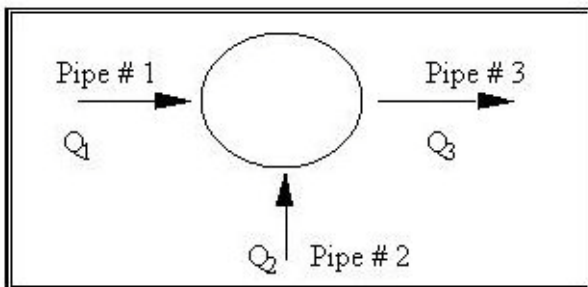

Figure 10-21. Example of Correction Factor for Relative Flow

Solving for the relative flow correction factor in going from the outlet pipe (number 3) to one of the inflow pipes (number 2):

$$C_{Q_{3-2}} = \left[1 - 2 \sin(90^\circ) \right] \left[1 - \frac{0.1}{0.4} \right]^{3/4} + 1 = 0.19$$

Equation 10-45.

For a second example, consider the following flow regime:

$$Q_1 = 1 \text{ cfs}$$

$$Q_2 = 3 \text{ cfs}$$

$$Q_3 = 4 \text{ cfs}$$

Calculating C_Q for this case:

$$C_{Q_{3-2}} = \left[1 - 2 \sin(90^\circ) \right] \left[1 - \frac{0.3}{0.4} \right]^{3/4} + 1 = 0.65$$

Equation 10-46.

In both of these cases, the flow coming in through pipe number 2 has to make a 90-degree bend before it can go out pipe number 3. In case 1, the larger flow traveling straight through the manhole from pipe number 1 to pipe number 3 assists the flow from pipe number 2 in making this bend. In case 2, a majority of the flow is coming in through pipe number 2. There is less assistance from the straight through flow in directing the flow from pipe number 2 into pipe number 3. As a result, the correction factor for relative flow in case 1 (0.19) is much smaller than the correction factor for case 2 (0.65).

The correction factor for plunging flow, C_p , is calculated using Equation Equation 10-48.

$$C_p = 1 + 0.2 \left[\frac{h}{D_o} \right] \left[\frac{h-d}{D_o} \right]$$

Equation 10-47.

where:

C_p = correction for plunging flow

h = vertical distance of plunging flow from the center of the outlet pipe (ft. or m)

D_o = outlet pipe diameter (ft. or m)

d = water depth in the manhole (ft. or m).

This correction factor corresponds to the effect of another inflow pipe plunging into the manhole on the inflow pipe for which the head loss is being calculated. Using the notations in Figure 10-21, for example, calculate C_p for pipe number 2 when pipe number 1 discharges plunging flow. Consider

the plunging flow that results from flow entering through the inlet into the manhole in the same manner. Only apply the correction factor when h is greater than d .

The table below presents correction factors for benching, C_B . Benching refers to how the conduit is placed with respect to the manhole as follows:

- ◆ Depressed floor -- The manhole bottom is lower than the storm drain conduit.
- ◆ Flat floor -- The manhole bottom is flush with the storm drain conduit.
- ◆ Half bench -- The bottom of the manhole is grouted or shaped to match up with the bottom half of the conduit.
- ◆ Full bench -- The bottom of the manhole is grouted or shaped to the top of the storm drain conduit.

Correction Factor for Benching

-	Correction Factor, C_B	
	Pressure Flow ($d/D_O > 3.2$)*	Free Surface Flow ($d/D_O < 1.0$)*
Bench Type		
Flat or Depressed Floor	1.0	1.0
Half Bench	0.95	0.15
Full Bench	0.75	0.07
* If $1.0 < d/D_O < 3.2$, use linear interpolation between pressure flow and free surface flow coefficients.		

Chapter 11 — Pump Stations

Contents:

[Section 1 — Introduction](#)

[Section 2 — Pump Station Components](#)

[Section 3 — Pump Station Hydrology](#)

[Section 4 — Pump Station Hydraulic Design Procedure](#)

Section 1 — Introduction

Purpose of A Pump Station

A pump station mechanically lifts storm water runoff from a gravity fed collection cistern to a discharge place or outfall. In general, gravity outfalls are the primary and preferred means of releasing flow from storm drain systems. However, a pump station becomes necessary when gravity outfalls are not economically or engineeringly feasible.

The need for pump stations is a function of the highway geometric design rather than of climatic factors. Planners can design pump stations to be unobtrusive, efficient, and reliable.

In the planning stages, the roadway designer can obtain valuable advice and assistance from the following sources:

- ◆ manufacturer representatives for pumps,
- ◆ manufacturer representatives for generators,
- ◆ contractors who have had experience in pump station construction,
- ◆ utility representatives for electricity and natural gas.

Security and Access Considerations

Protection of the facilities is an important concern. The pump station facility should be protected and secured with fences, gates, and locks. When planning the fencing, adequate access for service and maintenance vehicles must be provided.

Safety and Environmental Considerations

Depending on the types and concentrations of runoff contaminants or pollutants that may be pumped by the facility, certain safety and environmental features may be necessary in the design. Consult the Design Division's Hydraulics Branch about the quality of the runoff discharge water. Refer to the TxDOT [Environmental](#) Manual and the Environmental Division for more information on environmental concerns, policies, and agencies.

Section 2 — Pump Station Components

Overview of Components

A full discussion of the design and specification of a pump station is beyond the scope of this manual. However, this section attempts to bring to the design engineer's attention the various components and the considerations for those components. Appropriate design specialists for the control, electrical, mechanical, and structural components of a pump station must be consulted early in the decision process. A common reference for design of pump stations is FHWA Hydraulic Engineering Circular number 24 ([HEC-24](#)).

The following are necessary considerations in pump station design:

- ◆ Property-An entire pump station generally requires more footprint than merely the pumps and wet well or sump. Other necessary parts of the station include the electrical service, system controller, motor control center cabinets, which must be in a separate, dry room, and standby power generation. Other considerations may be on-site storage and parking. A required consideration is maintenance access to the pumps and the standby generator; not just personnel access, but the ability and room to bring in suitable vehicles and equipment such as a boom crane to lift out pumps, generator, and electrical cabinets for repair or replacement.
- ◆ Arrangement-The wells and pumps may not need to be in the same place as the control house. An example of this is a set of wells with submerged pumps and discharge conduits located in a wide median of a depressed section of Interstate highway. The control house with the electrical service, standby generator, motor control center, and control circuitry is located along the frontage road out of the depressed section and away from buried or overhead utilities.
- ◆ Wet Well- The wet well receives the inflow of storm water prior to pumping. It must also be designed with a trash collection rack, room for sedimentation collection without diminishing the design capacity, and a sump pump to remove the bottom storage below the main pump level.
- ◆ Electrical-The appropriate electrical service for a pump station is usually 277/480-volt, 3-phase AC. For a typical pump station, the electrical service equipment includes large metal cabinets for the electrical metering, main circuit breaker, a transfer switch to isolate the station from the utility when the standby generator is powering the station, and the electrical distribution panel. The details of the electrical service equipment are the province of the electrical engineer. However, the project manager must understand that clearances and air space around electrical equipment are not options; they are mandatory safety requirements which may increase the footprint of the pump station, but cannot be ignored.
- ◆ Standby Power-The normal source of standby power is either a diesel or natural gas engine/generator set. Fuel cells are not suitable for pump stations because of the hours long start-up time they require. Battery technology is improving to the point where solar or wind power

may become viable. For TxDOT pump stations, natural gas powered engines should be considered over diesel. Diesel is the more efficient fuel which allows for a smaller engine than natural gas, but diesel has many other problems. Modern diesel is intended to be used within a few months of production. Diesel fuel that sits in a holding tank for a long period is at risk of gelling, particularly if the fuel is warmed during the monthly or weekly scheduled test run of the unit. Sitting diesel fuel is also highly subject to moisture contamination from the atmosphere. Natural gas is not subject to contamination or breakdown in the pipeline. Destructive storms which may cause road blockages and delivery problems usually do not interfere with natural gas service.

- ◆ Pumps-Pump selection depends on station layout, required pump rate, wet well depth, and pump maintenance considerations. Pump selection includes the size, type, and number of pumps. For the most part, department pump stations use vertical propeller and submersible pumps. Pump sizes are usually selected to use multiple pumps rather than a single pump of appropriate size. Smaller pumps are usually less expensive to buy and operate, and with multiple pumps the loss of one will not shut down the entire pump station. A single, large pump is more likely to have long term maintenance problems from the frequent start up required to handle flows from smaller events. The sump pump is a much smaller pump, usually designed to handle small amounts of trash or debris loading without failing.
- ◆ Motors-Pump motors for department pump stations are usually 480-volt, three-phase electric motors. However, the specific voltage selected depends on the power available from the utility and on what pump-motor combinations are commercially available. The size of each motor depends on the pump size, flow rate, pressure head, and duty cycle. The hydraulic engineer specifying the pumps must work together with the electrical engineer specifying the motors and the control system to insure compatibility of components.
- ◆ Control and Communication Systems-The control system for a pump station is more than the sensor and circuitry to activate the pumps when the water in the wet well reaches a predetermined height. The control system includes a large cabinet for the motor control center (MCC) to operate and protect all the motors in the station, separate cabinets for the variable frequency drives (VFD) for the pump motors or any motor that may be expected to operate at less than full speed, and a separate cabinet for the programmable logic controller (PLC). [NOTE: A traffic signal controller is a specialized PLC.] The PLC monitors all signals and controls the sequence of operation of the pumps, activation of the standby generator when necessary, deactivation when the flood event has passed, and operation of any night security lighting. The PLC may also include automatic communication with the District and/or Maintenance Office to report the station's status regarding water levels, pump readiness, utility electrical power status, standby generator battery status, fuel status, security, and other central office concerns. The PLC can be integrated with the ITS to warn motorists of water over the roadway in the event of extreme rain events that exceed the capacity of the pump station. The design of the controls and communications is also the province of the electrical designer. However, the design is dependent on the input information from the hydraulic designer such as wet well

capacity, allowed pump discharge rate, desired pump discharge rate, and specific communications.

- ◆ Control Board-The pump station should have a central control board for starting or stopping some processes and verifying the various components' conditions, whether "running", "standby", or "off". In addition, although the station may be operated by a control system (PLC or other), a manual override for each component is highly recommended for maintenance and testing. This must be designed by the electrical engineer with input from TxDOT maintenance personnel.
- ◆ Structures-The structure must meet requirements for public safety, safety codes, local extreme weather conditions, site security, and maintenance operations. Maintenance requirements may be oversized doors to move equipment in and out or a movable roof to allow crane access. Aesthetics and the possibility of future expansion should also be considered.
- ◆ Discharge Conduits-The collected waters are usually discharged to a storm drain system, although sometimes the discharge point is a wetland, mud flat, or creek. The designer must consider whether the receiving location is suitable for the anticipated pump rate, whether it is available during flood events, and whether flood water discharges from the pump station are allowed.
- ◆ Acceptance test-A full run acceptance test should be performed successfully before the pump station is accepted. A full run test procedure consists of running the pumps at maximum capacity for at least 6 hours and testing the control systems. During this procedure, the standby generator should be used to power the full station for at least 6 hours which will test the pumps and generator at full load. The discharge conduits can be arranged with a diverter or bypass to pour the pumped water back into the wet well to maintain the full run test.
- ◆ Scheduled Maintenance-Pump stations, unlike other hydraulic structures, require scheduled cleaning and maintenance. The trash rack should be cleaned after each storm, while the wet well sump must be cleaned whenever the sediment reaches a set point. The standby generator must be exercised at least once a month for a minimum of 30-minutes run time. The entire system including pumps should be exercised under full load at the same schedule to assure reliability. The discharge diverter or bypass from the acceptance test should be maintained so that it can be used in the scheduled maintenance monthly test.

Section 3 — Pump Station Hydrology

Methods for Design

In order to design a pump station effectively, the inflow hydrology must be known. The hydrology developed for the associated storm drain system usually will not serve as a firm basis for discharge determination into the pump station. A hydrograph is required because the time component is critical in understanding the inflow which governs the sizing of the wet well. The designer needs to know not only the peak inflow, but the timing and volume. The difference between the input and the output hydrographs is the storage requirement of the pump station wet well. The hydrograph should consider the storage abilities of the storm drain system, which may reduce the required size of the wet well. Governmental regulations or the physical limitations of the receiving waters determine the output discharge from the pump station.

The storm drain system associated with the pump station may have a design basis of less than 2% AEP. However, TxDOT recommends at least a 2% AEP flood design because the pump station is generally used when drainage by gravity from a low point is inadequate or impractical.

Procedure to Determine Mass Inflow

A mass inflow curve represents the cumulative inflow volume with respect to time. In order to determine a mass inflow curve, the hydraulic designer must first develop an inflow hydrograph based on a design storm. The most typical design method is the [NRCS Dimensionless Unit Hydrograph](#), discussed in detail in Chapter 4. For the following procedure taken from FHWA Hydraulic Engineering Circular 24 ([HEC-24](#)) example, the hydrograph data in [Table 4-31](#) of this manual will be used.

1. Evaluate the time base of the hydrograph and select a time increment, usually the same time increment as that used for developing the inflow hydrograph.
2. Develop a table with columns for time, time increment, inflow rate, average inflow rate, incremental inflow rate, cumulative inflow volume, cumulative outflow volume, and storage difference as shown in Table 11-1.
3. At each time step, extract the inflow rate from the computed inflow hydrograph. (For this example, use [Table 4-31](#), column Q_u).
4. Compute and tabulate the average inflow rate as half of the current and of the previous inflow rates for each time step. (i.e. time step 30: $188/2 \text{ cfs} + 350/2 \text{ cfs} = 269 \text{ cfs}$).
5. Compute the incremental volume for each time step as the average inflow rate multiplied by the time step in seconds.
6. Compute the cumulative inflow as the sum of each time step and the previous time step.

7. Plot a curve of cumulative volume versus time. The result is a mass inflow curve, shown as [Figure 11-1](#).
8. Determine the allowable discharge to the receiving waters. The pump flow rate must be at or below the allowable discharge rate. For this example, assume the allowable discharge rate is 100 cfs. Notice that the pumping did not start until a sufficient volume was in the wet well.
9. Multiply the allowable discharge by the time step for the pump flow. Notice that the pumping cannot start until the inflow has developed. The greatest difference between inflow and pump flow is the required storage of the facility. The greatest difference in this example is at time step 80, which is about 691,200 cubic feet. The negative numbers at time steps 230 and 240 indicate that regular pumping should have stopped at about time step 220. The Pump Flow line is also plotted with the inflow curve in [Figure 11-1](#).

Table 11-1: Mass Inflow Computation Table

1	2	3	4	5	6	7	8
Time (minutes)	Time Increment (seconds)	Inflow Rate Q_u (cfs)	Average Inflow (cfs)	Incremental Inflow (cubic feet)	Cumulative Inflow (cubic feet)	Cumulative Outflow (pump flow in cubic feet)	Storage Difference (cubic feet)
0		0	0	0	0	0	0
10	600	58	29.0	17,400	17,400	0	17,400
20	600	188	123.0	73,800	91,200	60,000	31,200
30	600	350	269.0	161,400	252,600	120,000	132,600
40	600	400	375.0	225,000	477,600	180,000	297,600
50	600	358	379.0	227,400	705,000	240,000	465,000
60	600	272	315.0	189,000	894,000	300,000	594,000
70	600	170	221.0	132,600	1,026,600	360,000	666,600
80	600	112	141.0	84,600	1,111,200	420,000	691,200
90	600	77	94.5	56,700	1,167,900	480,000	687,900
100	600	51	64.0	38,400	1,206,300	540,000	666,300
110	600	34	42.5	25,500	1,231,800	600,000	631,800
120	600	22	28.0	16,800	1,248,600	660,000	588,600
130	600	15	18.5	11,100	1,259,700	720,000	539,700
140	600	10	12.5	7,500	1,267,200	780,000	487,200
150	600	7	8.5	5,100	1,272,300	840,000	432,300
160	600	4	5.5	3,300	1,275,600	900,000	375,600

Table 11-1: Mass Inflow Computation Table

1	2	3	4	5	6	7	8
Time (minutes)	Time Increment (seconds)	Inflow Rate Q_u (cfs)	Average Inflow (cfs)	Incremental Inflow (cubic feet)	Cumulative Inflow (cubic feet)	Cumulative Outflow (pump flow in cubic feet)	Storage Difference (cubic feet)
170	600	3	3.5	2,100	1,277,700	960,000	317,700
180	600	2	2.5	1,500	1,279,200	1,020,000	259,200
190	600	1	1.5	900	1,280,100	1,080,000	200,100
200	600	0	0.5	300	1,280,400	1,140,000	140,400
210	600	0	0.0	0	1,280,400	1,200,000	80,400
220	600	0	0.0	0	1,280,400	1,260,000	20,400
230	600	0	0.0	0	1,280,400	1,320,000	-39,600
240	600	0	0.0	0	1,280,400	1,380,000	-99,600

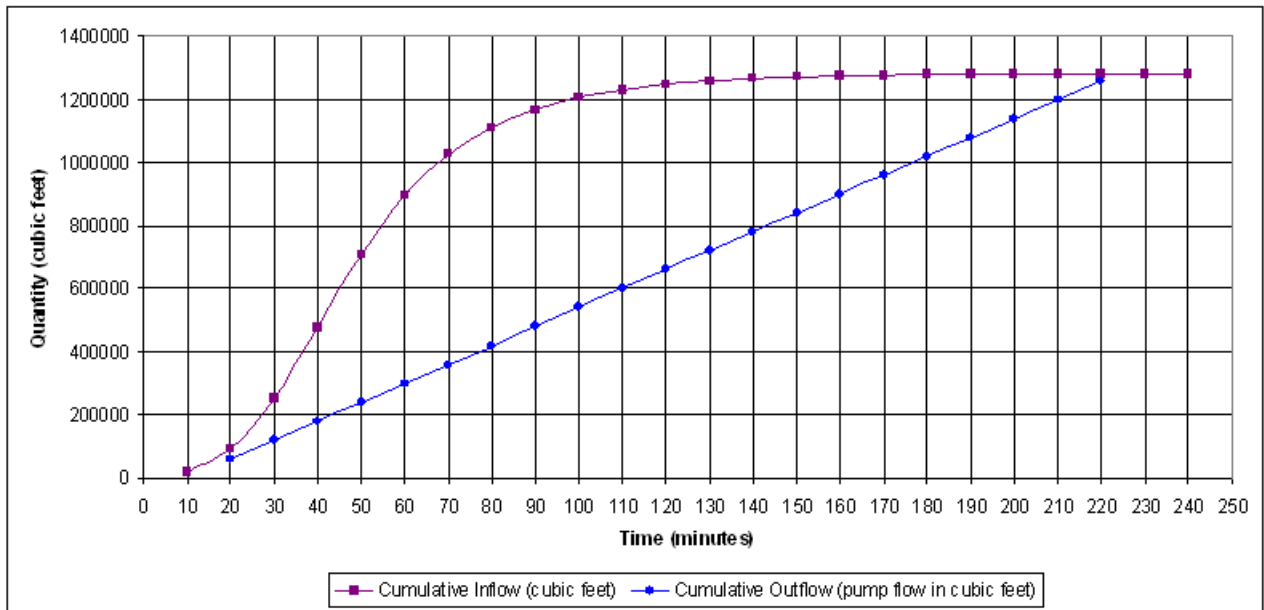

Figure 11-1. Inflow versus Pump Flow

Section 4 — Pump Station Hydraulic Design Procedure

Introduction

The hydraulic design of a pump stations has two major components, the storage design and the pump selection.

Storage Design Guidelines

The storage volume of the wet well should be less than the total volume of the wet well because allowances should be made for a sump and for freeboard. The sump is the volume of the wet well below the required minimum water level, which is the pump cutoff elevation. The wet well must maintain water above the pump inlet to keep the pump from attempting to pump dry or sucking air. The sump must also have room below the pump intake level for sedimentation and heavy trash that wash into the system.

The top of the storage volume determines the maximum water level, the level in the wet well above which the water should not be allowed to exceed. Any freeboard above the maximum water level is not included in the calculated storage volume. Pumping is initiated at or below the maximum water level, and is stopped when the water drops to the minimum water level.

Other spaces outside of the wet well which can store storm water before flooding occurs may also be considered part of the available storage volume. These include sumps, pipes, boxes, inlets, man-holes, and ditches of the storm drain system. The storm drain system can represent a significant storage capacity.

Figures 11-2 and 11-3 are a pump station location plan and cross section. The cross section shows how the storm system can provide additional storage outside of the wet well.

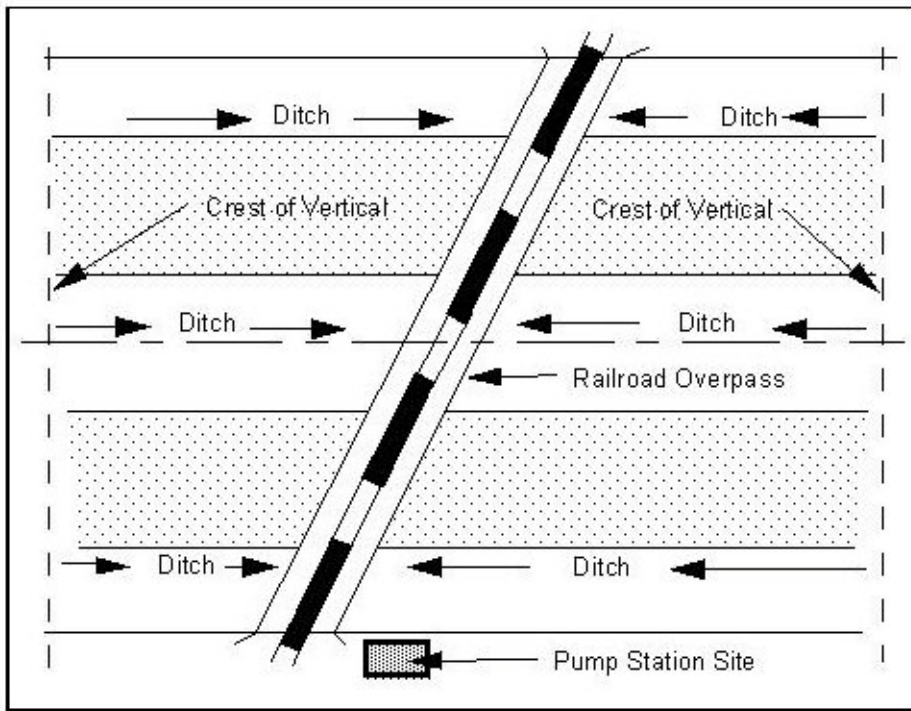

Figure 11-2. Pump Station Schematic

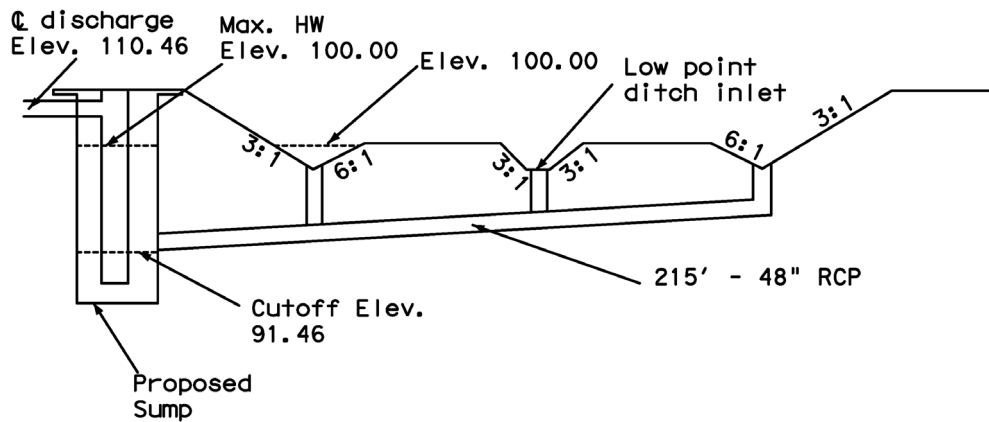

Figure 11-3. Typical Cross Section

Pump Selection

The selected rate of discharge from the pump station determines the number and size of pumps required for the facility. However, pump selection is a matter of economic analysis by the designer. To continue the example above using an allowable discharge of 100 cfs, Table 11-2 lists imaginary

pumps data. For a real design, the designer must consult manufacturer's technical data to select a pump or combination of pumps to achieve the allowable discharge.

Table 11-2: Imaginary Pump Data

Pump Designation	Pump Capacity
Type AA	5,000 gpm = 11.1 cfs
Type BB	6,000 gpm = 13.4 cfs
Type CC	7,000 gpm = 15.6 cfs
Type DD	8,000 gpm = 17.8 cfs
Type EE	9,000 gpm = 20.0 cfs
Type FF	10,000 gpm = 22.3 cfs

From Table 11-2, five Type EE pumps (20 cfs x 5) will match the allowable pump rate of 100 cfs. Alternatively, four type FF pumps (22.3 cfs x 4) will yield a pump rate of 89.2 cfs, which is less than the allowable but still a significant discharge. However, the lower pump rate will require a larger wet well volume.

The designer must also consider the cost of construction and physical restrictions for the wet well. Enlarging the wet well and using fewer pumps might be a reasonable alternative to a larger wet well. In situations where one pump may be able to supply the entire discharge necessary, a minimum of two smaller pumps is recommended for reliability and maintenance. Multiple pumps also offer the opportunity for a staggered startup of pumps. Manufacturer's printed technical data and a sales or technical representative can be invaluable sources at this stage of the design in selecting the right pumps. The final design and pump selection must be based on all the considerations together.

Chapter 12 — Reservoirs

Contents:

[Section 1 — Introduction](#)

[Section 2 — Coordination with Other Agencies](#)

[Section 3 — Reservoir Analysis Factors](#)

[Section 4 — Highways Downstream of Dams](#)

[Section 5 — Highways Upstream of Dams](#)

[Section 6 — Embankment Protection](#)

Section 1 — Introduction

This chapter deals primarily with large reservoirs, the entities responsible for the reservoirs, and their impact on highway facilities and vice versa. TxDOT storm water detention is covered in Chapter 10.

Many TxDOT highways and roadways are located either alongside of a reservoir, cross upstream of a reservoir, or cross downstream of a reservoir. Reservoirs can impact highways by affecting the following:

- ◆ the natural storm runoff
- ◆ the highway alignment and/or location
- ◆ the risk of highway overtopping
- ◆ the embankment stability

Section 2 — Coordination with Other Agencies

Reservoir Agencies

Public agencies and entities that sponsor reservoirs include the following:

- ◆ U.S. Department of Army, [Corps of Engineers](#) (USACE)
- ◆ U.S. Department of the Interior, [Bureau of Reclamation](#)
- ◆ [U.S. Department of Agriculture](#)
- ◆ [Texas Commission on Environmental Quality](#) (TCEQ)
- ◆ Various river authorities, such as LCRA, TRA, BRA, and SARA.

See [Contacts](#) for information on contacting these and other agencies. Additional sponsors include counties, cities, and political subdivisions such as utility districts and drainage districts. These agencies provide reservoirs for flood control, hydroelectric power, water supply, recreation, and land conservation.

TxDOT Coordination

Any creation of a reservoir or the improvement of a reservoir that may have an impact on a TxDOT roadway requires coordination between the reservoir sponsoring agency and TxDOT. The two regulatory agencies most involved with reservoirs are the TCEQ and the Federal Emergency Management Agency (FEMA) (See Chapter 5). Large reservoir sponsors usually present comprehensive design packages. Private ventures have sponsored reservoirs in Texas, but TxDOT generally does not deal directly with private projects because TxDOT has no process to enforce the private sector's obligation to any contract. Therefore, a reservoir project supported by private funds usually requires a contract dealing with a third party (ordinarily a public agency or entity).

The sponsoring agency is required to analyze the proposal and evaluate all impacts to the roadway, and submit the same to TxDOT for review. Mitigation of adverse impacts to the roadway resulting from construction of a reservoir is the responsibility of the reservoir agency. Adverse impacts to the highway include constant or occasional flooding and roadway damage which require relocation, revision of the highway profile, embankment protection, or adjustment of structures in order to keep the roadway in service. Where a state highway is affected, sponsors should assure the department that they are in compliance with State and Federal permits, floodplain ordinances, and environmental clearances.

Section 3 — Reservoir Analysis Factors

The primary hydraulic factors involved in the analysis of a reservoir include hydrology methods, flood storage potential, and reservoir discharge facilities. Much of the necessary analysis data can be extracted or found in the reservoir design information which should be available through the controlling agency or owner. If the design information is not available, the roadway hydraulic designer may have to develop the necessary data by analyzing the reservoir independently.

Hydrology Methods

Several different methods are available for predicting runoff rates. Some of the more productive methods are described in Chapter 4; however, more sophisticated hydrologic methods may be used. For TxDOT consideration, the peak runoff rate for the drainage area served by a reservoir should be associated with a flood event having a 2% AEP (a minimum recurrence interval of 50 years). The hydraulic designer may determine the magnitude of the 2% AEP event by procedures provided in Chapter 4, specifically the following:

[NRCS Curve Number Loss Model.](#)

[Texas Storm Hyetograph Development Procedure.](#)

[Hydrograph Routing.](#)

A comprehensive hydraulic analysis of a reservoir operation requires a valid or reliable flood hydrograph. The peak discharge alone does not suffice.

Flood Storage Potential

Often, a comprehensive reservoir design provides for sediment storage in addition to flood water storage. Provision of sediment storage helps ensure that the proposed flood water storage is available for a minimum number of years. Nearly all major reservoirs and NRCS flood water retarding structures have sediment storage provisions. In analyzing the storage proposed, only the storage provided for flood water should be considered.

The adequacy of the proposed storage should be checked by routing the hydrograph through the proposed reservoir. Consider the following:

- ◆ ordinate/time association of the flood hydrograph
- ◆ available reservoir storage
- ◆ capacity of the reservoir outlet works.

The factors of the hydrograph, storage, and outlet relations should be considered simultaneously using a routing process. Several flood routing techniques are useful for department analysis. Chapter 4 discusses [Reservoir versus Channel Routing](#).

Reservoir Discharge Facilities

For most reservoirs, the discharge capacity of the various outlet facilities influence flood routing. The administration of the discharge works is a function of the operating procedure for the reservoir. Therefore, it may be useful, in lieu of routing the flood, to secure the design notes and operating schedules from the agency responsible for operating the reservoir. Operational releases can exist for a long period of time and can even threaten the highway with sustained inundation. For this reason, the design notes and operating schedules should be carefully evaluated.

Section 4 — Highways Downstream of Dams

Peak Discharge

Urban development nearly always increases the runoff rate. Therefore, affected counties and municipalities often require that reservoirs be constructed on the primary and secondary drainage channels to minimize the effect that land development has on the storm runoff rate. This type of flood control requirement is a popular and permanent fixture in Texas.

Reservoirs upstream of a highway usually reduce the peak discharge reaching the highway for a selected frequency of storm runoff. This reduction is due to flood storage in the reservoir. Documentation for the design of large reservoirs is ordinarily complete and comprehensive; smaller reservoirs, however, often are not as well documented. Therefore, the TxDOT analysis often requires that the floods be analytically routed through the proposed storage areas to determine whether or not the required or desired reduction in the peak is accomplished.

Scour Considerations

Reservoirs can contribute to clear water scour downstream of the discharge point. Significant sediment deposition usually occurs within the reservoir whenever the reservoir tributary streams have appreciable sediment loading. As a result, water flowing out of the reservoir can be deprived of sediment, causing clear water scour to the banks and around bridge piers.

Design Adequacy

The TxDOT hydraulic designer should confirm with the reservoir agency that the reservoir has been inspected for structural adequacy and hydraulic adequacy. Unless the reservoir is consistently maintained and operated to reduce the flood peak, the reservoir should not be expected to provide consistent flood attenuation for a downstream culvert, bridge, or highway and should be ignored.

Section 5 — Highways Upstream of Dams

New Location Highways

Locating a new highway upstream of a dam and within the influence of a reservoir is usually not practicable for the department. However, if a reservoir must be crossed, the highway profile should be set high enough to reduce the risk of overtopping, and the embankment should be stabilized to prevent deterioration from water saturation and wind effects. This section provides specific criteria for setting the elevation and providing for protection of the highway embankment and structures.

Existing Highways

When a proposed reservoir is expected to impound floodwater on an existing highway location, the highway should be adjusted to meet the same conditions of structure size, embankment elevation, and protection that apply to new locations. The roadway should also be upgraded to meet current geometric design standards. All adjustments to the highway are usually the responsibility of the reservoir sponsor, as stated in the Texas Administrative Code 43 TAC 15.54(f). "Department" in this context refers specifically to TxDOT.

"(f) Highway adjustments for reservoir construction.

"(1) Where existing highways and roads provide a satisfactory traffic facility in the opinion of the department and no immediate rehabilitation or reconstruction is contemplated, it shall be the responsibility of the reservoir agency, at its expense, to replace the existing road facility disturbed by reservoir construction in accordance with the design standards of the department, based upon the road classification and traffic needs.

"(2) Where no highway or road facility is in existence but where a route has been designated for construction across a proposed reservoir area, the department will bear the cost of constructing a satisfactory facility across the proposed reservoir, on a line and grade for normal conditions of topography and stream flow, and any additional expense as may be necessary to construct the highway or road facility to line and grade to comply with the requirements of the proposed reservoir shall be borne by the reservoir agency."

Reservoirs that fall into this category are usually major facilities. The reservoir designs are usually well documented and available for the hydraulic designer's use in the analysis.

Minimum Top Establishment

The roadway embankment elevation should be measured at the point of the low shoulder (crown line), as shown in Figure 12-1.

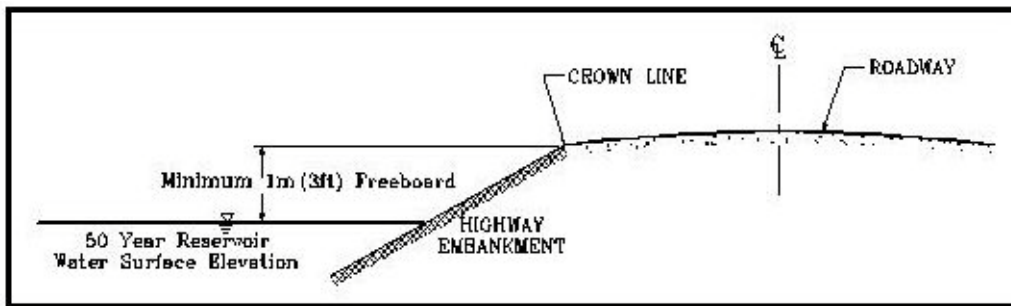

Figure 12-1. Reservoir Freeboard Requirement

The minimum top of embankment elevation should be set no lower than the elevation created by the higher of the following conditions:

- ◆ the 2% AEP reservoir surface elevation for the entire reservoir, plus a minimum freeboard of 3-feet,
- ◆ the elevation of the 2% AEP flood backwater curve as depicted in Figure 12-2, plus a minimum 3-foot freeboard to the low chord elevation of any structure,
- ◆ the elevation of the 0.2% AEP flood backwater for interstate highways and evacuation routes.

At times the crossing may be located on a tributary to the reservoir. Structures so located may at times operate independently from the reservoir, in which case the water surface elevation should be determined according to Chapter 9, Section 4, [Hydraulics of Bridge Openings](#). In cases where the crossing is located on a tributary, the minimum top of embankment should be set to the higher of the reservoir requirements above and the results of the procedure in Chapter 9.

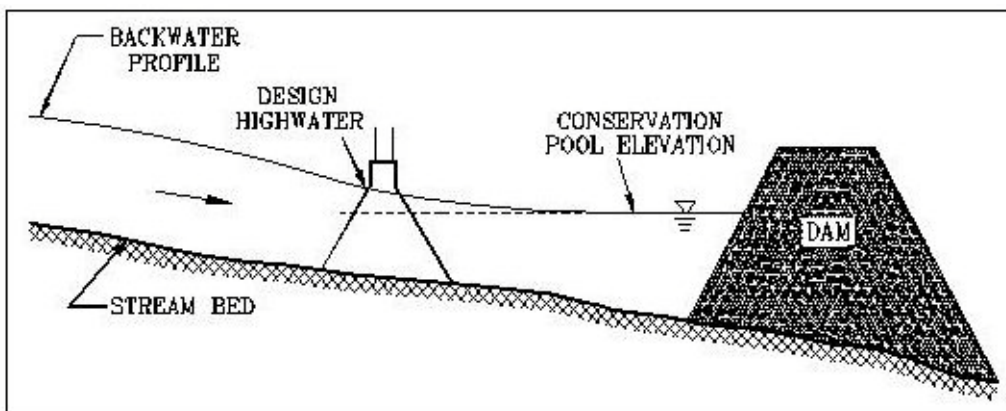

Figure 12-2.

Structure Location

Hydraulic structures located within the reservoir generally need not be situated in accordance with the stream crossing design process and guidelines outlined in Chapter 9 because the velocities are usually so low as to be insignificant. However, additional openings in the highway embankment

may be needed for flood flow conditions, and near the borders of the reservoir to ensure reservoir normal circulation.

Scour Considerations

Scour is typically not an issue for a bridge over a reservoir because the velocities are usually so low as to be insignificant. The exception to this is a structure located at the upper end of, or on a tributary of, the reservoir. This structure may at times operate independently from the reservoir, therefore experiencing higher velocities. In this case, scour depths should be calculated as if the bridge were located solely on the tributary.

Section 6 — Embankment Protection

Introduction

The best slope protection type for a given situation depends on the conditions where the installation is to be made, availability of protection material, cost of the various types, and protection desired.

The major reservoir agencies usually can help select the best protection for a given situation.

Embankment Protection Location

Embankment protection is required from the toe of the highway embankment up to an elevation equal to the conservation pool elevation, plus the effects of wind tide and wave runup.

Where the toe of the roadway embankment is below the conservation pool elevation, the minimum elevation of the top of the protection should not be less than 3-feet above the conservation pool elevation. The remaining embankment above the limits of the required protection is an area of lower risk of damage from wind effects than the area affected by wind on the conservation pool. Generally, a vegetative cover with a strong root system is adequate and very economical.

Rock Riprap

The following elements of rock riprap should be considered:

- ◆ size – Rock riprap consists of loose rock that is dumped on the slope and distributed. The size of the rock should be large enough that it withstands the forces of wind and water directed at the slope.
- ◆ placement – The rock should be placed on a bedding of sand, engineering fabric pinned to the slope, or both a bedding of sand and engineering fabric pinned to the slope. Bedding is primarily for the purpose of keeping the embankment material in place as the embankment is saturated and drained.
- ◆ keyed rock riprap – An effective rock riprap variation is keyed riprap. Keyed riprap is rock that has been placed and distributed on bedding upon the slope and then slammed with a very heavy plate to set the rock riprap in place (i.e., to key the rock together). Rock riprap is considered a rough slope when computing wave runup on the slope.

Once the wind effects are known, the weight of the median stone and the total thickness of the riprap blanket can be established using the following equations:

$$W_{50} = \frac{\gamma_s H^3}{K_D \text{Cot}(\alpha)(G - 1)^3}$$

Equation 12-1.

$$T = \eta K_{\Delta} \left(\frac{W_{50}}{\gamma_s} \right)^{\frac{1}{3}}$$

Equation 12-2.

where:

W_{50} = weight of the median sized stone (lbs.)

γ_s = specific unit weight of the stone

H = design wave height (ft.)

K_D = riprap stability coefficient, 4.37 is appropriate for TxDOT

α = slope angle from the horizontal in degrees

G = specific gravity of the stone material

W_{\max} = weight of the maximum sized stone (lbs.)

W_{\min} = weight of the minimum sized stone (lbs.)

T = thickness of the riprap layer (in.)

ζ = number of layers of W_{50} (typically taken as 2)

K_{Δ} = layer thickness coefficient (typically taken as 1)

Soil-Cement Riprap

Soil-cement riprap consists of layers of soil cement on the slope placed in prescribed lifts (Figure 12-3). This type of protection provides excellent slope protection. However, inspection and maintenance is necessary, especially at the reservoir water surface elevation that exists most of the time.

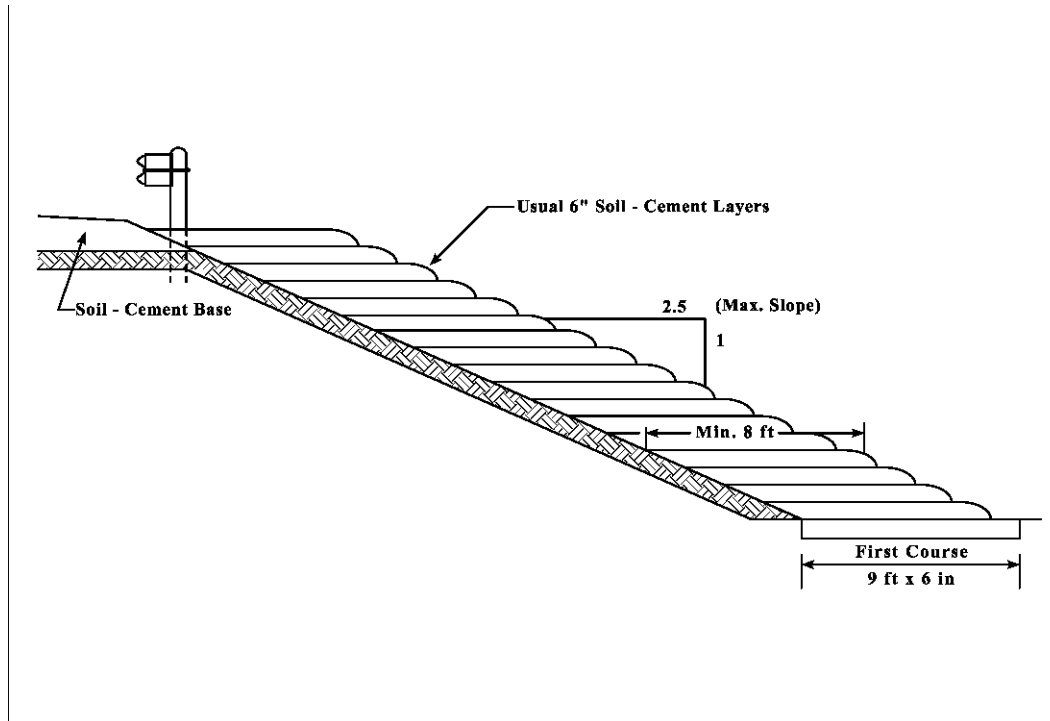

Figure 12-3. Soil Cement Riprap Specifications

Articulated Riprap

Articulated riprap is usually fabricated so that the individual elements are keyed together, and then secured by connecting cables or strands run in two directions to hold the units together. Articulated riprap is usually placed on a filter bed, engineering fabric, or both. The riprap is so named because it is flexible and can move as a unit with the slope and still remain intact. There are several commercial sources of articulated riprap. Each should be evaluated for price, performance, and experience.

Concrete Riprap

Concrete riprap usually consists of slope paving of 4 to 6-inches in thickness. Concrete riprap ordinarily is not recommended for embankment slope protection for highways within a reservoir. This is because the hydrostatic head that can exist in the embankment after it is wet cannot be relieved adequately through the concrete riprap. The riprap may bulge and fail because it does not have the structural integrity necessary to withstand the hydrostatic head of the trapped water.

Concrete riprap can be useful for short sections when placed on a bed of coarse filter material with numerous drain holes located in the riprap, and in an area where the embankment does not have standing water on the slope. There should not be constant differentials in the water surface that might cause prolonged periods of wetting and drying of the embankment.

Vegetation

The use of vegetation with large, strong root systems is a common and economical way to protect slopes. Vegetation protection can be useful on embankment slopes in a reservoir where wind effects are mild.

Chapter 13 — Storm Water Management

Contents:

[Section 1 — Introduction](#)

[Section 2 — Soil Erosion Control Considerations](#)

[Section 3 — Inspection and Maintenance of Erosion Control Measures](#)

[Section 4 — Quantity Management](#)

Section 1 — Introduction

Storm Water Management and Best Management Practices

Storm water is defined in the Construction General Permit (CGP) as "Rainfall runoff, snow melt runoff, and surface runoff and drainage." For TxDOT purposes, storm water includes overland flow, and flow in ditches and storm drain systems.

Storm water management includes non-structural and structural measures such as the following:

- ◆ erosion control to minimize erosion and sediment transport
- ◆ storm water detention and retention systems to reduce peak runoff rates and improve water quality
- ◆ sedimentation and filtration systems remove debris, suspended solids, and insoluble pollutants
- ◆ vegetation buffers to reduce transport of pollutants.

Measures intended to mitigate storm water quantity and quality problems are termed “best management practices” (BMPs). These measures include detention and retention ponds which delay storm water flow and trap sediment, rock filter dams for the same reasons, silt fences to trap sediment, various filter materials in socks or tubes, and vegetation to retard flow and trap sediment.

Quantity

Urbanization, which includes transportation activities, increases storm water volume and velocity by increasing the amount of impervious cover. Improved storm drain systems increase the rate of runoff from a location such as a roadway or land development. Recognition is growing that rapid disposal of runoff from developing areas increases the frequency of flooding in downstream areas. The results can increase flooding, soil erosion, sedimentation, stream bank erosion and channel enlargement, and pollution of surface and subsurface waters.

Where developed areas already exist are downstream of more recent development, as is the predominant sequence of development in the United States, flooding reduces property values and may lead to abandonment of property. Massive investments in flood control works are sometimes required to reduce flood damage. The alternative is to provide flood protection by storm water management in the upstream developing areas. Where pollution abatement as well as flood control is an objective, additional or alternative storm water management measures may be necessary to provide source control of storm water pollution.

Water quality problems in surface waters often stem from nonpoint as well as point sources of pollution. A point source is a single identifiable localized source of pollution while a nonpoint source comes from diffuse sources, such as polluted runoff from agricultural areas draining into a river.

Water quality goals for surface waters cannot be achieved solely by separation of combined sewers but require abatement of pollution from nonpoint sources as well.

Highway construction, operation, and maintenance contribute a variety of pollutants to surface and subsurface water. Solids, nutrients, heavy metals, oil and grease, pesticides, and bacteria all can be associated with highway runoff. Although the impacts of highway runoff pollution on receiving waters may not be significant, it is generally recognized that responsible agencies may be required by federal and state regulations to apply the BMP available to reduce pollutant loads entering a water body. One of the primary objectives of an Environmental Impact Statement (EIS) is the quantification of possible pollutants emanating from the operation and maintenance of highway and other transportation facilities, so that a sound judgment can be made as to the overall usefulness of the facility. (For more information on EIS, refer to the [Environmental Documentation](#) in the *Project Development Process Manual*.)

Requirements for Construction Activities

The TxDOT publication [Storm Water Management Guidelines for Construction Activities](#) (TxDOT, 2002) details the department's procedures and recommended BMPs to be included in a [Storm water Pollution Prevention Plan](#) (SW3P) for proposed projects. Appropriate BMPs are recommended for all construction projects.

Storm Drain Systems Requirements

The U.S. Environmental Protection Agency (EPA) National Pollution Discharge Elimination System (NPDES) permit requirements for Municipal Separate Storm Sewer Systems (MS4) are the primary regulations that may affect the extent to which storm water BMPs are necessary. The [Division of Environmental Affairs](#) should be consulted to determine the status of the permit and the management plan for the municipality of interest.

In addition to NPDES permit requirements, over the Edwards Aquifer recharge zone, TxDOT is obligated to comply with a memorandum of understanding with the TNRCC that espouses the need for BMPs. Refer to the [Division of Environmental Affairs](#) for details of the most current agreement.

Section 2 — Soil Erosion Control Considerations

Erosion Process

Understanding erosion is necessary as a basis for adequate control measures. Erosion is caused by rainfall, which displaces soil particles on inadequately protected areas, and by water running over soil, carrying some soil particles away in the process. The rate of soil particle removal is proportional to the intensity and duration of the rainfall and to the volume and characteristics of the water flow and soil properties. Deposition of water-borne sediment occurs when the velocity decreases and the transport capacity of the flowing water becomes insufficient to carry its entire sediment load.

Schematically, Figure 13-1 illustrates the typical forces involved in soil erosion.

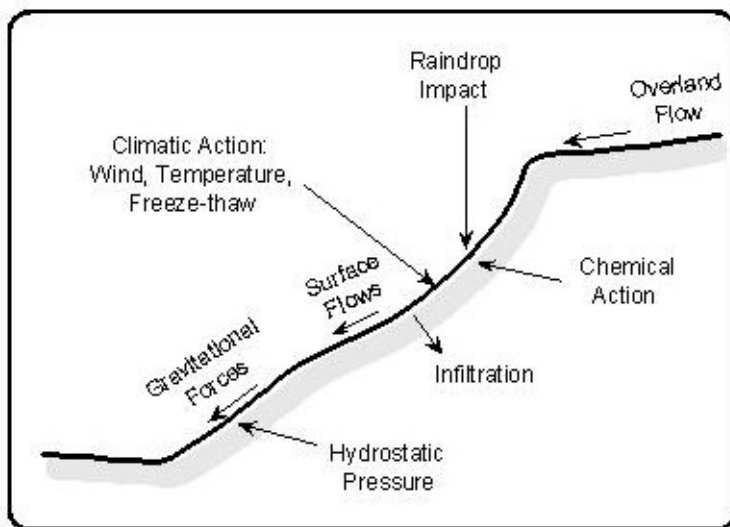

Figure 13-1. Typical Forces in Soil Erosion

It is usually not practical for the department to reduce erosion generated upstream of the highway. If possible, locations with high erosion potential should be avoided. In areas of considerable natural erosion and accelerated erosion, the quantity of sediment that reaches a stream before highway construction begins should be documented in a descriptive or qualitative way.

Damage that can occur on highway projects is not limited to the construction site. Sedimentation or degraded water quality may occur far downstream from the point where erosion occurs. The potential for damage exists because highways pass through watersheds, disrupting the natural drainage pattern. In addition, highway construction requires the removal of existing vegetation and the introduction of cuts and fills. This exposes large areas of disturbed soil, which increases the erosion hazard.

The potential for erosion is minimized by the following measures:

- ◆ flat side slopes, rounded and blended with natural terrain
- ◆ drainage channels designed with due regard to width, depth, slopes, alignment, and protective treatment
- ◆ protection at culvert outlets
- ◆ proper facilities for ground water interception
- ◆ dikes, berms, and other protective devices
- ◆ protective ground covers and plantings.

Erosion is a natural process that human activities often accelerate. Erosion and sedimentation are usually undesirable from an environmental standpoint. Technical competency in evaluating the severity of erosion problems and in planning and designing preventive and corrective measures is essential toward the goal of obtaining economical and environmentally satisfactory methods for erosion control.

Individuals involved in the process of controlling erosion and sedimentation include planners, designers, construction engineers, project inspectors, and contractors.

Effective and practical measures are available to minimize the erosion hazards and prevent sediment from reaching streams. Preventive measures taken during construction are more effective and economical than corrective measures. Erosion control involves the prevention of soil movement while sediment control deals with the interception of sediment-laden runoff and separation of soil particles already in motion or suspension. Erosion control at the source is the first consideration with sediment control the backup or last resort. Contact the DES-HYD for detailed information.

To deal adequately with the erosion and sediment problem, the erosion and sedimentation processes must be understood, erosion and sediment control plans must be developed, construction operations for erosion and sediment control must be scheduled, specific erosion and sediment control measures (when, where, and how) must be constructed, and water quality must be monitored and maintained.

The following general guidelines are considered BMPs:

- ◆ Select a route where erosion will not be a serious problem.
- ◆ Design slopes to be flatter than with soil limitations.
- ◆ Reduce the area of unprotected soil exposure.
- ◆ Reduce the duration of unprotected soil exposure.
- ◆ Protect soil with vegetative cover, mulch, or erosion resistant material.
- ◆ Retard runoff with planned engineering works.

- ◆ Trap sediment using temporary or permanent barriers, basins, or other measures.
- ◆ Maintain erosion control work, both during and after construction.
- ◆ Obtain easements for legal control, where necessary.

Natural Drainage Patterns

The natural drainage pattern, including subsurface flow, must be examined for the alternate routes considered. The drainage pattern beyond the vicinity of the proposed highway location must also be studied either to minimize and avoid damage to adjacent property or streams, or to anticipate expensive preventive or corrective measures. In consideration of design work on existing roadways, the established patterns of drainage (as contrasted to natural patterns) must be examined.

Stream Crossings

Crossings should be made as nearly as practical at a right angle to the direction of flow. Emphasis should be given to the direction of the flood flow where it is different from that of the low water. The direction, rate, and volume of flood flow at various stages in the location of bridge openings should always be considered. A highway built on the neck of a horseshoe bend that is subject to overflow is poorly located because the correct location of relief bridges sometimes varies with the flood stage.

Whenever practical, stream crossings should be at stable reaches of a stream. Meanders in the stream that are subject to shifting should be avoided. Meandering streams have inherent problems of having no stable place to cross because the sinusoidal pattern of the stream naturally tends to progress in a downstream direction.

The number of stream crossings and the disturbance of streambeds should be minimized. Crossing and then re-crossing the same stream should be avoided. Undue scour and erosion that might result in a complete change in the river channel should be avoided.

See Chapter 9, [Planning and Location Considerations](#), for more details on planning and location.

Encroachments on Streams

If a proposed highway alignment will encroach upon a stream, consider moving the highway away from the stream to avoid erosion and sedimentation problems. For an existing roadway that already encroaches on or near a stream, improvements or rehabilitation work should be planned to minimize further encroachment. If the stream impinges and encroaches on the highway, the highway itself may need to be protected.

Public and Industrial Water Supplies and Watershed Areas

If possible, crossing of a catchment area of a water supply should be avoided. Such crossings could entail building costly temporary facilities for the water supply. Some industries require higher quality water than is required for drinking water, so problems with industrial water supplies may be as great as those with a public water supply. When crossing a water supply catchment area cannot be avoided, any corrective measures and their costs should be determined before making the choice of the route.

Geology and Soils

Knowledge of the area's geology allows the highway designer to detect potential problem areas and anticipate subsidence, landslides, and erosion problems. Terrain features are the result of past geologic and climatic processes. Erosion and deposition by running water are major geologic processes in shaping the terrain. A study of the terrain and the character of natural and accelerated erosion can aid in judging the complexity of the erosion and in estimating what erosion control measures may be required.

Some soil types are known to be more erosive than others, and their identification is a valuable aid in route selection and erosion control. The U.S. Department of Agriculture classification of soils is helpful. Soil survey maps, prepared by the [Natural Resources Conservation Service](#) (NRCS), show this classification as well as the engineering classification of soils. Local NRCS offices can give much assistance in both soil identification and erosion control measures applicable to the local area.

Problems in route selection for a new roadway can sometimes be avoided. For an existing roadway, however, problems must be recognized and precautions taken in the design.

Coordination with Other Agencies

Plans or projects of other agencies, such as the [USACE](#), [NRCS](#), and [TCEQ](#), might affect or be affected by the location of a proposed highway, or by improvements or changes to an existing roadway. These agencies should be contacted to learn of their plans for controlling bank erosion, protective works, and stream grade control structures or channel modifications.

Roadway Guidelines

Independent roadway grade lines that fit the terrain with a minimum of cuts and fills reduce exposed areas subject to erosion. Alignment and grade, consistent with highway safety criteria, must be blended or fit to the natural landscape to minimize cut and fill sections and reduce erosion and costly maintenance. Slopes of the roadway cross section should consider soil stability, climatic exposure, geology, proposed landscape treatment, and maintenance procedures.

Depressed roadways and underpasses require careful consideration of drainage to avoid deposition of sediment and debris on the highway and in drainage facilities. Both ground and surface water can do the following:

- ◆ pass through the highway right-of-way
- ◆ be intercepted with minimum disturbance to streams
- ◆ be intercepted without causing serious erosion problems.

The cross section can be varied, if necessary, to minimize erosion and to facilitate safety and drainage. Generally, good landscaping and drainage design are compatible with both erosion control and safety to vehicles. Right-of-way constraints often prohibit extreme flattening of embankment slopes, but they should be an important consideration to the designer in their effect on erosion.

Severe Erosion Prevention in Earth Slopes

A concentration of storm water flowing from the area at the top of cut or fill slopes causes severe erosion of earth slopes. The concentration of storm water at the top of cuts should be avoided. These guidelines should be followed in areas of severe erosion prevention in earth slopes:

- ◆ Dike or berm construction – During project construction and immediately thereafter, construct a dike or berm at the top of the cut to prevent water from running down the slope. The dike or berm should be borrow material to avoid disturbing the natural ground, in conjunction with a grassed channel or paved ditch.
- ◆ Outlet protection – Water can be spread over the natural slope or carried to lower elevations in chutes or closed pipes. Protect outlets for such high velocity chutes from scour. Streams in cut sections require special attention.
- ◆ Serrated slopes – In some areas of Texas, serrated cut slopes help establish vegetative cover on decomposed rock or shale slopes. Serrate any material that is rippable or that will hold a vertical face for a few weeks until vegetation becomes established.
- ◆ Shoulder drains -- Where vegetation cannot be established or where flow down the fill slope is objectionable, collect the runoff at the shoulder edge and direct it to an adequate inlet and chute.

Channel and Chute Design

Surface channels, natural or man-made, are usually the most economical means of collecting and disposing of runoff in highway construction if concentration of flows cannot be avoided. A well-designed channel carries storm water without erosion or hazard to traffic and with the lowest overall cost, including maintenance. To minimize erosion and avoid a safety hazard, channels should have mild side slopes and wide rounded bottoms. Such channels can be protected from erosion by lining them with materials such as grass, rock, or concrete.

Chutes generally are applied to steep slopes and carry water at high velocities. Pipe chutes are preferable to open chutes because the water cannot jump out of the chute and erode the slope. Dissipation of energy along the chute or at the outlet is usually necessary. In highly erosive soil, watertight joints may need to be provided to prevent failure of the facility.

Variations in channel alignment should be gradual, particularly if the channel carries flow at high velocity. Whenever practical, changes in alignment should be located on the flatter gradients to prevent erosion caused by the overtopping of the channel walls and the associated erosion. Although rectangular channel sections are usually more expensive, they are preferred on bends of paved channels to give a more positive control of the flow.

If the bank and bed material will erode at the prevailing velocities, channel lining should be considered. Protective linings for channels and streams can be very expensive. A special effort should be made to develop the most cost-effective erosion protection, including maintenance, for the particular location.

Several applications are effective for both channel and bank protection, including spur dikes, permeable spur jetties, gabions and revetment mattresses, and sheet piling. For many of these protective appurtenances, no rigorous design is available, and experience or intuition is the best guides for their consideration and application. See Chapter 7, [Channel Linings](#), for more information.

Culverts and bridges generally constrict the floodway and increase velocities, thus developing higher erosion potential. In many instances, erosion and scour at these locations damage the highway embankment, the structure itself, or the downstream channel. The energy of high velocity flow should be dissipated at the outlet of culverts and chutes where necessary, or the area protected by riprap or other types of protection. Some velocity control devices and methodologies are illustrated in Chapter 8, [Velocity Protection and Control Devices](#).

Section 3 — Inspection and Maintenance of Erosion Control Measures

Inspections

Preventive maintenance built into the highway design and construction phases will decrease maintenance costs. Experts in soil conservation, agronomy, and drainage can assist in maintenance inspections and in recommending appropriate erosion control measures. Periodic inspections of drainage and erosion control measures should be conducted shortly after completion of construction so that deficiencies can be located and corrected before they develop into major problems. Deficiencies in design or in construction procedures should be discussed with the engineering staff to avoid similar deficiencies on future projects. Coordination of responsibilities for erosion control measures among design construction and maintenance sections is encouraged.

Embankments and Cut Slopes

Embankments and cut slopes are especially vulnerable to erosion. Maintenance equipment operators should be made aware that damage to ground cover at such locations can create serious erosion problems that are difficult to correct. Surveillance of these areas by maintenance personnel should be emphasized because such areas are not easily seen from the roadway.

Channels

Channels, whether active streams or open roadside ditches, are vulnerable to erosion, especially after construction. Maintenance personnel should inspect these facilities periodically and after significant storms for any erosion that will require remedial work.

Intercepting channels should be kept clean and free of brush, trees, tall weeds, and other material that decreases the capacity of the channel. When channel deterioration reduces channel capacity, overflow may occur more frequently, and erosion or deposition in the area adjacent to the channel may take place. Natural channels that are parallel to the roadway embankment may be best maintained in their natural state. This reduces the probability of embankment erosion.

High velocity flow in chutes or ditches often overtops the sides and erodes the adjacent area. Care must be taken to inspect for holes and eroded areas under paved channels to prevent collapse of rigid sections. Projections and joint offsets that cause splash and possible erosion should be removed or repaired. The channel entrance should not permit water to flow either along the side or underneath the channel.

Periodic inspection of channel changes is necessary to avoid costly repairs. Failures during construction should be carefully analyzed before performing remedial work because changes in the original construction may be indicated.

Repair to Storm Damage

Storm damage should be repaired as quickly as possible in order to avoid additional damage. Such damage may indicate that additional protection is needed. A damaged area restored only to its pre-flood condition usually will be damaged again when a flood of similar magnitude recurs.

Erosion/Scour Problem Documentation

When maintenance personnel discover excessive scour or erosion near a bridge or other major drainage structure, those responsible should be advised so that they can take proper actions to protect the structure. A system of record keeping and documentation regarding erosion/scour problems and flood events respective to highway facilities should be established and maintained.

Section 4 — Quantity Management

Impacts of Increased Runoff

For TxDOT applications, storm water quantity management mitigates the potential effects of increased runoff rates and volumes that can often accompany development, including highway construction. These effects include increased erosion and sedimentation, increased pollutant loads, and increased flood levels and velocities. By assessing the potential for increased runoff volume and, if necessary, taking measures to offset such increases, the department can minimize the potential for detrimental impact due to storm water runoff.

Storm Water Quantity Management Practices

Storm water runoff can be collected and disposed of through an integrated system of facilities. Storm drain systems collect the runoff water initially, and it is then handled by the following:

- ◆ pumping stations
- ◆ detention systems
- ◆ retention systems
- ◆ sedimentation basins
- ◆ hazard spill tanks
- ◆ bio-filtration systems
- ◆ outfall appurtenances
- ◆ outfall channels
- ◆ man-made wetlands.

The primary options for handling or mitigating increased runoff are detention, retention, outfall appurtenances, and outfall channels.

Measures for controlling urban storm runoff can be classified as structural or non-structural. Structural measures require the construction of certain facilities, such as detention basins for temporarily storing storm runoff, thus reducing and delaying runoff peaks. The hydrologic methods for analysis of detention and retention systems are detailed in Chapter 4, [Reservoir Versus Channel Routing](#). [Chapter 10](#) details storm drain system planning and design considerations, [Chapter 11](#) gives pumping stations design and operation considerations, and outfall channel design and operation considerations and procedures are detailed in Chapter 7, [Channel Analysis Methods](#).

Non-structural measures include such practices as land use management to strategically locate impervious areas so that the resulting total hydrograph peak is less severe. TxDOT rarely is

involved in non-structural measures in association with transportation projects. Table 13-1 lists some of the measures for reducing and delaying urban storm runoff recommended by the [NRCS](#).

Table 13-1: Measures for Reducing and Delaying Urban Storm Runoff

Area	Reducing runoff	Delaying runoff
Large flat roof	Cistern storage Rooftop gardens Pool storage or fountain storage Sod roof cover	Ponding on roof by constricted downspouts increasing roof roughness: ◆ Ripples roof ◆ Gravelled roof
Parking lots	Porous pavement: ◆ Gravel parking lots ◆ Porous or punctured asphalt Concrete vaults and cisterns beneath parking lots in high value areas Vegetated ponding areas around parking lots Gravel trenches	Grassy strips on parking Grassed waterways draining parking lot Ponding and detention measures for impervious area: ◆ Rippled pavement ◆ Depressions ◆ Basins Reservoir or detention basin
Residential	Cisterns for individual homes or group of homes Gravel driveways (porous) Contoured landscape Groundwater recharge: ◆ Perforated pipe ◆ Gravel (sand) ◆ Trench ◆ Porous pipe ◆ Drywells Vegetated depressions	Planting a high delaying grass (high roughness) Gravel driveways Grassy gutters or channels Increased length of travel of runoff by means of gutters, diversions, etc.
General	Gravel alleys Porous sidewalks Hed planters	Gravel alleys

Of the measures listed in Table 13-1, detention basins or ponds, either dry or wet, are the most commonly used practices for controlling storm runoff. These facilities serve to attenuate flood peaks and flood volumes. Retention basins also are used in some instances when the total runoff volume can be stored permanently.

Refer to Chapter 4 for details of hydrograph routing by the [Reservoir Versus Channel Routing](#). The extent to which storage is provided is left to engineering judgment. You should aim to balance the risk of impact with the costs of providing storm water quantity control.