

2002

FLOODPLAIN MANAGEMENT IN TEXAS

Quick Guide

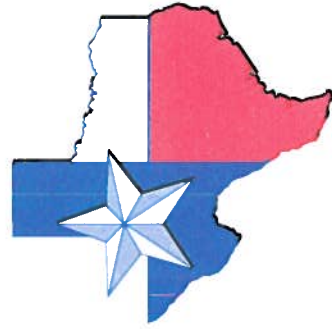

Texas Floodplain Management Association

<http://www.tfma.org>

Table of Contents

1	About This Guide	28	What is the Elevation Certificate and How is it Used?
2	Introduction	29	Completing the Elevation Certificate
3	Texas Floodplain Facts	30	Paperwork is Important – for You and Your Community
4	Flood Insurance: Property Owner’s Best Protection	31	Floodplain Fill Can Make Things Worse
5	Be Flood Safe – Don’t Drive Through Flooded Roads	32	Recommended Floodway “No Rise” Certification
6	Why Do We Regulate the Floodplain?	33	How to Elevate Your Floodplain Building (A Zone)
7	Community Responsibilities	34	Compaction of Floodplain Fill (A Zone)
8	Looking for Floodplain Information?	35	Basements are Unsafe
9	Understanding the Riverine Floodplain	36	Manufactured Homes Deserve Special Attention
10	Understanding the Floodway	37	Enclosures Below the BFE (A Zone Only)
11	New Format Flood Insurance Rate Map (Riverine)	38	Typical Elevation Methods for Coastal Buildings
12	The Flood Insurance Rate Map (Riverine)	39	Coastal Houses Must Resist Wind and Water Forces
13	The Flood Boundary and Floodway Map (Riverine)	40	The V Zone Certificate (Sample)
14	Use the Riverine Flood Profile to Determine BFEs	41	Enclosures Below V Zone Building
15	Approximate Flood Zones or Unnumbered A Zones	42	Utility Service Outside Buildings
16	Understanding the Coastal Floodplain	43	Utility Service Inside Enclosures
17	The Flood Insurance Rate Map (Coastal)	44	Accessory (Appurtenant) Structures
18	Flood Map Revisions Issued by FEMA	45	Recreational Vehicles
19	Activities Requiring Permits	46	Planning to Improve Your Floodplain Building?
20	Safe Uses of the Floodplain	47	What About After Damages?
21	Is Your Building Site Higher than the BFE?	48	Elevating a Pre-FIRM Building
22	What is Meant by Pre-FIRM and Post-FIRM?	49	Some Flood Protection for Older Homes is Easy and Low Cost
23	Nature Doesn’t Read Maps	50	Small Levees and Floodwalls Can Protect Some Older Homes
24	Think Carefully Before You Seek a Variance	51	Some Flood Mitigation Projects are More Costly
25	Some Key Permit Review Steps	52	Useful Resources and Common Acronyms
26	Carefully Complete the Permit Application	53	Want to Learn More?
27	Freeboard: Go the Extra Foot!			

About This Guide



This **Quick Guide** will help you understand more about why and how communities in the State of Texas manage floodplains to protect people and property. Flood-prone communities adopt ordinances that detail the rules and requirements. In case of conflict, that ordinance and not this publication, must be followed. If you have questions, be sure to talk with your local planning, permit, engineering or floodplain management office.

Questions and comments on the Quick Guide can be directed to the Texas Floodplain Management Association (TFMA) at <http://www.tfma.org>.

Prepared by
RCQUINN
CONSULTING, INC.
www.rcquinnconsulting.com

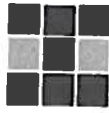
Sponsored by

Halff Associates, Inc.

Support for printing and distribution provided by

ENERGY • WATER • COMMUNITY SERVICES

bayou preservation association



TEXAS QUICK GUIDE

Introduction

The Texas Floodplain Management Association (TFMA) is pleased to provide this **Quick Guide** to help inform citizens whose properties are located within floodplains.

Communities regulate the floodplain to:

- **Protect** people and property
- **Ensure** that Federal flood insurance and disaster assistance are available
- **Save** tax dollars
- **Reduce** future flood losses

Floods have been, and continue to be, the most destructive natural disaster in terms of economic loss to the citizens of Texas. More than 12% of the state's land area is subject to flooding. Since 1978, Texas flood insurance policy holders have received over \$1.4 billion in claim payments. Even though that represents many insurance payments, most flood-prone Texans don't have flood insurance.



Texas Floodplain Facts

Presidential Disaster Declarations

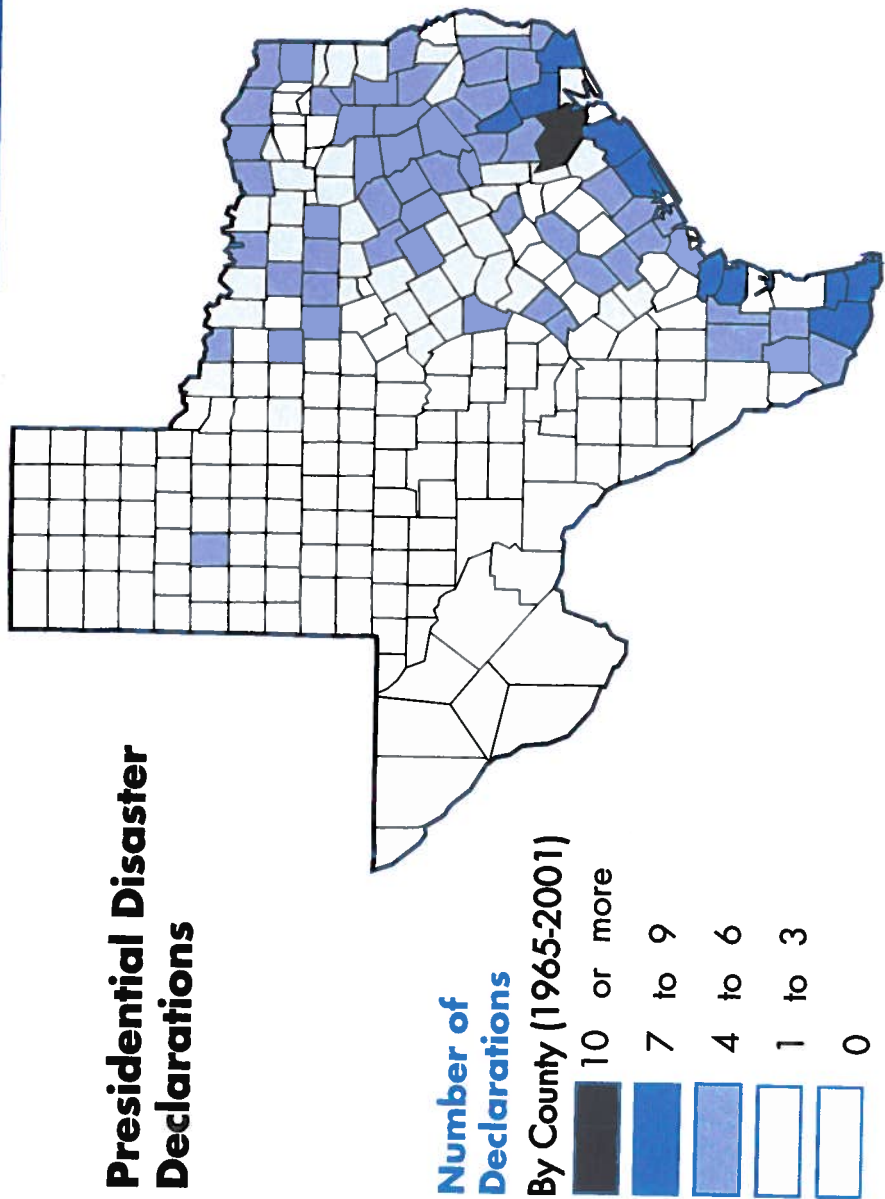

- Flood-prone areas have been identified in most counties, cities and towns in Texas.
- Millions of buildings and structures are located in mapped flood-prone areas.
- Since 1986, 376 people have died in flood-related incidents and over \$4 billion in damage has occurred.
- About 12% of the state's land area is mapped floodplain. Many waterways have not been mapped.

Not all flood events are declared major disasters. Many floods are local, affecting only small areas or a few watersheds. Not all flood events are declared major disasters.

Flood Insurance: Property Owner's Best Protection

Who needs flood insurance? **EVERYONE!** Every homeowner, business owner, and renter in Texas communities that participate in the National Flood Insurance Program may purchase a flood insurance policy — regardless of the location of the building.

Unfortunately, it's often after a flood that many people discover that their homeowner or business property insurance policies do not cover flood damages. Approximately 25% of all flood damages occur in low risk zones, commonly described as being "outside the mapped flood zone."



NATIONAL FLOOD INSURANCE PROGRAM

The Texas Floodplain Management Association and the State of Texas urge **YOU** to protect your financial future by getting a flood insurance policy. To purchase a policy, call your insurance agent. To get the name of an agent in your community, call the NFIP's toll free number 1 (888) FLOOD29.

Be Flood Safe — Don't Drive Through Flooded Roads

Flood Hazard Chart for Cars

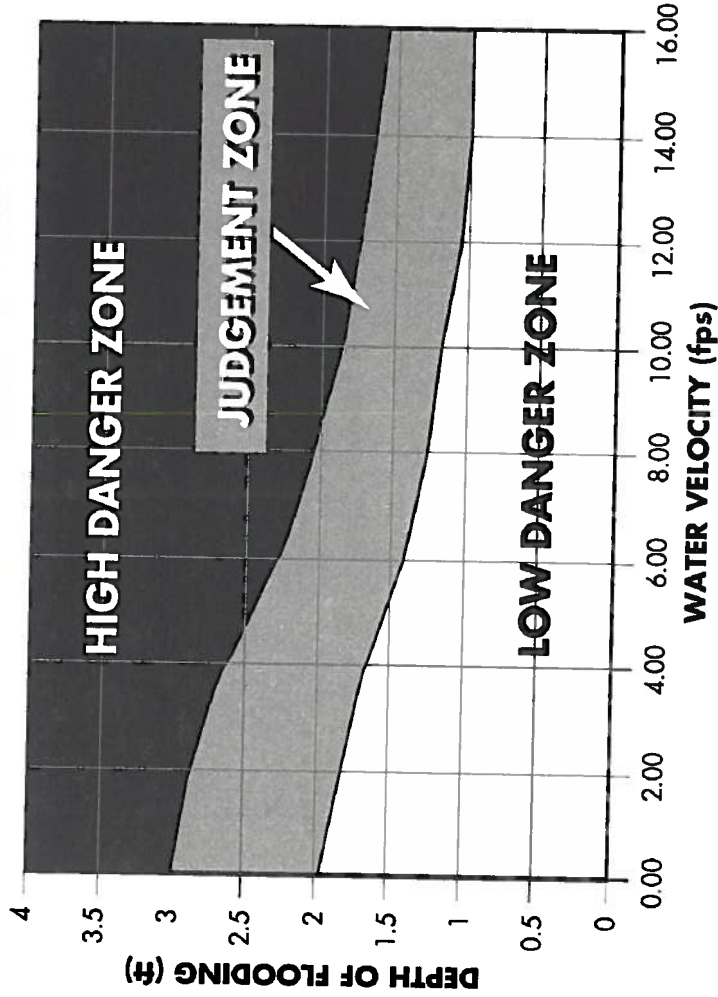

SOURCE: USBR, "Downstream Hazard Classification Guidelines," 1988

- Flooded roads may be washed out.
- Passenger cars may float in only 18-24 inches of water.
- Floating cars easily get swept downstream, making rescues difficult and dangerous.
- Hundreds of people have died in floods in Texas — many were trapped in cars.

Flash floods are dangerous!

Do not try to walk or drive through fast-moving water.

Why Do We Regulate the Floodplain?

- **To protect people and property.** Floodplain management is about building smart. It makes good sense. If we know part of our land will flood from time to time, we should make reasonable decisions to help protect our families, homes, and businesses.
- **To make sure that federal flood insurance and disaster assistance are available.** If your home or business is in the floodplain, and federal flood insurance isn't available, then you can't get some types of federal financial assistance. Home mortgages will be hard to find, and you won't be able to get some types of state and federal loans and grants.
- **To save tax dollars.** Every flood disaster affects your community's budget. If we build smarter, we'll have fewer problems the next time the river rises. Remember, federal disaster assistance isn't available for all floods. And even when the President declares a disaster, your community still has to pay a portion of the costs of evacuation, temporary housing, repair, and clean-up.
- **To avoid liability and law suits.** If we know an area is mapped as floodplain and likely to flood, if we know people could be in danger, and if we know that buildings could be damaged, it makes sense to take reasonable protective steps when we develop and build.
- **To reduce future flood losses in Texas.** State legislation was amended in 1999 to require all cities and counties to adopt ordinances or orders, as appropriate, to participate in the NFIP. In 2001, the authority was amended again to allow communities to require compliance with stricter local floodplain management requirements.

Community Responsibilities

To participate in the National Flood Insurance Program, your community agrees to:

- Adopt and enforce a flood damage prevention ordinance
- Require permits for all types of development in the floodplain (see page 19)
- Assure that building sites are reasonably safe from flooding
- Estimate flood elevations that were not determined by FEMA
- Require new or improved homes and manufactured homes to be elevated above the Base Flood Elevation (BFE)
- Require other buildings to be elevated or floodproofed
- Conduct field inspections and cite violations
- Require Elevation Certificates to document compliance (see pages 28 and 29)
- Carefully consider requests for variances
- Resolve non-compliance and violations
- Advise FEMA when updates to flood maps are needed



NATIONAL
FLOOD
INSURANCE
PROGRAM

Looking for Floodplain Information?

Enter the FEMA Flood Map Store at <http://web1.msc.fema.gov/MSC/>. Digital scans of flood maps can be downloaded or hardcopy maps can be ordered. Reach the Map Store by calling (800) 358-9616. For a charge, FEMA map information is available from the Texas Natural Resource Information System at (512) 463-8331.



- FEMA prepares Flood Insurance Studies and **Flood Insurance Rate Maps (FIRMs)** for communities in Texas.
- Most FIRMs show Special Flood Hazard Areas and floodways. Some FIRMs show floodplains delineated using approximation analyses (see page 15).
- Not all waterways have designated floodplains – but all waterways will flood, even though a floodplain study may not have been prepared.
- In coastal communities, FIRMs show Special Flood Hazard Areas, including areas subject to wave action (see page 17).

Need a fast answer? Visit your community's planning or permit office where flood maps are available for viewing by the public.

Understanding the Riverine Floodplain

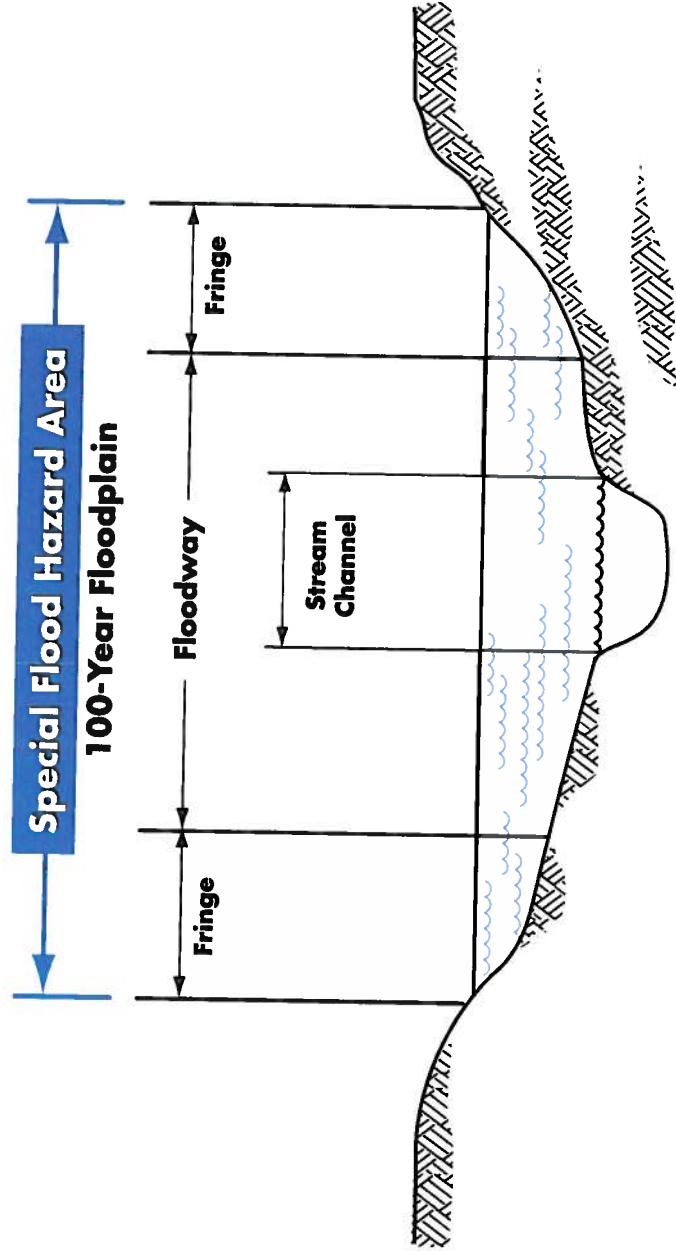

Terms and

Definitions

The **Special Flood Hazard Area (SFHA)** is that portion of the floodplain subject to inundation by the base flood and/or flood-related erosion hazards. SFHAs are shown on FHBMs or FIRMs as Zones A, AE, A1-A30, AH, AO, AR, V, VE, and V1-V30.

See page 10 to learn about the floodway, the area of the floodplain where floodwaters usually flow faster and deeper.

For floodplains with Base Flood Elevations, check the Flood Insurance Study to find the Flood Profile which shows water surface elevations for different frequency floods (see page 14).

Understanding the Floodway

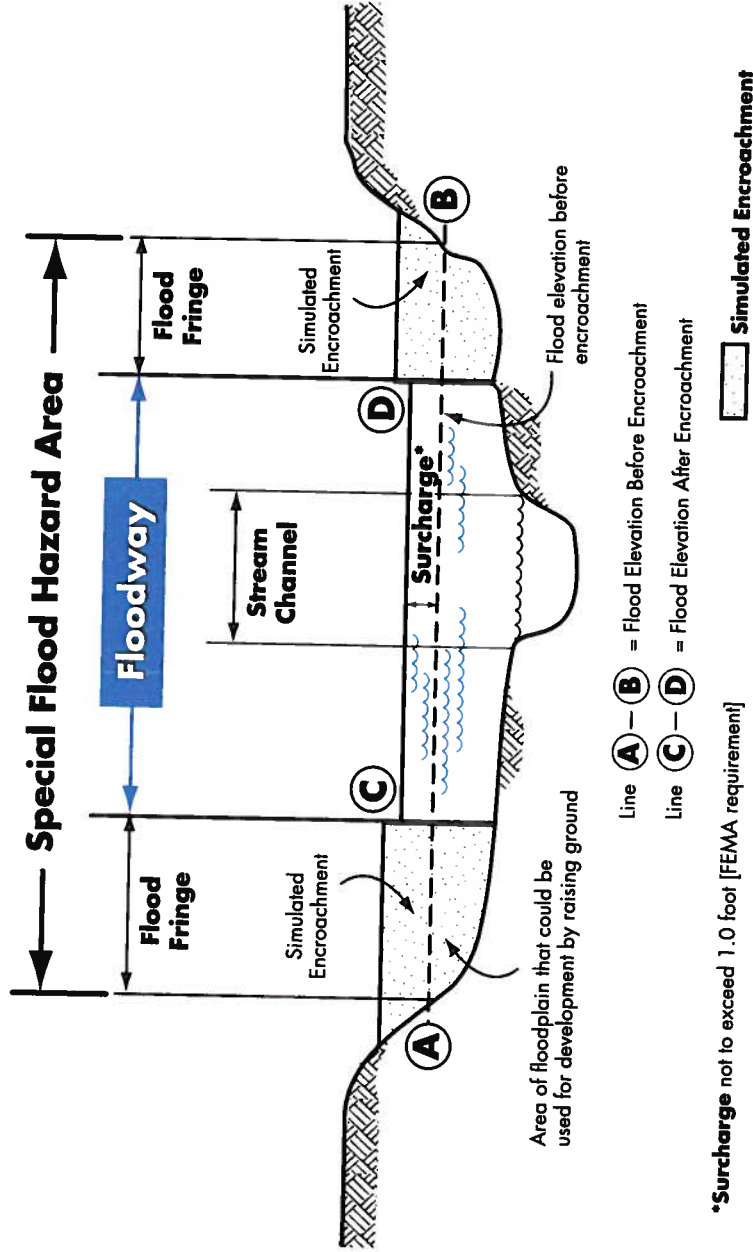

Terms and

Definitions

The **Floodway** is the channel of a river or other watercourse and the adjacent land areas that must be reserved in order to pass the base flood discharge without increasing flood depths.

Computer models of the floodplain are used to simulate "encroachment" or fill in the flood fringe in order to predict where and how much the base flood elevation would increase if the floodplain is allowed to be filled.

For any proposed floodway development, before a local floodplain permit can be issued, the applicant must provide evidence that "no rise" will occur (see page 32). You may need a qualified engineer to make sure your proposed project won't increase flooding on other properties.

New Format Flood Insurance Rate Map (Riverine)

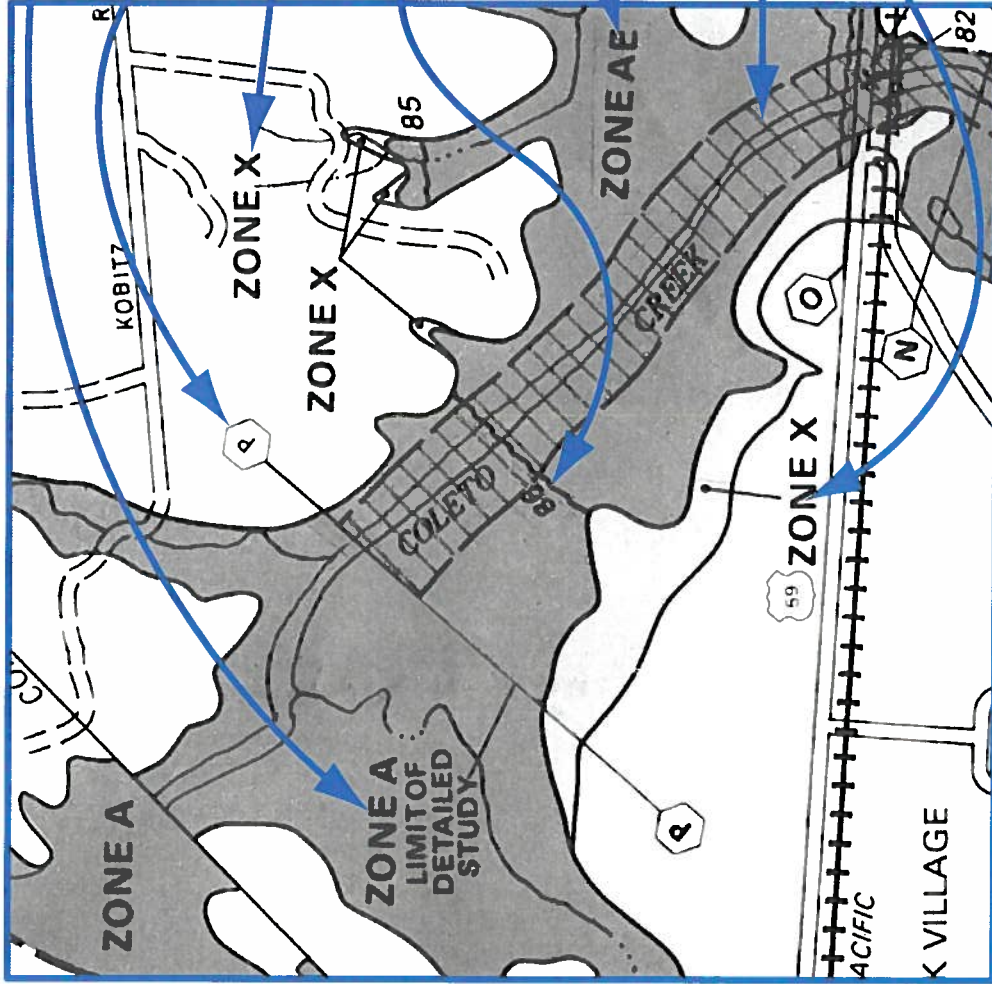

1 Zone A (unnumbered) is flood hazard areas without BFEs.

2 Cross Section location (see page 14).

3 Zone X (unshaded) is all other areas considered low risk (formerly Zone C).

4 Base Flood Elevation (BFE).

Water surface elevation of the base flood at specific locations.

5 Zone AE is the 100-year (1% annual chance) floodplain (also called Zone A, A1-A30).

6 The Floodway is the "cross-hatched" area.

7 Zone X (shaded) shows low risk areas affected by the 500-year flood (0.2% annual chance) floodplain (also called Zone B).

The Flood Insurance Rate Map (Riverine)

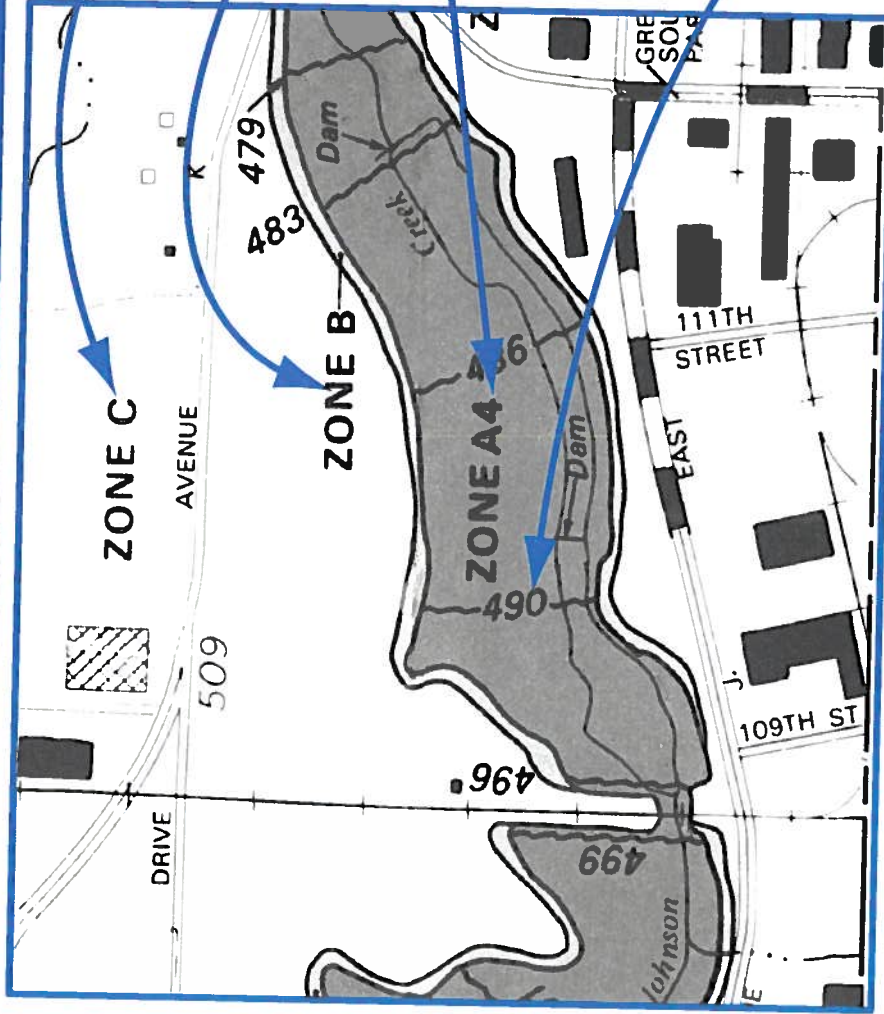

FLOOD HAZARD ZONES

1 Zone C (or Zone X) is all other areas, considered to be low-risk.

2 Zone B (or shaded Zone X) is subject to flooding by the 500-year flood (0.2% annual chance), and is a moderate risk area.

3 Zone A, Zones A1-A30 and Zone AE are subject to flooding by the base or 100-year flood (1% annual chance), and are considered high-risk areas.

4 Base Flood Elevation (BFE). Water surface elevation of the base flood at specific locations.

FEMA prepares Flood Insurance Rate Maps (FIRMs) to show areas that are at high risk of flooding after intense or major storms. Many FIRMs show the flood elevation (how high the water may rise), called the Base Flood Elevation.

The Flood Boundary and Floodway Map (Riverine)

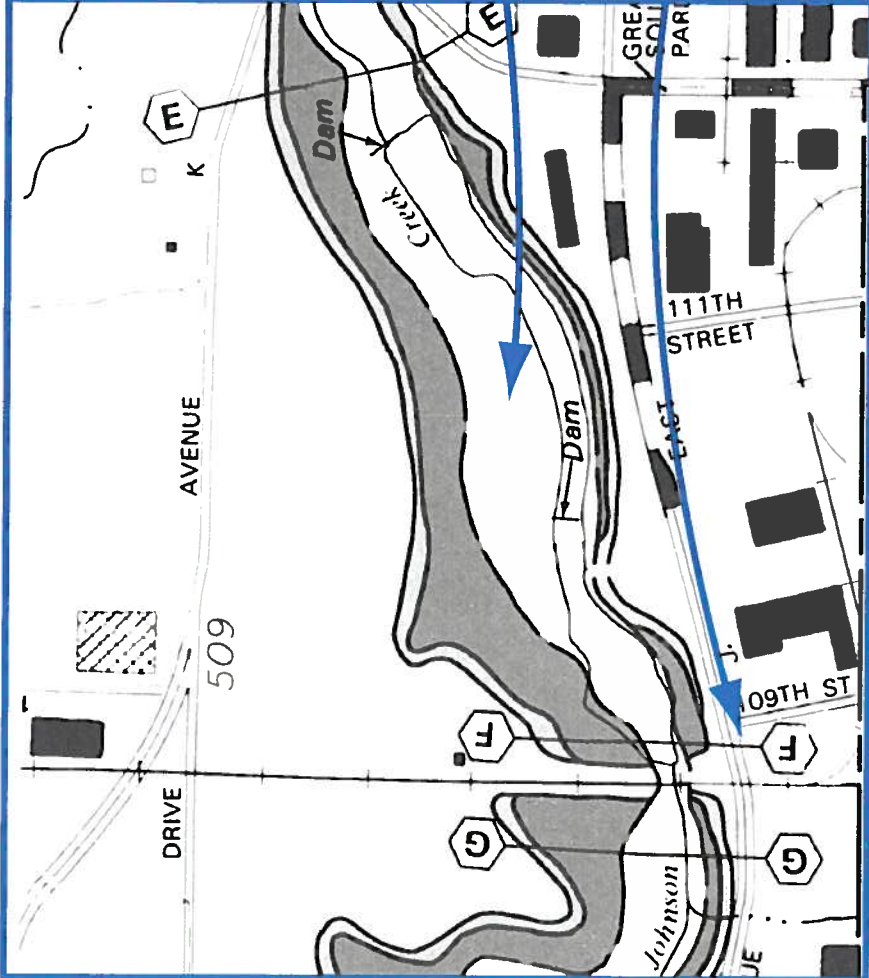

Important Information

Floodway maps do not show flood zones or BFEs. Check the companion FIRM for that information. Page 12 shows the FIRM that matches the map clip to the left.

1 The Floodway is the “white” area along the waterway.

2 Cross Section location, where ground surveys determined the shape of the land and how constrictions such as bridges and culverts affect the flow of floodwater.

FEMA prepares Floodway maps as companions to many FIRMs. You should check to see if your project will be in the Floodway because additional engineering may be required (see page 32).

Use the Riverine Flood Profile to Determine BFEs

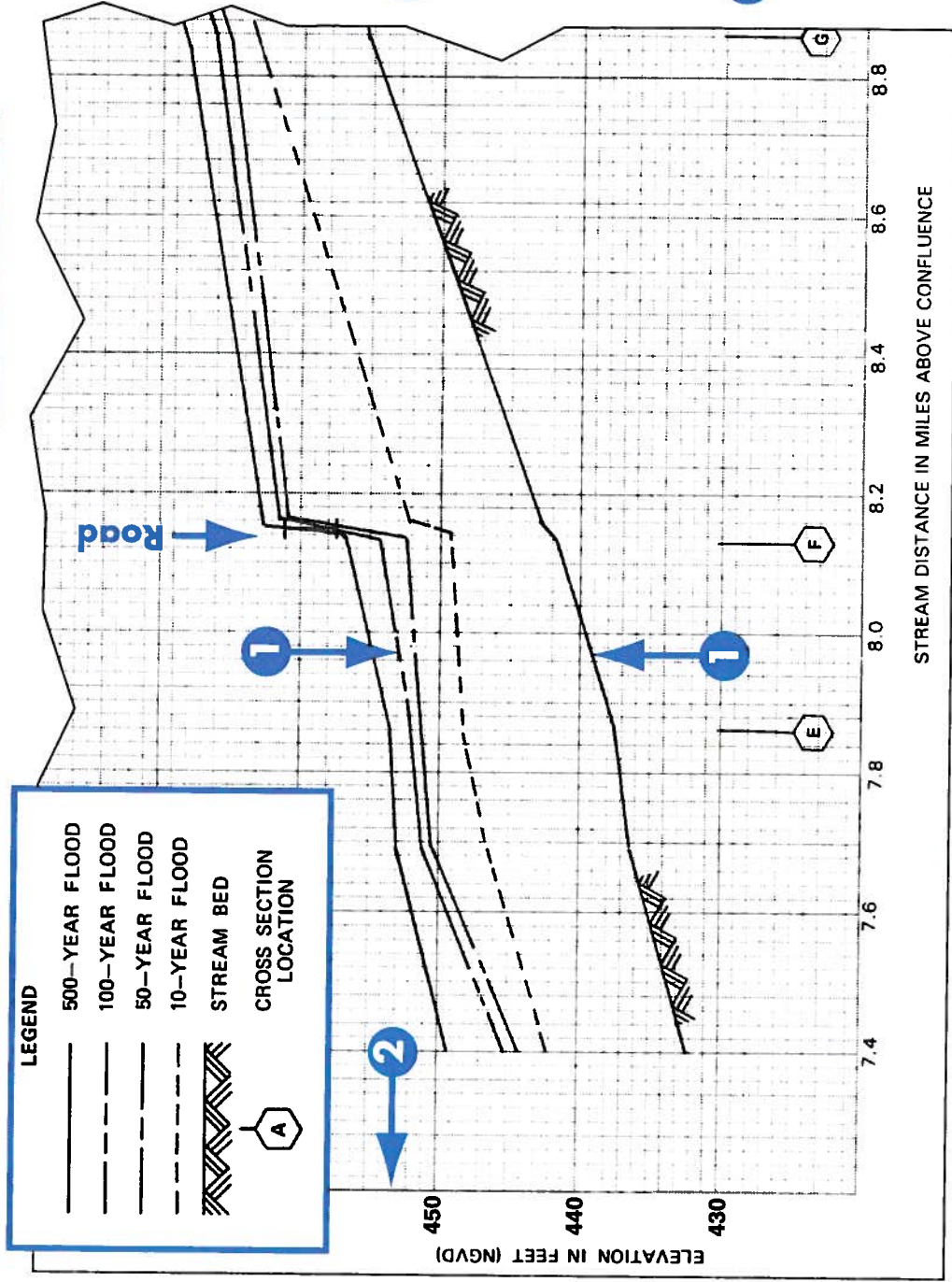

Flood profiles can be used to determine the BFE at a specific site. Profiles also show estimated water surface elevations for floods other than the 100-year flood.

1 On the effective flood map, locate your site by measuring the distance, along the center line of the stream channel, from a road or cross section, for example, **E** or **F**.

2 Scale that distance on the Flood Profile and read up to the profile of interest, then across to determine the elevation.

Approximate Flood Zones and Unnumbered A Zones

Topographic maps can be used to estimate the Base Flood Elevation if the FIRM shows approximate or unnumbered A Zones.

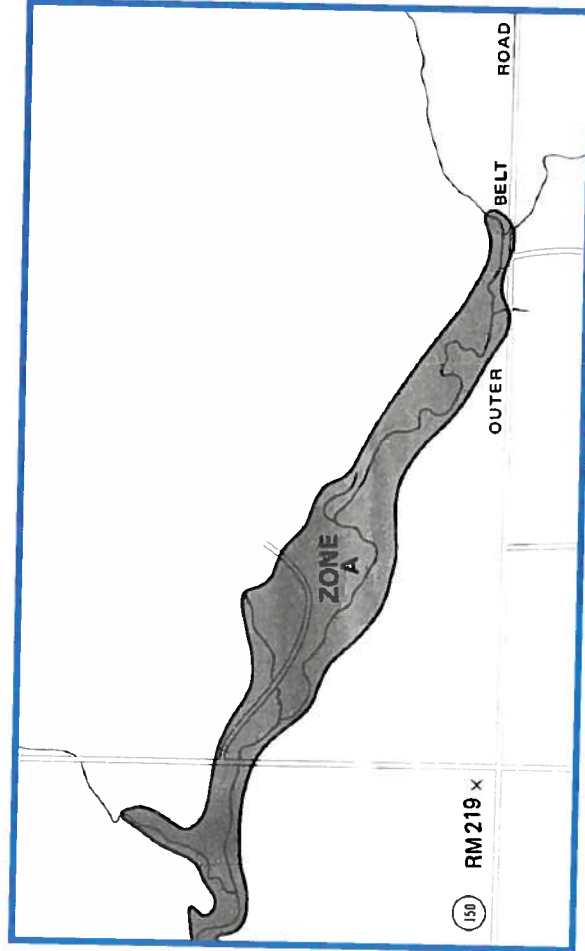
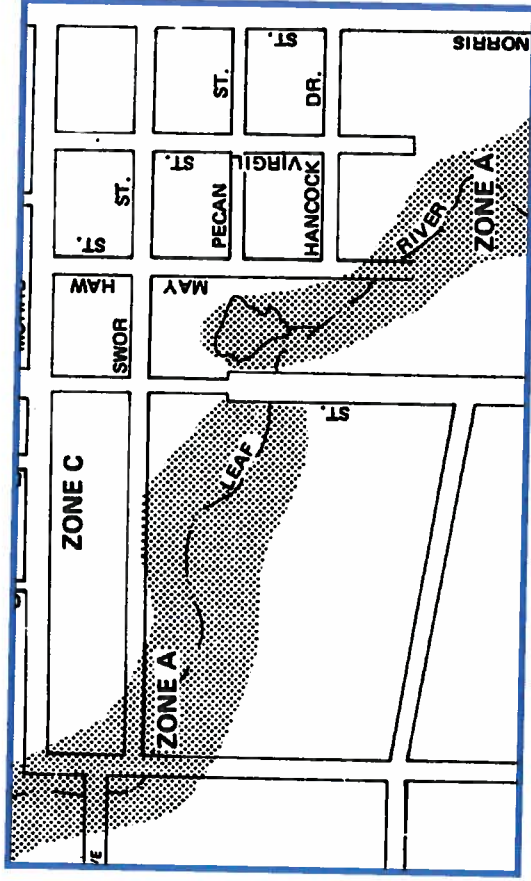

If you need help determining the BFE, check with your community permit office.

FEMA publication *Managing Floodplain Development in Approximate Zone A Areas* (FEMA 265) is useful for engineers.

Understanding the Coastal Floodplain

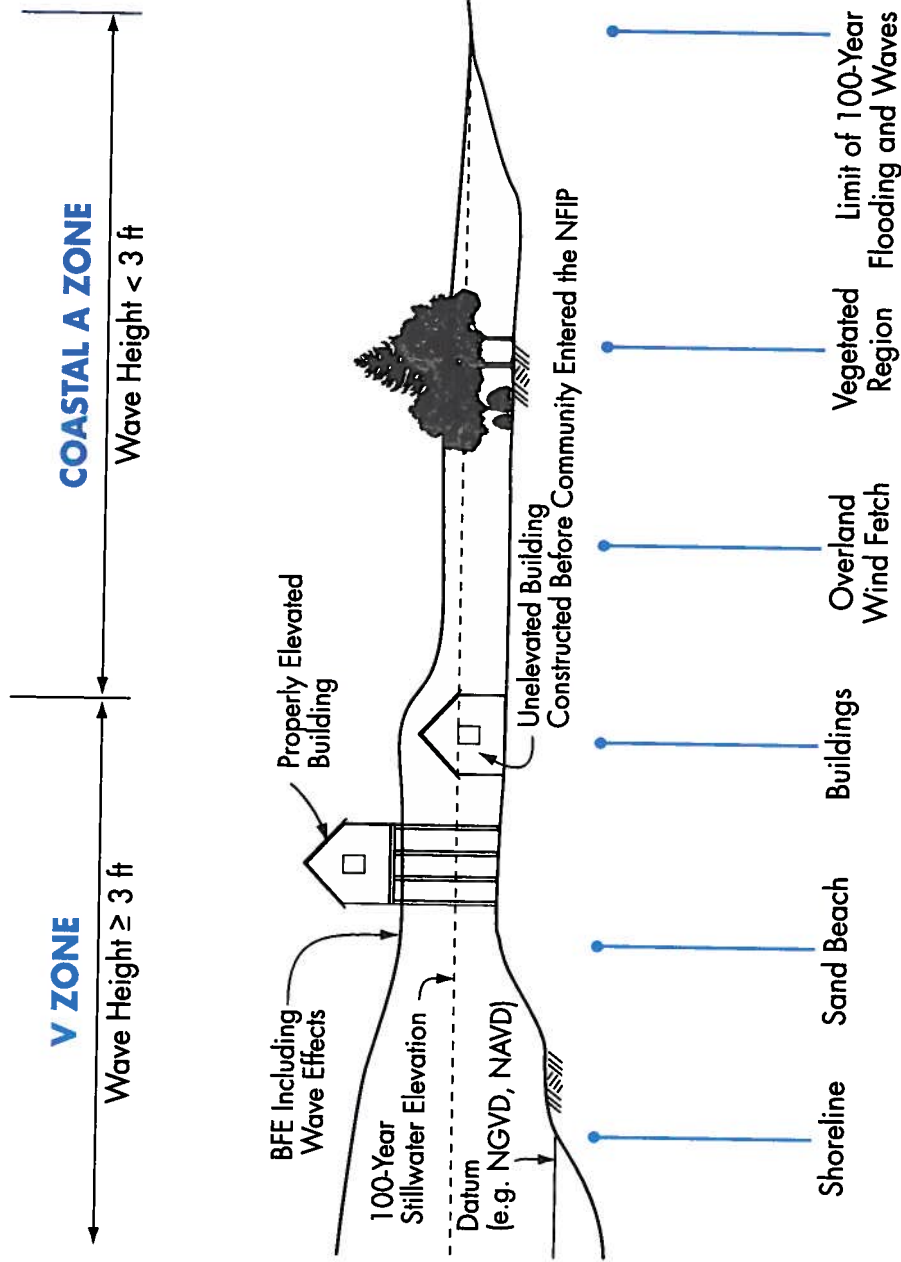

Terms and Definitions

The **Coastal High Hazard Area (V Zone)** is the area of special flood hazard that extends from offshore to the inland limit of a primary frontal dune along an open coast and any other area subject to high velocity wave action. The area is designated on the FIRM as Zone V1-V30, VE, or V.

The term **Coastal A Zone** means the portion of the SFHA landward of the V Zone or landward of a shoreline that does not have a mapped V Zone. The principle sources of flooding are associated with astronomical tides, storm surges, seiches or tsunamis. Coastal A Zones may be subject to wave effects, velocity flows, erosion, scour, or combinations of these forces and may be treated as V Zones.

Coastal graphics from Coastal Construction Manual (FEMA 55CD).

The Flood Insurance Rate Map (Coastal)

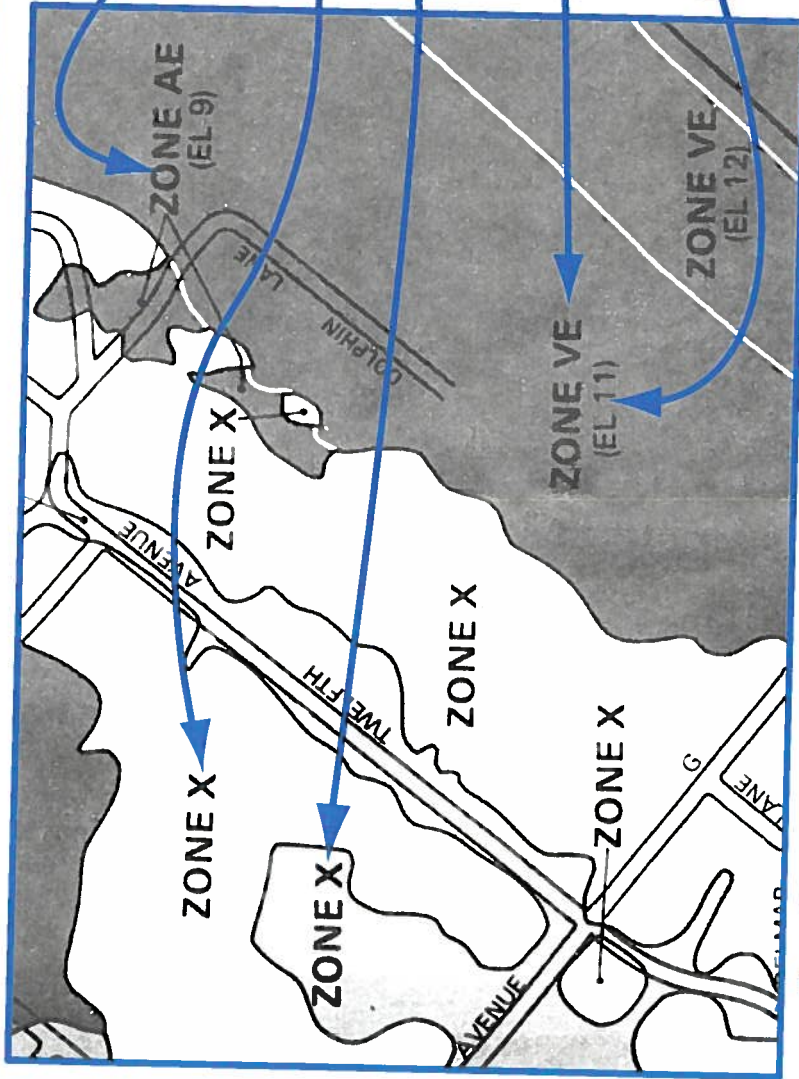

COASTAL FLOOD HAZARD ZONES.

- 1 **Zone A, Zones A1-A30, and Zone AE** are subject to flooding by the base or 100-year flood (1% annual chance), and waves less than 3 feet.
- 2 **Zone X** is all other areas.
- 3 **Shaded Zone X** (or Zone B) is subject to flooding by the 500-year flood (0.2% annual chance).
- 4 **Zone V, Zones V1-V30, and Zone VE** are where waves are expected to be 3 feet or more.
- 5 **Base Flood Elevation (BFE).** Water surface elevation (in feet above datum).

In undeveloped Coastal Barrier Resource Areas (COBRA), NFIP insurance is not available for new or substantially improved structures built after November 16, 1990.

Flood Map Revisions Issued by FEMA

- 1. Letter of Map Amendment (LOMA)** is an official amendment to an effective FIRM that may be issued when a property owner provides additional technical information, such as ground elevation relative to the BFE, SFHA, and the building. Lenders may waive the flood insurance requirement if the LOMA documents that a building is on ground above mapped floodplain.
- 2. Letter of Map Revision (LOMR)** is an official revision to an effective FIRM that may be issued to change flood insurance risk zones, floodplain and floodway boundary delineations, BFEs and/or other map features. Lenders may waive the insurance requirement if the approved map revision shows buildings to be outside of the SFHA.
- 3. Letter of Map Revision Based on Fill (LOMR-F)** is an official revision to an effective FIRM that is issued to document FEMA's determination that a structure or parcel of land has been elevated by fill above the BFE, and therefore is no longer in the SFHA. Lenders may waive the insurance requirement if the LOMR-F shows that a building on fill is above the BFE.
- 4. Physical Map Revision (LOMR PMR)** may be issued for major floodplain changes that require engineering analyses, such as bridges, culverts, channel changes, flood control measures, and large fills that change the BFE or Floodway. Physical map revisions are also issued when a new study updates or improves the FIRM.



Important

Information

Check FEMA's Flood Hazard Mapping Web Site for more information about map revisions concerning Homeowners



and Engineers/
Surveyors.



www.fema.gov/mit/tsd

Requests for map revisions must be coordinated through your community

Activities Requiring Permits Include:

- Constructing new buildings
- Additions to existing buildings
- Substantially improving existing buildings
- Placing manufactured (mobile) homes
- Subdivision of land
- Temporary buildings and accessory structures.
- Agricultural buildings
- Parking or storage of recreational vehicles
- Storing materials, including gas/liquid tanks
- Roads, bridges, and culverts
- Fill, grading, excavation, mining, and dredging
- Altering stream channels



YOU NEED PERMITS FOR ALL OF THESE ACTIVITIES.

Safe Uses of the Floodplain

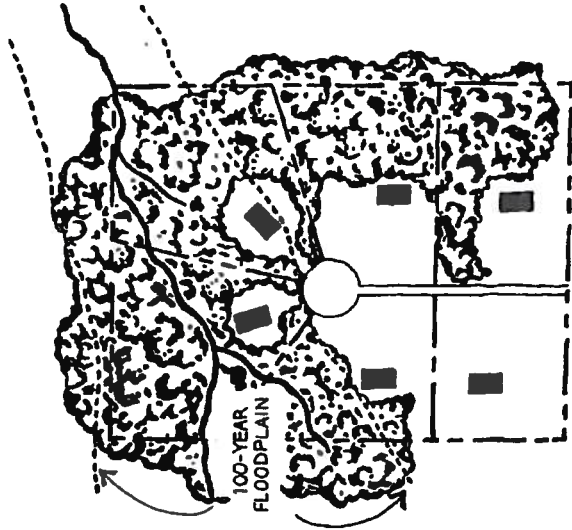

All land subdivided into lots, some homesites and lots partially or entirely in the floodplain.

NOT RECOMMENDED

All land subdivided into lots, some lots partially in the floodplain, setbacks modified to keep homesites on high ground.

RECOMMENDED

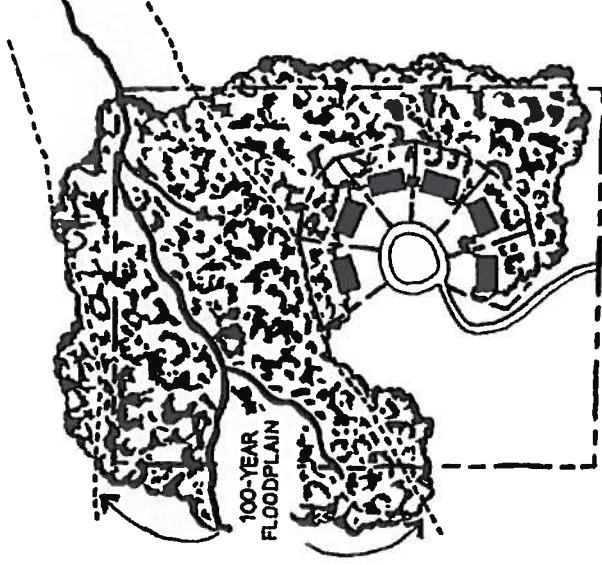
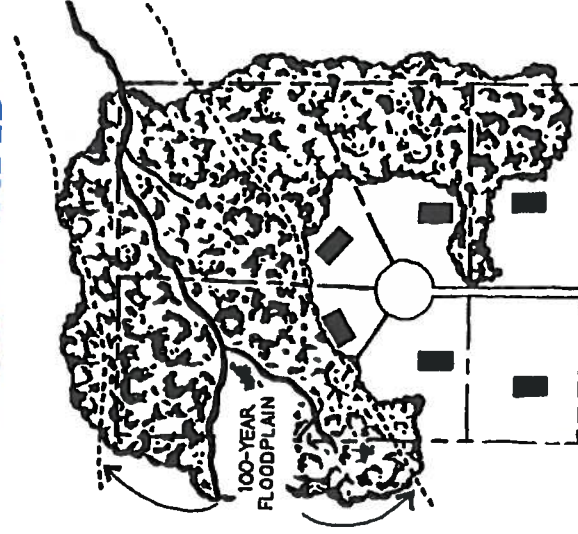

Floodplain land put into public/common open space, net density remains, lot sizes reduced and setbacks modified to keep homesites on high ground.

RECOMMENDED

Let the floodplain do its job – if possible, keep it natural open space. Other low damage uses: recreational areas, playgrounds, reforestation, parking, gardens, pasture, accessory structures, created wetlands.

Is Your Building Site Higher than the BFE?

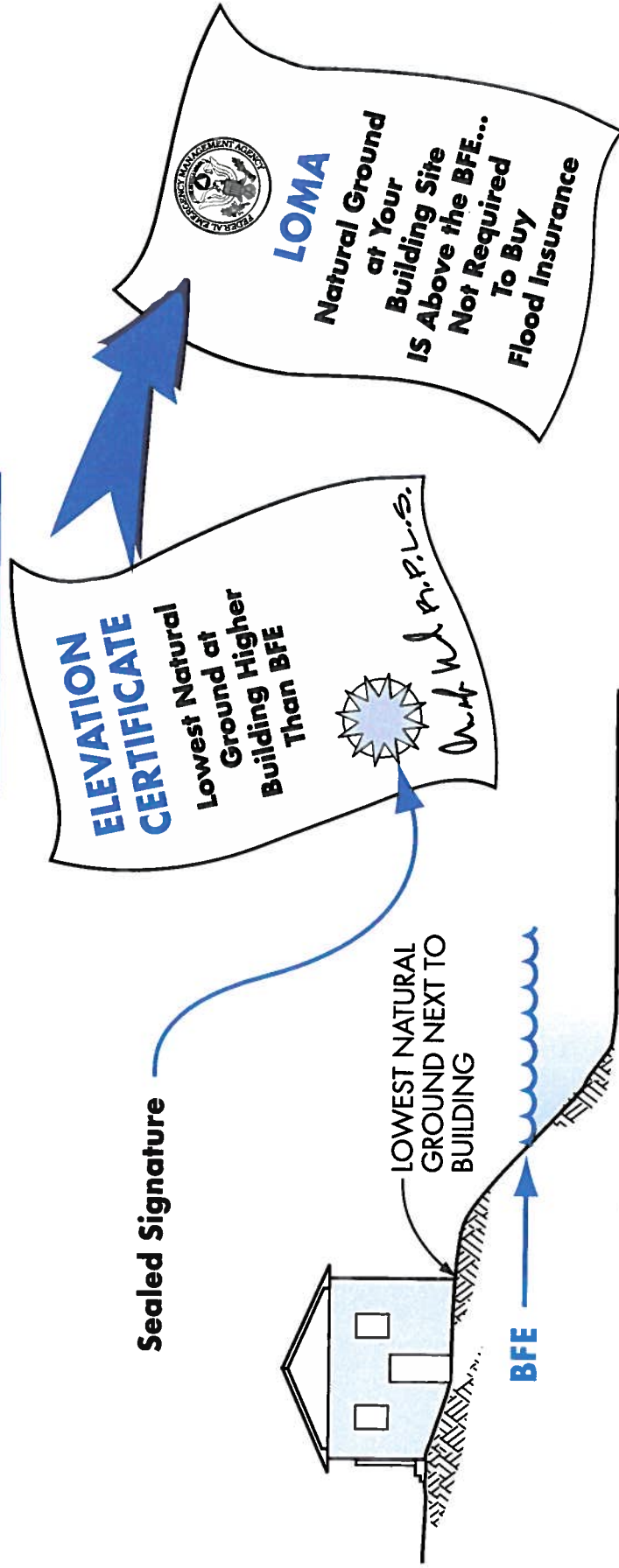

If your land is shown on the map as “in” the floodplain, but your building site is higher than the Base Flood Elevation (BFE)... get a surveyor or engineer to complete a FEMA Elevation Certificate (EC). Submit the EC with an application to FEMA and a Letter of Map Amendment may be issued (page 18).

This is the **ONLY** way to remove the requirement to buy flood insurance.
Keep the certificate with your deed, it will help future buyers.

What is Meant by Pre-FIRM and Post-FIRM?

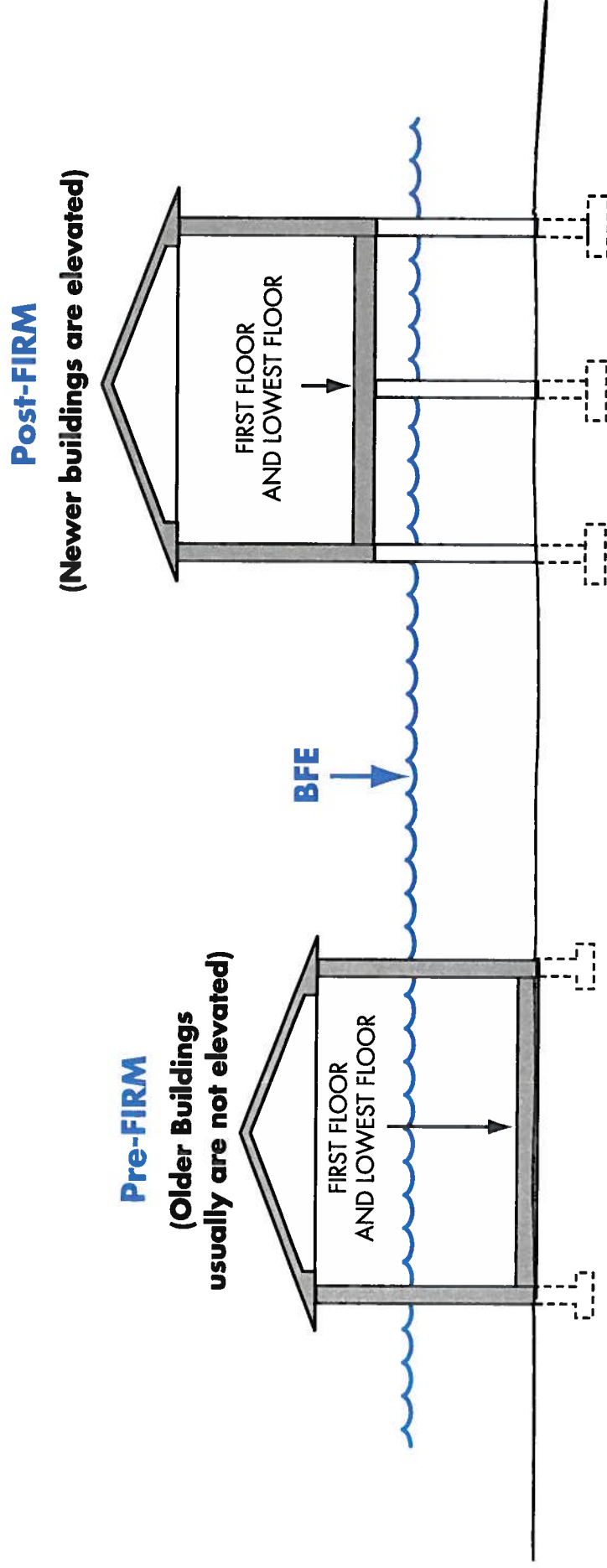

A building is **Pre-FIRM** if it was built **before** the date of your community's first FIRM.
If built **after** that date, a building is **Post-FIRM**.

Improvements or repairs to Pre-FIRM buildings may require permits (see pages 46 and 47).

Nature Doesn't Read Maps

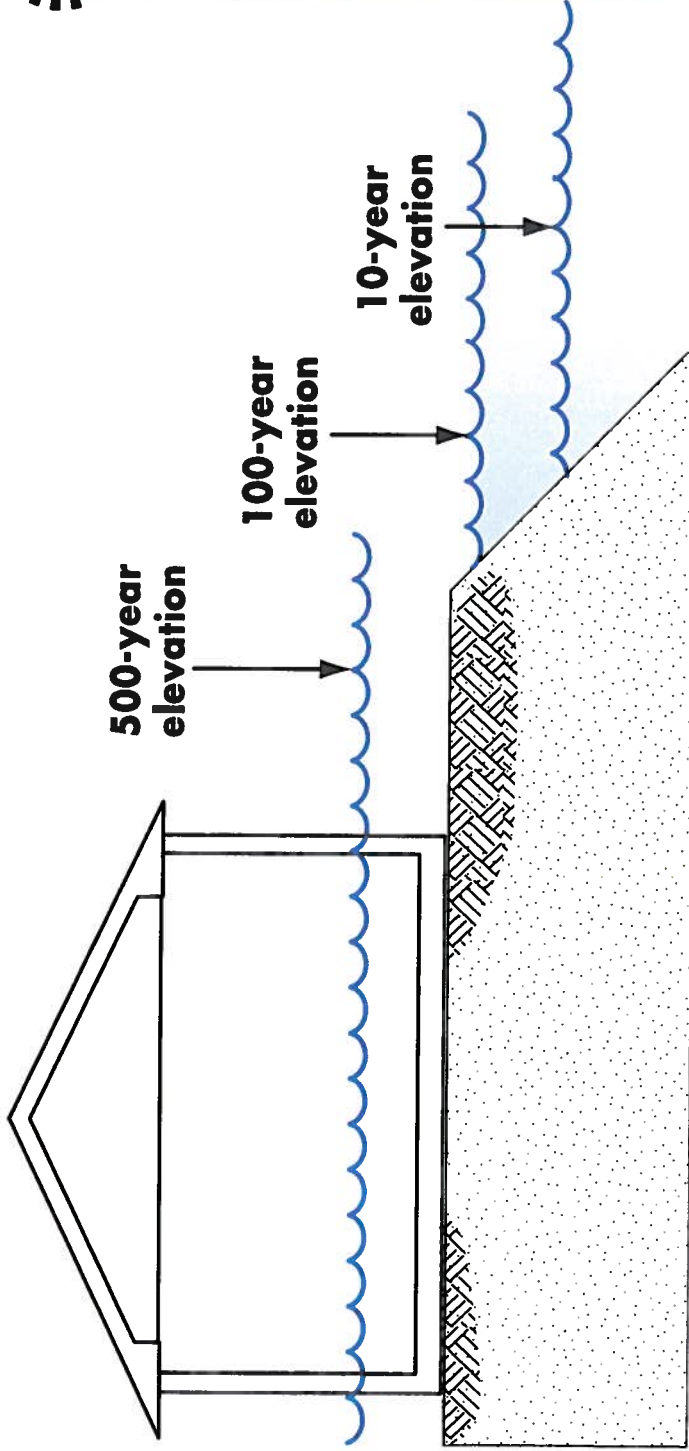

Important Information

Many people don't understand just how risky the floodplain can be. There is a 26% chance that a non-elevated home in the floodplain will be damaged during a 30-year mortgage period. The chance that a major fire will occur during the same period is only 1%!

CAUTION! Nature doesn't read the flood map! Major storms and flash floods can cause flooding that rises higher than the 100-year elevation (BFE). Consider safety – protect your home or business by building higher. See page 27 to see how this will save you money on insurance.

Think Carefully Before You Seek A Variance

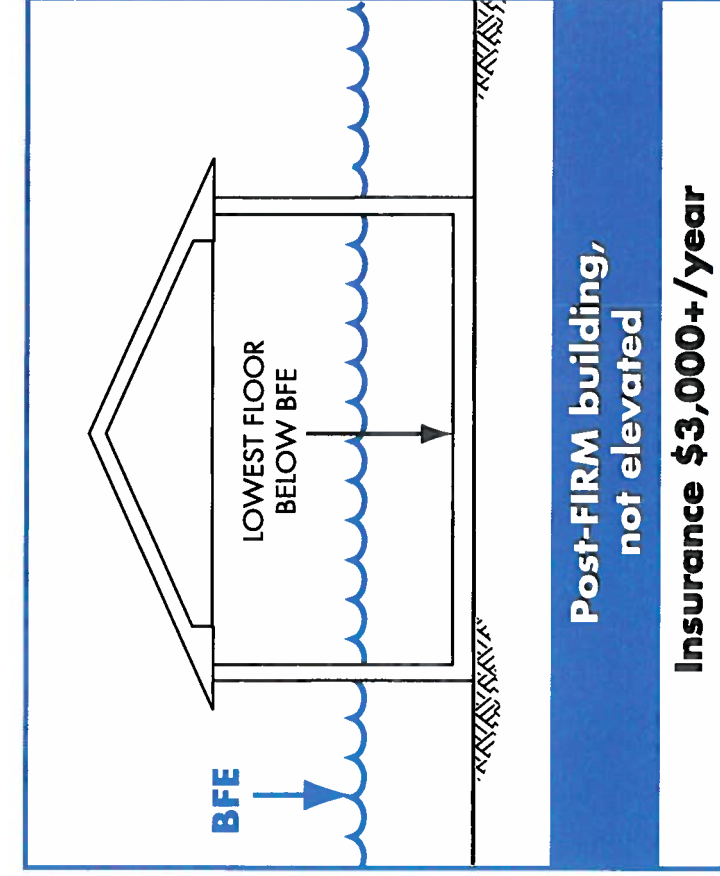

Very specific conditions must be satisfied to justify a variance:

- Good and sufficient cause
- Unique site conditions
- Individual non-economic hardship
- If in the floodway, no increase in flood level

A variance that allows construction below the BFE does not waive your lender's flood insurance requirement. Flood insurance will be very expensive – perhaps more than \$3,000 per year (see page 27)!

Think carefully about seeking a variance to build below the Base Flood Elevation.

Not only will your property be more likely to get damaged, but insurance will be very costly.

If your community has a pattern of inconsistent variances, sanctions can be imposed – costing you even more!

Some Key Permit Review Steps

The Permit Reviewer has to Check Many Things. Some of the Key Questions are:

- Is the site in the mapped floodplain?
- Is the site in the mapped floodway?
- Have other state and federal permits been obtained?
- Is the site reasonably safe from flooding?
- Does the site plan show the Base Flood Elevation?
- Is substantial improvement of an older building proposed?
- Is an addition proposed?
- Will new buildings and utilities be elevated properly?
- Will manufactured homes be properly elevated and anchored?
- Do the plans show an appropriate and safe foundation?
- Has the owner submitted an Elevation Certificate?



Carefully Complete the Permit Application



Important

Information

You must get a permit **before** you do work in a floodplain

FLOODPLAIN DEVELOPMENT PERMIT (partial)

OWNER DAVID & SALLY JONES
 ADDRESS 701 REED STREET

PROJECT DESCRIPTION

- Single Family Residential
 Multi-Family Residential
 Manufactured (Mobile) Home
 Non-Residential
 Other/Explanation _____
- New Construction
 Substantial Improvement (>50%)
 Improvement (<50%)
 Rehabilitation
- Channelization
 Fill
 Bridge/Culvert
 Levee

FLOOD HAZARD DATA

Watercourse Name DRY RIVER Floodway Floodway Fringe
 The project is proposed in the _____ Floodway 59.2
 Base (100-year) flood elevation(s) at project site _____
 Elevation required for Lowest Floor 60.2 /Floodproofing _____

Rebecca Reviewer _____ Date 4/2/2002

Floodplain Administrator's Signature _____

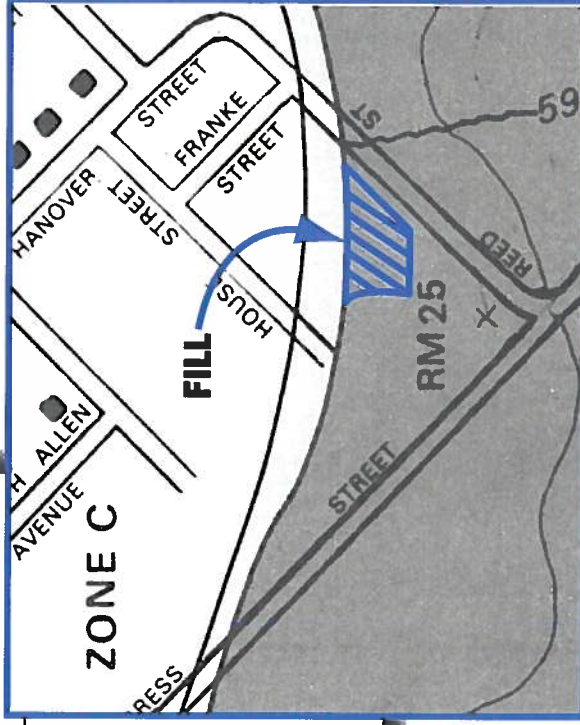

Good information will lead to better construction and less exposure to future flood damage.

Freeboard: Go the Extra Foot!

Want to save some money and have peace of mind at the same time? Then add Freeboard to build higher than the minimum elevation requirement! Freeboard is a factor of safety, usually one or two feet above the BFE.

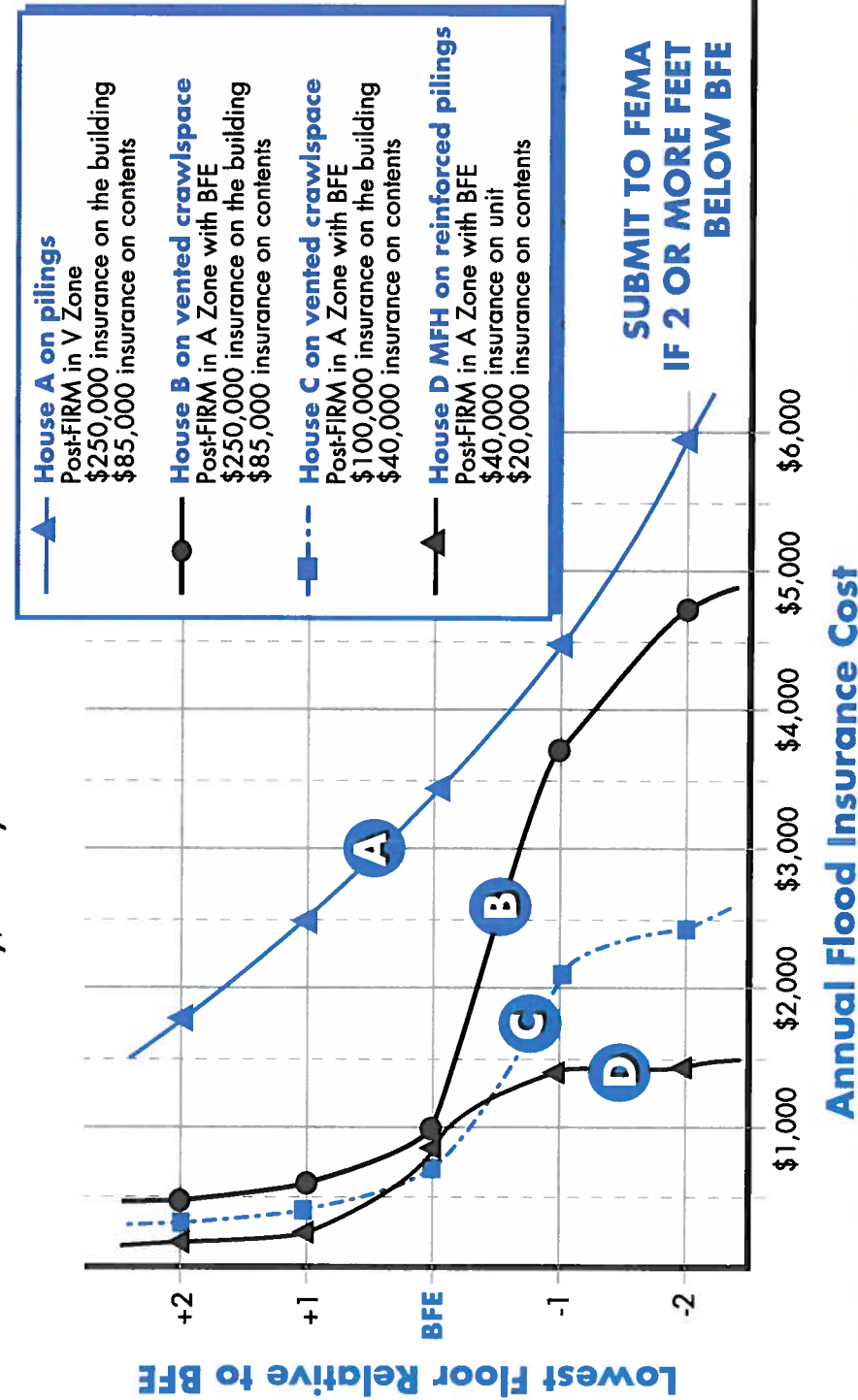

Important

Information

NOTE: Flood insurance rates and various fees change from time to time. Rather than specific costs for insurance, this figure gives a feel for how much difference just a foot or two can make.

Building owners will save insurance money if they elevate above the BFE. But more impressive is how the cost of insurance can more than double if the building is only one foot below the BFE.

Remember!

The community may be able to grant a variance, but the owner will probably still be required to buy insurance. Imagine trying to sell a house if the bank requires insurance that costs over \$2,000 a year!

What is the Elevation Certificate and How is it Used?

- The Elevation Certificate (EC) is a FEMA form. Go to <http://www.fema.gov/library/> and search on "Elevation Certificate."
- The EC must be completed and sealed by a registered surveyor or engineer when the floodplain has BFEs.
- A community official may complete the EC for sites in approximate flood zones.
- It can be used to show that sites are natural ground above the Base Flood Elevation (see page 21).
- It is used to verify that buildings are elevated properly (see page 30).
- Insurance agents use the EC to write flood insurance policies.

By itself, the EC cannot be used to waive the requirement to get flood insurance. See page 18 to learn about Letters of Map Amendment.

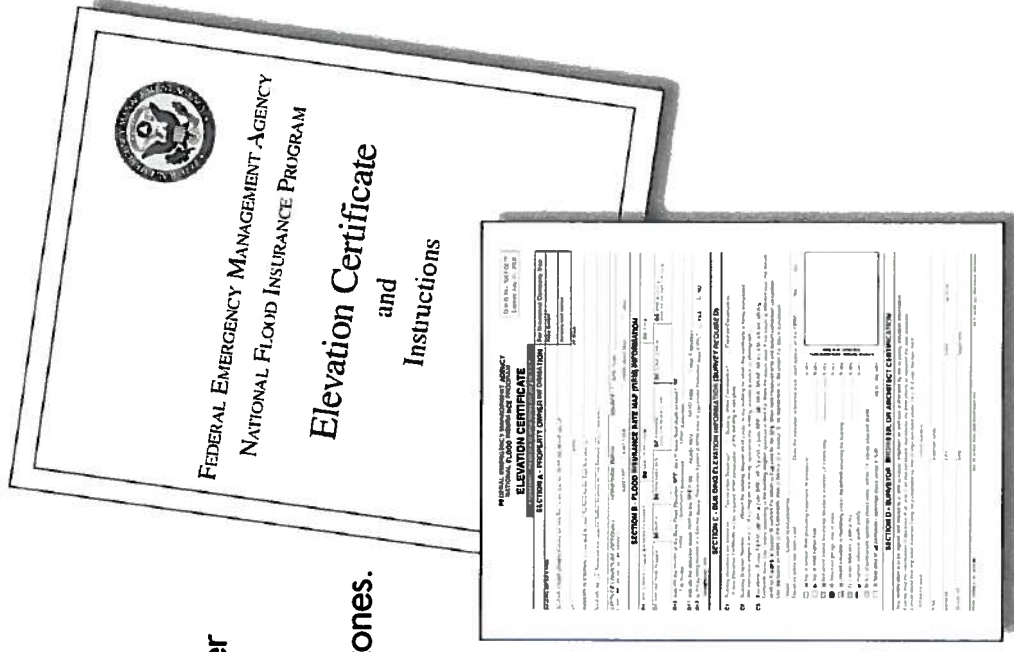

Completing the Elevation Certificate

Elevation Certificate (partial)

ELEVATION CERTIFICATE (partial) Important: Read the instructions on pages 1-7

SECTION C - BUILDING ELEVATION INFORMATION (SURVEY REQUIRED)

Elevation reference mark used None. Does the elevation reference mark used appear on the FIRM? Yes No

- a) Top of bottom floor (including basement or enclosure) 286 ft. (m)
- b) Top of next higher floor N/A ft. (m)
- c) Bottom of lowest horizontal structural member (V zones only) N/A ft. (m)
- d) Attached garage (top of slab) 282.5 ft. (m)
- e) Lowest elevation of machinery and/or equipment servicing the building 286 ft. (m)
- f) Lowest adjacent grade (LAG) 282.5 ft. (m)
- g) Highest adjacent grade (HAG) 286 ft. (m)
- h) No. of permanent openings (flood vents) within 1 ft. above adjacent grade NINE
- i) Total area of all permanent openings (flood vents) in C3h 1280 sq. in. (sq. cm)

License Number, Embossed Seal

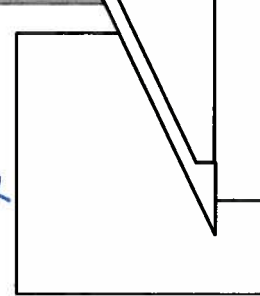

In this example, the BFE is 285.

The slab-on-grade house was elevated on fill 1' above the BFE, and the vented garage is 2.5' below the BFE.

You will get a blank Elevation Certificate form when you get your permit. You **must** have a surveyor or engineer fill it out and seal it. The Elevation Certificate includes diagrams for eight building types. Several points must be surveyed.

Paperwork is Important – for You and Your Community

Lowest Floor means the lowest floor of the lowest enclosed area (including basement). An unfinished or flood resistant enclosure (that is not a basement) is not the lowest floor if the enclosure is built as required in the local ordinance (see page 37), which includes limited uses.

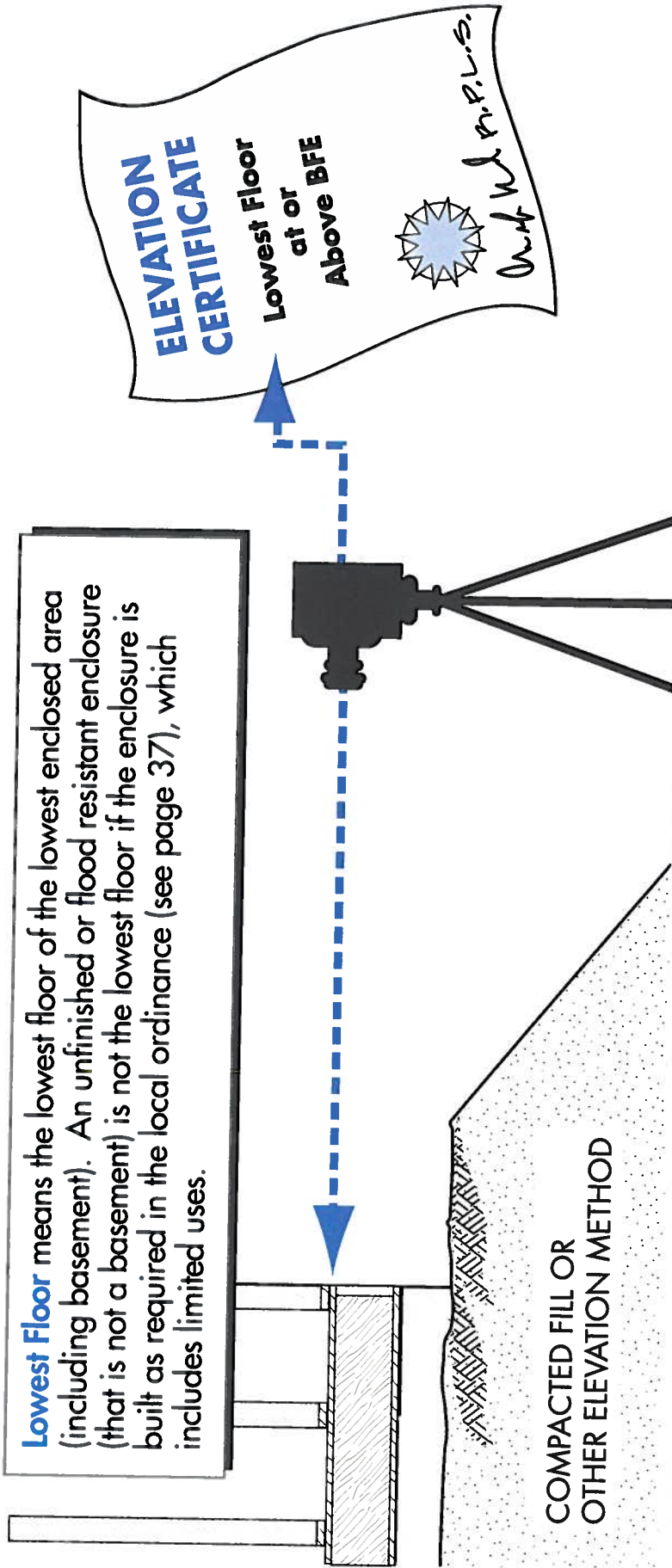

If you get a permit to build in the floodplain, you will be given an Elevation Certificate form. As soon as your lowest floor is set, get the form filled out and sealed by a surveyor or engineer.

This form is important!

If it proves that you built correctly, and it can be used to get the lowest cost flood insurance.

Floodplain Fill Can Make Things Worse

Floodplains are supposed to store floodwater. If storage space is filled with dirt and other fill, future flooding may be worsened. Your community may require an engineering analysis ("no rise" certificate) to show how floodplain fill will alter flooding. Floodplain fill can alter valuable floodplain functions, including wildlife habitat and wetlands.

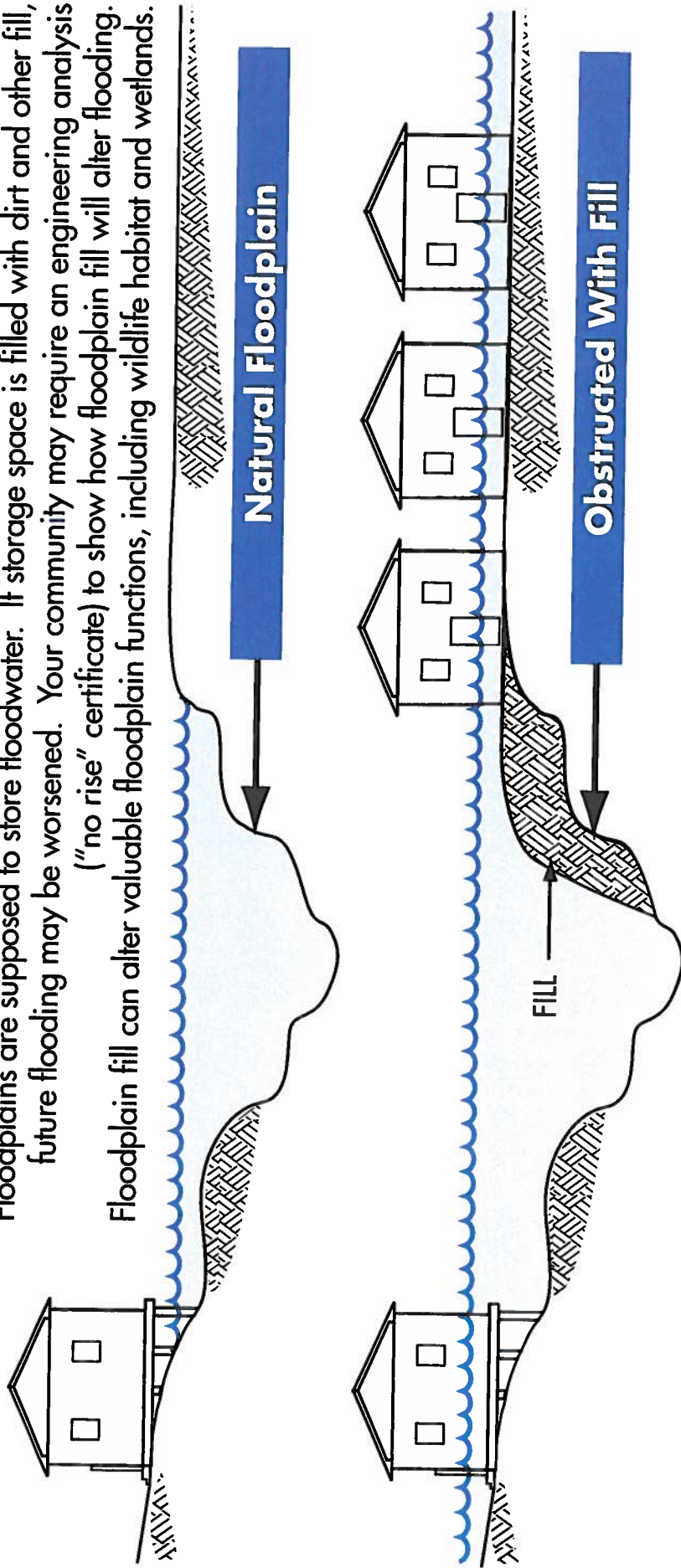

Make sure your floodplain fill project won't harm your neighbors. Floodway fill is allowed **only** if an engineering evaluation demonstrates that "no-rise" in flood level will occur (see page 32).

Recommended Floodway “No Rise” Certification

- Floodways can be dangerous because water may flow very fast
- Development is not allowed unless “no rise” in flood levels is certified
- An engineer must evaluate the hydraulic impact of proposed development
- A “no rise” certification is recommended and must be signed, sealed, and dated by a registered professional engineer
- Check with your community for guidance **before** you decide to work in a floodway

ENGINEERING “NO-RISE” CERTIFICATION (*example*)



This is to certify that I am a duly qualified engineer licensed to practice in the State of Texas. It is to further certify that the attached technical data supports the fact that proposed (**Name of Development**) will not impact the Base Flood Elevations (100-year flood), floodway elevations and the floodway widths on (**Name of Stream**).

Signature _____

Seal _____

The engineering analysis must be based on technical data obtained from FEMA.
Save time and money – don’t build in the floodway!

How to Elevate Your Floodplain Building (A Zone)

Elevate on Foundation Walls

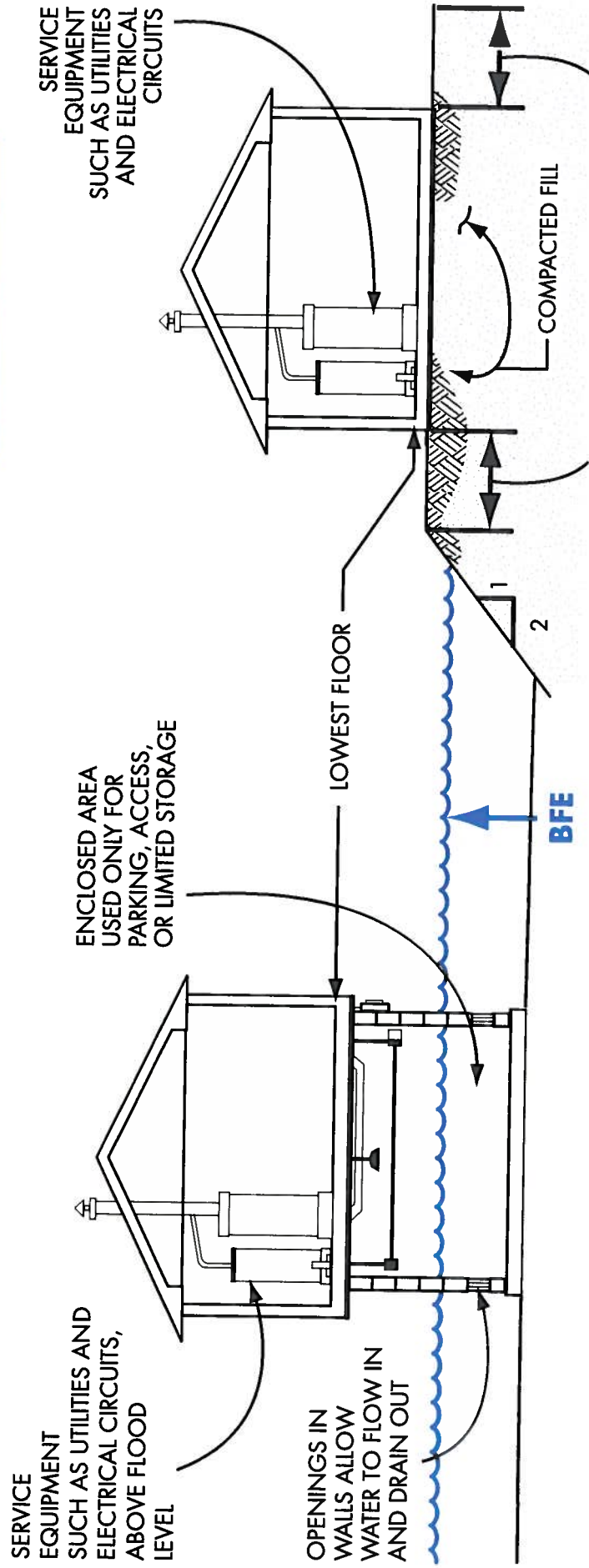

CAUTION! Enclosures (including crawlspaces) have some special requirements, see page 37. Note: When the walking surface of the lowest floor is at the minimum elevation, under-floor utilities are not allowed. Fill used to elevate buildings must be placed properly (see page 34). See page 38 to learn about elevating buildings in V Zones.

Elevate on Fill

Compaction of Floodplain Fill (A Zone)

Earthen fill used to raise the ground above the flood elevation must be placed properly so that it does not erode or slump when water rises. For safety and to meet floodplain requirements, floodplain fill should:

- Be good clean soil, free of large rocks, construction debris, and woody material (stumps, roots)
- Be machine compacted to 95 percent of the maximum density (determined by design professional)
- Have graded side slopes that are not steeper than 1:1.5 (one foot vertical rise for every 1.5 feet horizontal extent)
- Have slopes protected against erosion (vegetation for "low" velocities, durable materials for "high" velocities – determined by design professional)

Note: Fill **may not** be used to elevate a building in V Zones!

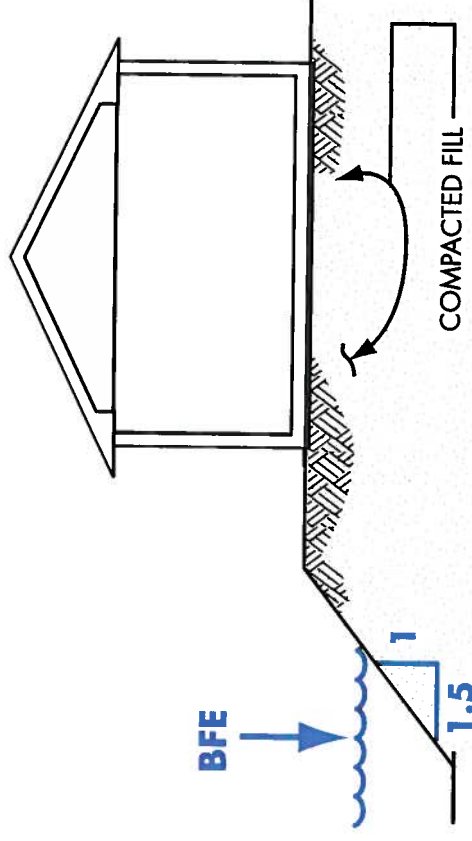

Your community may ask for certification of the elevation, compaction, slope, and slope protection materials. Your engineer or design professional can find more information in FEMA's technical guidance (MT-1).

Basements Are Unsafe

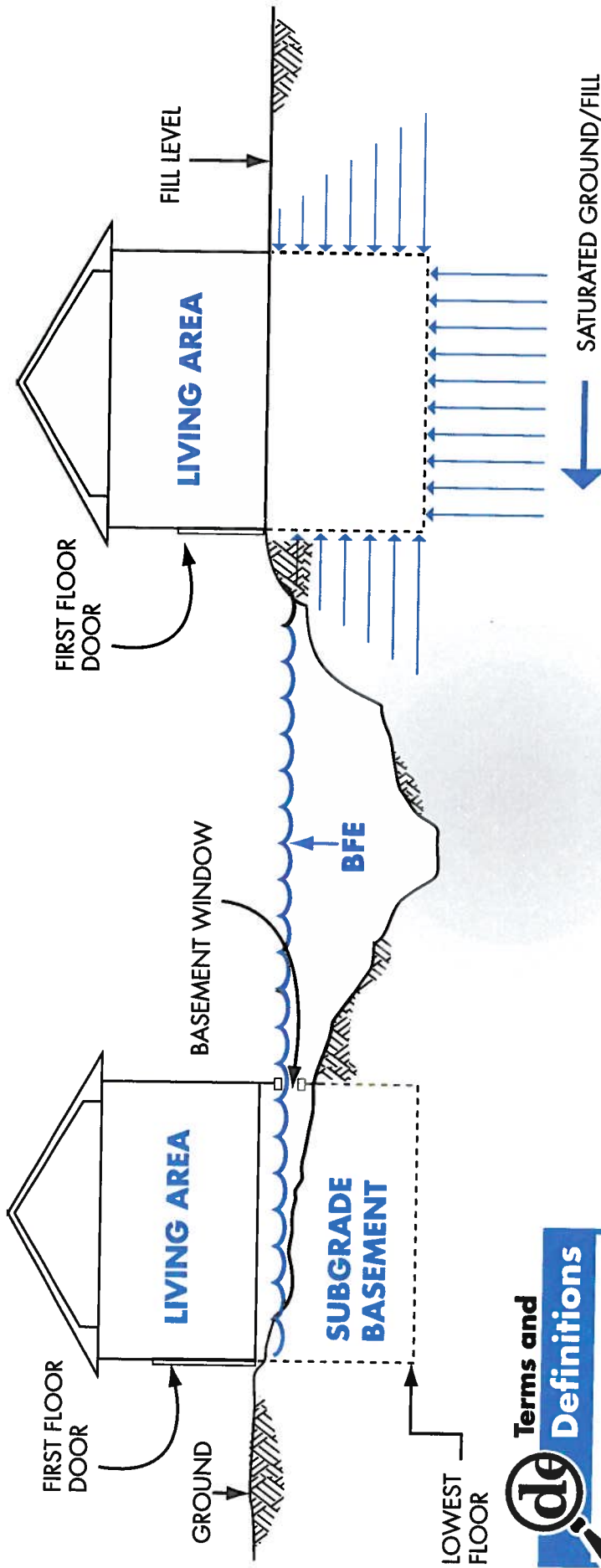

Terms and Definitions

A **basement** is any portion of a building that has its floor subgrade (below ground level) on all sides.

Basements below the BFE are not allowed in new development and flood insurance coverage is very limited in existing basements for a very good reason. It only takes an inch of water over the sill and the entire basement fills up! Excavating a basement into fill doesn't always make it safe because saturated groundwater can damage the walls.

Manufactured Homes Deserve Special Attention

Experience shows that manufactured homes are easily damaged. As little as one foot of water can cause substantial damage.

Dry stacked blocks are not acceptable — they will **NOT** withstand a flood.

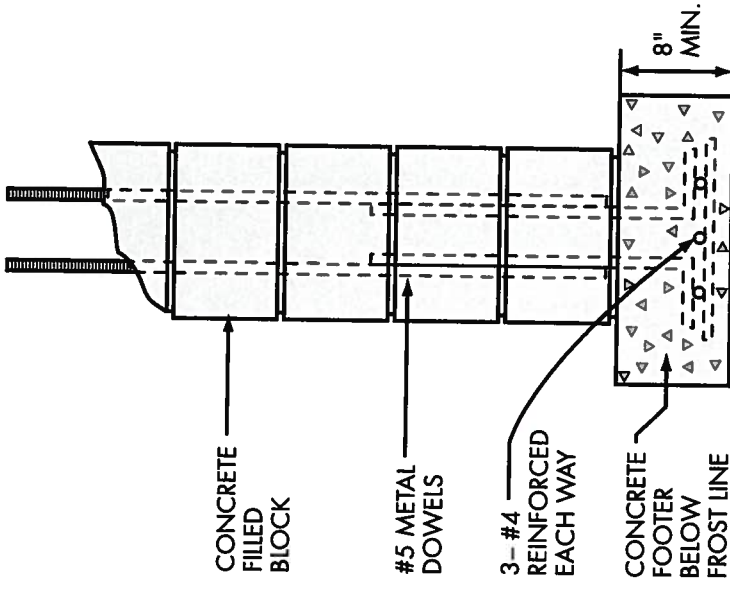
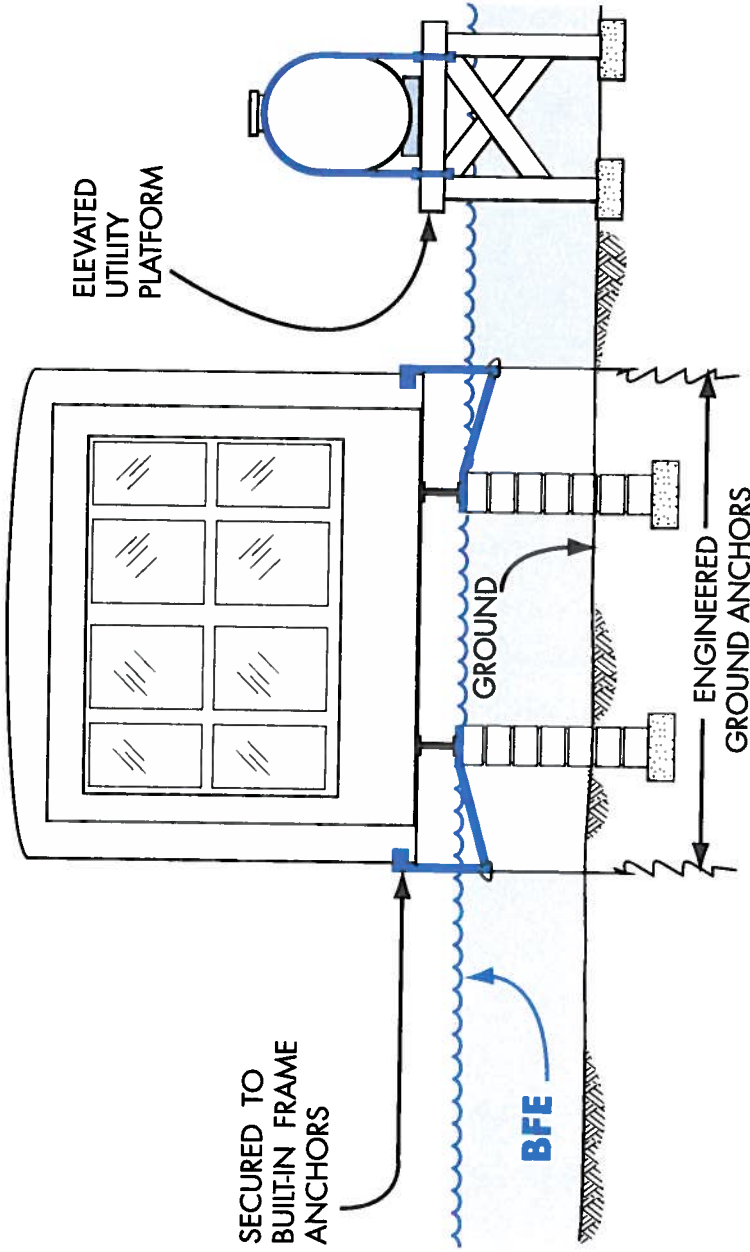

Manufactured homes must be anchored to resist flotation, collapse, or lateral movement by being tied down in accordance with your community's ordinance or the manufacturers' installation specifications.

Enclosures Below the BFE (A Zone Only)

NOTE:

- AREA OF ALL TOTAL OPENINGS IS 1 SQ. IN. PER SQ. FT. OF ENCLOSED AREA
- A 25' X 45' BUILDING NEEDS 1125 SQ. INCHES OF OPENINGS
- STANDARD VENTILATION UNITS USED IN BLOCK FOUNDATION WALLS MUST BE DISABLED IN THE OPEN POSITION TO ALLOW WATER TO FLOW IN AND OUT
- A STANDARD VENTILATION UNIT, WITH SCREEN, PROVIDES 42 SQ. INCHES OF OPENING

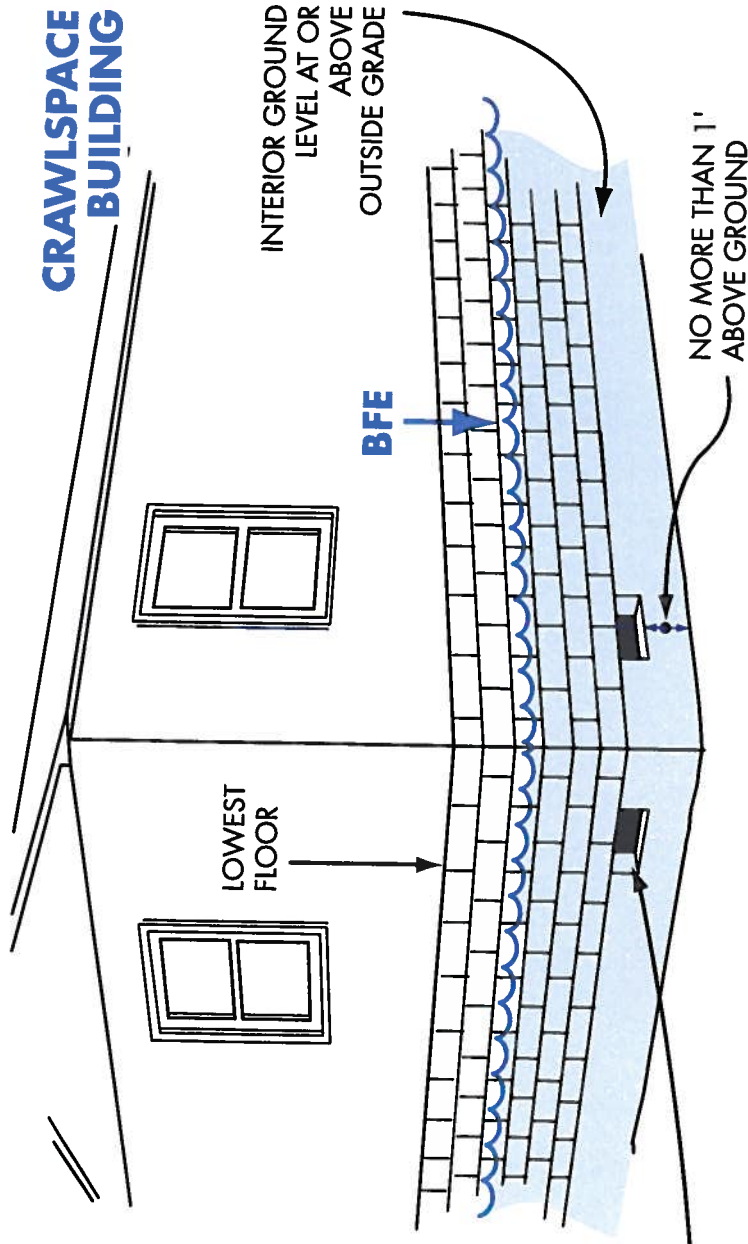

AT LEAST TWO FLOOD OPENINGS ON DIFFERENT SIDES

Solid perimeter wall foundations can enclose flood-prone space. A crawlspace is a good way to elevate just a couple of feet. In all cases, the following are required: openings/vents, elevated utilities, flood resistant materials, and limitations on use.

Typical Elevation Methods for Coastal Buildings

Elevate on Pilings

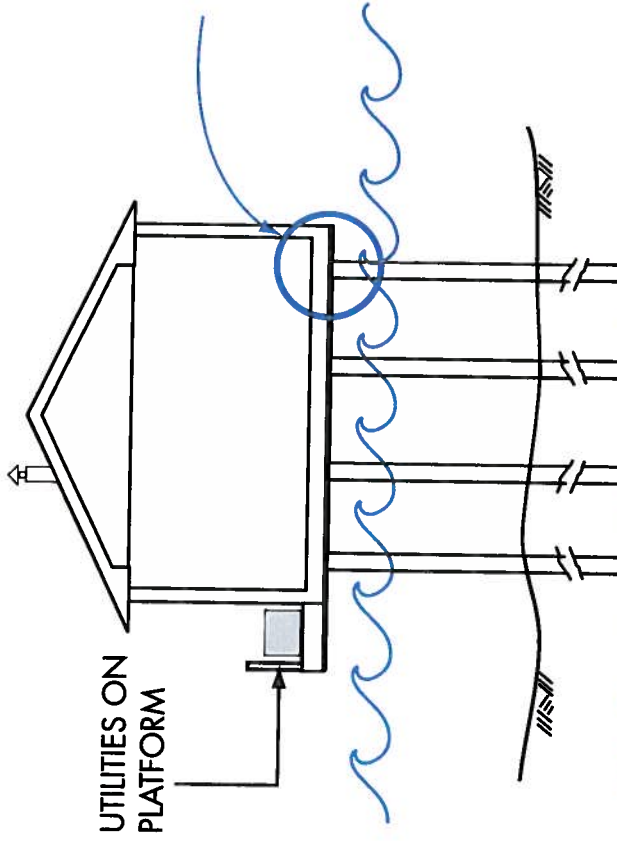

Wood or Metal Piles Installed to Proper Depth

Elevate on Columns

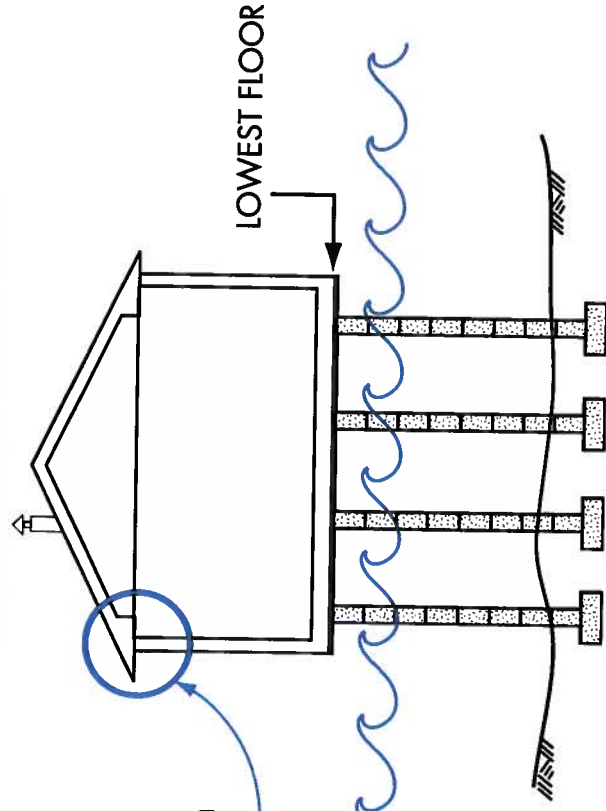

Reinforced Masonry or Concrete Columns on Spread Footers

See details on page 39

In V Zones the design specifics will be determined by your architect or engineer based on your site, including how your building will be elevated and how deep in the ground the foundation elements will extend. Your community will require certified or sealed building designs and plans (see page 40).

Coastal Houses Must Resist Wind and Water Forces

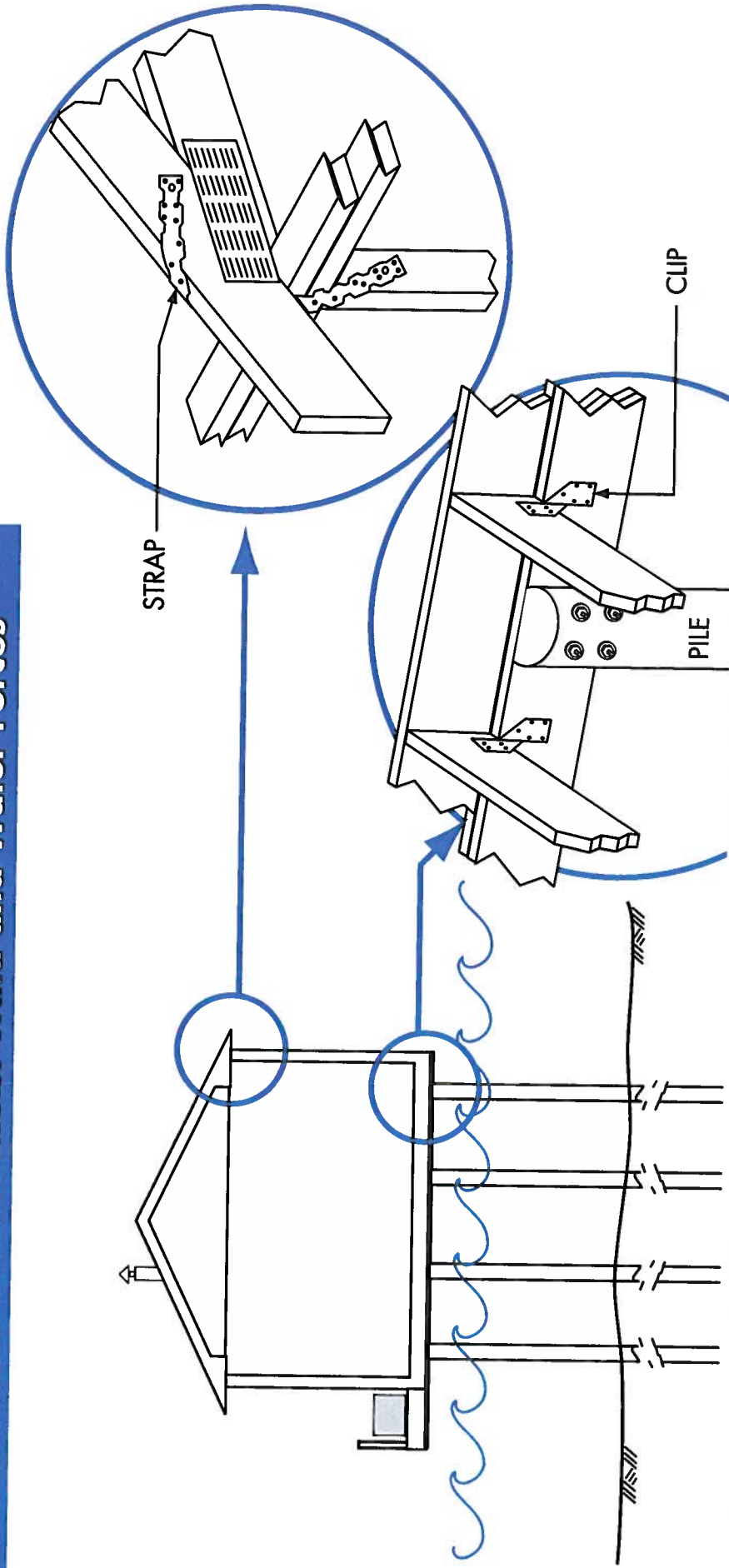

Coastal buildings may be exposed to both hurricane winds and floodwater, so they must be built to hold together during storms. These details are only examples. Your architect or engineer will decide the type of clips and straps to keep the roof and building connected to the foundation.

The V Zone Certificate (Sample)

V Zone Building Design and Performance Certificate (partial)

Section 2: Elevation Information

1. Elevation of the Bottom of the Lowest Horizontal Structural Member..... 17 feet
2. Base Flood Elevation (BFE)..... 16 feet
3. Elevation of Lowest Adjacent Grade (LAG)..... 6 feet
4. Foundation type: Piling Post Pier Column Fill Shear Wall Enclosed Wall
Foundation Description: DRIVEN WOOD PILES, NO OBSTRUCTIONS EXCEPT OPEN STAIRS
5. Approximate depth of scour/erosion used for foundation design..... 3 feet
6. Embedment depth of pilings or foundation below LAG..... 16 feet

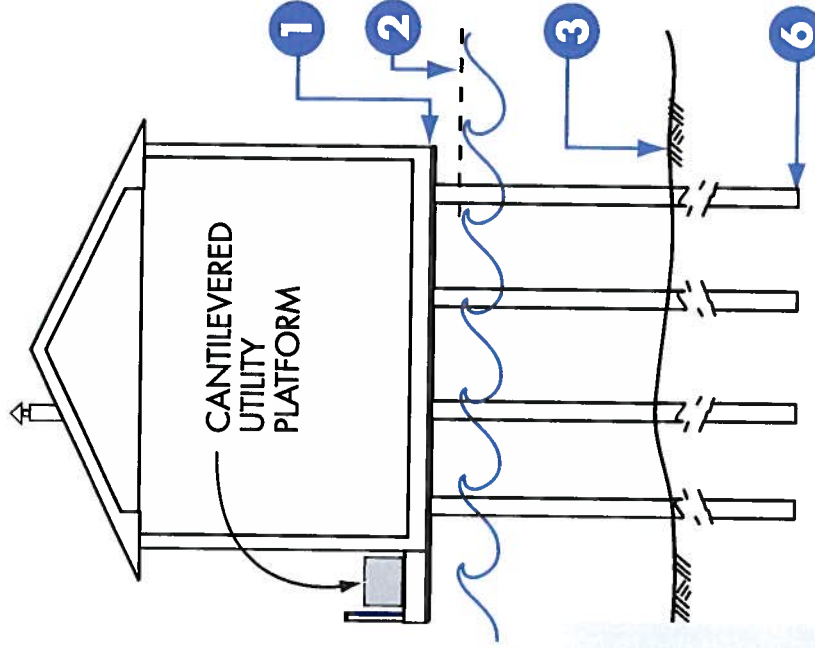

A Registered Professional Engineer or Architect must review or prepare your building design and provide a signed and sealed statement that the design meets minimum design and construction requirements.

Resource: *Coastal Construction Manual (FEMA 55CD)*. Revised in 2000, this interactive CD is a useful tool for engineers and architects who design buildings in V zones.

Enclosures Below V Zone Buildings

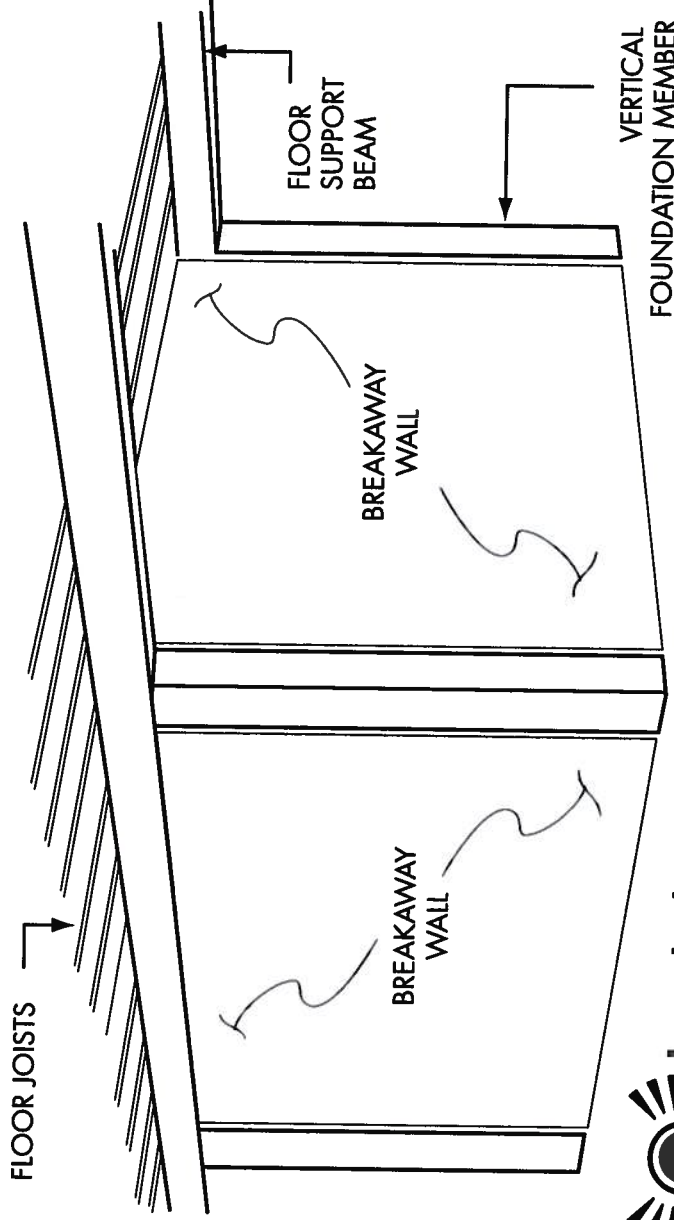

Important

Information

Do not modify an enclosure below an elevated V Zone building (or any zone for that matter)! It is a violation of your community's regulations, and you may have increased damage when it floods. Plus, your flood insurance policy will cost a lot more!

Avoid building an enclosure under your V Zone building. If you must enclose a small area, your community will require:

- Walls must be designed to collapse or "breakaway" under storm and flood conditions
- Flood resistant materials
- Utility wires and pipes should not go through or be attached to the breakaway walls
- Enclosed area is to be used only for parking, building access, or storage
- No bathrooms, utility rooms, or electric service below BFE
- Size limited to 300 square feet in some communities

Utility Service Outside Buildings

**Heat Pump or A/C
on Platform**

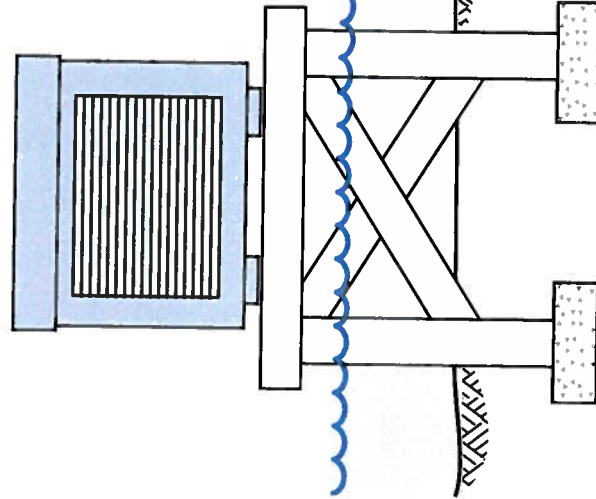

**Fuel or Propane Tank
Anchored on Platform**

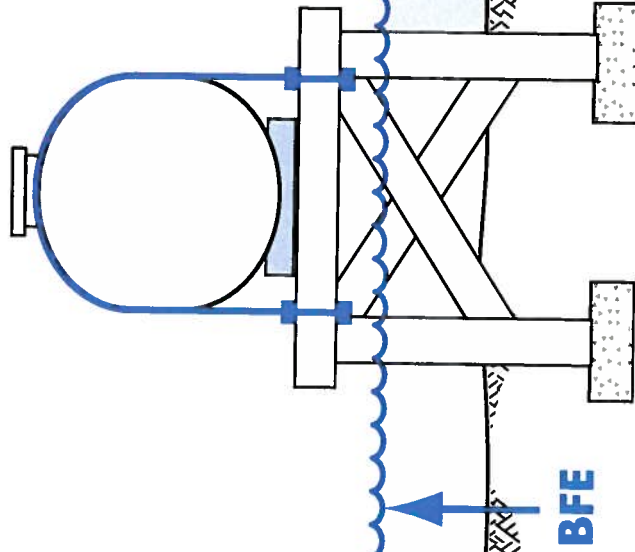

Important

Information

Fuel and propane tanks may cause explosion and pollution risks during flood conditions! Even shallow water can create large buoyant force on tanks, so extra care must be taken to ensure that all tanks are anchored.

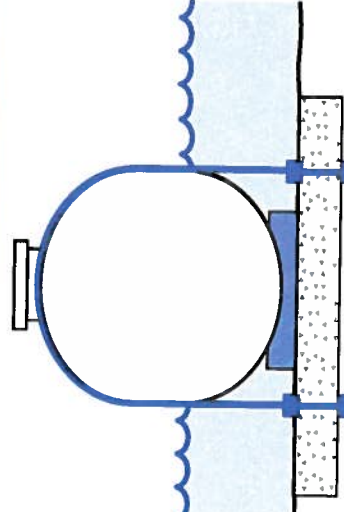

**Fuel or Propane Tank
Anchored to Prevent Flotation**

Whether inside an attached garage or outside the building, all utilities, appliances and equipment must be elevated above the BFE or protected against flood damage. Utilities include plumbing, electrical, gas lines, fuel tanks, and heating and air conditioning equipment.

Utility Service Inside Enclosures

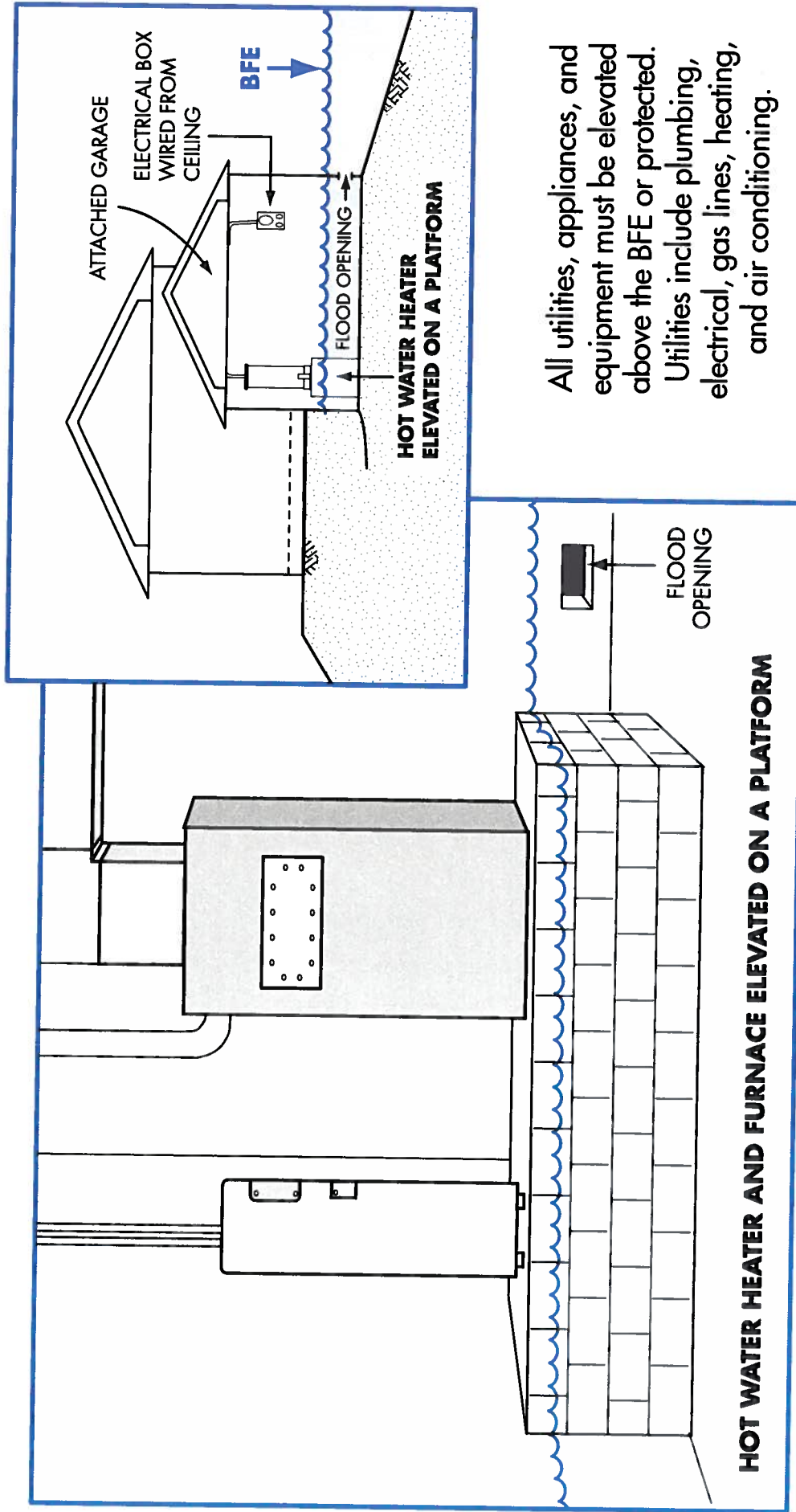

All utilities, appliances, and equipment must be elevated above the BFE or protected. Utilities include plumbing, electrical, gas lines, heating, and air conditioning.

Accessory (Appurtenant) Structures

- Not habitable
- Anchored to resist floating
- Flood openings/vents
- Built of flood resistant materials
- Elevated utilities
- Used only for storage or parking
- Cannot be modified for different use in the future
- Document floor elevation

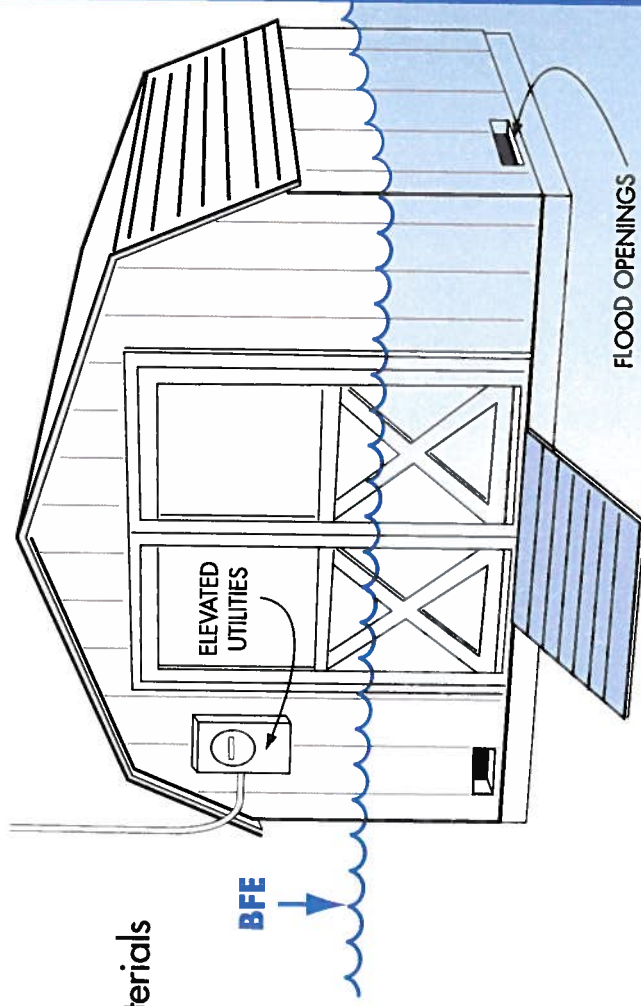

Even small buildings are “development” and permits or variances with noted conditions are required. They must be elevated or anchored and built to withstand flood damage. **Caution!** Remember, everything inside is likely to get wet when flooding occurs.

de Terms and Definitions

Accessory

(Appurtenant)

Structure means a structure that is located on the same parcel of land as a principle structure and whose use is incidental to the use of the principle structure. Accessory structures should be no more than a minimal initial investment, may not be used for human habitation, and must be designed to minimize flood damage.

Examples: detached garages, carports, storage sheds, pole barns, and hay sheds.

Recreational Vehicles

In a flood hazard area, an RV must:

- Be licensed and titled as an RV or park model (not as a permanent residence)
- Be built on a single chassis
- Have inflated wheels and be self-propelled or towable by light truck
- Have no attached deck, porch, shed
- Be used for temporary recreational, camping, travel, or seasonal use (no more than 180 days)
- Be less than 400 sq ft in area (measured at largest horizontal projection)
- Have quick-disconnect sewage, water, and electrical connectors

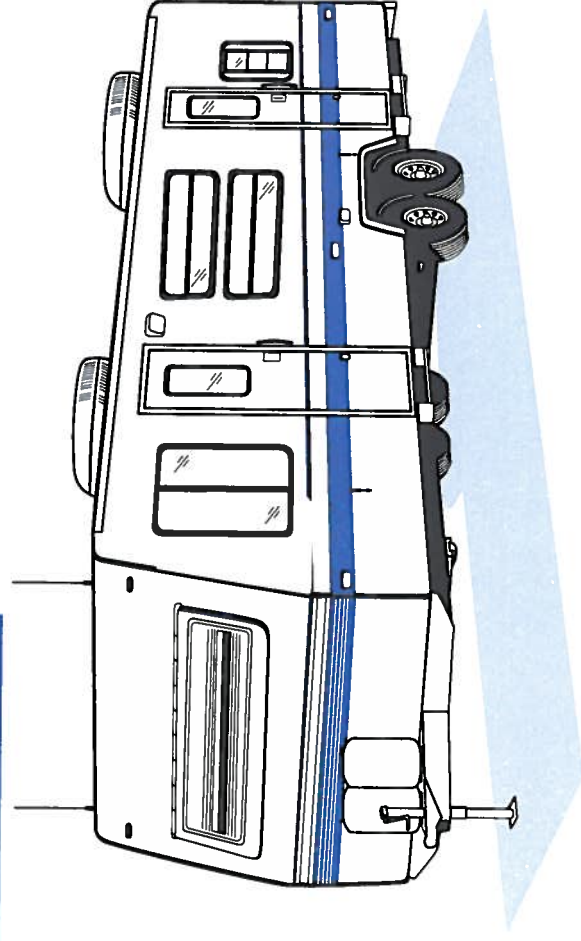

Important Information

Camping near the water?

Ask the campground or RV park operator about flood warnings and plans for safe evacuations.

RVs that do not meet these conditions must be installed and elevated like Manufactured Homes, including permanent foundations and tie-downs (see page 36).

Planning to Improve Your Floodplain Building?

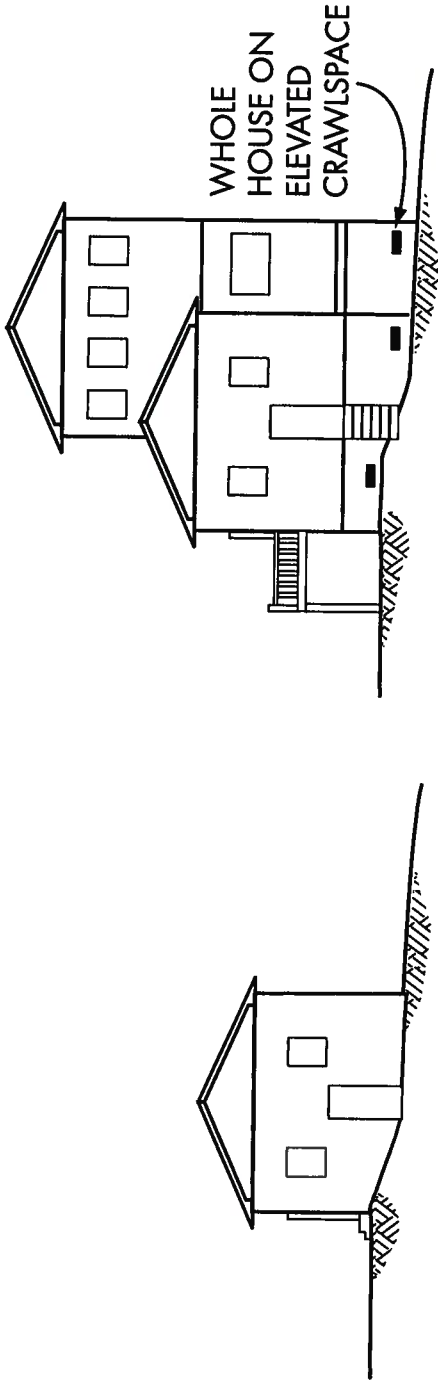

Before Improvements
Building Market Value = \$110,000

After Improvements
Cost of Improvements = \$68,500

Terms and Definitions

Substantial improvement means any reconstruction, rehabilitation, addition, or other improvement of a structure, the cost of which equals or exceeds 50 percent of the market value of the structure before the start of construction of the improvement. This term includes structures which have incurred substantial damage, regardless of the actual repair work performed (see page 47).



Important

Information

Floodplain buildings can be improved or altered, but special rules may apply!

If the cost of an addition to a Pre-FIRM structure is less than 50% of its market value, only the addition is required to be built above the BFE. Check with your local permit office.

The cost to correct previously cited violations of state or local health, sanitary, or safety code to provide safe living conditions can be excluded.

Alteration of a registered historic structure is allowed, as long as it will continue to meet the criteria for listing as a historic structure.

What About After Damages?

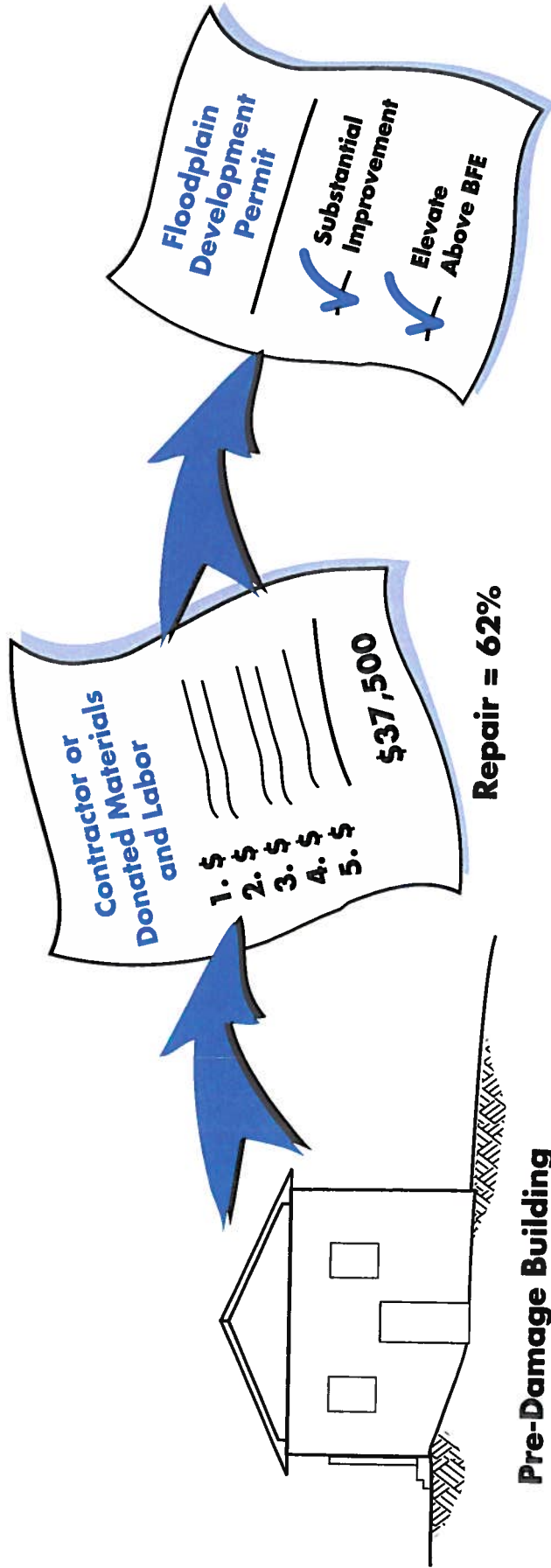

Permit/Elevation Required

A permit is required to repair substantial damage from any cause — fire, flood, wind, or even a truck running into a building. Check with your community permit office to be sure.

You will be asked to provide a detailed cost estimate for repairs.

See page 48 for more information about elevating an existing building on a crawlspace.

Elevating a Pre-FIRM Building

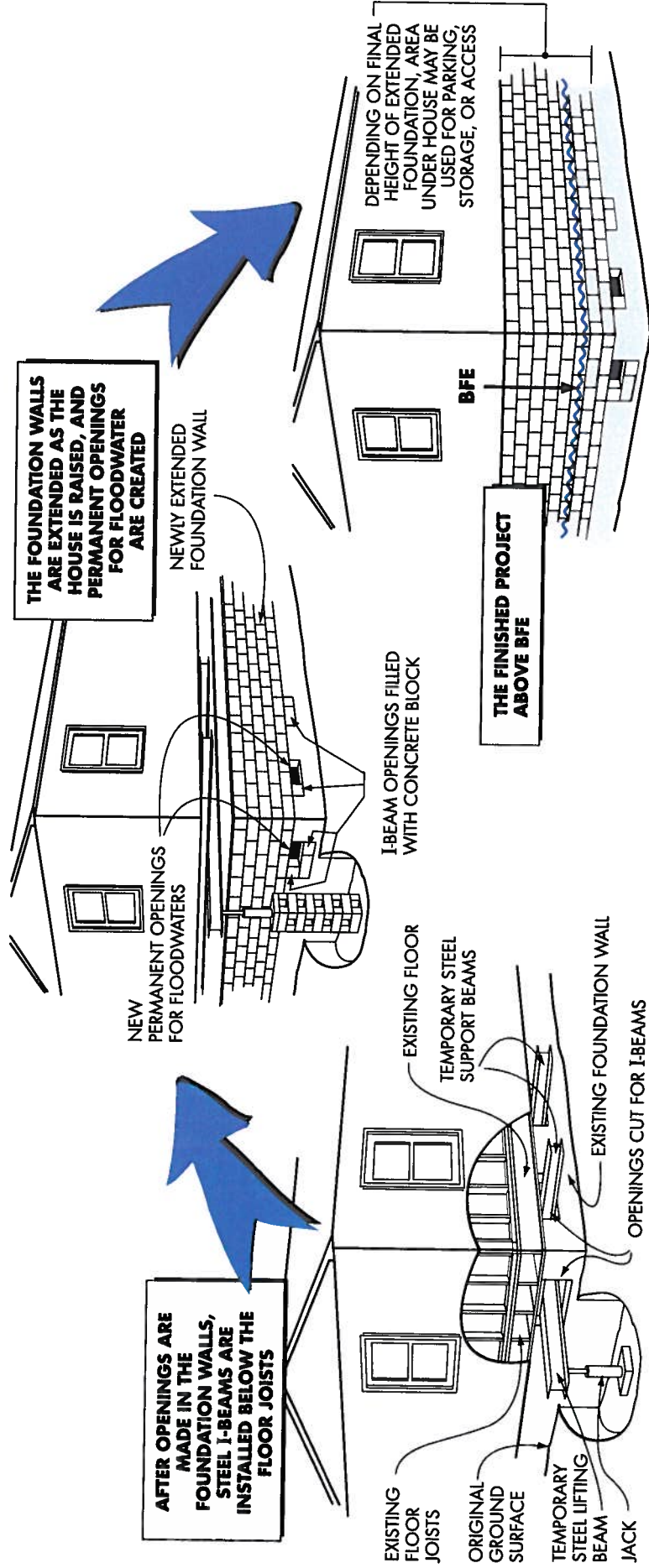

This is one way to elevate an existing building to comply with floodplain regulations. If your insured building is damaged by flood, you may be eligible for an increased Cost of Construction payment. The state and FEMA can help with more information and options.

Some Flood Protection for Older Homes is Easy and Low Cost

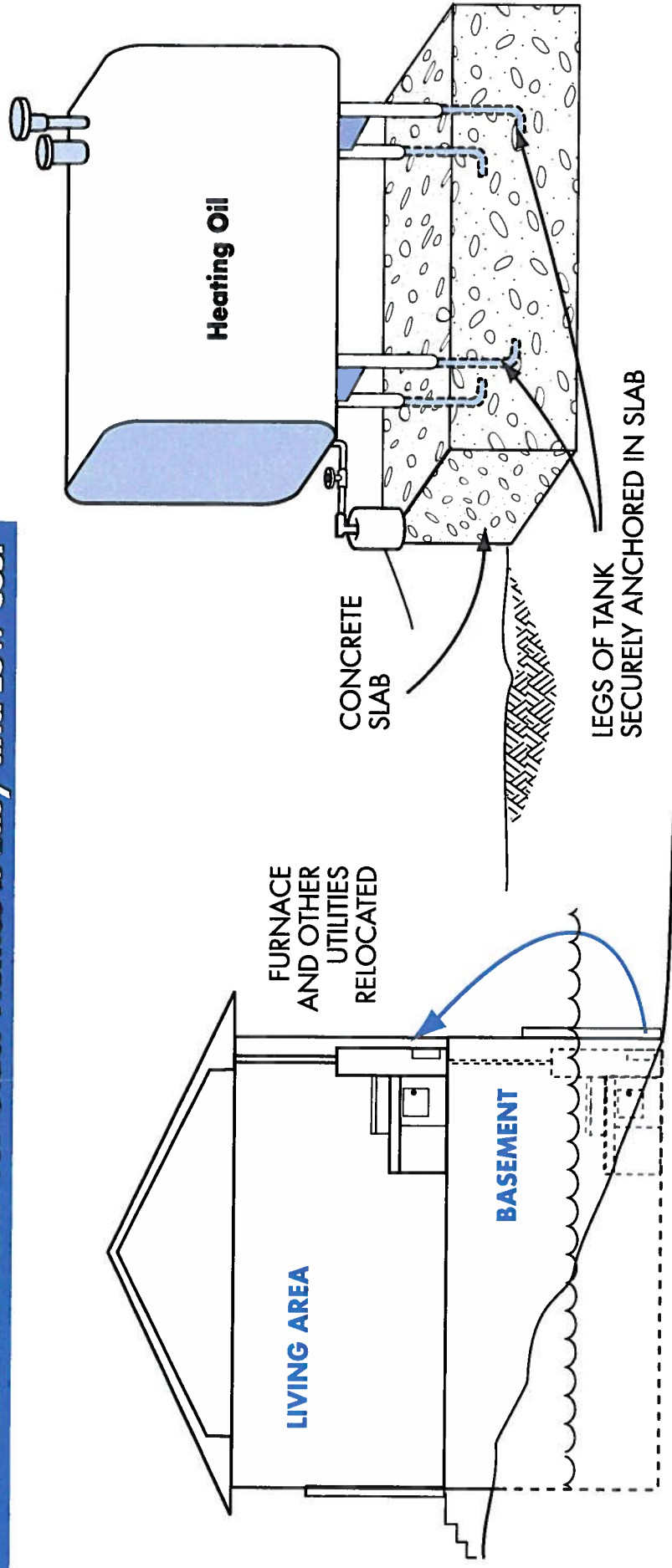

Move your hot water heater and furnace out of the basement, or build small platforms for them. If the flood depth is less than 2 feet, build floodwalls or anchor the tanks.

Do not store valuables in a flood-prone basement.
Use water-resistant materials when you repair.

Small Levees and Floodwalls Can Protect Some Older Homes

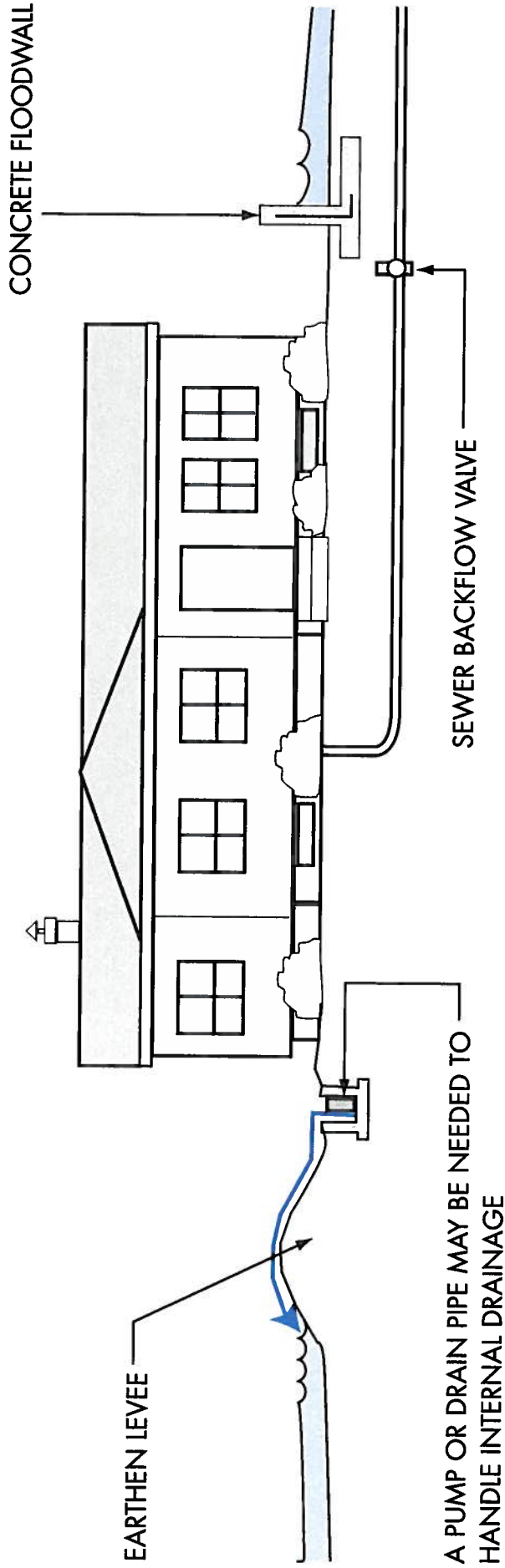

In areas where floodwaters aren't expected to be deep, sometimes individual buildings can be protected by earthen levees or concrete floodwalls. You must get a permit for those protection measures, and extra care must be taken if the site is in a floodway (see pages 10, 31 and 32). A levee or floodwall cannot be used to protect a new or substantially improved building, or one that is repaired after substantial damage.

Important! These protective measures will not reduce your flood insurance premium!

Some Flood Mitigation Projects are More Costly

But Give You More Protection

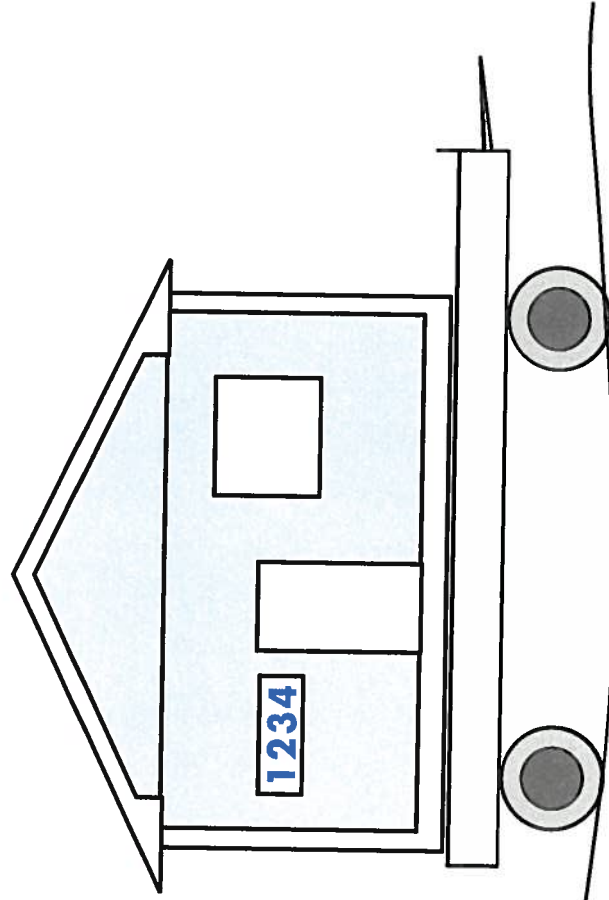
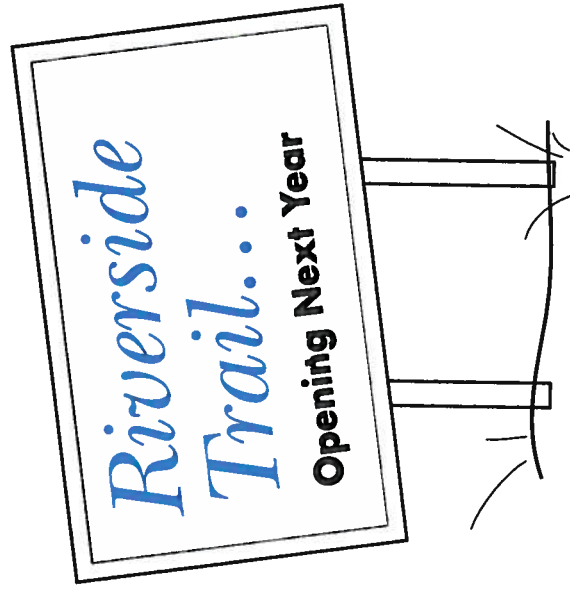

After floods, some communities buy out and demolish homes that were severely damaged. The acquired land is dedicated to open space and can be used for recreation or to help restore wildlife habitat and wetlands. Homes have been raised up on higher foundations, and others have been moved to safer high ground.

Useful Resources and Common Acronyms

Useful Resources

- For information on disaster safety, being prepared, and repairing homes, visit the American Red Cross webpage at <http://www.redcross.org/services/disaster>.
- FEMA has developed materials to help families and businesses learn more about preparing for floods and recovering from disasters at <http://www.fema.gov/library>.
- Texas Floodplain Management Association: <http://www.tfma.org>
- Texas Commission on Environmental Quality: <http://tceq.state.tx.us>
- Texas Department of Insurance: <http://tdi.state.tx.us>
- Texas General Land Office: <http://www.glo.state.tx.us>

Common Acronyms

- BFE = Base Flood Elevation
- EC = Elevation Certificate
- FEMA = Federal Emergency Management Agency
- FIRM = Flood Insurance Rate Map
- MFH = Manufactured Housing Unit
- NFIP = National Flood Insurance Program
- SFHA = Special Flood Hazard Area
- TCEQ = Texas Commission on Environmental Quality
- TFMA = Texas Floodplain Management Association

Want to Learn More?

- For advice on flood information and permits, call your community's building permit office or planning department.
- To order Flood maps, call FEMA's Map Service Center — **1 (800) 358-9616** or order on-line at <http://web1.msc.fema.gov/MSCL>
- To learn more about flood maps and to check the Status of Map Change Requests, click on "Flood Hazard Mapping" at <http://www.fema.gov/fima/>.
- You can order printed copies of FEMA publications from the FEMA Distribution Center. To place an order, call **1(800) 480-2520**.
- FEMA's on-line publications can be found in the FEMA Virtual Library. Many are posted in the Portable Document Format (PDF). Go to <http://www.fema.gov/library/> for more information.
- To learn about flood insurance, call your insurance agent. Most insurance companies can write an NFIP policy for you. If you need more help, call the National Flood Insurance Program's toll free number to get the name of an agent in your area who does write flood insurance. The number is **1(888) FLOOD29**.
- To get the best rates for flood insurance, call a local surveyor to complete an Elevation Certificate.
- To access Elevation Certificate training for surveyors, go to <http://training.nfipstate.com/ecsurveyor/>.