

CITY OF HOUSTON DEPARTMENT OF PUBLIC WORKS AND ENGINEERING

INFRASTRUCTURE DESIGN MANUAL

**DANIEL W. KRUEGER, P.E.,
DIRECTOR**

**CARL W. SMITHA, P.E.,
CITY ENGINEER**

REFERENCE GUIDE

ROADWAY CROSS SECTION (FEET)		TAPER (FEET)
A + A	B + B	WS^2
80	60	$L = \frac{60}{S}$
80	40	150
80	27	300
70	40	400
70	27	225
60	40	325
60	27	150
60	40	250
60	27	100
40	27	

10-17
10-02



JULY 2012





CITY OF HOUSTON

Public Works and Engineering Department

Annise D. Parker

Mayor

Daniel W. Krueger, P.E.
Director
P.O. Box 1562
Houston, Texas 77251-1562

www.houstontx.gov

July 1, 2012

TO WHOM IT MAY CONCERN:

The 2012 edition of the City of Houston Infrastructure Design Manual is issued by the Public Works and Engineering Department with a publication date of July 1, 2012. The manual has been primarily updated and revised to reflect changes to traffic and signal design requirements.

Per the Engineering and Construction Division of the Public Works and Engineering Department, Capital Improvement Project Designs that have not reached the 50% design submittal stage by July 1, 2012, will be required to comply with all standards in the 2012 Infrastructure Design Manual.

Projects in the public/private sector that submit plans for review and/or permitting **AFTER July 31, 2012** will be required to comply with all standards in the 2012 Infrastructure Design Manual.

Questions regarding the changes to the manual or other concerns can be submitted via email to: standardreviewcommittee@houstontx.gov.

Respectfully,

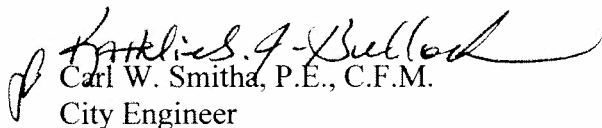
Carl W. Smitha, P.E., C.F.M.
City Engineer

CS:RA:sl

c: Daniel W. Krueger, P.E.

**City of Houston
Department of Public Works and Engineering**

**INFRASTRUCTURE
DESIGN MANUAL**

JULY 2012

TABLE OF CONTENTS

<u>Chapter</u>	<u>No. of Pages</u>
1 General Requirements.....	8
2 Survey Requirements.....	7
3 Graphic Requirements	14
4 Platting Requirements.....	6
5 Easement Requirements.....	6
6 Utility Locations	6
7 Water Line Design Requirements	18
8 Wastewater Collection System Design Requirements.....	15
9 Storm Water Design Requirements	25
10 Street Paving Design Requirements.....	42
11 Geotechnical Requirements	30
12 Street Cut Requirements	3
13 Storm Water Quality Design Requirements	18
14 Facility Design Requirements.....	1
15 Traffic and Signal Design Requirements.....	97
16 Miscellaneous	7

City of Houston
Department of Public Works and Engineering

INFRASTRUCTURE
DESIGN MANUAL

JULY 2012

LIST OF FIGURES

<u>Figure</u>	<u>Page</u>
2.1 Perimeter of Standard Topographical Survey.....	2-7
3.1 Existing Improvements	3-5/3-9
3.2 Proposed Improvements.....	3-10/3-13
3.3 Line Code Definitions.....	3-14
4.1 Class III Preliminary Plats	4-5
4.2 Class III Final Plat (or Class II Plat).....	4-6
6.1 Typical Utility Locations in 10-foot-wide Residential Easement.....	6-5
6.2 Typical Utility Locations in 14-foot-wide Residential Easement.....	6-6
9.1 City of Houston IDF Curves.....	9-23
9.2 City of Houston Storm Sewer Calculation Form	9-24
9.3 City of Houston Roadside Ditch Worksheet.....	9-25
11.1 Piezometer Installation Report Format	11-18
11.2 Summary of Test Results Format	11-19
11.3 Boring Log	11-20
11.4 Boring Log Profile Format.....	11-21
13.1 Typical Bioretention Basin	13-14
13.1 Typical Rain Barrel.....	13-15
13.1 Porous Concrete Typical Section.....	13-16
13.2 Dry Swale Cross Section	13-17
13.3 Wet Swale Plan.....	13-18
15.4.1 Overview of Traffic Impact Analysis Process	15-6
15.4.2 Recommended Procedure for Estimating Trip Generation.....	15-9
15.4.3 Traffic Impact Analysis Preparation Overview	15-11
15.4.4 Mitigation Decision Tree	15-16
15.8.1 Driveway Radius and Width.....	15-31
15.8.2 Driveway Spacing.....	15-33
15.8.3 Driveway Placement	15-31
15.8.4 Turn Lane Details	15-36
15.15.1 Summarized NTMP Process	15-94

City of Houston
Department of Public Works and Engineering

INFRASTRUCTURE
DESIGN MANUAL

JULY 2012

LIST OF TABLES

<u>Table</u>	<u>Page</u>
7.1 Water Line Location within a Street Right-of-Way	7-4
7.2 Depth of Cover for Water Lines	7-5
7.3 Protection Requirements at Water Line - Sanitary Sewer Crossings	7-15
8.1 Minimum Grades for Wastewater Lines	8-10
8.2 Maximum Distance Between Sanitary Sewer Manholes	8-11
9.1 Standard Storm Sewer Inlets	9-10
10.1 Local Street Classification	10-6
10.2 Design Example	10-7
10.3 Required Intersection Sight Distance	10-8
11.1 Boring Spacing and Depth	11-9
15.4.1 Average Trip Generation Rates	15-4
15.4.2 Traffic Impact Categories	15-9
15.4.3 Boundaries and Horizon Guidelines	15-10
15.8.1 Driveway Design Criteria	15-29
15.8.2 Driveway Spacing Criteria	15-33
15.8.3 Non-Residential-Driveway Placement Criteria(1)	15-34

City of Houston

Design Manual

Chapter 1

GENERAL REQUIREMENTS

Chapter 1

GENERAL REQUIREMENTS

1.01 CHAPTER INCLUDES

- A. Research and submittal requirements for projects inside the city limits of Houston or within Houston's extraterritorial jurisdiction (ETJ).

1.02 REFERENCES

The following references should be reviewed in conjunction with this manual:

- A. Latest revision of the following City of Houston Code of Ordinances:
 - 1. Article IV Chapter 33, City Surveys
 - 2. Article V Chapter 40, Street and Sidewalk
 - 3. Chapter 42, Subdivisions, Developments and Platting
 - 4. Article V, Chapter 47, Water and Sewers
- B. Texas Accessibility Standards (TAS) of the Architectural Barriers Act, Article 9102, Texas Civil Statutes.
- C. City of Houston Standard Specifications and Standard Details, latest revision.
- D. Rules and Regulations published by Texas Commission on Environmental Quality (TCEQ).
 - 1. TCEQ, Water Supply Division, Rules and Regulations for Public Water Systems, latest revision.
 - 2. TCEQ, Design Criteria for Sewer Systems, Texas Administrative Code, latest revision.
- E. State of Texas Engineering Practice Act.
- F. State of Texas Professional Land Surveying Practices Act.
- G. Storm Water Management Handbook for Construction Activities, Latest Edition as Prepared by Harris County, Harris County Flood Control District (HCFCD), and City of Houston.
- H. Harris County Public Infrastructure Department's Rules and Regulations.

1.03 DEFINITIONS

- A. City Engineer - The authorized representative of the City, or his designee, having approval authority for privately-funded projects, or having authority for administration of design and construction contracts for the City.
- B. Review Authorities - The authorized representatives of City departments, divisions, branches or sections responsible for reviewing and approving calculations and drawings for privately-funded projects and for design and construction contracts with the City.
- C. Drawings - Plan, profile, detail, and other graphic sheets to be used in a construction contract which define character and scope of the project.
- D. Design Analysis - Narratives and calculations necessary to support design of a project.
- E. Professional Engineer - An engineer currently licensed and in good standing with the Texas Board of Professional Engineers.
- F. Professional Land Surveyor - A surveyor currently registered and in good standing with State of Texas Board of Professional Land Surveying.
- G. Specifications - City of Houston Standard Specifications plus project-specific narrative descriptions of procedures, requirements, and materials for a particular project.

1.04 PLAT AND CONSTRUCTION DRAWING REVIEW PROCESS

- A. Review of plat and construction drawings by the Department of Public Works and Engineering is a required part of the overall platting process under purview of the City Planning Commission and the Planning and Development Department of the City of Houston.
- B. The process to be followed in submitting documents for review and approval of water, wastewater, storm drainage, and street paving is described by the flowchart depicted in Figure 4.1, Review and Approval Process for Plats and Drawings.
- C. Utility and paving construction in projects requiring subdivision plats is not permitted until the final plat has been released. Plat release by Department of Public Works and Engineering is authorized by signature of the Director, or his designee, on final design drawings.
- D. Construction of utilities and paving in projects not requiring a subdivision plat is not permitted until final design drawings are approved and signed by the Director, Department of Public Works and Engineering, or his designee.
- E. Signature of the Director, Department of Public Works and Engineering, or his designee, on final design drawings for utilities which are intended to remain private, does not infer

acceptance of the City for ownership or maintenance or operation of facilities indicated on the drawings.

1.05 SUBMITTALS

A. Submittal Procedures

For Privately-funded Projects:

1. To obtain review of final design drawings for both publicly-funded and privately-funded projects, first submit drawings to the Public Works and Engineering Plan Review Center for assignment of a log number before review will commence. The log number will remain in effect for one year.
2. Once a log number is assigned, reference the number in all correspondence relating to that project.
3. Obtain and complete plan review application forms for each review phase when the project is logged in. The same log number will be used for all review phases of each project unless review of a subsequent phase is delayed by over one year.
4. Plan Review Center personnel will process reviews through appropriate review teams in the Department of Public Works and Engineering.
5. If a project has begun the review process but becomes inactive for a period of 12 months from the date of the last correspondence, the project will be considered stopped, and the log number inactivated.
6. The City has a weekly one-day walk-through procedure for the signature stage of small projects. Instruction sheets for this procedure may be obtained in the Plan Review Center.
7. Projects involving construction of privately owned facilities require review and approval of any connection to a public water line, sanitary sewer, or storm sewer or to a public street, using the process defined in this manual.

For Design Contracts with the City: Submit documents in accordance with requirements of the professional engineering services contract.

B. Preliminary Design

1. Privately-funded Projects: Submit one set of the preliminary overall design concept with supporting evidence as described in Paragraph 1.07 and Paragraph 1.08.

2. Design Contracts with the City: Submit documents in accordance with requirements of the professional engineering services contract.

C. Final Design.

1. Privately-funded Projects:

- a. Submit sets of the final design drawings with prints containing preliminary review comments.
- b. For complex projects, it is recommended that a copy of the City review comments on the preliminary drawings be returned with the revised final design drawings.

2. Design Contracts with the City:

- a. Submit documents in accordance with requirements of the professional engineering services contract.
- b. Submit a copy of the City review comments on the preliminary drawings.

D. Signature Stage.

1. Submit original tracings with prints containing previous review comments.
2. Specification submittals:
 - a. Submit final design specifications for review on all City funded projects.
 - b. Provide notes on plans for all privately funded projects stating that all facilities shall be constructed in accordance with City of Houston Standards.
3. On City projects, submit final computer-generated drawing files in acceptable electronic media including vicinity maps, right-of-way drawings, construction drawings, or other information pertinent to the project. Submit surveyor's field book and electronic data in accordance with Chapter 2, Survey Requirements.
4. On privately funded projects, submit final computer generated drawing files in acceptable electronic media including plat, right-of-way maps, and construction drawings. Scanned images may be acceptable if project is less than 3 sheets.

1.06 QUALITY ASSURANCE

- A. Have surveying and platting accomplished under direction of a Professional Land Surveyor.

- B. Have recording documents sealed, signed, and dated by a Professional Land Surveyor.
- C. Have calculations prepared by or under the direct supervision of a Professional Engineer trained and licensed in disciplines required by the project scope.
- D. Have final design drawings sealed, signed, and dated by the Professional Engineer responsible for development of the drawings.

1.07 RESEARCH REQUIREMENTS

- A. Research existing utility and right-of-way information with the City departments listed below. Present and discuss the concept of the project with these same departments.
 - 1. Houston Airport System
 - 2. Department of Public Works and Engineering
 - a. Engineering and Construction Division
 - b. Planning and Development Services Division File Room
 - c. Right-of-Way and Fleet Maintenance Division and Traffic & Transportation Division
 - d. Planning and Development Services Division, Utility Planning and Analysis Branch
 - e. Public Utility Division
 - 3. Planning and Development Department
 - 4. Parks and Recreation Department
 - 5. Finance Department, Franchise Administration
- B. Research existing utilities and rights-of-way or easements for conflicts with the following public and private organizations:
 - 1. Texas Department of Transportation
 - 2. Harris County Public Infrastructure Department
 - 3. Harris County Toll Road Authority
 - 4. Other County Governments

5. Franchise Holders:
 - a. CenterPoint Energy - Entex
 - b. AT & T Bell Company
 - c. CenterPoint Energy
 6. Cable television and data communications companies
 7. Other utility companies:
 - a. Utility districts
 - b. Private utilities/franchises
 - c. Railroad companies
 - d. Pipeline companies
- C. Verify that no restrictions or conflicts exist that will prevent approval and permitting of the project.

1.08 DESIGN REQUIREMENTS

A. Preliminary Design.

1. Privately-funded Projects:
 - a. Prior to preliminary design submittal, City reviewers are available to discuss alternate solutions for project elements where alternate designs may be considered.
 - b. Provide the Office of City Engineer with drawings in sufficient detail to describe the proposed improvements. Include proposed materials, if different from materials approved by the City. Identify any problems or conflicts associated with the project. Information furnished must be in sufficient detail for the City Engineer to assess whether the design meets current City design standards.
 - c. Provide rights-of-way and easement requirements for the project.
2. Design Contracts with the City:

- a. Participate in preliminary conferences with the City Project Manager outlining the scope of work and extent of the preliminary report.
- b. Prepare preliminary engineering studies and designs based upon the scope of work and as outlined in the professional engineering services contract with the City.
- c. Prepare the contractually specified number of copies of preliminary layouts, sketches, reports, and calculations supporting the preliminary layouts. Prepare alternate solutions, where applicable to the project, and include the engineer's specific recommendations.
- d. Prepare preliminary cost estimates for primary and alternate solutions of the proposed construction.
- e. Participate in conferences with the City to determine final design.
- f. When required by the professional services contract, provide detailed soils and geotechnical investigations and environmental investigations to support proposed construction of utilities and paving.
- g. Provide required real estate, rights-of-way, and easement requirements for the project.

B. Final Design

1. Privately-funded Projects:
 - a. Revise design to reflect comments of the City Engineer and review authorities. Include design calculations to support proposed improvements.
 - b. Provide review prints to the City Engineer and review authorities for verification and compliance with prior review comments.
 - c. Obtain required signatures from governmental agencies (other than the City of Houston) and private utility companies prior to requesting signature by the City.
 - d. Include the following note on construction drawings - "Contractor shall notify the City of Houston, Department of Public Works and Engineering (713-837-7000) 48 hours before starting work on this project."
2. Design Contracts with the City:

- a. Furnish the City, where applicable, engineering data necessary for applications for routine permits required by local, state, and federal authorities.
- b. Prepare detailed final design drawings and specifications in compliance with comments received from the City subsequent to the review of the preliminary design.
- c. Prepare detailed cost estimates and proposal forms for the authorized project.

C. Original Drawings

1. Approved drawings for projects within the city limits and within the ETJ will be assigned a City drawing number and will be filed in the City File Room prior to release back to the engineer of record. File Room record files for facilities within public rights-of-way will be available to the public. Record files associated with plants, buildings and other facilities outside public rights-of-way will be restricted pending security constraints.

END OF CHAPTER

City of Houston

Design Manual

Chapter 2

SURVEY REQUIREMENTS

Chapter 2

SURVEY REQUIREMENTS

2.01 CHAPTER INCLUDES

- A. Suggested guidelines for use by engineers in development of construction drawings and right-of-way maps inside the Houston city limits and outside the Houston city limits within the ETJ. These guidelines are required for Capital Improvement Projects designed under professional services contracts with the City of Houston.

2.02 REFERENCES

- A. Article IV, Chapter 33, City Surveys, of the Code of Ordinances.
- B. Professional Land Surveying Practices Act, latest revision.

2.03 DEFINITIONS

- A. Survey Field Books - Bound standard engineer's field books for transit and level, 7-1/4 inch by 4-3/4 inch.
- B. Data Collection Base - A database printout file reflecting station occupied, backsight, point number, angle, distance, elevations, and identification code; or station and offset left and right from a centerline or control line (transit, baseline, traverse, survey, etc.).
- C. City Surveyor - An authorized representative of the City having approval authority for privately-funded projects or having authority for administration of contracts for the City.
- D. GPS – Global Positioning System operated by US Department of Defense. When it is used with proper observation procedures and equipment, it can provide survey quality locations in terrestrial space.
- E. Site Control Monuments - Monuments needed to augment existing City monuments, conforming to standards established by the City Surveyor.

2.04 DESIGN REQUIREMENTS

- A. Adhere to these guidelines for Capital Improvement Projects designed under professional services contracts with the City of Houston.

2.05 SUBMITTALS

- A. For work performed through a professional service contract with the City, deliver field books and an electronic file in standard ASCII format (Point Number, Northing, Easting, Elevation, Description) at completion of the design phase. Photocopies or carbon copies of field books are not acceptable. Field books and electronic files will be retained in the City's permanent files.
- B. For right-of-way drawings identifying or describing acquisition of new or additional rights-of-way, deliver field books and database printout files to the City Surveyor or a designee of the City Surveyor. Additional documents to be submitted are:
 - 1. Overall map of rights-of-way with individual drawings of parcels identified on overall maps. Map or drawing media shall be mylar.
 - 2. Computer printouts of coordinate computations.
 - 3. Abstract information, all recorded plats and copies of instruments used (i.e., deeds) in preparation of the right-of-way drawings.
- C. For projects requiring new Site Control Monuments, the surveyor responsible for setting the monuments shall submit sealed City of Houston monument sheets, with necessary supporting data, to the City Survey Office.

2.06 QUALITY ASSURANCE

- A. Field surveying used in the development of construction drawings, calculations and preparation of right-of-way maps, and field note descriptions shall be performed by or under the direct supervision of a Professional Surveyor.
- B. Field notes, metes and bounds descriptions and right-of-way maps shall have the imprinted or embossed seal of the responsible Professional Surveyor and shall be dated and signed by the Professional Surveyor.
- C. When establishing Horizontal Control, surveyors shall transcribe onto the pages of a standard Survey Field Book, as described in Paragraph 2.03.A, all angles and distances, at the time of measurement, with an accompanying sketch. When establishing Vertical Control, the surveyor shall use differential leveling, or GPS methods, and transcribe the vertical data onto the pages of a standard Survey Field Book, with an accompanying sketch.
- D. For projects in which the Horizontal Control exceeds a distance of 2,000 feet from a found City of Houston monument, a Site Control Monument shall be set. Additional Site Control Monuments shall be set should the Horizontal Control exceed a radial distance of 2,000 feet from an existing City of Houston monument or newly set Site Control Monument. Obtain City monument designation numbers from the City Survey Office. If an existing Site Control Monument is used to reference the project, said Site Control monument must be re-observed

and re-submitted with the resultant horizontal and vertical coordinates. All recovery ties must be re-observed and present on the new recovery sheets.

2.07 FIELD WORK

- A. For engineering contracts with the City, field work shall be recorded in field books or electronic field books. Obtain a field book number from the Survey Section and record this identification in the title block on drawing sheets.
- B. The control line must be monumented at its beginning, end, and at angle points with markers of a permanent nature, such as iron rods, spikes, or other lasting identification. Make reference drawings for each control monument showing ties to planimetric features to allow easy recovery. Set markers at a maximum of 1000 feet on long lines. (Wherever practical, all Horizontal and Vertical Control monuments must be marked in such a way as to identify the surveyor in responsible charge.)
- C. Locate any found monuments and/or property corners and reference them to the design baseline according to the existing City of Houston survey system, as required by Article IV, Chapter 33, City Surveys, of the Code of Ordinances.
- D. Use the City datum (Code of Ordinances section 33, article 4) as a basis for all elevations. Set temporary bench marks (TBMs) within 200 feet of the beginning and end of each project baseline and at intervals not to exceed 1000 feet throughout the project.
- E. Show the stations of all side street construction centerlines with angular relationships or bearings of said centerlines of side streets with the main roadway centerline station.
- F. Record topographic features within the public right-of-way, proposed right-of-way, any contiguous easements to the right-of-way, and any construction right-of-way of the project and on intersecting streets for a distance of 20 feet beyond the intersection of the right-of-way lines. Identify all visible underground structures, such as inlets, manholes, and junction boxes, with size, depth, and type.
- G. Cross sections shall be taken at intervals of 100 feet for projects outside of the CBD. For projects within the CBD, take cross sections at 25 or 50 foot intervals. For levels recorded in field books, record rod readings or elevations as numerator and distance right or left of the base or centerline as the denominator. Data collector of a total station can be used to acquire necessary elevations at required intervals. Record elevation of driveways at intersection of driveway centerline with existing or proposed right-of-way line. Cross sections shall include a reading at the following points: street centerline, flow-line of ditch or gutter, curb or pavement edge, sidewalk, the existing or proposed right-of-way line, 20 feet beyond the right of way line if possible, and on intersecting streets for a distance of 100 feet beyond proposed pavement. See Figure 2.1 Perimeter of Standard Topographical Survey.
- H. For acquisition of new or additional rights-of-way:

1. Tie points of commencing (POCs) or points of beginning (POBs) for each parcel to the NSRS datum (CORS monuments).
2. Set iron rods or permanent markers at the intersections of the proposed right-of-way and property lines of parcels to be acquired.
3. Identify monuments, corners, angle points, points of curve (PCs), points of intersection (PIs), points of tangency (PTs), and other points as either "found" or "set." Describe each monument in such a way as to clearly define size, type of material and the nature of the monument, i.e., 3/4-inch iron pipe, 5/8-inch iron rod, cotton spindle, mag nail, etc.
4. Locate visible improvements, buildings, fences, permanent signs, utilities and other structures within 10 feet of the proposed right-of-way line.

2.08 CALCULATIONS

- A. Calculate coordinates of proposed right-of-way parcels, control points, found or set monuments, curve data, lengths, stations and offsets to monuments, and proposed improvement features.
- B. Computer printouts of the coordinate calculations should be submitted to the City with field books and database printout files.

2.09 CONSTRUCTION DRAWINGS

- A. Found monuments must be plainly shown on the drawings and located by station and distance, right or left from the control line, or construction centerline. Monuments used to establish the control line must be identified as Control Points, and their relationship to the construction centerline and to the proposed right-of-way lines must be shown. If the project is dimensioned from a control line, such as construction or design baseline, which is different than the control line referenced in Paragraph 2.07, it must be established and monumented in accordance with the requirements of Paragraph 2.07. Coordinates for transverse control points and all points of curve, points of tangency, and points of intersection along the design baseline shall be shown.
- B. Show location and identification of existing City survey monuments and found monument, by station and distance and whether right or left of control line or centerline. Show swing ties set for control or centerline control points using the City of Houston Recovery sheet format.
- C. Show and identify location of the City datum monuments and temporary bench marks used for elevation control. List the TBM located closest to that particular sheet in a station/offset, description and elevation format.

- D. Show centerline angles of intersection of side streets with main roadway centerline. Where bearings are used, identify source of bearings and show bearings on both control line and project centerline when they are not the same line.
- E. Identify locations of manholes, angle points, bends, etc., for proposed wastewater, storm sewers, water lines, and pavement features such as radius returns and centerlines of boulevard openings. Show relationship of proposed improvements to the right-of-way line.
- F. For bridges, overpasses and underpasses show top of pavement elevations at gutter line and centerline for the following locations:
 - 1. Construction joints
 - 2. Armor or expansion joints
 - 3. Intervals between bents that correspond to the increments used for dead load deflection calculations.
- G. For bridges and grade separations, drawings must incorporate layout sheets which identify proposed centerline and curve information plus:
 - 1. Surface coordinates for control points so that an inverse between coordinates reflects a surface distance. Identify origin of coordinate system used.
 - 2. Show coordinates of centerline or control line at PIs.
 - 3. Show coordinates of curb lines at their intersection with the centerline of bents and abutments for irregular structures.
- H. For all horizontal and vertical control monuments, show published coordinates expressed in units of U.S. Survey Feet and as a part of the Texas Coordinate System of 1983. Proper metadata for GPS – derived points should include the vertical adjustment, the Geoid used, the ITRF used and the current published coordinates of the base stations at the time of calculation.

2.10 RIGHT-OF-WAY MAPS

- A. Show "x," "y" values on monuments based on the City survey control and the scale factor used to convert grid coordinates to “surface” coordinates. All Distances shall be shown as “surface” distances and plainly marked as such. All bearings shall be based on the Texas Coordinate System of 1983.
- B. Distances on proposed right-of-way lines shall be continuous from beginning to end of the job. Show either straight line or arc distance across intersecting streets.

- C. Where a parcel is taken from a larger tract, show dimensions, distances, and area of the remainder of the tract based on recorded information.
- D. Identify the evidence used to decide the final placement or establishment of the proposed right-of-way line, such as angle points, or corner monuments, as either "set" or "found." The description of each point used shall be shown on the drawing as identified in the field survey.
- E. Grid Coordinate values of "x," "y" shall be shown for PCs, PTs, and PIs of curves on the proposed right-of-way lines. Curve data must include the following: delta, radius, arc length, chord length, and chord bearing.
- F. Grid Coordinate values of "x," "y" must be given on the POB of at least one tract in each block. Where the proposed right-of-way is to be acquired from a large tract of land, coordinate values should be given for the POB of field note description of the large tract.
- G. Other information to be shown on right-of-way maps:
 - 1. All visible improvements such as buildings, fences, permanent signs, utilities, and other structures located on the property or within 10 feet outside the right-of-way line, if accessible.
 - 2. Abstract information used in preparation of the right-of-way map.
 - 3. Field book numbers obtained from the City Surveyor.
 - 4. Real estate numbers obtained from the City Surveyor, right-of-way engineer, or Real Estate Division.

2.11 DOCUMENTS

- A. Where new construction will damage, destroy, or alter existing survey markers, include in specifications a requirement for installation of survey marker boxes by construction contractor at a unit price per box. The City Surveyor will determine the number and location of boxes to be furnished and installed by the contractor.
- B. Plats, metes and bounds description and field books shall have the Professional Surveyor's seal, signature and date affixed to the instrument.

END OF CHAPTER

FIGURE 2.1
PERIMETER OF STANDARD
TOPOGRAPHICAL SURVEY

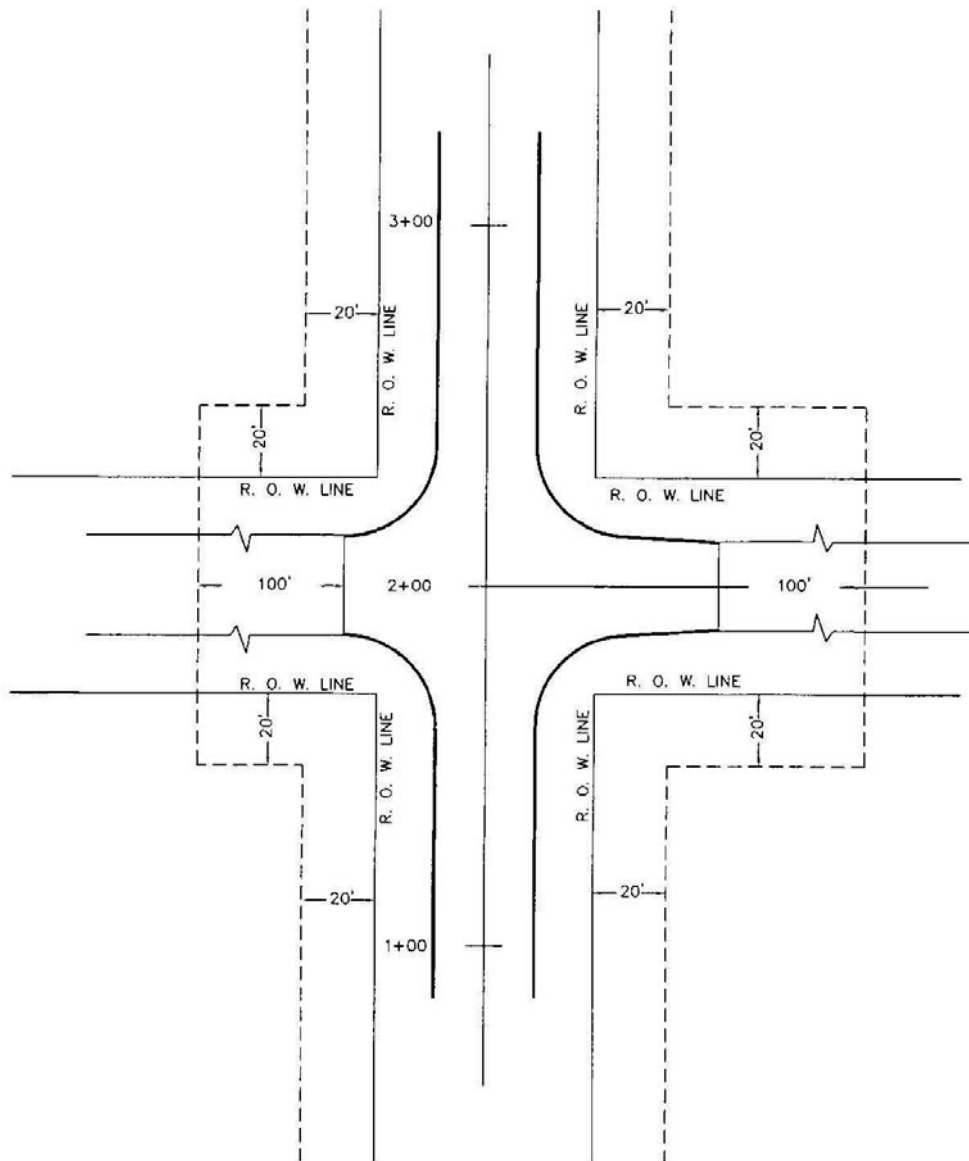

City of Houston

Design Manual

Chapter 3

GRAPHIC REQUIREMENTS

Chapter 3

GRAPHIC REQUIREMENTS

3.01 CHAPTER INCLUDES

- A. Graphic requirements for engineering drawings.

3.02 REFERENCES

- A. City of Houston monument ties in compliance with Article IV, Chapter 33, City Surveys, of the Code of Ordinances.

3.03 DEFINITIONS

- A. Computer Aided Drafting Design (CADD) - Preparation of drawings, plans, prints, and other related documents through the use of computer equipment and software programs.

3.04 DESIGN REQUIREMENTS

- A. Provide a cover sheet for projects involving three or more design drawings (excluding standard City of Houston detail sheets). Drawing sheet numbers and titles shall be listed on the cover sheet. Include an area key map and vicinity map to identify project location.
- B. Drawings shall be prepared on 23" x 36" Federal Aid Sheets, 22" x 34" ANSI standard drawing sheets, or nominal 24" x 36" drawing sheets, as appropriate.
- C. Show service area on cover sheet or area map.
- D. Final design drawings shall be India ink on mylar, or produced by CADD on mylar using non-water based ink. Do not use adhesive-backed material on final drawings. Stick-ons may be allowed with approval of the City Engineer for a minor correction during the final review process.
- E. Details of special structures (not covered by approved standard drawings, such as stream or gully crossings, special manholes, or junction boxes) shall be drawn with vertical and horizontal scales equal to each other.
- F. Each set of engineering drawings shall contain paving and utility key drawings indexing specific plan and profile sheets. City Standard Details, where applicable, shall be included. All sheets shall have standard title blocks. Where applicable, show HCFCD key drawings and numbers.
- G. Draw key overall layouts to a minimum scale of 1" = 200'.

- H. Plan stationing must run from left to right, except for short streets or lines originating from a major intersection, where the full length can be shown on one sheet.
- I. A north arrow is required on all sheets and should be oriented either toward the top or to the right. This requirement is waived under the following conditions:
1. A storm water or sanitary sewer with flow from west to east or from south to north.
 2. A primary outfall drainage ditch with flow from west to east or from south to north.
 3. Stationing is intended to start from the cardinal points of the compass and proceed in the direction of construction.
- J. Standard scales permitted for plans and profiles of paving and utility construction drawings are as follows:
1. Major thoroughfares, streets with esplanades over 400 feet in length, or special intersections/situations.

1" = 20' Horizontal, 1" = 2' Vertical
 2. Minor or residential single-family streets.

1" = 20' Horizontal, 1" = 2' Vertical
1" = 50' Horizontal, 1" = 5' Vertical, or
1" = 40' Horizontal, 1" = 4' Vertical
 3. Scales of Paragraph 3.04J.2 above are minimum; larger scales may be used to show details of construction.
 4. Deviation from specified scales can only be permitted with the special approval of the City Engineer, project manager on Design Contracts with the City.
 5. Single-banked plan-and-profile drawings are acceptable; double-banked plan-and-profile sheets are allowed in certain situations such as off-site utility lines in undeveloped areas.
- K. Show ties on drawings to City monuments when applicable; otherwise, make a statement on the cover sheet referencing assumed control coordinates.
- L. Each sheet of the plan and profile shall have a benchmark elevation and description defined.
- M. The seal, date, and original signature of the Professional Engineer responsible for the drawings is required on each sheet developed by the design engineer. The design engineer

- may use stamped seal or embossed imprint; however, the embossed imprint must be shaded so that it will reproduce on prints.
- N. A copy of the final plat for new development shall be included with the final design drawings when submitted for final approval.
- O. If a roadway exists where drawings are being prepared to improve or construct new pavement or a utility, label the existing roadway width, surfacing type, and thickness.
- P. Show all street and road alignments on drawings.
- Q. Develop drawings to accurate scale showing proposed pavement, typical cross sections, details, lines and grades, and existing topography within street right-of-way, and any easement contiguous with the right-of-way. At the intersection, the cross street details shall be shown at sufficient distance (20-foot minimum distance outside the primary roadway right-of-way) in each direction along cross street for designing adequate street crossings.
- R. Match lines between plan and profile sheets shall not be placed or shown within cross street intersections including cross street right-of-way.
- S. Show natural ground profiles as follows:
1. For privately-funded projects, centerline profiles are satisfactory except where a difference of 0.50 feet or more exists from one right-of-way or easement line to the other, in which case, dual profiles are required.
 2. For City projects, provide natural ground profiles for each right-of-way line. Easement profiles shall conform to Paragraph 3.04T.1.
- T. Basic plan and profile sheets shall contain the following information:
1. Identify lot lines, property lines, easements, rights-of-way, and HCFCD outfalls.
 2. Label each plan sheet as to street/easement widths, pavement widths, pavement thickness where applicable, type of roadway materials, curbs, intersection radii, curve data, stationing, existing utilities (type and location), and any other pertinent feature affecting design.
 3. Show utility lines 4 inches in diameter or larger within the right-of-way or construction easement in profile view. Show utility lines, regardless of size, in the plan view, including communication and fiber optic cables.
 4. Graphically show flow line elevations and direction of flow for existing ditches.

5. Label proposed top of curb grades except at railroad crossings. Centerline grades are acceptable only for paving without curb and gutters.
 6. Show in profile curb return elevations for turnouts.
 7. Gutter elevations are required for vertical curves, where a railroad track is crossed.
 8. For street reconstruction projects, show in profile the centerline elevation at the property line of existing driveways.
 9. Show both existing and proposed station esplanade noses or the centerline of esplanade openings, including esplanade width.
 10. The design of both roadways is required on paving sections with an esplanade.
 11. Show in plan view station PCs, PTs, and radius returns. Show in profile station radius returns and grade change PIs with their respective elevations.
- U. For plant work, use a grid system to locate proposed work.

3.05 GRAPHIC STANDARDS

- A. The following graphic standards for plan and profile shall apply to drawings of 1" = 20' scale. For smaller scale drawings, use proportionally smaller line sizes.
- B. Existing Improvements: The standards shown in Figure 3.1, Existing Improvements, are required for depicting existing improvements on base drawings. Use lower case letters with a No. 0 reprographic pen or equal line weight unless otherwise shown in the pen/line weight table, Figure 3.3, Line Code Definitions. Smaller pen sizes for lettering may be used for clarity.
- C. Proposed Improvements: The standards shown in Figure 3.2, Proposed Improvements, are required for depicting proposed improvements on base drawings. Use upper case letters with a No. 3 reprographic pen or equal line weight unless shown otherwise in the pen/line weight table, Figure 3.3, Line Code Definitions. Smaller pen sizes for lettering may be used for clarity.
- D. Signature Block: Use latest edition of Signature Blocks issued by the Engineering and Construction Division for private and City projects.

END OF CHAPTER

FIGURE 3.1
 EXISTING IMPROVEMENTS
 PLAN VIEW
 TEXT FOR EXISTING IMPROVEMENTS SHALL NOT BE SMALLER THAN 60 LEROY

		WT	LC
ROW LINE		3	0
PROPERTY LINE		3	0
THEORETICAL PROPERTY LINE		3	0
LOT LINES		1	0
EASEMENT LINE		0	2
CENTER LINE OF ROW		0	4
TRANSIT LINE		0	0
EDGE OF DITCHES		0	0
CENTER LINE OF DITCHES		0	2
EDGE OF DITCHES		0	0
FENCE LINE, WOOD		0	0
FENCE LINE, CHAIN LINK		0	0
FENCE LINE, BARBED WIRE		0	0
FENCE LINE, HOG WIRE		0	0
EDGE OF CONCRETE		0	0
CURB LINE		0	0
EDGE OF ASPHALT		0	0
EDGE OF SHELL OR GRAVEL		0	2
DIMENSION LINE		0	0
CENTERPOINT ENERGY AERIAL LINE		0	0
CENTERPOINT ENERGY UNDERGROUND LINE		0	6
GAS LINE		0	1
MISC UNDERGROUND LINES		0	8

WT	K & E PEN NO	LINE WEIGHT/WIDTH	METRIC
0	0	0.014"	0.35mm
1	1	0.020"	0.50mm
2	2	0.024"	0.60mm
3	3	0.031"	0.80mm
6	6	0.055"	1.40mm

LEGEND:
 WT LINE WEIGHT
 LC LINE CODE

FIGURE 3.1 (CONTINUED)
 EXISTING IMPROVEMENTS
 PLAN VIEW
 TEXT FOR EXISTING IMPROVEMENTS SHALL NOT BE SMALLER THAN 60 LEROY

		WT	LC
PIPELINE OR WESTERN UNION CONDUIT	(IDENTIFY CONDUIT)	0	1
AT & T CONDUIT		0	2
CABLE TV		0	2
MATCH LINE		3	0
RAILROAD LINE		0	0
WATER LINE	20" (AND SMALLER) WATER	0	7
	24" (AND LARGER) WATER		
WASTEWATER SEWER LINE	24" (AND SMALLER) WASTEWATER SEWER	0	3
	30" (AND LARGER) WASTEWATER SEWER		
STORM SEWER LINE	24" (AND SMALLER) STORM SEWER	0	0
	30" (AND LARGER) STORM SEWER		
IRON PIPE OR IRON ROD MONUMENTS	3/4" IP	0	0
POINT OF INTERSECTION (PI)		0	0
POINT OF CURVE (PC) POINT OF TANGENCY (PT)		0	0
POWER POLE		0	0
POWER POLE W/DOWN GUY		0	0
GAS METER	GM	0	0
GAS VALVE	GV	0	0
MISC UNDERGROUND PIPELINE LABEL	A2	0	0

WT	K & E PEN NO	LINE WEIGHT/WIDTH	METRIC
0	0	0.014"	0.35mm
1	1	0.020"	0.50mm
2	2	0.024"	0.60mm
3	3	0.031"	0.80mm
6	6	0.055"	1.40mm

LEGEND:
 WT LINE WEIGHT
 LC LINE CODE

FIGURE 3.1 (CONTINUED)
 EXISTING IMPROVEMENTS
 PLAN VIEW

TEXT FOR EXISTING IMPROVEMENTS SHALL NOT BE SMALLER THAN 60 LEROY

		WT	LC
PAVING HEADER		0	0
BUILDING, RESIDENTIAL		0	0
BUILDING COMMERCIAL		0	0
TREE		0	0
HEDGE		0	0
WATER METER		0	7
WATER VALVE (GATE)		0	7
WATER VALVE (BUTTERFLY)		0	7
FIRE HYDRANT/FLUSHING VALVE		0	7
TAPPING SLEEVE & VALVE		0	7
REDUCER		0	7
ROUND CONNECTION		0	7
WASTE WATER SEWER CLEANOUT AND MANHOLE		0	0
STORM SEWER MANHOLE		0	0
STORM SEWER INLETS		0	0
CULVERT PIPE AND HEADWALL		0	2
TOP OF CURB OR GUTTER LINE ELEV.		0	2
CONTOUR LINE		0	0

WT	K & E PEN NO	LINE WEIGHT/WIDTH	METRIC
0	0	0.014"	0.35mm
1	1	0.020"	0.50mm
2	2	0.024"	0.60mm
3	3	0.031"	0.80mm
6	6	0.055"	1.40mm

LEGEND:
 WT LINE WEIGHT
 LC LINE CODE

FIGURE 3.1 (CONTINUED)
 EXISTING IMPROVEMENTS
 PROFILE VIEW

TEXT FOR EXISTING IMPROVEMENTS SHALL NOT BE SMALLER THAN 60 LEROY

		WT	LC
NORTH OR EAST PROPERTY LINE	-----	1	5
SOUTH OR WEST PROPERTY LINE	-----	1	6
NORTH OR EAST CURB	-----	1	7
SOUTH OR WEST CURB	-----	1	3
NORTH OR EAST DITCH	-----	1	7
SOUTH OR WEST DITCH	-----	1	3
NORTH OR EAST CULVERT	----- CULVERT	1	2
SOUTH OR WEST CULVERT	----- CULVERT	1	2
CENTERLINE OF ROW	-----	1	0
CENTERPOINT ENERGY CONDUIT	----- CENTERPOINT ENERGY CONDUIT	1	6
	----- CENTERPOINT ENERGY CONDUIT	1	0
GAS LINE	----- GAS LINE	1	1
	----- GAS LINE	1	0
WESTERN UNION	----- WESTERN UNION	1	1
	----- WESTERN UNION	1	0
AT & T CONDUIT	----- AT & T CONDUIT	1	2
	----- AT & T CONDUIT	1	0
WATER LINE	----- WATER LINE 20" (AND SMALLER)	1	7
	----- WATER LINE 24" (AND LARGER)	1	0
	----- SANITARY SEWER 24" (AND SMALLER)	1	3
WASTEWATER SEWER LINE	----- SANITARY SEWER 30" (AND LARGER)	1	0
	----- SANITARY SEWER 30" (AND LARGER)	1	0
STORM SEWER LINE	----- STORM SEWER 24" (AND SMALLER)	1	0
	----- STORM SEWER 24" (AND SMALLER)	1	0
	----- STORM SEWER 30" (AND LARGER)	1	0

WT	K & E PEN NO	LINE WEIGHT/WIDTH	METRIC
0	0	0.014"	0.35mm
1	1	0.020"	0.50mm
2	2	0.024"	0.60mm
3	3	0.031"	0.80mm
6	6	0.055"	1.40mm

LEGEND:

WT LINE WEIGHT
 LC LINE CODE

FIGURE 3.1 (CONTINUED)
 EXISTING IMPROVEMENTS
 PROFILE VIEW

TEXT FOR EXISTING IMPROVEMENTS SHALL NOT BE SMALLER THAN 60 LEROY

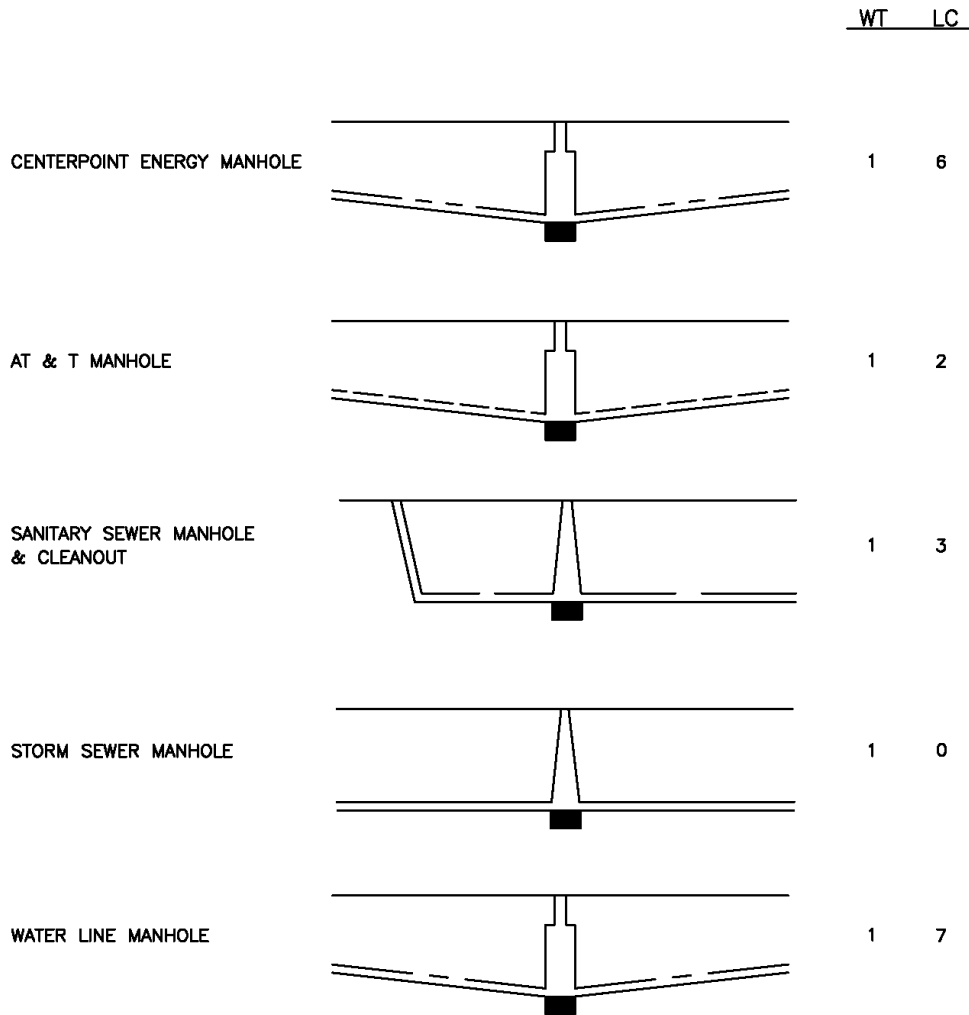

WT	K & E PEN NO	LINE WEIGHT/WIDTH	METRIC
0	0	0.014"	0.35mm
1	1	0.020"	0.50mm
2	2	0.024"	0.60mm
3	3	0.031"	0.80mm
6	6	0.055"	1.40mm

LEGEND:
 WT LINE WEIGHT
 LC LINE CODE

FIGURE 3.2
 PROPOSED IMPROVEMENTS – WATER LINES
 PLAN VIEW
 TEXT FOR PROPOSED IMPROVEMENTS SHALL NOT BE SMALLER THAN 100 LEROY

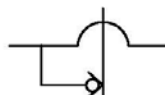
		<u>WT</u>	<u>LC</u>
WATER LINE	20" (AND SMALLER)	3	7
	24" (AND LARGER)	3	7
WATER VALVE (GATE)	WV	3	7
WATER VALVE (BUTTERFLY)	BFWV	3	7
TAPPING SLEEVE & VALVE	TS&V	3	7
FIRE HYDRANT/FLUSHING VALVE	FHY/FV	3	7
	WV	3	7
REDUCER	12" → 8"	3	7
ROUND CONNECTION		3	7



PROPOSED IMPROVEMENTS – WATER LINES
 PROFILE VIEW
 TEXT FOR PROPOSED IMPROVEMENTS SHALL NOT BE SMALLER THAN 100 LEROY

		<u>WT</u>	<u>LC</u>
WATER LINE	WATER LINE 20" (AND SMALLER)	3	7
	WATER LINE 24" (AND LARGER)	3	0
	WATER LINE 24" (AND LARGER)	3	7
	WATER LINE 24" (AND LARGER)	3	0

WT	K & E PEN NO	LINE WEIGHT/WIDTH	METRIC
0	0	0.014"	0.35mm
1	1	0.020"	0.50mm
2	2	0.024"	0.60mm
3	3	0.031"	0.80mm
6	6	0.055"	1.40mm

LEGEND:
 WT LINE WEIGHT
 LC LINE CODE

FIGURE 3.2 (CONTINUED)
 PROPOSED IMPROVEMENTS – SANITARY SEWER LINES
 PLAN VIEW
 TEXT FOR PROPOSED IMPROVEMENTS SHALL NOT BE SMALLER THAN 100 LEROY

		<u>WT</u>	<u>LC</u>
	24" (AND SMALLER)		
SANITARY SEWER LINE		3	3
	30" (AND LARGER)		
		3	3
MANHOLE		3	3

PROPOSED IMPROVEMENTS – SANITARY SEWER LINES
 PROFILE VIEW
 TEXT FOR PROPOSED IMPROVEMENTS SHALL NOT BE SMALLER THAN 100 LEROY

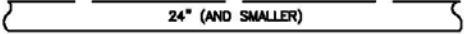
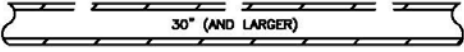
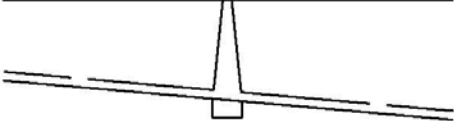
		<u>WT</u>	<u>LC</u>
	24" (AND SMALLER)		
SANITARY SEWER LINE		3	3
	30" (AND LARGER)		
		3	3
		3	0
MANHOLE		3	3
		3	0

WT	K & E PEN NO	LINE WEIGHT/WIDTH	METRIC
0	0	0.014"	0.35mm
1	1	0.020"	0.50mm
2	2	0.024"	0.60mm
3	3	0.031"	0.80mm
6	6	0.055"	1.40mm

LEGEND:
 WT LINE WEIGHT
 LC LINE CODE

FIGURE 3.2 (CONTINUED)
 PROPOSED IMPROVEMENTS – STORM SEWER LINES
 PLAN VIEW
 TEXT FOR PROPOSED IMPROVEMENTS SHALL NOT BE SMALLER THAN 100 LEROY

		<u>WT</u>	<u>LC</u>
STORM SEWER LINES	24" (AND SMALLER)	3	0
	30" (AND LARGER)	3	0
MANHOLE		3	0
INLETS		3	0

PROPOSED IMPROVEMENTS – STORM SEWER LINES
 PROFILE VIEW
 TEXT FOR PROPOSED IMPROVEMENTS SHALL NOT BE SMALLER THAN 100 LEROY

		<u>WT</u>	<u>LC</u>
STORM SEWER LINES	24" (AND SMALLER)	3	0
	30" (AND LARGER)	3	0
MANHOLE		3	0
INLETS		3	0

WT	K & E PEN NO	LINE WEIGHT/WIDTH	METRIC
0	0	0.014"	0.35mm
1	1	0.020"	0.50mm
2	2	0.024"	0.60mm
3	3	0.031"	0.80mm
6	6	0.055"	1.40mm

LEGEND:
 WT LINE WEIGHT
 LC LINE CODE

FIGURE 3.2 (CONTINUED)
 PROPOSED IMPROVEMENTS – PAVEMENTS
 PLAN VIEW
 TEXT FOR PROPOSED IMPROVEMENTS SHALL NOT BE SMALLER THAN 100 LEROY

		<u>WT</u>	<u>LC</u>
FACE OF CURB		6	3
EDGE OF PAVEMENT		6	0
CONCRETE WALK		3 2 3	3 0 3
CONCRETE HEADER		3	3
TOP OF CURB OR GUTTER LINE ELEVATION	<div style="border: 1px solid black; padding: 2px; display: inline-block;">TC=76.56</div> <div style="border: 1px solid black; padding: 2px; display: inline-block;">G=76.06</div>	2	0

PROPOSED IMPROVEMENTS – PAVEMENTS
 PROFILE VIEW
 TEXT FOR PROPOSED IMPROVEMENTS SHALL NOT BE SMALLER THAN 100 LEROY

		<u>WT</u>	<u>LC</u>
TOP OF CURB OR CENTERLINE FOR OPEN DITCH PAVING	<p style="text-align: center;">TC OR CL @ +0.03% TC OR CL @ -0.03%</p>	2 3	3 0

WT	K & E PEN NO	LINE WEIGHT/WIDTH	METRIC
0	0	0.014"	0.35mm
1	1	0.020"	0.50mm
2	2	0.024"	0.60mm
3	3	0.031"	0.80mm
6	6	0.055"	1.40mm

LEGEND:
 WT LINE WEIGHT
 LC LINE CODE

FIGURE 3.3
LINE CODE DEFINITIONS
ALL LENGTHS IN INCHES

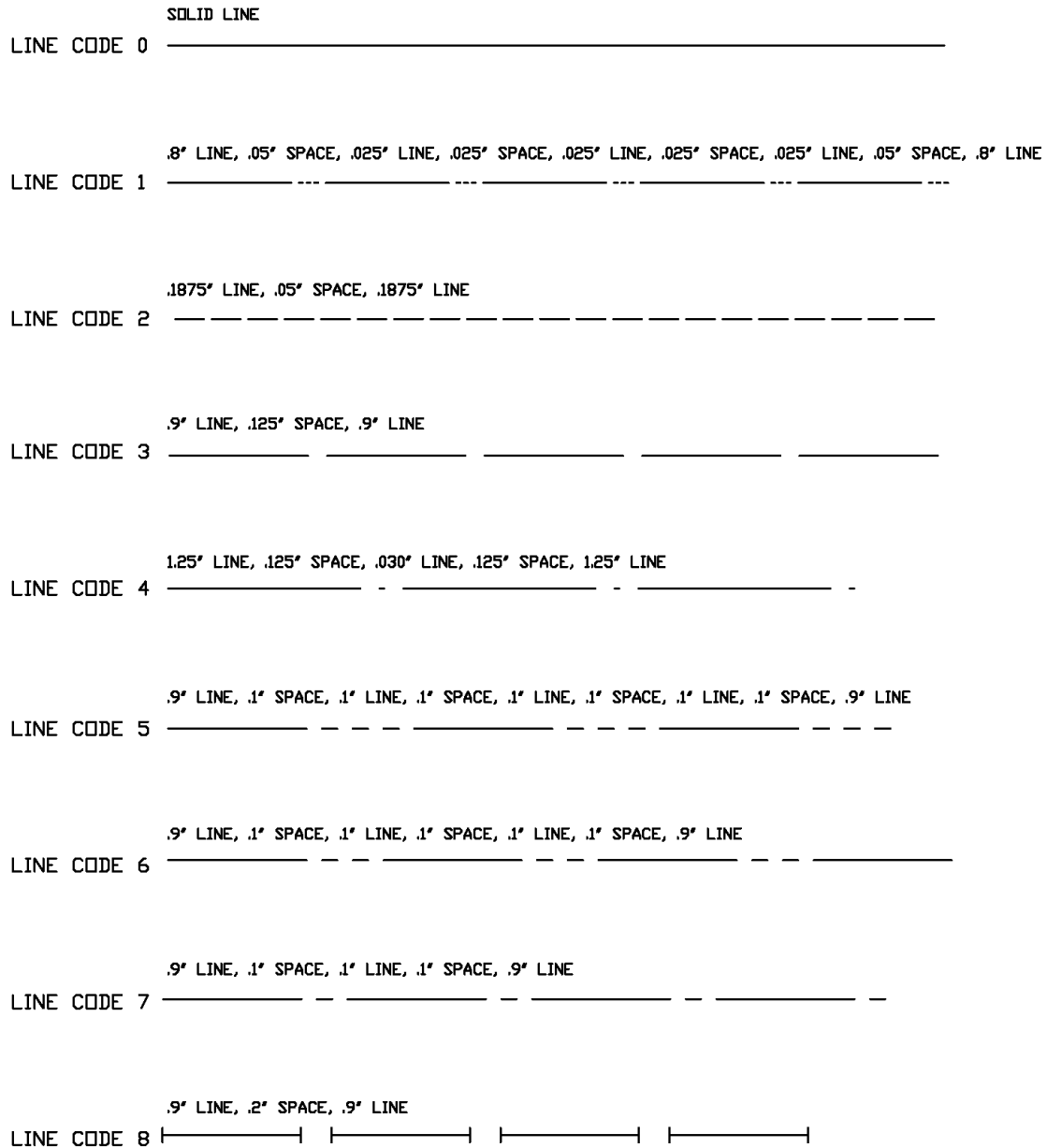

City of Houston

Design Manual

Chapter 4

PLATTING REQUIREMENTS

Chapter 4

PLATTING REQUIREMENTS

4.01 CHAPTER INCLUDES

- A. Coordination of platting requirements with the preparation of project drawings and specifications and their review and approval processing.

4.02 GENERAL PLATTING REQUIREMENTS

- A. Refer to Figures 4.1 and 4.2 for flow charts of the process by which plats and related documents are submitted, reviewed, and approved by the Department of Public Works and Engineering. There are three classes of subdivision plat: a class I plat, a class II plat and a class III plat. Class I plats and class II plats are optional and may be used in lieu of a class III plat if the subdivision plat meets the qualifications of Sec. 42-23 b and c, Division I, Article II, Chapter 42, of the Code of Ordinances. Class I and class II plats do not propose the creation of any new streets; nor propose the dedication of any easements for public water, wastewater collection or storm sewer lines. A class I plat goes through a ten day administrative review process within the Planning and Development Department. During that review questions may arise regarding the delivery of utilities that may be directed to Public Works and Engineering staff.
- B. Platting requirements are found in Chapter 42 of the Code of Ordinances.
- C. All class II and class III plats submitted to the Planning and Development Department will be routed to the Department of Public Works and Engineering for review.
- D. Design drawings (when required) shall be submitted to the Department of Public Works and Engineering with the name of the proposed plat clearly identified on the cover sheet.
- E. The Planning and Development Department may record plats after the Department of Public Works and Engineering approves design drawings.

4.03 DESIGN REQUIREMENTS

- A. Class III Preliminary Plat
 - 1. The level of investigation to be performed for a class III preliminary plat is to identify major development impediments to water, wastewater collection and treatment, or storm drainage that are primarily the result of constraints external to the plat itself. Such constraints include, but are not limited to:

- a. Water Lines:
 - (1) Long dead-end water lines.
 - (2) Single feed water lines.
 - (3) Inadequate capacity or pressure to the site.
 - (4) Future plans for construction of major City facilities that will impact the site.
 - b. Wastewater Collection System:
 - (1) Inadequate right-of-way or wastewater easements.
 - (2) Limited wastewater service capacity for the area.
 - (3) Future plans for construction of major City facilities that will impact the site.
 - c. Storm Drainage System:
 - (1) Drainage outfall severely under capacity.
 - (2) Encroachment into flood-prone areas or floodway.
 - (3) Storm water detention or diversions of watershed drainage that impact the property.
 - (4) Future plans for construction of major City facilities that will impact the site.
2. Department of Public Works and Engineering will review class III preliminary plats and take one or more of the following actions:
- a. Pose no objection to the plat.
 - b. Request a meeting with the applicant to discuss design and construction requirements.
 - c. Request specific additional information, easements, or improvements to the plat or the land within the purview of the department.
 - d. Request one-line drawings be submitted prior to detailed engineering drawings and final plat submittal.
3. Approval of a preliminary plat by Department of Public Works and Engineering does not infer approval of proposed infrastructure. Review of infrastructure will take place upon submittal of one-line drawings, if required, which may occur after preliminary plat approval and must occur prior to final plat approval.
- B. Class II and Class III Final Plat
1. The Department of Public Works and Engineering will review class II and class III final plats and final design drawings, easement documents, and other data. Review will be for the following items, as a minimum:

- a. Compliance with standards contained in this Design Manual.
 - b. Adequacy of service availability for:
 - (1) Water
 - (2) Wastewater
 - (3) Storm sewer or storm water detention.
 - c. Other design standards of the Department of Public Works and Engineering.
- C. Comments resulting from reviews described in Paragraphs 4.03A and 4.03B will be reported to the Planning and Development Department for inclusion in CPC Form 101.

4.04 DESIGN ANALYSIS

- A. For plats of land located inside the city limits, review of final design drawings and other documents required by the Department of Public Works and Engineering for final plat approval will address the following:
- 1. Resolution of conflicts with existing and proposed utilities.
 - 2. Layout of water lines for maximum circulation of water. The pattern shall allow at least two sources of water to be constructed within the public right-of-way or permanent easement. Side lot easements shall meet the requirements of Chapter 5, Easement Requirements, and Chapter 7, Water Line Design Requirements.
 - 3. Adequate capacity in water and wastewater facilities to be utilized. The City may require a current letter of utility commitment prior to approval of a plat.
 - 4. Adequacy of drainage facilities.
 - 5. Sizing and identification/designation of easements within the plat and required easements outside the plat boundary.
 - 6. Recordation of required off-site easements or lift station sites, their depiction on the plat, and submittal to the City of record documents.
- B. For plats of land located outside the city limits, review of final design drawings and other documents required by the Department of Public Works and Engineering for final plat approval will address all items in Paragraph 4.04A plus the following:
- 1. When appropriate, a letter from the municipal utility district's president or board or from the property owner stating that all off-site easements that are not immediately obtainable (for example: those crossing fee strips, rail roads, or other areas under

eminent domain) are in progress and that it is the intention of the municipal utility district or property owner to complete the acquisition of such easements. The letter will be accompanied by a certified survey plat and legal description of such easements.

2. That separately platted tracts requiring service are or will be directly served by public utilities located in or abutting public rights-of-ways or permanent access easements with overlapping public utility easements.
3. That necessary contracts and documents for inside the city limit and outside the city limit are approved and signed.
4. For a plat that includes portions both inside and outside the city limits and where there will be an imminent need for utility services, a current letter of utility commitment may be required prior to approval.

END OF CHAPTER

FIGURE 4.1
 CLASS III PRELIMINARY PLAT

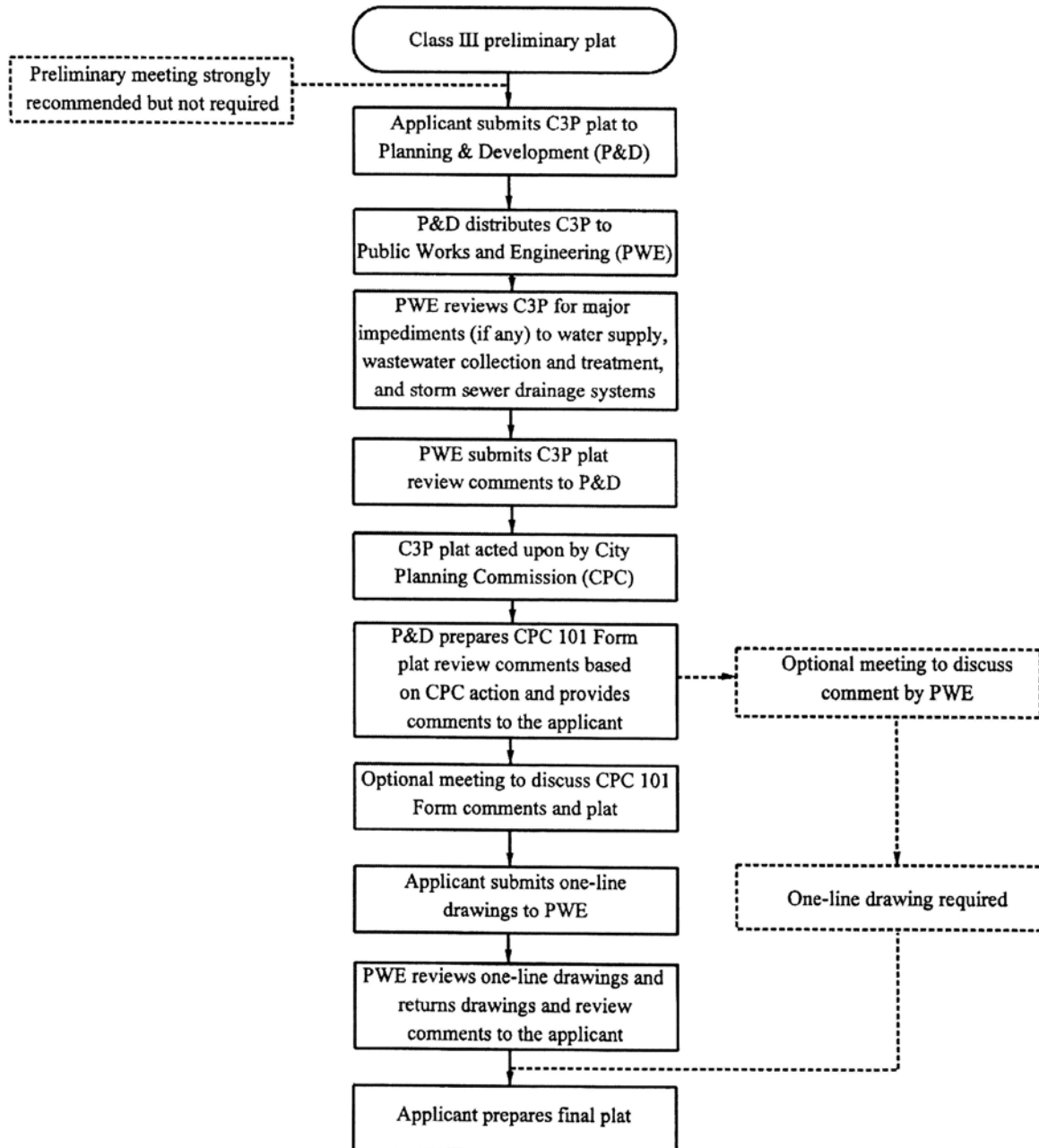
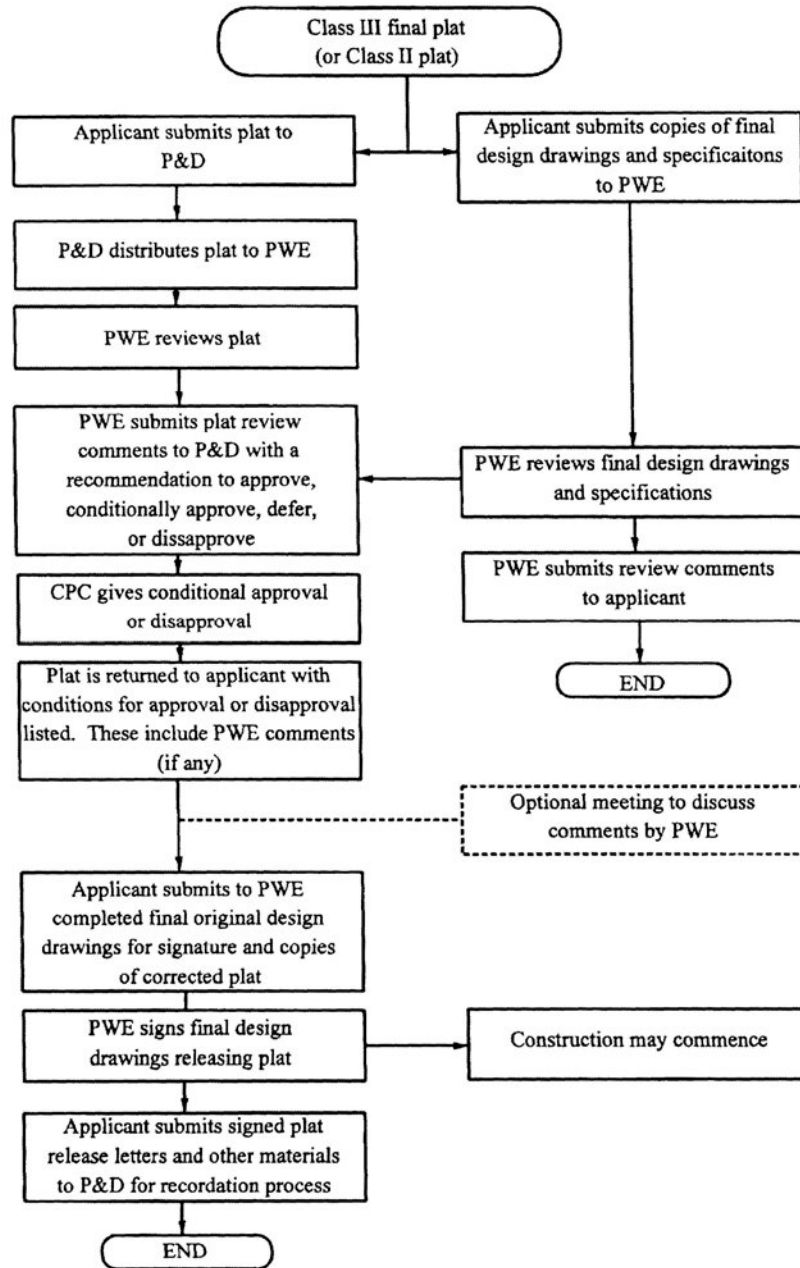

FIGURE 4.2
 CLASS III FINAL PLAT (OR CLASS II PLAT)



City of Houston

Design Manual

Chapter 5

EASEMENT REQUIREMENTS

Chapter 5

EASEMENT REQUIREMENTS

5.01 CHAPTER INCLUDES

- A. Requirements for allocating and recording easements for water, wastewater, and storm drainage facilities located outside of public rights-of-way.

5.02 REFERENCES

- A. Utility Coordination Committee (UCC) for the Metropolitan Area - Typical utility location in 10-foot- and 14-foot-wide easements, back-to-back lots, and perimeter lots.

5.03 DEFINITIONS

- A. Easements - Areas set aside for installation and maintenance of utilities by public and private utility operators.

5.04 DESIGN REQUIREMENTS

- A. Where public utilities are located in, along, across or adjacent to private drives, private streets or permanent access easements in platted single family residential lot subdivisions; such drives, streets or easements shall have an overlapping public utility easement to provide access and maintenance rights. Public utility easement rights shall be superior to permanent access easement rights allowing the City ingress and egress for maintenance of utilities.
- B. Easements for electrical and gas lines must comply with requirements of the UCC and are not covered under this Design Manual.
- C. Easements are to be defined and submitted as part of the recordable plat either shown on the plat or by metes and bounds description. The process for recording the plat is described in Chapter 4, Platting Requirements.

5.05 QUALITY ASSURANCE

- A. Recordable plats and metes-and-bounds descriptions of easements must be prepared under the direction of a Professional Surveyor. The surveyor must seal, sign, and date documents prepared under his supervision.

5.06 PLAT AND EASEMENT REQUIREMENTS

- A. Requirements for Platted Easements.

1. For construction inside city limits, submit a copy of the final plat accompanied by a CPC Form 101 together with the original engineering drawings for approval and signatures.
 2. For construction outside city limits but within Houston's ETJ.
 - a. Where no easements are required outside the plat boundary, follow the same requirements as for plats inside city limits given in Paragraph 5.06A.1.
 - b. Where easements are to be dedicated outside the plat boundary or through property under different ownership, follow the instructions in Paragraph 5.06A.1 for plats inside city limits and the additional requirements following:
 - (1) Submit a copy of the recorded instrument creating the easement or a metes-and-bounds description and a map of the easement, along with a letter from the Municipal Utility District Board or property owner stating the intent to obtain or dedicate necessary easements. The instrument shall be recorded prior to or simultaneously with the plat.
 - (2) All off-site easements necessary to serve a proposed development must be shown on the face of the plat, or an acceptable tie between the plat and easements must be established between the two documents. Off-site easements must be recorded prior to or simultaneously with recordation of the plat.
- B. Requirements for Easements Deeded to the Public or to the City. Easements required for construction of a proposed project must be approved and accepted prior to approval of final design drawings or issuance of a permit for the proposed construction.
- C. Additional Requirements for Easements Deeded to the City:
1. Easements shall be either a part of the dedication on the plat of a subdivision, deeded to the City on standard forms provided by the City for that purpose, or on forms approved by the City Attorney.
 2. The person seeking to deed an easement to the City shall furnish the City with a reproducible map showing the easement and its location.
 3. A construction permit will be granted upon acceptance by the City of recordable instruments dedicating the easements.

5.07 DESIGN REQUIREMENTS

A. Easements for Water Lines and Appurtenances.

1. Water Lines:

- a. When outside a public street right-of-way or permanent access easement with overlapping public utility easements, easements must be dedicated and restricted for water lines only.
- b. When possible, easements should be contiguous with public rights-of-way. For water line located not adjacent to public rights-of-way shall have a minimum water easement width equal to twice the water line diameter plus the depth of the water line from natural ground or final ground elevation, whichever is greater; but not less than 20 feet on water line across open country (acreage) or commercial reserve.
- c. Provide all-weather access for water line easements not contiguous with public right-of-way.
- d. For water lines located outside of the public right-of-way:
 - (1) The easement shall be contiguous to the street right-of-way, or contiguous to a public utility easement that is contiguous to the street right-of-way.
 - (2) The minimum width of easement for lines 12 inches in diameter and smaller shall be 10 feet, and for lines 16 inches in diameter and larger shall be 20 feet.
- e. For water lines located inside of public right-of-way, less than 5 feet from right-of-way lines, the outside edge of a water line easement shall be located from the right-of-way line as follows:
 - (1) 12-inch diameter and smaller – minimum 5 feet
 - (2) 16-inch diameter and larger – minimum 10 feet
- f. Water lines along State rights-of-way shall be installed outside of the right-of-way in a separate contiguous easement. Width of easements shall be as provided in Paragraph 5.07.A.1.d.
- g. No backlot easements will be allowed for the installation of water lines.
- h. Commercial developments inside the City and in the ETJ requiring on-site fire hydrants must provide a minimum 20-foot water line easement for the water lines and fire hydrants.
- i. The nearest outside diameter of any water line shall be no closer to a building line, building foundation or building slab than 10 feet for water lines 12 inches in diameter and smaller and no closer than 15 feet for water lines 16 inches in diameter and larger.
- j. When using side lot easements, such easements shall be a minimum of 20 feet in width, located on one lot or centered between two lots. If centered between

two lots, the water line may be centered within the 10 feet of one lot, or centered in the easement.

2. Fire Hydrants:

- a. Use a minimum 10-foot by 10-foot easement for fire hydrants located outside of public rights-of-way.
- b. Do not locate fire hydrants in 10-foot-wide water line or water meter easements.

3. Meters and Valves:

- a. Two-inch and smaller meters and shut-off valves (stop boxes) shall be set within public rights-of-way or water line easement if possible. Otherwise, they shall be set in 5-foot by 5-foot water meter easements contiguous with public right-of-way.
- b. The minimum size of water meter easements contiguous with public right-of-way for three-inch through six-inch meters shall be 10-feet by 20-feet and for eight-inch and larger meters shall be 15-feet by 25-feet.
- c. Water meter easements shall be located contiguous with public rights-of-way unless approved by the City. Access easements a minimum of 15 feet wide will be required when not contiguous with a public right-of-way.

B. Easements for Wastewater Lines and Appurtenances.

1. Wastewater Collection Lines:

- a. Easements adjacent to public rights-of-way, easements, or fee strips, including those owned by HCFCD, Houston Lighting & Power Company, and pipeline companies.
 - (1) Easements for sanitary sewers 10 inches or less in diameter shall have a minimum width of 15 feet or a minimum width equal to the depth of the proposed sewer, whichever is greater.
 - (2) Easements for sanitary sewers 12 inches or greater in diameter shall have minimum width of 20 feet or a minimum width equal to the depth of the proposed sewer, whichever is greater.
- b. Sanitary sewer easements or other combined easements for sanitary sewers which meet the conditions below shall have a minimum width equal to twice the sewer's diameter plus the flow line depth of the sewer from natural

ground, proposed fill elevation, or 100-year Floodplain Fill Elevation, whichever is greater; but not less than 25 feet. The qualifying conditions are:

- (1) Runs through commercial reserves or across open country (acreage);
- (2) Serves other existing or proposed platted commercial reserves or non-platted acreage tracts; and
- (3) Is not immediately adjacent to public rights-of-way, easements, or fee strips, including those owned by HCFCD, Houston Lighting & Power Company, and pipeline companies.

- c. Sanitary sewers which cannot be located in the center of easements shall be located a minimum distance of half the depth from the nearest side of the easement.
- d. Sanitary sewers or force mains, installed in easements separated from public or semi-public rights-of-way by other private or utility company easements, shall be extended along or across the private utility company easement to provide access for maintenance of the sewer or force main.
- e. Easements described in Paragraphs 5.07B.1.a through 5.07B.1.e shall be open-ended easements in conformance with City Codes, Ordinances and Planning Requirements. Such open-ended sanitary sewer easements shall be extended if necessary and shall be fully connected at both ends to public facilities including existing or proposed:
 - (1) Public road rights-of-way
 - (2) Wastewater treatment plant sites
 - (3) Wastewater pump station sites
 - (4) Public utility easement of adequate size for maintenance access.

2. Force Mains:

- a. Force mains of all sizes shall have a minimum easement width of 20 feet for single lines which are not located adjacent to public or semi-public rights-of-way.
- b. Force mains located in easements adjacent to public or semi-public rights-of-way shall have a minimum easement width of 10 feet subject to location and depth of the force main.

3. Service Leads: The minimum easement for building service leads is 6 feet.

C. Storm Drainage Lines and Appurtenances

1. Storm Sewer Lines:

- a. To the extent practical, storm sewers shall be placed in public road rights-of-way or permanent access easements with overlapping public utility easements in accordance with Chapter 6, Utility Locations.
 - b. Storm sewers shall have a minimum 20-foot-wide easement. In the event of extreme depth or large sewers, additional width may be required to allow for proper maintenance operations.
 - (1) Maintenance operations require an easement width equal to the storm sewer width plus the depth rounded up to the nearest multiple of 5-feet.
 - c. Storm Sewers shall be centered within the limits of the easement.
2. Storm Water Detention Basins:
 - a. Easements for storm water detention basins shall be dedicated by plat or by separate instrument filed in conjunction with plat approval. Such easements shall be dedicated to the developer, owner, or water district.
 - b. Such easements shall have a minimum 20-foot width for private basins surrounding the perimeter of the detention basin as measured from top of bank unless adjacent to a street right-of-way.
- D. Easements for Combined Storm and Sanitary Sewer
1. Combined storm and sanitary sewer easement widths shall be as specified in 5.07C.1.b for storm sewer lines. The centerlines of sanitary sewer mains, trunks, or force mains shall be located in at least half the width of the easements defined in Paragraph 5.07B.1, but not less than 10 feet from the edge of the easement.
 2. The centerline of sanitary sewers on the outside of combined storm and sanitary sewer easements adjacent to public or semi-public rights-of-way, shall be located in at least half the width of the easement defined in Paragraph 5.07B.1.d, but not less than 10 feet from the outside edge of the easement.

END OF CHAPTER

City of Houston

Design Manual

Chapter 6

UTILITY LOCATIONS

Chapter 6

UTILITY LOCATIONS

6.01 CHAPTER INCLUDES

- A. Location of utilities in rights-of-way and easements.

6.02 REFERENCES

- A. Typical utility location in 10-foot-wide and 14-foot-wide easements in back-to-back lots and perimeter lots as detailed in the most current drawing prepared by the UCC.

6.03 DEFINITIONS

- A. Easements - Areas set aside for installation and maintenance of utilities by public and private utility companies.
- B. Water Lines - Closed conduits designed to distribute potable water for human consumption and to provide fire protection. Line size and fire protection accessory locations are dependent on distance from primary source and quantity demand.
- C. Wastewater Sewer Lines - Closed conduits designed to collect and transport wastewater from residential, commercial, and industrial sites to plants for treatment prior to discharge into open conduits. Wastewater lines may be designed as gravity (non-pressure) flow lines or force (pressure) mains. Gravity flow lines usually fall into three categories in ascending size from service line to lateral line to main line. Service lines (source of wastewater) may discharge into a lateral line or main line.
- D. Storm Sewer Lines - Closed gravity (non-pressure) conduits designed to collect and transport storm water from inlet locations to an open conduit outfall, ditch, creek, stream, bayou, river, holding pond, or bay. Inlets are surface mounted basins designed to collect and funnel storm water to the collection system. Storm sewers from the inlets to the collection system are usually defined as inlet leads.

6.04 DESIGN REQUIREMENTS

- A. Whenever practical, locate storm sewer, wastewater collection lines, water mains, and appurtenances within public rights-of-way in the manner described by this Chapter.
- B. Research and resolve known conflicts of proposed utilities with existing utilities.
- C. Locate back lot utilities in compliance with UCC recommendations.

- D. Identify water lines as to size, location, depth, and material on final design drawings. Also identify water line accessories, such as bends, valves, fittings, and fire hydrants as to type on the drawings.
- E. Identify wastewater sewer lines as to the size, location, depth, grade for gravity service, and material on final design drawings. Also identify wastewater sewer line accessories, such as manholes, cleanouts, and fittings, as to size and material on the drawings.
- F. Identify storm sewer lines as to size, location, depth, grade, and material on final design drawings. Also identify storm sewer line accessories, such as manholes, headwalls, and inlets as to size and material on the drawings.

6.05 SUBMITTALS

- A. Easements and rights-of-way are clearly identified for location and width on recorded plats. Off-site easements and rights-of-way shall be described by metes-and-bounds descriptions with accompanying drawings to clearly identify location and width. Final design drawings shall identify easements and rights-of-way as shown on recorded plats or by recorded metes-and-bounds descriptions.
- B. Water lines shall be identified on final design drawings with specific graphics and dimensioned from edge of easements and rights-of-way. The primary source of potable water shall be identified.
- C. Wastewater sewer lines shall be identified on final design drawings with specific graphics and dimensioned from edge of easements and rights-of-way. The outfall or discharge location shall be identified.
- D. Storm sewer lines shall be identified on final design drawings with specific graphics and dimensioned from edge of easements and rights-of-way. The outfall or discharge location shall be identified.
- E. Where the criteria for location of the utility is the clear distance between the outside edge of the conduit to easement or right-of-way line, show this controlling dimension.

6.06 QUALITY ASSURANCE

- A. Recorded metes-and-bounds descriptions and plats shall be prepared by or under the supervision of a Professional Surveyor. Recordable instruments shall be sealed, dated, and signed by the Professional Surveyor responsible for the preparation.
- B. Prepare calculations and final design drawings under the supervision of a Professional Engineer trained and licensed under the disciplines required by the scope of the project. The final construction drawings must be sealed, signed, and dated by the Professional Engineer responsible for the development of the drawings.

6.07 DESIGN ANALYSIS

- A. Back Lot Utilities: Identify type of electrical service and select the appropriate width of the easement. For mixed overhead and underground service select the 14-foot-wide easement to provide versatility.
- B. Water Lines.
 - 1. Water lines may be located within a public right-of-way, within a permanent access easement with overlapping public utility easements, within a dedicated easement adjacent to and contiguous with the right-of-way, or within separate dedicated water line easements, to meet the requirements of this manual. The location of the main shall be as specified in Chapter 7, Water Line Design Requirements.
 - 2. Water lines shall not be located in combination easements without approval of the City. Water line easements shall not be combined with wastewater sewer easements.
 - 3. Water main, with the exception of transmission lines, shall be located within the right-of-way between the property line and back of curb or in a dedicated easement adjacent to contiguous with the right-of-way.
- C. Wastewater Sewer Lines.
 - 1. Wastewater sewer lines shall be located in a public right-of-way, within a permanent access easement with overlapping public utility easements or within a dedicated easement adjacent to the public right-of-way. Side lot easements may be used when required. Backlot easements shall not be utilized except in cases of pre-existing conditions and with approval of the City.
 - 2. New developments will be required to comply with the requirement to locate wastewater sewer lines in compliance with Paragraph 6.07C.1.
 - 3. Wastewater sewer trunk or collector mains shall not be located in side lot easements without approval of the City.
 - 4. Wastewater sewer trunk or collector mains are usually located within the right-of-way between the property line and the back of curb or in a dedicated easement adjacent and contiguous with the right-of-way on the opposite side of the right-of-way from the water main.
- D. Storm Water Lines.
 - 1. Storm water lines shall be located within public rights-of-way, within a permanent access easements with overlapping public utility easements or approved easements.

Approval of the location for storm water lines should be obtained from the City prior to plan preparation.

2. Storm water lines are usually located within the right-of-way between the property line and back of curb on the opposite side of the right-of-way from the sanitary sewer. For boulevards streets with esplanades, the storm sewer may be located within the esplanade. Coordinate the proposed storm sewer alignment with water line location and future pavement widening.
3. New development projects by private participation will require the storm water trunk lines to be located outside the pavement section or in an approved easement. Any deviation of such requirements will require approval from the Office of the City Engineer.

6.08 OPEN-CUT CONSTRUCTION IN STREET PAVEMENT

- A. Construction documents shall require that one lane of traffic be open at all times with a flagman at both ends of the construction unless otherwise provided on an approved traffic control plan.
- B. For open-cut construction in street pavement, the drawings shall call for steel plate covers to be placed over open-cut sections whenever the contractor is not working within the open-cut area so that traffic will have full use of the roadway.

6.09 BACK LOT UTILITY LOCATIONS

- A. The basic utility locations for a 10-foot-wide back lot easement are as shown in Figure 6.1, Typical Utility Location in 10-foot-wide Residential Easement, prepared by the UCC. A portion of the drawing is reproduced here for reference. The basic utility locations for 14-foot-wide back lot easement is as presented in the May 15, 1996, UCC Memo of Understanding, and is reproduced here for reference as Figure 6.1, Typical Utility Locations in 10-foot-wide Residential Easement, and 6.2, Typical Utility Locations in 14-foot-wide Residential Backlot Easement.

END OF CHAPTER

FIGURE 6.1
 TYPICAL UTILITY LOCATIONS IN 10-FOOT-WIDE
 RESIDENTIAL EASEMENT

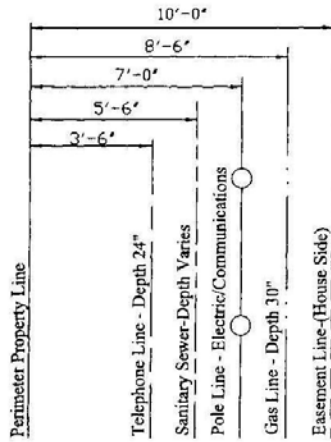

PERIMETER EASEMENT

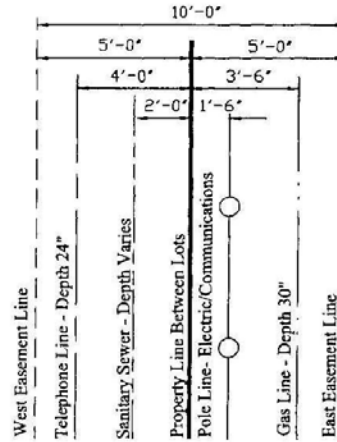

BACK-TO-BACK EASEMENT

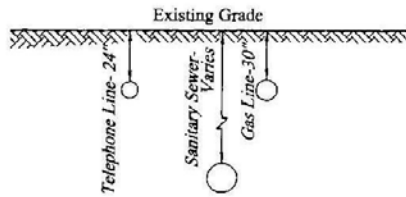

TYPICAL INSTALLATION
 DEPTHS

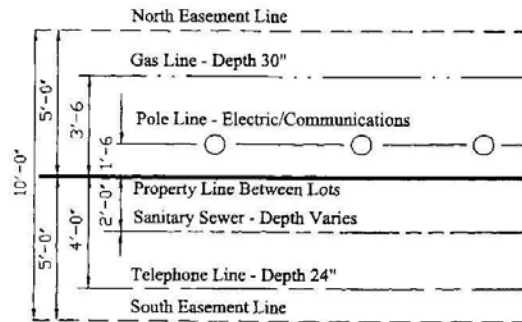

BACK TO BACK EASEMENT

NOTES:

- (1) Utilities are normally installed as shown but depth may vary due to fill or cut by others.
- (2) Maintain minimum 4" clearance between utility lines extending from easement to house/building.
- (3) Flexible base shall be 8" minimum hot mix asphaltic concrete (hmac).

FIGURE 6.2
 TYPICAL UTILITY LOCATIONS IN 14-FOOT-WIDE
 RESIDENTIAL BACKLOT EASEMENT
 (NO BACKLOT SEWER)

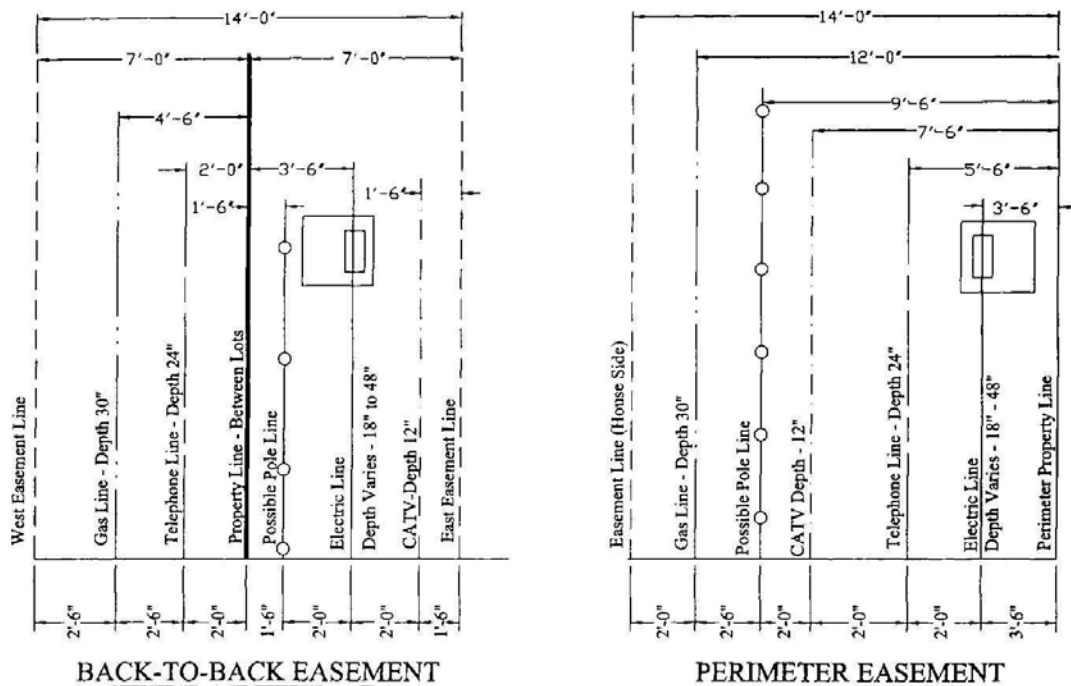

- NOTES:**
- (1) Utilities are normally installed as shown, but depth may vary due to fill or cut by others.
 - (2) Maintain minimum 4" clearance between all utility lines extending from easement to house/building.
 - (3) Always exercise extreme caution when digging in utility easements and on or across customer's property, because service lines extend from easement to house.
 - (4) 10' Utility Easements may be granted if approved by the Utilities and City Council.

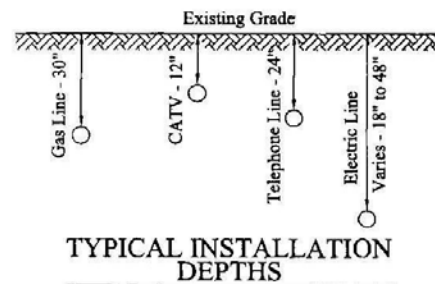

City of Houston

Design Manual

Chapter 7

WATER LINE DESIGN REQUIREMENTS

Chapter 7

WATER LINE DESIGN REQUIREMENTS

7.01 CHAPTER INCLUDES

- A. Criteria for the design of water lines.

7.02 REFERENCES

- A. American Water Works Association (AWWA).
- B. National Sanitation Foundation (NSF).
- C. Uniform Plumbing Code
- D. Refer to the list of references in Chapter 1, General Requirements.

7.03 DESIGN REQUIREMENTS

- A. Obtain approval from the Office of the City Engineer (OCE) for exceptions or deviations from these requirements. Exceptions or deviations may be granted on a project-by-project basis.
- B. Lines.
 - 1. Locate water lines within street rights-of-way, permanent access easements with overlapping public utility easements, easements adjacent to street rights-of-way, or recorded water line easements:
 - a. Pipe with 2-inch diameter is allowed only in rehabilitation projects where ties to existing 2-inch lines are necessary.
 - b. Pipe with 4-inch diameter may be used within cul-de-sacs (permanent dead end) less than or equal to 200 feet in length.
 - c. Pipe with 6-inch diameter may be used if the line is less than 1000 feet in length and interconnected between 2 lines which are 8-inch diameter or larger, or if the 6-inch line terminates in a cul-de-sac or dead end street and meets the additional rule of this chapter. Only one fire hydrant or flushing valve is allowed on any length of 6-inch diameter line.
 - d. Use minimum 8-inch diameter pipe for lines over 1000 feet long or when 2 or more fire hydrants or flushing valves are required.

- e. Pipes 12-inch diameter and larger shall be used as determined by the Professional Engineer and approved by OCE. A minimum of 12-inch diameter pipe shall be used when parallel to a Railway Transit corridor for more than 300 feet.
- f. Dead-end lines within public right-of-way:
 - (1) In temporary dead end situations the water line shall be 6-inch diameter or larger, shall not exceed more than 200 feet in length from the closest interconnection water line, and shall terminate with a fire hydrant or blowoff valve. The fire hydrant or blowoff valve shall be located considering adequate drainage to avoid flooding during flushing.
 - (2) In permanent dead ends situations the water line shall be 6-inch diameter or larger, shall not exceed more than 500 feet in length from the closest interconnection water line and shall terminate with a fire hydrant or blowoff valve. The fire hydrant or blowoff valve shall be located considering adequate drainage to avoid flooding during flushing.
 - (3) Water lines within cul-de-sac:
 - (a) Reduce pipe sizes successively. Carry 8-inch and/or 6-inch and/or 4-inch diameter pipe in accordance with requirements found in paragraph 7.03. The water line shall terminate with a fire hydrant and/or blowoff valve. Carry 6-inch diameter pipe to the last fire hydrant. If the water line continues beyond the last fire hydrant, use 4-inch diameter pipe to end the water line. The water line shall terminate with a standard 2-inch blowoff valve and box at the end of a 4-inch diameter water line. Place last service as near as possible to the end of water line. The fire hydrant and/or blowoff valve shall be located considering adequate drainage to avoid flooding during flushing.
 - (b) Use following alternate if approved or requested by OCE.
 - 1. Extend water line along both sides of the street and loop (connect both lines within the cul-de-sac turnaround).
 - 2. The diameter of the looped water line shall be of the same size as the diameter of water line perpendicular to the cul-de-sac. The diameter of the water line shall not exceed 8-inch within the cul-de-sac without approval from OCE.

3. Discontinue water line along perpendicular street between entry and exit locations of the looped water line so that water flow will occur down one side of cul-de-sac street and up the other side without disrupting the continuity of water flow.
4. Fire hydrants to be spaced as if only a single line existed.
5. Alternatively, extend water line to an adjacent cul-de-sac under the following conditions:
 - a. Obtain a separate 20-foot wide water line easement.
 - b. Install water lines inside a continuous steel casing pipe. Extend the casing uninterrupted from R.O.W. to R.O.W. No horizontal or vertical deflections or connections are allowed. Construct encased water line of restrained joint bell and spigot pipe to prevent lateral movement. Provide casing spacers and end seals in accordance with Standard Specifications.
 - c. Obtain approval from OCE.
- g. Install water lines that are located in side lot easements inside a continuous steel casing pipe. Extend the casing uninterrupted from R.O.W. to R.O.W. Diameter of pipe shall not exceed 12 inches. Provide isolation valves within 100 feet of each end. No horizontal or vertical deflections or connections are allowed. Construct encased water line of restrained joint bell and spigot pipe to prevent lateral movement. Provide casing spacers and end seals in accordance with Standard Specifications.

C. Location, Depth of Cover, and Separation Requirements

**Table 7.1
 WATER LINE LOCATION WITHIN A STREET RIGHT-OF-WAY**

RIGHT-OF-WAY WIDTH & EXISTING OR ANTICIPATED CURB FACE TO FACE PAVING WIDTH	8" & SMALLER^{(1) (2)}	12" THRU 20"^{(1) (2)}	24" & LARGER⁽⁴⁾
100-FOOT ROW (ALL STREETS):	8 feet	7 feet	10 feet
80-FOOT ROW (ALL STREETS):	7 feet	6 feet	10 feet
60-FOOT ROW:			10 feet
MAJOR THOROUGHFARE: 44 feet	5 feet	5 feet	10 feet
COMMERCIAL, SCHOOL, PARK 40 feet	7 feet	6 feet	10 feet
RESIDENTIAL: 27 feet	12 feet ⁽³⁾	12 feet ⁽³⁾	12 feet ⁽³⁾
50-FOOT ROW:			
ALL STREETS: 35 feet	5 feet	5 feet	10 feet
ALL STREETS: 27 feet	7 feet	7 feet	10 feet

(1) The number listed below is the maximum allowable distance from the right-of-way to the nearest outside diameter of the proposed water line.
 (2) The minimum distance from the right-of-way to the nearest outside diameter of the proposed water line shall be 5 feet without a water line easement adjacent to the rights-of-way (see easement requirements for less than 5 feet).
 (3) Investigate the possibility of a future 35-foot face-to-face curb-and-gutter section to replace existing streets with roadside ditches.
 (4) The number listed below is the minimum distance from the right-of-way to the nearest outside diameter of the proposed water line for 24-inch and 30-inch diameter lines. The number shall be the minimum distance to the nearest outside diameter for lines 36-inch in diameter and larger. See easement requirements for less than 10 feet.

1. Boulevard streets: When necessary, water lines may be located within the esplanade. The lines should be located as near the centerline of street right-of-way as possible to avoid conflict with future pavement widening.
2. Locations within an easement: Locate water lines 12-inch diameter and smaller in the center of a 10-foot minimum width dedicated water line easement and water lines 16-inch diameter and larger in the center of a 20-foot minimum width dedicated water line easement. Do not locate lines 16-inch diameter and larger in side lot easements. For location within side lot easements, see Chapter 5, Easement Requirements. Obtain approval from OCE for lines to be located in wider or multi-use easements.
3. When a water line and appurtenances is placed parallel or adjacent to another utility line, other than a sanitary sewer, and is located above the other utility, water lines and

appurtenances shall have a minimum of 4 feet horizontal clearance from outside wall to outside wall of the other utility.

4. When a water line and appurtenances is placed parallel or adjacent to another utility line, other than a sanitary sewer, and is located below the other utility, the water line 16-inch diameter and smaller shall have a minimum of 5 feet horizontal clearance from outside wall of the water line to outside wall of the other utility. Water lines larger than 16-inch diameter shall have a minimum of 4 feet horizontal clearance from outside wall to outside wall of the other utility.
5. When a water line is to be placed parallel to a railway corridor, maintain minimum 30 feet horizontal clearance from centerline of nearest outside track rail.
6. Do not place water line appurtenances in flow lines of the roadside ditches.
7. Depth of cover
 - a. Provide the following minimum depths of cover from the top of curb for curb-and-gutter streets or from mean elevation of the nearby ditch bottom and the nearby right-of-way for open-ditch section:

Table 7.2
DEPTH OF COVER FOR WATER LINES

SIZE OF LINE	DEPTH OF COVER		ABSOLUTE MINIMUM
	TOP-OF-CURB	OPEN-DITCH SECTION	
12-INCH & SMALLER	4 feet ⁽²⁾	5 feet	3 feet ⁽²⁾
16-INCH	5 feet ⁽²⁾	6 feet	3 feet ⁽²⁾
20-INCH & LARGER	6 feet	8 feet	4 feet ^(1,2)

⁽¹⁾ Cement stabilized embedment required.

⁽²⁾ Minimum 6 feet of cover where crossing railway

- b. Whenever possible, changes in grade or alignment to clear utilities or underground features should be accomplished by deflecting the pipe joints. The use of regular bends for any change in grade will not be allowed without prior approval from OCE for variance.
 - c. No vertical or horizontal offsets or bends allowed for water lines in casings.
 - d. Use restrained joint pipe for lines 20-inch diameter and smaller with less than 4 feet or more than 8 feet of cover. The following direct bury alternates may be used:
 - (1) Ductile iron pipe pressure 250 psi with approved restrained joints.

- (2) PVC pipe with integral restrained joint system, or ductile iron restrained joints fittings, epoxy lined and coated. Use AWWA C900 DR 18 for PVC restrained joints. Use 250 psi AWWA C900 DR 14 for vertical offsets.
- (3) Use only ductile iron and PVC products listed on OCE approved products list and/or in accordance with City Standard Specifications.

D. Appurtenances

1. Do not place appurtenances under pavement. Obtain approval from OCE for variances.
2. Valves
 - a. Spacing - set at maximum distances along the line as follows:
 - (1) 4-inch through 12-inch diameter - 1000 feet.
 - (2) 16-inch and 20-inch diameter - 2000 feet.
 - (3) 24-inch diameter and larger - obtain OCE approval.
 - b. Location:
 - (1) Normally, locate valves at street intersections along the street right-of-way lines projected across the water line. Tapping sleeves and valves are excluded from this requirement. Maintain a minimum of 30 feet from the centerline of the outside rail.
 - (2) Isolate fire hydrants and flushing valves from the water line with a valve located in the fire hydrant or flushing valve branch. This valve shall not be located in the slope or flow line of roadside ditches.
 - (3) Intermediate valves, not located on the projection of the right-of-way line, shall be located on lot lines or 5 feet from fire hydrants but not set in driveways.
 - (4) Locate valves a minimum of 9 feet horizontally from sanitary sewer crossings and 4 feet horizontally from other utilities crossings.
 - (5) Valves located near reducers shall be located on the smaller diameter pipe.
 - (6) Provide flanged outlet and mount isolation valve directly on the flange on any branches to larger diameter water line.
 - c. Valve Type (Unless otherwise specified):
 - (1) 16-inch and smaller - Gate valves.
 - (2) 20-inch and larger - Butterfly valves.
 - (3) Gate valves should be used for all meter installation.
 - d. Number of Valves:
 - (1) Total number of valves at any water line intersection shall equal total number of lines leading out from the intersection point minus one,

- three valves for a cross, and two valves for a tee for 20-inch diameter lines and smaller.
- (2) Total number of valves at a tee or cross for lines 24-inch and larger to be determined based on a project by project basis as approved by OCE.
3. Fire Hydrants and Flushing Valves
- Fire hydrants should be designed to maintain sufficient water pressure for service to adequately protect public safety in residential area. The system must also be designed to provide fire fighting capability to maintain a minimum pressure of 20 psi under combined fire and drinking water flow conditions. The minimum fire flow for the residential area should be 1,500 gpm.
- a. Spacing:
 - (1) Single-family residential development - 500-foot maximum spacing.
 - (2) All other developments - 350-foot maximum spacing.
 - b. Location in or along street right-of-way:
 - (1) Locate fire hydrants primarily at street intersections.
 - (2) Locate fire hydrants at PCS of the intersection curb radius, 3 feet behind curb or projected future curb.
 - (3) On streets with roadside ditches, set the fire hydrants within 5 feet of rights-of-way lines.
 - (4) Set intermediate fire hydrants on lot lines, as extended to pavement, when located between right-of-way intersections. These locations may be adjusted 5 feet either way to avoid driveways or obstructions. In either case, do not locate fire hydrants closer than 3 feet from curbed driveways or 5 feet from non-curbed driveways.
 - (5)
 - a. Fire hydrants may be set in the esplanade section of City streets when locations at back of curbs are not feasible. In such cases, the preferred location is 7 feet behind back of curb to provide access for parkway mower. In no instance shall the fire hydrant be closer than 3 feet from back of esplanade curb or closer than 10 feet from esplanade nose.
 - b. Fire hydrants shall not be located between parallel adjacent Rail Tracts in Railway Transit Corridor.
 - c. Location of fire hydrants or flushing valves outside and adjacent to street rights-of-way:
 - (1) The City Fire Marshall will establish and approve the location of fire hydrants and flushing valves in apartment complexes, platted private street developments, and other multi-family developments within the City.
 - (2) Locate fire hydrants and flushing valves in protected, easily-accessible areas behind curb lines.

- separate water meter easement contiguous with public right-of-way. Provide concrete meter boxes for meters located under sidewalks .
- b. Meters 3 inches to 6 inches: Locate in minimum 10-foot by 20-foot separate water meter easement contiguous with public right-of-way. Provide Plan and Profile for OCE approval.
 - c. Meters 8 inches and larger: Locate in minimum 15-foot by 25-foot separate water meter easement contiguous with public right-of-way. Provide Plan and Profile for OCE approval.
 - d. Separate tap and service lead shall be designed for each domestic meter. Meter, line size, and appurtenances shall conform to the latest edition of the Uniform Plumbing Code.
 - e. All water meters must have the same size as of the service lines except 4-inch and 12-inch diameter service lines shall be installed for 3-inch and 10-inch water meters.
 - f. Irrigation meters are to be branched off the domestic service.
 - g. Double detector check valves allowed for use on un-metered fire lines for closed type systems in accordance to the City of Houston Ordinance Chapter 47.
 - h. 3 inches and larger meters set in right-of-way or any placement other than the dedicated easement will require approval from the OCE.
 - i. Meters larger than 10 inches, or applications in potential hazardous chemical environs must be installed in an above ground meter installation assembly.
2. Refer to Submittals Paragraph 7.04, and Drawings Paragraph 7.07 of this Chapter, for approval and drawing requirements for meter service leads 4-inch diameter and larger, and metered sprinkler connections.
 3. For proposed apartments or townhomes in private street developments, provide one master meter sized for the entire development. Exceptions may be granted by OCE. If an exception is approved, do not interconnect multiple meters.
 4. Provide a dedicated water main easement for commercial developments with on-site water mains (for fire protection) or, provide fire service meters adjacent to the public right-of-way. If a dual feed is desired, both feeds shall be metered. An above-ground, reduced pressure, zone-type backflow preventer shall be installed on the water line downstream from the meters.

5. Do not install stub outs for future water services.
 6. Show meter sizes for 1-1/2 inch or larger water meters.
- F. Water Line Crossings
1. Public and private utility crossings other than sanitary sewer: Where a water line crosses another utility other than a sanitary sewer, a minimum of 12 inches of vertical clearance must be maintained between the outside wall of the water line and the outside wall of the utility.
 2. Stream or ditch crossings
 - a. Elevated crossings, general:
 - (1) Elevated crossings are preferred to underground crossings.
 - (2) Design elevated crossings with the elevation of the bottom of the water line above the low chord of the nearest adjacent bridge or a minimum 1-1/2 feet above the 100-Year Floodplain Elevation, whichever is greater.
 - (3) Water lines shall be steel pipe and shall extend a minimum of 15 feet beyond the last bend or to the right-of-way line of the crossing, whichever is greater.
 - b. Elevated crossings on existing structures:
 - (1) 12-inch diameter and smaller water lines supported on existing or proposed bridges, must meet the following criteria. Coordinate location of lines, in advance, with OCE.
 - (a) Have adequate structural capacity.
 - (b) Have sufficient clearance above bent cap elevation for installation under the bridge.
 - c. Elevated crossings on separate structures:
 - (1) Use a separate elevated supporting structure for 16-inch diameter and larger water lines unless otherwise approved by OCE. Locate separate structures a minimum of 10 feet clear from other existing or proposed structures.
 - (2) Support the line on columns spaced to accommodate structural capacity of the pipeline considering deflection and loading.
 - (3) Base column support design on soil capacity, spacing, loading, and structural requirements.
 - (4) Provide sufficient span length to accommodate the cross section of future widening of the stream or ditch, if available.
 - (5) Provide appropriately sized air release valves at the highest point of the water line.
 - (6) Provide pedestrian pipe guards on elevated crossings.

- d. Underground Crossings:
 - (1) Provide a minimum 5-foot clearance above top of pipe to the ultimate flow line of the ditch.
 - (2) Provide sufficient length to exceed the ultimate future development of the stream or ditch.
 - (3) Water lines shall be restrained joint pipe and shall extend a minimum of 15 feet beyond the last bend or to the right-of-way line of the crossing, whichever is greater.
 - (4) No water line underneath detention pond or amenity lake is allowed.
3. TxDOT and County Road Crossings
 - a. Extend carrier pipe from right-of-way to right-of-way.
 - b. Use restrained joint pipe in steel casing under existing and future roadway from a point 5 feet outside of the service road or outside of pavement toward the right-of-way, to a similar point on the other side of the highway across the right-of-way. For highway or roadway crossings with open-ditch sections, extend restrained joint pipe in steel casing from right-of-way to right-of-way.
 - c. Where additional right-of-way has been acquired, or is being acquired, for future widening, the restrained joint pipe in steel casing shall extend to within 10 feet of each right-of-way line.
4. Railroad Crossings
 - a. For mainline and spurline railroad crossings, the water line material shall conform to Railroad requirements and have restrained joint pipe within a casing which extends no less than 30 feet from the center line of the outside rails within City of Houston right-of-way, and from right-of-way to right-of-way, on railroad owned property.
 - b. Install isolation valves on each side of rail crossings.
 - c. Crossings are to be made perpendicular to rail.
 - d. Design Engineer to use a Corrosion Consultant to evaluate pipe and casing materials and the effect to and from rail systems.
5. Additional Requirements
 - a. Use electrically isolated flange joints for transitions between two dissimilar metallic pipes. Electrically isolate water lines from casing pipe and supports.

2. Provide a source of fresh water at each end or at multiple points of a subdivision. Provide ways to create circulation and place valves and fire hydrants to allow simple flushing of lines.

I. Interconnections

1. For interconnections between utility districts outside the City, written approval must be given by the TCEQ.
2. A written agreement between the districts must be approved by the City and recorded in the county records and furnished to the City.
3. Set meter at the point of connection in a separate easement sized to conform to requirements of Chapter 5. Meter to conform to requirements given in the City of Houston Standard Specifications and Standard Details.
4. Requirements for installation of a meter may be waived by the City, if provisions are made in the agreement between the districts. In this event, a separate easement, sized to conform to requirements of Chapter 5, and valves shall be provided for future meter installation.
5. Agreement between districts shall provide for annexation of the meter site by one district and shall require the installation of a meter. The installation and full cost shall be provided by the district not annexing the meter site.
6. For connection to City water lines serving districts or areas outside the City, written approval must be obtained from the TCEQ. No customer may take pump suction directly from City water lines. If a customer has his own well or other supply, an appropriate backflow preventer must be installed to prevent water from flowing into City water lines. Conform to the procedures for connection to City water lines in effect at the time of connection. Consult with the Public Utilities Division for current requirements.

J. Water Lines Separation from Sanitary Sewers

1. Proposed Water Lines Parallel to Gravity Sanitary Sewers and Force Mains:
Locate water lines a minimum of 9 feet horizontally apart, measured from outside wall to outside wall, when parallel to gravity sanitary sewers and force mains. Use the following procedure when stated separation cannot be achieved:
 - a. The existing sanitary sewer shall be replaced with lined ductile iron pipe or PVC pipe meeting ASTM specifications, having a minimum working pressure rating of 150 psi or greater and equipped with pressure-type joints.

- b. The water lines, gravity sanitary sewers, or force mains, shall be separated by a minimum vertical distance of 2 feet, and a minimum horizontal distance of 4 feet, measured between the nearest outside walls of the pipes. Locate 20-inch diameter and smaller water lines above gravity sewer lines.

Following alternate shall be used only, if the above can not be achieved

- c. Water line shall be constructed with approved restrained joints in an approved casing with at least two nominal sizes larger than the carrier pipe. The carrier pipe shall be supported at five-foot intervals with spacers or be filled to the springline with washed sand.
2. Proposed Water Lines Crossing gravity Sanitary Sewers and Force Mains. Conform to requirements of TAC § 290.44 Paragraph (e).
 - a. No protection is required if the sanitary sewer is 9 feet below the water line.
 - b. For all other cases, use Table 7.3 below.

Table 7.3
PROTECTION REQUIREMENTS AT
WATER LINE (WL) - SANITARY SEWER (SS) CROSSINGS

	PROPOSED WATER LINE				PROPOSED SANITARY SEWER			
	OVER		UNDER		OVER		UNDER	
	EXISTING SS	PROP SS	EXISTING SS	PROP SS	EXISTING WL	PROP WL	EXISTING WL	PROP WL
Minimum 2 feet vertical clearance	√ ¹	√ ¹	√	√	Not Allowed	√	√ ¹	√ ¹
Place 1 full section (min 18 ft) of WL centered at SS Crossing. Provide restrained joints on WL, spaced at least 9 ft horizontally from centerline of SS	√	√	√	√		√		√
Place 1 full section (min 18 ft) of SS centered at WL Crossing. Provide restrained joints on SS, spaced at least 9 ft horizontally from centerline of WL		√					√	√
Replace 1 full section of existing SS with pressure-rated DIP or pressure-rated PVC pipe with adapters and restrained joints centered at WL crossing	√ ^{2, 3}		√ ³					
Provide DIP for small diameter WL (less than 24 inches), PVC pipe is only allowed if encased as per TAC § 290.44, and use restrained joints for both DIP and PVC pipe			√	√		√		
Embed SS with CSS for the total length of 1 pipe segment plus 1 foot beyond the joints on each end	√ ^{2, 3}	√ ⁴	√ ³	√ ⁴		√ ⁴	√ ⁴	√ ⁴
Place 1 full section (min 18 ft) of min 150 psi SS centered at WL crossing. Provide restrained joints on SS, spaced at least 9 ft horizontally from centerline of WL or encase in a joint of 150 psi pressure pipe (min 18 ft) two nominal sizes larger with spacers at 5 ft interval.				√		√		

1. Minimum clearance is 2 feet for non-pressure rated SS and 1 foot for pressure rated SS
2. Required if existing SS is disturbed and /or there is evidence of leakage
3. Not required for augered WL unless there is evidence of leakage; completely fill augered hole with bentonite/clay mixture
4. Not required for augered SS; completely fill augered hole with bentonite/clay mixture

Note:

- a. Both water lines and wastewater main or lateral must pass a pressure and leakage test as specified in AWWA C600 standards
- b. Sanitary sewers (SS) is applicable to both gravity sanitary sewers and force mains.

3. Sanitary Sewer Manholes: Provide a minimum 9-foot clearance from outside wall of existing or proposed manholes unless manholes and connecting sewers can be made watertight and tested for no leakage. If a 9-foot clearance cannot be obtained, the water line may be located closer to the manhole when prior approval has been obtained from OCE by using one of the procedures below; however, in no case shall the clearance be less than 4 feet.
 - a. Water line shall be constructed with approved restrained joints in an approved casing with at least two nominal sizes larger than the carrier pipe. The carrier pipe shall be supported at five-foot intervals with spacers or be filled to the springline with washed sand.
4. Fire Hydrants: Do not install fire hydrants within 9 feet of sanitary sewers and force mains regardless of construction.
5. TCEQ Rules and Regulations for Public Water Systems, including any approved City variances shall apply if they are more strict than these guidelines or if they are not covered by these guidelines.

7.04 SUBMITTALS

- A. Conform to the following submittal requirements in addition to those of Chapter 1 - General Requirements.
- B. Water Line Sizes: Submit justification, calculations, and locations for proposed water lines, for approval by OCE.
- C. Water Meter Service
 1. For construction inside city limits, submit an application for meter services and metered sprinkler connections, to the Taps and Meters Section, prior to construction.
 2. Submit requests for more than one service meter for townhomes in proposed private street developments to OCE.
- D. Master Development Plan: For multiple phase developments, submit a master development plan. If within the ETJ, submit an overall district plan prior to the drawings being submitted for first phase construction.
- E. Interconnections
 1. Submit to the TCEQ requests for written approval of:
 - a. Connection of City water lines to serve districts or areas outside city limits.

- b. Interconnections of districts.
2. Submit copies of approvals received from TCEQ to OCE.

7.05 QUALITY ASSURANCE

- A. Prepare calculations and construction drawings under the supervision of a Professional Engineer trained and licensed under the disciplines required by the drawings. The final design drawings must be sealed, signed, and dated by the Professional Engineer responsible for development of the drawings.

7.06 DESIGN ANALYSIS

- A. Water Line Sizes: Analyze system requirements to determine line sizes.
- B. Water Distribution System: The system must be designed to maintain a minimum pressure of 35 psi at all points within the distribution network at flow rates of at least 1.5 gpm per connection. The system must also be designed to provide fire fighting capability to maintain a minimum pressure of 20 psi under combined fire and drinking water flow conditions.
- C. Elevated Stream, Ditch, or Aerial Crossings: Prepare appropriate design calculations for the supporting structure.

7.07 DRAWINGS

- A. Conform to the following drawing requirements in addition to those of Chapter 3, Graphic Requirements and the City's standard water line details and Standard Specifications.
- B. Provide a cross section drawing (plan and profile showing other utilities and pavement) of branch water lines that extend perpendicularly from main water lines when:
 1. Branch line extends 20 feet or more, and/or
 2. Branch lines have vertical bends.
 3. When proposed lines, including services larger than 2-inches, cross Railway Transit facilities.
 4. Any water taps size 4" or larger.
- C. Appurtenances: Identify, describe, and enclose in rectangular box on drawings.
 1. Valves
 - a. Designate 2-inch through 16-inch gate valves with box as GV&B.

- b. Provide complete description and size for other valves.
 2. Water meters, service leads, and un-metered sprinkler connections
 - a. Show the location of service line tees, tapping sleeve and valves, valve boxes, and temporary plugs to be installed to serve future 3-inch diameter or larger meters.
 - b. Develop plan and profile sheets for 4-inch diameter and larger leads and connections.
- D. Construction Features
 1. Show special construction features required to complete the project in a safe, convenient, and economical manner.
 2. Trenchless Construction
 - a. If the construction is predominately open cut, all portions and locations of the street that must be trenchless constructed shall be clearly shown on drawings. Include designation for trenchless sections adjacent to trees with 6 inches or larger diameters located within 10 feet of water line.
 - b. If construction is predominately by trenchless construction:
 - (1) Clearly show on drawings, areas and locations in which trenchless pits will not be permitted.
 - (2) Clearly identify areas where special pipe material or offset sections are required to comply with these guidelines.
 3. Do not locate horizontal bends within street intersections between curb returns or within 30 feet of the centerline of the outside rail.
 4. Pedestrian Facilities: Include a requirement on drawings to replace any pedestrian facility that is disturbed, such as curb ramp, sidewalk, driveway or crosswalk in conformance with the latest edition of the City of Houston's Standard Details, American with Disabilities Act and Texas Accessibility Standards.
- E. Future Planned Improvements.
 1. When feasible, show planned improvements by City, County, TxDOT, Metro which could impact the proposed water line, or aspects of its design.

END OF CHAPTER

City of Houston

Design Manual

Chapter 8

**WASTEWATER COLLECTION SYSTEM
DESIGN REQUIREMENTS**

Chapter 8

WASTEWATER COLLECTION SYSTEM DESIGN REQUIREMENTS

8.01 CHAPTER INCLUDES

- A. Criteria for the design of wastewater collection systems.
- B. This Chapter addresses the design of the wastewater collection systems within the public Right-Of-Way or a dedicated public easement. Sanitary sewers located on private property that are not in such a dedicated easement, are under the jurisdiction of the Plumbing Code, and will be reviewed by the Code Enforcement Branch.

8.02 REFERENCES

- A. Refer to the list of references in Chapter 1, General Requirements.
- B. City of Houston Engineering Design Manual for Submersible Lift Stations.
- C. City of Houston Design Guideline Drawings for Submersible Lift Stations.
- D. Uniform Plumbing Code, latest edition adopted by the City.

8.03 DEFINITIONS

- A. Public Sewer - A closed conduit which conveys wastewater flow and which is located within the public Right-Of-Way or dedicated public sanitary sewer easement. A public sewer (or public sewer system) is intended to serve more than one residential, commercial, or industrial site.
- B. Private Sewer - A closed conduit which conveys wastewater flow and is constructed and maintained by a private entity (i.e. homeowner's association). Private sewers may be located in areas such as a private street or common area. Private sewers are subject to the design and construction requirements of the Plumbing Code and must discharge to a public sewer.
- C. Sewer Line –A public sewer located within public Right-Of-Way or Permanent Access Easement (PAE) / Public Utility Easement (PUE) that is maintained and operated by the City.
- D. Service Lead – The sewer pipe that connects a building sewer to a sewer line that is wholly located within the public Right-Of-Way or public easement. Such a line shall never exceed 150-feet in length, for lengths greater than 150-feet refer to definition for sewer line. No more than the equivalent of two single-family residences may be served at one time.
- E. Building Sewer – The sewer pipe that connects a building to a service lead that is wholly

located within the private property. If routed through another tract of land, it shall be located in a building connection easement. If located within a private easement, the City must be included as a third party in the easement documents. It will be owned and maintained by the owner of the property being served. Design shall adhere to the Design Manual or Plumbing Code, whichever is more stringent.

- F. Community sewer – A private sewer that serves more than 2 equivalent houses will adhere to this manual using an 8-inch pipe terminating in a manhole and will have an easement dedicated for the community sewer, which allows a property owner to extend a private sewer or service across adjacent property, or properties, to facilitate connection to a public sewer. If located within a private easement, the City must be included as a third party in the easement documents. It will be owned and maintained by the owner of the property being served by the private sewer.
- G. Project Area – The area in the immediate vicinity of a public sewer to be constructed. This includes the entire road Right-Of-Way and any adjoining easements used for the proposed wastewater line construction.
- H. Stack – A minimum 6-inch riser pipe, constructed on public sewer or lead, with a maximum of 6-feet of cover on the stack. A stack will be used for connecting service leads to a deep sewer line.
- I. Stub-Outs- A minimum 5-feet of sewer pipe extended from the manhole for future expansion and terminated with a sanitary sewer plug.
- J. Force Main– A pressure-rated conduit which conveys wastewater from one pump station () to one discharge point.

8.04 DESIGN REQUIREMENTS

- A. Drawings to be furnished
 - 1. To obtain a permit for the construction of a proposed sewer line or service lead crossing a public Right-Of-Way to an existing sewer line, a plan –and profile drawing of the proposed sewer shall be prepared and submitted to the City for approval.
- B. Drawing/Design Information
 - 1. The detailed drawings will show the exact location of the proposed line in the street, alley, or easement with respect to the edge of the particular Right-Of-Way, the transit base line, any nearby utilities, 100-year flood elevation within the project area, major landscaping, and other structures affecting construction.
 - 2. Sewers and manholes shall be identified by number, letter, combination of, or other identification and shown on the sanitary sewer layout sheet.

3. Where sewers are to be placed between existing pavement and the street Right-Of-Way line (or interior easement line) show the existing ground line at both sides (or the closest side for sewers near the edge) of the Right-Of-Way or adjacent sewer easement. Prior approval will be required if proposed sewers are to be placed under existing pavements or toppings.
4. For connection to the City sanitary sewer system include one of the following: a copy of the City's Wastewater Capacity Reservation (WCR) letter or, a copy of the City's Wastewater short form, and a Wastewater Impact Fee Receipt for any proposed wastewater design.

C. Drawing Requirements

1. All sewers and connections must be shown in both plan-and-profile views.
2. The profile shall show other underground and surface utilities and facilities, both in parallel and at crossings; the size, grade of the proposed line, the elevations of the proposed line to hundredths of a foot at manholes, changes of grade and dead ends; and the proposed finished grade over the sewer. It shall show the actual ground line as it exists prior to construction of the sewer. Where proposed fill or cut is contemplated, the proposed new ground line shall be shown as a separate line from the actual ground line (label both lines and use contrasting line types to identify each). Type of pipe and bedding shall comply with City of Houston Standard Specifications and Standard Details.
3. Commercial sanitary sewer layout sheets for large areas and with a scale of 400 feet or more per inch must have an additional set of layout sheets at not more than 200 feet per inch, with match lines and a small index map showing which portion of the overall layout that the layout of each sheet represents.
4. A scale of not more than 200-feet per inch on the layout sheet will provide the following information:
 - a. All easements containing or adjoining sanitary sewers are shown and labeled (including recording information),
 - b. Label locations where pipe size or material change,
 - c. Identify manhole by letter and/or number,
 - d. The sewer alignment shall accurately reflect the relative location of the sewer as shown on the detailed plan view,
 - e. Service leads that cross street pavement or serve adjacent property are to be shown on the layout. The detail plans and profiles shall show the flow lines of service leads at the street or easement Right-Of-Way, as well as at manholes where private sewer connections are allowed or required,

- f. The number and size of the lots depicted on both the overall sewer layout sheet and the individual plan-and-profile drawings shall match the number and size of the lots depicted on the final plat after recordation,
 - g. The size and direction of flow for existing and proposed sewers shall be shown on the overall sanitary sewer layout sheet,
 - h. The location of the proposed sewer within the public Right-Of-Way, easement adjacent to the public Right-Of-Way, or side lot easement (if allowed by the City), and
 - i. The overall sanitary sewer layout sheet shall show the area, in acres, which the proposed sewer is designed to serve. Include a location map which references the acreage to nearby major thoroughfares and boulevard streets. The scale used for the project area location map shall be: 1" = 2000' or less and shall be shown on the map.
5. The plan view shall show, at a minimum, the following information for the project area:
- a. Topographical features,
 - b. Stationing for the proposed sewers,
 - c. Existing buried and overhead utilities (i.e. gas, electric, telecom, etc),
 - d. Any significant landscaping or other structures which might impact construction or construction-related activities,
 - e. The width and type of existing and proposed easements,
 - f. Proposed service leads,
 - g. The limits of the proposed bore or tunnel,
 - h. Locations where pressure pipe is to be installed for water line crossings, and
 - i. Terrain changes, retaining walls, overhangs, buildings, billboards and any other structure within 25 feet of the proposed line.
6. The profile view shall show, at a minimum, the following information for the project area:
- a. Underground and surface utilities/facilities which are either parallel to the proposed sewer or cross the proposed sewer,
 - b. The proposed sewer's diameter, grade and length for each manhole section,

- c. The flow line elevation for sanitary sewers and service leads at each manhole,
 - d. The rim elevation of existing and proposed manholes,
 - e. The flow line elevation at each sheet match line (i.e., from one sheet to another),
 - f. Type of pipe bedding and backfill shall be included in the Standard Details,
 - g. The finished grade for proposed and existing pavement. Where cut and fill are proposed, the proposed new ground line should be shown as a separate line from the existing ground line (label both lines and use contrasting line types to identify each),
 - h. The existing ground line for the near side of the public Right-Of-Way where a sewer is to be placed between the edge of existing pavement and the edge of the public Right-Of-Way,
 - i. The existing ground line at the centerline of the proposed sanitary sewer where a sanitary sewer is to be placed within an easement. Show any proposed cut and fill as described above. Show the finished grade of any proposed and existing pavement,
 - j. The flow line elevation of service leads where the service lead crosses the edge of the public Right-Of-Way or the dedicated easement adjacent to the public Right-Of-Way,
 - k. Locations where pressure pipe and/or casing is to be installed for water line crossings or special conditions (i.e. limited clearance, special protection requirements, etc.),
 - l. The limits of special backfill and proposed stacks shall be identified by stations indicated on the design plans, and
 - m. Vertical elevation breaks in profiles shall not be used without clearly identifying breaks on each sheet and dimension the break line elevation difference.
7. Drawings for single-family residential subdivisions shall show the proposed location, by stations, of all service leads, and stacks.

D. Service Leads

1. Service leads shall be located either at the side property line between two adjoining lots, or as directed by the City. A single 6-inch service lead located at the property line between two adjoining lots would serve two single-family residences with a wyes

placed at the end of the service lead. Do not extend the wyes beyond the edge of either the public Right-Of-Way or dedicated public easement.

2. Service leads measuring more than 50-feet in length and parallel to the street Right-Of-Way or public sewer easement shall be treated as a public sewer line having both a starting and ending manhole, except for cul-de-sac(s)'.
3. Service leads for single-family developments shall not connect to a manhole unless otherwise stated in this manual. Private sewers from developments with more than 5000 gallons-per-day flow shall discharge into a proposed or existing manhole. Where the flow line of the private sewer is 24-inches or greater above the flow line of the manhole, provide a standard City of Houston outside drop to the manhole. Some design exceptions or additional requirements may be made for flow connections to large (36-inch and larger ID sewers) or deep (>20 feet flow line depth) sewer lines, depending on the individual circumstances.
 - a. Service leads shall be provided to serve every lot within a proposed development, whether inside the city limits or in the ETJ. Provide detail(s) for all typical near-side and far-side sewer connections, including 1-side or 2-sided stacks.
 - b. Service leads shall be 6-inches in diameter (minimum). If the length of a service lead exceeds 100-feet or the width of the public Right-Of-Way by more than 20-feet, the minimum diameter shall be 8-inches and a manhole shall be utilized for connection to the public sewer. Service leads exceeding 150-feet in length shall be designed as a sewer line.
 - c. Service leads with a diameter of 6-inches shall utilize full body fittings (extruded or factory-fabricated) for connection to a proposed public sewer or an approved saddle-type connector for connection to an existing public sewer.
 - d. Saddle-type connectors shall be installed with the stub oriented between the spring line (3 o'clock and 9 o'clock positions) and 45 degrees from the spring line (1:30 and 10:30 positions). Full body fittings used to connect a service lead to a proposed public sewer shall be oriented in the same manner.
 - e. The service lead shall be designed to minimize the use of bends as conditions permit.
 - f. Service leads exceeding the limits defined in Paragraph 8.04.D.2 shall have a manhole at each end; as well as a plan-and-profile drawing for each Right-Of-Way crossing. All or part of these service leads which are located in a public Right-Of-Way, alley or dedicated sanitary sewer or public utility easement(s) may be treated as a public sewer; depending upon the location of the terminal manhole and any intermediate manholes.

- g. For existing lots (which are not served in accordance with these guidelines) that requests a sewer connection and the distance to the nearest existing sewer is less than 50 feet, as measured parallel to the street Right-Of-Way, the sewer connection is under the jurisdiction of the Uniform Plumbing Code, (latest edition) provided that: a road bore is not required or a major thoroughfare (or collector) road is not being cut, both of which require City approval and an engineering drawing.
- h. The location where the service lead crosses the property line shall be shown on the plans and marked in the field. Provide a typical detail of the durable marker to be placed where the service lead crosses the property line.
- i. All private sewers, private force mains, and appurtenances, thereto, that is intended to be located inside the public Right-Of-Way must have an encroachment permit with plan and profile sheets.

E. General Requirements

1. Connect service leads to stacks, wyes or tees as shown on the City's Geographic Information Mapping System (GIMS). Where none are shown, a licensed plumber is responsible for placing a City approved saddle for connection to the public sewer and the City Inspector is responsible for determining that the saddle is watertight and properly installed.
2. Materials and construction shall conform to latest City of Houston Standard Specifications, including standard leak test.
3. Unless noted otherwise, all public sewers and service leads shall be embedded in cement-stabilized sand from 6-inches below the pipe to 12-inches above the pipe and for the full trench width. All such bedding shall be compacted to the density required by Standard Specifications. Cement-stabilized sand shall have a 48-hour compressive strength of 100 psi minimum. The cross-section described in this paragraph is defined as the pipe embedment zone.
4. Backfill excavated areas and trenches under or within one foot of existing or proposed pavement with cement-stabilized sand from the top of the pipe embedment zone up to one foot below the paving sub-grade. Cement-stabilized sand must develop 100 psi minimum compression at 48 hours. Backfill shall be compacted to 95 percent standard Proctor density.
5. The actual location of all special backfill and of proposed stacks shall be shown by stations on the drawings.
6. Public sewers and force mains shall be located in either the public Right-Of-Way or easements. Side lot easements may be used only with special approval. Back lot easements shall not be utilized except in the case of preexisting conditions or as

approved by the City Engineer.

7. Generally, the location of the public sewer within a dedicated easement shall be along the centerline of the easement. However, in those instances where the easement is adjacent to the public Right-Of-Way, the location of the sanitary sewer and its manholes shall be approved on a case-by-case basis by the Director Department of Public Works and Engineering, or his designee. Required easement widths are addressed in Chapter 5, Easement Requirements. Additional information regarding the location of sanitary sewers is contained in Chapter 6, Utility Locations.
8. The final determination as to that portion of a street, alley, or sanitary sewer easement to be occupied by a proposed sewer or force main rests with the City. The Director or designee will take into consideration existing, planned and proposed facilities such as manholes, pavement, pipes/conduits, along with existing trees and shrubs, or other unique surface conditions when arriving at a decision.
9. There shall be no closed-end easements for public sanitary sewers and force mains.
10. The drawings for the sewer shall show the location of any pipe, duct, other structure(s), hazardous obstacles and/or protected vegetation known to exist that might interfere with the construction of the sewer and call to the attention of the City any known obstacles that might be encountered in constructing the sewer in any location under consideration. The Professional Engineer of Record shall determine the existence of pipes, ducts, and any above stated obstacles by visually inspecting the site, researching all available public and private records, and conducting subsurface investigations when necessary.
11. Manholes located within the 100-year floodplain shall be sealed and vented per TCEQ requirements Engineering judgment and aesthetics should be considered.
12. Manholes located within driveways shall be sealed and vented per TCEQ requirements.
13. New manholes shall not be located within ditches, swales, unless approved by the City.
14. Wastewater lines along State Right-of-Way shall be installed outside of the right-of-way in a separate contiguous easement; width of easement shall be as provided in Chapter 5.

F. Line Size

1. The minimum pipe diameter for a public sanitary sewer shall be 8-inches.
2. Service leads 4-inches in diameter shall be confined to the limits of the lot which they serve and shall serve only the equivalent of one single-family lot. No 4-inch sewer shall be laid in any street, alley, or Right-Of-Way.

3. Service leads 6-inches in diameter shall not serve more than the equivalent of 2 single-family lots or other types of small land tracts.
4. Service leads of 6-inch and 8-inch diameter for single-family residential lots shall have a minimum grade of 0.70 percent and 0.44 percent respectfully.
5. For commercial service leads that requires a street bore, submit a copy of the wastewater capacity letter to establish the required size of the line. The minimum size service lead shall be 8-inches in diameter for the central business district and 6-inches in diameter elsewhere. Connect new central business district service leads directly to a manhole.
6. Sewer lines shall be laid at a size and depth to conform to designs permitting an orderly expansion of the sewer system of the City and so as to avoid a duplication of lines in the future.
7. The City shall be the final judge as to size and depth required and any exception to service leads as previously defined.

G. Line Depth

1. Sewer line shall be laid with the top of the pipe a minimum of 3-feet below the surface of the natural ground without side ditches.
2. Sewers laid in the street Right-Of-Way with curb and gutter paved streets shall have a minimum cover of 4-feet from the top of the pipe to top of the curb.
3. Sewers laid in street Right-Of-Way with crowned roads and side ditches shall have a minimum cover of 6-feet from the average ground line at the adjacent street Right-Of-Way to the top of pipe.
4. Where the minimum cover as specified in Paragraphs 8.04.G.1, 8.04.G.2, and 8.04.G.3 is not possible, the sewer shall be laid with Class 150 (150 psi) pressure pipe with cement-stabilized sand backfill as shown in Standard Details. Ductile iron pipe shall be lined with a material listed on the City of Houston Approved Product List and applied by either the pipe manufacturer or an approved applicator. Liners shall meet requirements of TCEQ 217.56(c)
5. Maximum depth for 8-inch, through 12-inch diameter collection lines shall be 20-feet from average ground surface of the trench width to pipe invert. Depths greater than 20-feet are subject to approval by the City Engineer if justified for site-specific reasons during the preliminary engineering phase of the project design.

H. Line Grades

1. The following table lists the minimum grades for 6-inch to 27-inch diameter public sewers. (6-in. diameter is for service leads only). The minimum grade is based on a

minimum full pipe velocity of 2.3 feet per second (fps). The maximum grade is based on a maximum full pipe velocity of 4.5 fps. In both cases, the Manning Formula has been used with an n coefficient of 0.013. The use of different pipe materials will not alter the use of 0.013 for the purposes of the Design Manual.

**Table 8.1
GRADES FOR WASTEWATER LINES**

NOMINAL INTERNAL PIPE DIAMETER (INCHES)	MINIMUM GRADE TO DEVELOP V= 2.3 FPS (PERCENT)	MAXIMUM GRADE TO DEVELOP V=4.5 FPS (PERCENT)
6	0.70	2.46
8	0.44	1.73
10	0.33	1.21
12	0.26	0.97
15	0.19	0.72
18	0.15	0.57
21	0.13	0.46
24	0.11	0.38
27	0.09	0.33

2. For sewers larger than 27-inches in diameter, the Professional Engineer of Record shall determine the appropriate grade utilizing the Manning Formula, $n = 0.013$ and a minimum full pipe velocity of 3.0 fps.

I. Line Alignment

1. Gravity sewers shall be laid in straight alignment with uniform grade between manholes. Deviations from straight alignment shall be justified by complying with the TCEQ requirements and approved by the City. Deviations from uniform grade without manholes shall not be allowed.

J. Manholes

1. Type: Manholes shall be precast concrete, per Standard Details; unless the Professional Engineer of Record submits a cast-in-place manhole design for review and approval by the City. The Professional Engineer of Record shall determine the need for a liner or coating on concrete manholes. Liner or coatings will be in accordance with the approved products as determined by the City of Houston Standard Products Committee. Fiberglass manholes, per Standard Details, are allowed outside the street Right-Of-Way. Precast manholes shall incorporate a boot-

type connector for sewer diameters up to 24-inches. For sewer diameters greater than 24-inches, utilize either the boot-type connector (if available) or an integral gasket. Precast manholes shall conform to the latest ASTM requirements. Manhole covers shall be 32-inches as shown in the Standard Details.

2. Location: For public sewers, manholes shall be placed at changes in alignment, changes in grade, junction points, and either at street, alley, or easement intersections as designs may require.
 - a. Sewers laid in easements shall have a manhole in each street crossed by the sewer.
 - b. The maximum distance between manholes shall be determined from the following table for 8-inch to 48-inch pipe diameters. Spacing for manholes on mains with diameters larger than 48-inches installed by tunneling methods or open-cut methods shall be determined on an individual project basis.

**Table 8.2
MAXIMUM DISTANCE BETWEEN
SANITARY SEWER MANHOLES**

PIPE DIAMETER (I.D.) IN INCHES	MANHOLE MAXIMUM SPACING IN FEET
8-15	400
18-48	800
Greater than 48	As approved by the City

- c. A design objective is to have sewers with the same, or approximately the same, flow line elevation intersect each other at a 90-degree angle. However, where a true perpendicular intersection cannot be obtained, and where the entering sewer intersects the receiving sewer at, or about, the same flow line elevation, one or more manholes shall be located so that a minimum angle of 80 degrees at the point of intersection can be achieved for the sewer line. When the entering sewer is on the upstream side of the manhole, the minimum angle between the sewers may be reduced to a 45-degree angle provided:
 - (1) A distinct flow channel can be maintained within the manhole when the flow line elevations of the sewers are at or within one pipe diameter of the smaller pipe; or
 - (2) The flow line elevation of the entering pipe is above the crown of the primary sewer and clearance can be provided between the sewers.

- d. Place manholes at the terminal (most upstream) end of all public sewer lines. Clean-outs will not be utilized except at the end of each service lead.
- e. Existing manholes located within the city limit shall be identified by the alphanumeric system established by the Department. Refer to Department's "GIMS" map's "Wastewater Manholes" data layer for the 8-digit ID #s. If the manhole has no ID #, use the manhole's "Feature ID #" from the "Identify" query-generated pop-up database box.
- f. Criteria for Connections to and Utilization of Manholes:
 - (1) Connections between public sewers at the manhole shall adhere to the following criteria when possible:
 - (a) The elevation of the crown of the discharging sewer shall either match the elevation of the crown of the receiving sewer or be approved as a special case by the City.
 - (b) A standard outside drop connection as shown in City of Houston Standard Details is required when the difference in elevation between discharging sewer flow line and receiving sewer flow line is greater than 24-inches.
 - (2) The routing of a service connection directly to an existing manhole will be allowed only if:
 - (a) The flow line elevation of the existing sanitary sewer is more than 10 feet below grade and there is no available stack and the lot to be so connected is a single-family, owner-occupied, single lot residence connection to an existing manhole; or
 - (b) The lot to be so connected is a single-family, single lot connecting to a manhole in a cul-de-sac.
 - (c) Satisfies discharge requirements of service leads requiring manholes (see Paragraph 8.04.D.3).
 - (3) When routing an approved service lead to a manhole the wall penetration shall not be greater than 10-inches in diameter and shall be sealed using approved water stop and grout, see Paragraph 8.04.J.2.f.(2).
 - (4) When routing an approved service lead to an existing manhole with invert elevation more than 24-inches lower, the connections shall utilize an outside drop and shall adhere to the following criteria, see Paragraph 8.04.J.2.f.(3):

- (a) The manhole wall penetration shall not be greater than 10-inches in diameter,
 - (b) The outside drop shall be a minimum of 6-inches in diameter and shall be constructed of SDR 26 PVC pipe (ASTM D 3034),
 - (c) The outside drop shall be located 45-degrees from the upstream side of the sewer line,
 - (d) Usage of an internal drop will be reviewed on a case-by-case basis. A minimum of 48-inches of clear space shall be maintained inside the manhole between the drop and the opposing manhole wall. The drop pipe shall be firmly and frequently affixed to the manhole wall utilizing stainless steel bands and anchor bolts. All existing coatings shall be repaired per manufacturers recommendations upon completion,
 - (e) An internal drop shall terminate with a 45-degree bend. The 45-degree bend shall not extend below the top-of-pipe elevation of receiving sanitary sewer, and
 - (f) The wall penetration shall be sealed using an approved water stop and grout.
- (5) When the line is more than 20-feet below grade or the line is greater than 36-inch in diameter a site-specific design is required.
3. Benches and Inverts: The bottom of the manhole shall be provided with a “U” shaped channel that is a smooth continuation of the inlet and outlet pipes. The depth of the “U” shaped channel shall be at least equal to the largest pipe diameter. In manholes with pipes of different sizes, the tops of the pipes shall be placed at the same elevation and flow channels in the invert sloped on an even slope from pipe to pipe. The bench provided above the channel shall be smooth and uniformly sloped at a minimum of 1-inch per foot to a maximum of 1.5-inches per foot, from the wall to the top of the invert channel.
4. Large manholes: All manholes connecting pipes larger than 36-inch and junction boxes shall have the lower corners filleted to prevent solids deposition.

K. Lift Stations

1. Lift station design shall comply with the City of Houston Engineering Design Manual for Submersible Lift Stations and Design Guideline Drawings for Submersible Lift Stations, latest revision. The designer shall submit a Final Design Submittal Checklist (available from the City), signed and sealed by the Design Engineer, to ensure that the lift station is designed in compliance with the requirements of

applicable codes and regulations. Include a copy of the Engineering Design Report satisfying TCEQ criteria.

L. Metro Solutions – Guided Rapid Transit

1. Location of Sanitary Sewer Lines

- a. Sanitary sewer lines crossing under tracks shall be in steel casing, with minimum pipe size of 10-inches.
- b. Sanitary service lines (building connections) shall not cross under tracks.
- c. Extend the sanitary sewer stub for a minimum of "depth of sanitary sewer cover + 5 feet" beyond pavement limits.
- d. Relocate existing sanitary sewer lines for a minimum of 15 feet from centerline of the nearest proposed track.
- e. SDR 35 PVC pipe is not allowed.
- f. Minimum cover of the pipe shall be determined by the Guided Rapid Transit Load Distribution calculations, use the greater of the calculated live or dead loads.

8.05 UNSERVED SITES REQUIRING ON-SITE SEWAGE FACILITIES (OSSF) (SEPTIC TANKS)

- A. Engineer shall conform to applicable County criteria.

8.06 SUBMITTALS

A. Preliminary Design - Submit the following for review and comment:

1. Copies of any documents, which show approval or exceptions to the City design criteria.
2. Design calculations for line sizes and grades.
3. Contour map for overall area.
4. Plan-and-profile sheets showing proposed improvements (City projects only).
5. Geotechnical soils report for the project (City projects only).

B. Final Design - Submit the following for approval:

1. Final documents of the above plus plan-and-profile sheets and geotechnical soils reports for non-City projects.

2. Review prints.
3. Original drawings.
4. Complete copy of project specifications.
5. A final engineering design report shall be developed following the latest edition of TCEQ Chapter 217 and submitted to the City for each project. This report shall bear the signed and dated seal of a Professional Engineer registered in the State of Texas who is responsible for the design.

8.07 QUALITY ASSURANCE

- A. Prepare calculations and construction drawings under the supervision of a Professional Engineer trained and licensed under the disciplines required by the drawings. The final construction drawings must be sealed, signed, and dated by the Professional Engineer responsible for the development of the drawings.

8.08 RESEARCH REQUIREMENTS

- A. Discuss project concepts outlining proposed features and usage with City of Houston, Department of Public Works and Engineering.
- B. Research existing utility and Right-Of-Way information.
- C. Verify that no restrictions exist that will deny approval of the project concept.

8.09 DESIGN ANALYSIS

- A. A calculation of design flows for the complete development project.
- B. Calculations for design of any treatment plant required for the development.
- C. Calculations for effect of the 25-year storm outfall from any proposed treatment plant.

8.10 DRAWINGS

- A. Drawings shall include layout sheets with contours, plan-and-profile sheets, and detail sheets for special items and treatment plants.

END OF CHAPTER

City of Houston

Design Manual

Chapter 9

STORMWATER DESIGN REQUIREMENTS

Chapter 9

STORMWATER DESIGN REQUIREMENTS

9.01 CHAPTER INCLUDES

- A. Criteria for the design of storm drainage improvements.

9.02 DRAINAGE POLICY

- A. Design Requirements.

1. Drainage criteria administered by the City of Houston and complemented by Harris County and the Harris County Flood Control District (HCFCD) for newly designed areas provides protection from Structural Flooding from a 100-year storm event. This is accomplished through application of various drainage enhancements, such as storm sewers, roadside ditches, open channels, detention and overland (sheet) run-off. The combined system is intended to prevent Structural Flooding from extreme events up to a 100-year storm.
2. Recognizing that each site has unique differences that can enhance the opportunity to provide proper drainage, the intent of these criteria is to specify minimum requirements that can be modified provided that the objective for drainage standards is maintained. For projects which require a site specific approach and where unique engineering solutions will achieve drainage objective, a request for consideration of alternative standards (pipe flow, overland sheet flow, and detention storage) shall be submitted to the City of Houston Department of Public Works and Engineering, Office of the City Engineer (1st floor-611 Walker), for review and approval.

- B. Street Drainage: Street ponding of short duration is anticipated and designed to contribute to the overall drainage capability of the system. Storm sewers and roadside ditch conduits are designed as a balance of capacity and economics. These conduits are designed to convey less intense, more frequent rainfalls with the intent of allowing for traffic movement during these events. When rainfall events exceed the capacity of the storm sewer system, the additional run-off is intended to be stored or conveyed overland in a manner that reduces the threat of flooding to structures.

- C. Overland Run-off: Proposed New Development, Redevelopment, or In-fill Development shall not alter existing overland flow patterns and shall not increase or redirect existing Sheet Flow to adjacent private or public property. Sheet Flow from the developed property shall discharge only to the abutting public right-of-way. Where the existing Sheet Flow pattern is blocked by construction (i.e. raising the site elevation) of the Development, the Sheet Flow shall be re-routed within the developed property to return flow to original configuration or to the public right-of-way. Except under special circumstances dictated by natural drainage

patterns, no Sheet Flow from the developed property will be allowed to drain onto adjacent private property.

- D. Flood Control: The City of Houston is a participant in the National Flood Insurance Program (NFIP). The flood insurance program makes insurance available at low cost where the municipal entity implements measures that reduce the likelihood of Structural Flooding. The design criteria in this chapter are provided to support the NFIP. All development shall comply with Chapter 19, FLOOD-PRONE AREAS, of the Code of Ordinances if located within the City limits.
- E. Relationship to the Platting Process: Approval of storm drainage is a part of the review process for planning and platting of a New Development. Review and approval of plats is conducted by the Department of Planning and Development. Review of storm drainage is conducted by the Department of Public Works and Engineering (PWE).
- F. Development in Areas that have Deficient Drainage Systems: The City will consider joint project funding with a private entity for construction of drainage systems that improve existing drainage infrastructure. The City's first priority will be to fund those projects included in the Capital Improvement Plan (CIP). Where feasible, City funding will be leveraged with other funding sources including private entities, civic organizations, and other public agencies (Harris County, HCFCD, Corps of Engineers, Housing and Community Development, and other funding sources). For drainage systems that have been identified as deficient and are not scheduled to receive funding in the current CIP, the City will consider authorizing improvements performed by the private entity that comply with the City's objectives.
- G. The criteria in this Chapter apply to all projects located in the City limits and to expanding utility districts and new utility districts located in the City's Extraterritorial Jurisdiction (ETJ). If the criteria conflicts with Harris County, HCFCD, Fort Bend County, Montgomery County or other jurisdictions the most restrictive criteria shall govern.

9.03 REFERENCES

- A. Refer to the list of references in Chapter 1, General Requirements.
- B. National Weather Service Documents
 1. TP-40 Rainfall Frequency Atlas of the United States.
 2. Hydro-35; 5-to-60-Minute Precipitation Duration for the Eastern and Central United States.
- C. Hydraulic Engineering Circular No. 22, (HEC-22) Second Edition, "Urban Drainage Design Manual", Federal Highway Administration (FHWA).

- D. ASCE Manual and Reports of Engineering Practice No. 77, Design and Construction of Urban
- E. HouStorm – The City of Houston’s version of The Texas Department of Transportation’s (TxDOT) WinStorm software.
- F. HCFCFCD Policy, Criteria, and Procedure Manual (HCFCFCD Criteria Manual).

9.04 DEFINITIONS

- A. Conduit – Any open or closed device for conveying flowing water.
- B. Continuity Equation:
$$Q = VA$$

Where: Q = discharge (cfs or cms)
V = velocity (ft/sec or m/sec)
A = cross sectional area of Conduit (square feet or square meters)
- C. Design Storm Event – Rainfall intensity upon which the drainage facility will be sized.
- D. Development – The term includes New Development, Redevelopment, and In-fill Development.
 - 1. In-fill Development – Development of open tracts of land in areas where the storm drainage infrastructure is already in place and takes advantage of the existing infrastructure as a drainage outlet.
 - 2. New Development – Development of open tracts of land in areas where the storm drainage infrastructure has not been constructed and a drainage outlet must be extended to a channel under the jurisdiction of the HCFCFCD.
 - 3. Redevelopment – A change in land use that alters the impervious cover from one type of Development to either the same type or another type, and takes advantage of the existing infrastructure in place as a drainage outlet.
- E. Drainage Area Map – Area map of watershed which is subdivided to show each area served by each subsystem.
- F. FEMA – Federal Emergency Management Agency.
- G. HCFCFCD – Harris County Flood Control District.
- H. HouStorm – The City of Houston’s version of TxDOT’s WinStorm software. The program is available from the City or at www.swmp.org.

- I. Hydraulic Grade Line - A line representing the pressure head (water surface elevation) available at any given point within the drainage system.
- J. Manning's Equation:

$$V = (K/n)R^{2/3} S_f^{1/2}$$
 Where: K = 1.49 for English units,
 1.00 for metric units
 V = velocity (ft./sec or m/sec)
 R = hydraulic radius (ft. or m) (area/wetted perimeter)
 S_f = friction slope (headloss/length)
 N = 0.012 for corrugated profile-wall polyethylene pipe
 0.013 for concrete pipes,
 0.015 for concrete boxes,
 0.024 for CMP pipes
- K. Rainfall Frequency - Probability of a rainfall event of defined characteristics occurring in any given year at a given location. Information on Rainfall Frequency is published by the National Weather Service. For the purpose of storm drainage design, the following frequencies are applicable:
1. 2-year frequency - a rainfall intensity having a 50 percent probability of occurrence in any given year, that occurs on the average every 2 years over a long period of time.
 2. 3-year frequency - a rainfall intensity having a 33 percent probability of occurrence in any given year, that occurs on the average every 3 years over a long period of time.
 3. 5-year frequency - a rainfall intensity having a 20 percent probability of occurrence in any given year, that occurs on the average every 5 years over a long period of time.
 4. 10-year frequency - a rainfall intensity having a 10 percent probability of occurrence in any given year, that occurs on the average every 10 years over a long period of time.
 5. 25-year frequency - a rainfall intensity having a 4 percent probability of occurrence in any given year, that occurs on the average every 25 years over a long period of time.
 6. 100-year frequency - a rainfall intensity having a 1 percent probability of occurrence in any given year, that occurs on the average every 100 years over a long period of time.
- L. Rational Formula - A method for calculating the peak run-off for a storm drain system using the following equation for run-off:

$$Q = I \times (CA)$$
 Where: C = watershed coefficient
 A = area (acres)

I = rainfall intensity (inches per hour)

- M. Sheet Flow - Overland storm run-off that is not conveyed in a defined Conduit and is typically in excess of the capacity of the existing Conduit system.
- N. Storm Sewer Junction Box – Precast or cast-in-place concrete, square or rectangular structure used to merge upstream pipes, accommodate changes in pipe size or direction, or provide service access to the storm sewer system by the addition of a circular manhole structure to the top of the junction box. A junction box shall have a minimum: wall thickness of 6-in, interior horizontal width of 48-in, and 3-in clearance between the outside diameter of the largest intersecting pipe and the interior face of the box. Signed and sealed structural calculations shall be provided for a junction box whose interior horizontal width and exterior vertical height is greater than 96-in.
- O. Structural Flooding – The water surface elevation from the storm event exceeds the top of slab elevation of the building (for pier and beam construction the top of first floor elevation), resulting in water entering the structure.

9.05 DESIGN REQUIREMENTS

- A. Design of drainage facilities shall meet requirements of the City of Houston Standard Specifications and Standard Details. HouStorm shall be used to perform design analysis and design of storm drainage systems as follows:
 - 1. City of Houston CIP Projects – Required. In conjunction with design analysis using HouStorm, designs shall comply with guidelines provided in Technical Paper No. 100 (TP-100), Storm Sewer Design Applications for the City of Houston, Texas, Capital Improvement Plan Projects, February 2005, or the latest published date.
 - 2. Private Projects within City Limits which include City funding participation – Required.
 - 3. 100% Privately-funded Project located in City Limits – HouStorm preferred but alternative equivalent analysis procedures will be accepted.
 - 4. Projects in New or Expanding Utility Districts located in City’s ETJ - HouStorm preferred but alternative equivalent analysis procedures will be accepted.
- B. Determination of Run-off.
 - 1. Design Storm Events.
 - a. Rainfall Duration:
 - (1) For design purposes, the rainfall duration for drainage areas less than

- (2) Alternatively, the run-off coefficient C in the rational method formula can be calculated from the equation:

$$C = 0.6Ia + 0.2$$

Where: C = watershed coefficient

Ia = impervious area/total area

- (3) If the alternate form is to be submitted, the calculation of C shall be provided as part of the drainage calculations.

b. Determination of Time of Concentration.

Time of concentration can be calculated from the following formula:

$$TC = 10A^{0.1761} + 15$$

Where: TC = time of concentration (minutes)

A = subarea (acres)

c. Sample Calculation Forms.

- (1) Figure 9.2, City of Houston Storm Sewer Calculation Form, is a sample calculation form for storm sewer systems.
- (2) Figure 9.3, City of Houston Roadside Ditch Worksheet, is a sample calculation form for roadside ditch systems.

C. Design of Storm Sewers.

1. Design Frequency.

- a. New Development: The Design Storm Event for sizing storm sewers in newly developed areas will be a 2-year rainfall.
- b. Redevelopment or In-fill Development: The existing storm drain (sewer, ditch) will be evaluated using a 2-year design storm, assuming no development takes place. The storm drain will then be evaluated for the 2-year design event with the Development in place.
- (1) If the proposed Redevelopment has a lower or equal impervious cover, no modifications to the existing storm drain are required.
- (2) If the proposed Development results in the hydraulic gradient of the existing storm drain below the gutter line, no improvements to the existing storm drain are required. Detention shall comply with Paragraph 9.05.H. Flow discharged to the storm drain shall be in compliance with Paragraph 9.05.H.4.b.
- (3) If the analysis of the existing conditions finds that the existing storm drain is deficient (i.e. the hydraulic grade line is above the gutter line), the applicant should check with the City to see if a CIP project is proposed that will require a capital contribution. If a CIP project is not proposed for the subject system, then on-site detention will be required in accordance with Paragraph 9.05.H. Flow discharged to the storm

drain shall be in compliance with Paragraph 9.05.H.4.b.

- c. City Projects (CIP): Proposed City capital improvements may indicate a larger diameter storm sewer is planned in the area proposed for drainage improvements. The Engineering and Construction Division of PWE has information on proposed improvements and should be consulted for impact on New Development.
 - d. Private Drainage Systems: Storm sewers for private drainage systems should conform to the City of Houston Uniform Building Code for development within the City limits.
2. Velocity Considerations.
- a. Storm sewers should be constructed to flow in subcritical hydraulic conditions if possible.
 - b. Minimum velocities should not be less than 3 feet per second with the pipe flowing full, under the design conditions.
 - c. Maximum velocities should not exceed 8 feet per second without use of energy dissipation downstream.
 - d. Maximum velocities should not exceed 12 feet per second.
3. Pipe Sizes and Placement.
- a. Use storm sewer and inlet leads with at least 24-inch inside diameter or equivalent cross section. Box culverts shall be at least 2 feet by 2 feet. Closed Conduits; circular, elliptical, or box, shall be selected based on hydraulic principals and economy of size and shape.
 - b. Larger pipes upstream should not flow into smaller pipes downstream unless construction constraints prohibit the use of a larger pipe downstream, or the improvements are outfalling into an existing system, or the upstream system is intended for use in detention.
 - c. Match crowns of pipe at any size change unless severe depth constraints prohibit.
 - d. Locate storm sewers in public street rights-of-way or in approved easements. Back lot easements are discouraged and will require a variance from the City design standards.
 - e. Follow the alignment of the right-of-way or easement when designing cast in

- place concrete storm sewers.
 - f. A straight line shall be used for inlet leads and storm sewers.
 - g. Center culverts in side lot storm sewer easements.
4. Starting Water Surface and Hydraulic Gradient.
- a. The hydraulic gradient shall be calculated assuming the top of the outfall pipe as the starting water surface.
 - b. At drops in pipe invert, should the upstream pipe be higher than the Hydraulic Grade Line, then the Hydraulic Grade Line shall be recalculated assuming the starting water surface to be at the top of pipe at that point.
 - c. For the Design Storm, the hydraulic gradient shall at all times be below the gutter line for all newly developed areas.
5. Manhole Locations.
- a. Use manholes at the following locations:
 - (1) Size or cross section changes.
 - (2) Inlet lead and Conduit intersections.
 - (3) Changes in pipe grade.
 - (4) Street intersections.
 - (5) A maximum spacing of 700 feet measured along the Conduit run.
 - b. Use manholes for existing monolithic-concrete storm sewers at the same locations as above except for intersections of inlet leads unless a manhole is needed to provide maintenance access at those intersections.
 - c. Do not place manholes in driveways or in the street in front of or immediately adjacent to a driveway.
6. Inlets.
- a. Locate inlets at low points in the gutter.
 - b. Valley gutters across intersections are not permitted.
 - c. Inlet spacing is a function of gutter slope. The minimum gutter slope shall comply with Chapter 10, Street Paving Design Requirements. For minimum gutter slopes, the maximum spacing of inlets shall result from a gutter run of 700 feet from high point in pavement or the adjacent inlet on a continuously graded street section, with a maximum of 1400 feet of

pavement draining towards any one inlet location.

- (1) Residential Development: Maximum spacing of inlets shall result from a gutter run of 700 feet from high point in pavement to the adjacent inlet on a continuously graded street section, with a maximum of 1400 feet of pavement draining towards any one inlet location.
- (2) Commercial Development: Maximum spacing of inlets shall result from a gutter run of 400 feet from high point in pavement to the adjacent inlet on a continuously graded street section with a maximum of 600 feet of pavement draining towards any one inlet location.

d. Use only City of Houston standard inlets.

Table 9.1
STANDARD STORM SEWER INLETS

INLET	APPLICATION	CAPACITY	DWG. NOS.
Type A	Parking Lots/Small Areas	2.5 cfs	02632-01
Type B-B	Residential/Commercial	5.0 cfs	02632-04
Type C	Residential/Commercial	5.0 cfs	02632-06
Type C-1	Commercial	10.0 cfs	02632-06
Type C-2	Commercial	15.0 cfs	02632-06
Type C-2A	Commercial	20.0 cfs	02632-06
Type D	Parking Lots	2.0 cfs	02632-07
Type D-1	Small Areas	2.5 cfs	02632.08
Type E	Roadside ditches	20.0 cfs	02632-09,-10
Type H-2	Residential Commercial	5.0 cfs	02633-01,-02

- e. Do not use beehive grate inlets or other specialty inlets.
- f. Do not use grate top inlets in unlined roadside ditch.
- g. Do not place inlets in the circular portion of cul-de-sac streets unless justification based on special conditions can be provided.
- h. Place inlets at the end of proposed pavement, if drainage will enter or leave pavement.
- i. Do not locate inlets adjacent to esplanade openings.
- j. For new residential development, locate inlets at the center of lots and drainage system with lot site layout such that inlets are not located within

the driveway between the radius end points as defined by the driveway radius intersection with the curb or edge of pavement.

- k. Place inlets on side streets intersecting major streets, unless justification based on special conditions can be provided.
- l. For private development with internal site drainage, only one connection is permitted to any one inlet, and that connection (lead) shall be made to the back of the inlet. Connection shall not be made to the front face and to the short sides of the inlet unless approved by the City. Design the connection not to exceed the pipe capacity minus either the capacity listed in Table 9.1, Standard Storm Sewer Inlets, or calculated inlet inflow.
- m. For all new construction, convey public or private alleyway drainage to an inlet prior to entering the public street drainage system.

D. Consideration of Overland Flow for the Extreme Event.

- 1. Design Frequency: Design frequency for consideration of overland flow shall consider extreme storm events (100-year storm) which exceed the capacity of the underground storm sewer system resulting in ponding and overland flow from the Development to the primary outlet.
- 2. Design Analysis: An overland flow analysis of the proposed drainage system shall be prepared by the design engineer. The design engineer shall submit supporting calculations, exhibits, and drawings.
 - a. Three analysis methods as presented in Technical Paper No. 101, Simplified 100-year Event Analyses of Storm Sewers and Resultant Water Surface Elevations for Improvement Projects in the City of Houston, Harris County, Texas Region will be acceptable to the City.
 - (1) Method 1: Hydraulic Grade Line (HGL) Analysis A simplified approach to analyze and control the 100-year water surface elevation (WSEL) can be achieved by designing the storm sewer system for the 2-year frequency storm event; imposing a 100-year frequency storm event on the proposed design; calculating the hydraulic grade for the 100-year frequency event for the proposed design; and adjusting the position of the HGL to not exceed the desired water surface elevation by increasing the size of the proposed storm sewer for selective reaches.
 - (2) Method 2: $Q_t = Q_o + Q_c$
where Q_t is the total flow conveyed,
 Q_o is the overland flow component, and
 Q_c is the calculated flow in the conduit for the 2-year design event.

The overland flow component (Q_o) is computed by applying Manning's Equation to calculate the flow across the critical street cross-section along the right of way. This method accounts for flow in the storm sewer and overland flow across the street crest, but does not account for street ponding or storage.

- (3) Method 3: $Q_t = Q_o + Q_c + \Delta S/T$
where Q_t , Q_o , and Q_c are as defined above, and $\Delta S/T$ is the change in storage volume relative to time provided in the streets and adjacent area upstream of the point of interest being analyzed. This method uses a volumetric calculation based on a 100-year frequency storm event with a duration of 3-hours for developments less than 200 acre and 6-hours duration for developments over 200 acres. The Soil Conservation Service, TR-20 method is used to set a peak triangular hydrograph shape. This method accounts for flow in the storm sewer, overland flow across the street crest, and storage within the street and adjacent area.

- b. Analysis using the U.S. Environmental Protection Agency's Storm Water Management Model (SWMM) will be acceptable to the City.
3. Relationship of Structures to Street: All structures shall be higher than the highest level of ponding anticipated resulting from the extreme event analysis.
4. The parameters stated below are independent measures that shall be evaluated for each project. The limiting parameter will depend on project-specific conditions, and the most restrictive condition (the lowest ponded water elevation) shall govern.
- a. Streets shall be designed so that consecutive high points in the street will provide for a gravity flow of drainage to the ultimate outlet.
- b. The maximum depth of ponding at high points shall be 6 inches above top of curb.
- c. The maximum depth of ponding at low points shall be 18 inches above top of curb.
- d. Provide a minimum 20-foot easement to accommodate sheet flow that is routed between lots or across reserve tracts in accordance with Section 5.07.C of the City of Infrastructure Design Manual. Fence lines and other improvements shall not be constructed on or across dedicated drainage easements.
- e. A drawing(s) shall be provided to delineate extreme event flow direction through a proposed Development and how this flow is discharged to the primary drainage outlet. The drawing(s) shall show a profile of the

roadway (or overland flow path) from the upper reach of the drainage area to the primary drainage outlet. The drawing(s) shall be exaggerated vertical scale and shall include roadway profile at the gutter, ground profile at the right-of-way, and the hydraulic gradient for the extreme event (100-year storm), or an alternative equivalent drawing accepted by the City.

- f. In areas where ponding occurs and no Sheet Flow path exists, then a calculation shall be provided showing that run-off from the 100-year event can be conveyed and remain in compliance with the other requirements of this paragraph.
 - g. Maximum Ponding Elevation
 - (1) The maximum ponding elevation for the 100-year event at any point along the street shall not be higher than the natural ground elevation at the right-of-way line. Where existing topographic conditions, project location within a special flood hazard area, and/or other site conditions preclude achieving this objective, the City will waive this requirement upon submittal of documentation and analysis prepared, signed, and sealed by a professional engineer, registered in the State of Texas. Analysis shall demonstrate that structural flooding will not occur.
 - (2) For new subdivisions the ponding elevations shall be no higher than 12 inches below the proposed finished slab elevations, or, if the proposed finished slab elevations are less than 12 inches above the ground elevations at the right-of-way, the ponding elevations shall be no higher than the ground elevations at the right-of-way.
5. Evacuation Routes and Emergency Service Routes. This standard applies to routes designated by the PWE for emergency evacuation and for routes where access by the emergency service vehicles is a public safety need. Ponding of surface runoff is not allowed in the highest travel lane (each direction) for the 100-year event. Exceptions to this standard based on technical infeasibility or cost limitations will require approval of the Director, Public Works and Engineering Department, or his designated representative. This standard may be modified or exempted for locations in the 100-year floodplain.
- E. Design of Open Channels.
- 1. Design Frequency.
 - a. Open channels shall be designed according to methods described in the HCFCF Criteria Manual.

- b. Design standards for channel construction shall follow the requirements specified in the HCFCFCD Criteria Manual.
 - c. Design standards for outfalls into channels shall conform to those in the HCFCFCD Criteria Manual.
 2. Determination of Water Surface Elevation.
 - a. Water surface elevations shall be calculated using Manning's Equation and the Continuity Equation.
 - b. For the Design Storm Event, the water surface shall be calculated to remain within banks.
 3. Design of Culverts.
 - a. Head losses in culverts shall conform to TxDOT Hydraulics Manual, Chapter 4, Culverts.
 - b. Corrugated metal pipe will only be approved for railroad crossings.
- F. Design of Roadside Ditches.
 1. Design Frequency.
 - a. Roadside ditch design is permissible only for single family residential lots or commercial areas equal to or larger than 0.5 acres.
 - b. The Design Storm Event for the roadside ditches shall be a minimum of 2-year rainfall.
 - c. Design capacity for a roadside ditch shall be to a minimum of 0.5 feet below the edge of pavement or 0.5 feet below the natural ground at right-of-way line, whichever is lower.
 - d. The design must include an extreme event analysis to indicate that structures will not be flooded, and maximum ponding elevation for the extreme event complies with Paragraph 9.05.D.3.
 2. Velocity Considerations.
 - a. For grass-lined sections, the maximum design velocity shall be 3.0 feet per second during the design event.
 - b. A grass-lined or unimproved roadside ditch shall have side slopes no

steeper than three horizontal to one vertical (3:1), or as soil conditions will permit.

- c. Minimum grades for roadside ditches shall be 0.1-foot per 100 feet.
- d. Calculation of velocity will use a Manning's roughness coefficient (n) of 0.045 for earthen sections and 0.025 for ditches with paved inverts.
- e. Use erosion control methods acceptable to the City when design velocities are expected to be greater than 3 feet per second.

3. Culverts.

- a. Culverts will be placed at all driveway and roadway crossings, and other locations where appropriate.
- b. Culverts will be designed assuming inlet control.
- c. Roadside culverts are to be sized based on drainage area. The minimum culvert size shall be 24 inches unless the option for multiple smaller size culverts is approved by the City Engineer. When requested, calculations shall be provided for review. Culvert shall be placed to be a minimum of 4 inches and no more than 8 inches below the ditch flow line. Existing roadside ditch on both sides of the proposed culvert shall be regraded for positive drainage to the nearest intersection or up to 500 linear feet whichever is smaller. In the ETJ, the Regulations for Harris, County, Texas for the Construction of Driveways and/or Culverts on County Easements and Rights-of-Way shall govern.
- d. Cross open channels with roadside culverts no smaller than 24 inches inside diameter or equivalent. The size of culvert used shall not create a head loss of 0.20 feet greater than the normal water surface profile without the culvert.
- e. Stormwater discharging from a ditch into a storm sewer system must be received by use of an appropriate structure (i.e., stubs with ring grates or Type E inlets).

4. Invert Protection.

- a. Ditch invert protection shall be used when velocities exceed 3 feet per second.
- b. Ditch invert protection will be used at the upstream and downstream ends of all culverts.

5. Depth and Size Limitations.
 - a. Maximum depth shall not exceed 4 feet from adjacent edge of pavement.
 - b. Roadside ditch bottoms shall be at least 2 feet wide, unless design analysis will support a narrower width.
 - c. Ditches in adjoining and parallel easements shall have top of bank not less than 2 feet from the outside easement line.

- G. Design of Outfalls: Outfall design shall conform to HCFCD Standards.

- H. Stormwater Detention.
 1. The intention of stormwater detention is to mitigate the effect of the New Development, Redevelopment, or In-fill Development on an existing drainage system. Stormwater detention volume is based on increased impervious cover and is calculated at the minimum rates set forth in Paragraph 9.05.H.3.

 2. Application of Detention.
 - a. The use of on-site detention is required for all Developments within the City and for new or expanding utility districts within the City's ETJ. Detention will not required if the City has developed detention capacity for a drainage watershed, and/or infrastructure improvements, to serve the drainage watershed in compliance with the requirements of this Chapter. Under these conditions, the City will consider a funding contribution in lieu of on-site detention volume constructed by the owner.

 - b. If New Development, Redevelopment, or In-fill Development drains directly into a channel maintained by HCFCD, then HCFCD criteria prevails. If New Development, Redevelopment or In-fill Development drains directly to a roadside ditch, drainage ditch or storm sewer maintained by Harris County then the criteria in Regulations of Harris County, Texas for the Approval and Acceptance of Infrastructure governs; however, for all cases of multiple regulatory jurisdiction, Paragraph 9.02.G takes precedence.

 - c. If the drainage system outfalls directly into a channel maintained by HCFCD, and the requirements of HCFCD include payment of an impact fee, then no further impact fee will be required by the City.

 - d. If Redevelopment occurs without increasing the overall impervious character of the site, then no detention will be required by the City.

- e. A waiver of detention requirements may be requested if the following conditions are satisfied:
 - (1) Development is located in an area determined by the City to not need detention due to the geographic location in the watershed, the Development's proximity to regional facilities, or the capacity of the receiving outfall facilities. Such conclusion by the City shall be supported by submittal of a Hydraulic Report as described in Paragraph 9.05.H.2.e(2).
 - (2) Hydraulic Report: Submit a hydraulic analysis prepared, signed, and sealed by a professional engineer, registered in the state of Texas, to demonstrate compliance with the conditions stated in this Chapter. The hydraulic analysis shall consider (1) the current developed condition of the watershed of the stormwater conveyance system, and (2) the fully developed condition of the watershed. The probable land use for the fully developed condition will be determined by the design engineer for review and approval by the City. The hydraulic analysis shall demonstrate no negative impact to upstream or downstream conditions and shall demonstrate that a positive impact will be achieved (reduced flood crest due to the exemption).

- 3. Calculation of Detention Volume.
 - a. Detention volume for Development areas is calculated on the basis of the amount of area of increased impervious cover. Impervious cover includes all structures, driveways, patios, sidewalks, etc.

 - b. Single family residential (SFR) lots of 15,000 square feet in area or less: SFR Lots are exempt from detention if proposed impervious cover is less than or equal to 75.0 %. Detention volume of 0.20 acre feet per acre required for impervious cover over 75%.

Existing SFR lots of 15,000 square feet or less may be further subdivided and exempt from detention provided the proposed impervious cover remains less than or equal to 75.0%

 - c. Areas less than 1 acre: Detention will be required at a rate of 0.20 acre feet per acre of increased impervious cover. The subdividing of larger tracts into smaller tracts of 1.0 acre and less will require the detention volume of 0.5 acre-feet per acre of increased impervious cover.

 - d. Areas between 1 acre and 50 acres: Detention will be required at a rate of 0.50 acre-feet per acre of increased impervious cover.

- e. Areas greater than 50 acres: Reference HCFCFCD Criteria Manual.
 - f. Private parking areas, private streets, and private storm sewers may be used for detention provided the maximum depth of ponding does not exceed 9 inches directly over the inlet, and paved parking areas are provided with signage stating that the area is subject to flooding during rainfall events.
 - g. Private transport truck only parking may be used for detention provided the maximum depth of flooding does not exceed 15 inches directly above the inlet and signage is provided stating that the area is subject to flooding during rainfall events.
4. Calculation of Outlet Size.
- a. Detention pond discharge pipe into an existing storm sewer line or existing City of Houston ditch:
 - (1) Maximum pool elevation at or below the design hydraulic grade at the drainage system outfall - The discharge line shall be sized for the Design Storm with the discharge pipe flowing full. The pond will float on the drainage system to provide maximum benefit.
 - (2) Maximum pool elevation at or above the hydraulic grade at the drainage system outfall - Provide a reducer or restrictor pipe to be constructed inside the discharge line. The discharge line shall be sized for the Design Storm with the discharge pipe flowing full.
 - b. Reducer or Restrictor Pipes shall be sized as follows:
 - (1) Allowable Discharge Rate – Use the lowest of the discharge rates described below:
 - (a) Restrictor pipes will provide a combination of low level and high level controlled release from the detention basin. The low level restrictor pipe (primary orifice) shall be sized to provide a release rate of 0.5 CFS/acre when the detention basin water depth reaches 25% of full basin depth. The low level restrictor pipe (primary orifice) shall be located at the bottom of the basin to provide complete drainage of the pond. The high level restrictor pipe (secondary orifice) shall be sized to provide a combined release rate (from the primary orifice and secondary orifice) of 2.0 CFS/acre at full basin depth. The high level restrictor (secondary orifice) shall begin releasing flow when detention basin water depth reaches 75% of full basin depth. The combined rate of 2.0 CFS/acre is the approximate

discharge from an undeveloped tract for the 100-year storm.

- (b) Flow discharged to the storm drain shall not exceed the proportional amount of pipe capacity allocated to the Development. The proportional amount of pipe capacity allocated to the Development shall be determined by the ratio of the area (acres) of the Development (in storm drain watershed) divided by the total drainage area (acres) of the storm drain multiplied by the capacity of the storm drain.

- (2) Use the following equations to calculate the required outflow orifice:

$$Q = CA \sqrt{2g} \sqrt{h}$$

$$D = Q^{1/2} / (2.25 h^{1/4})$$

Where:

- Q = outflow discharge (cfs)
- C = coefficient of discharge
 - = 0.8 for short segment of pipe
 - = 0.6 for opening in plates, standpipes, or concrete walls
- A = orifice area (square feet)
- g = gravitational factor (32.2)
- h = head, water surface differential (feet)
- D = orifice diameter (feet)

- (3) Restrictor shall be either of the required diameter or of the equivalent cross-sectional area. The orifice diameter D shall be a minimum of 0.5 feet.

- c. In addition to a pipe outlet, the detention basin shall be provided with a gravity spillway that will protect structures from flooding should the detention basin be overtopped.

5. Ownership and Easements.

- a. Private Facilities:

- (1) Pump discharges into a roadside ditch requires the submittal of pump specifications on the design drawings.
- (2) The City reserves the right to prohibit the use of pump discharges where their use may aggravate flooding in the public right-of-way.
- (3) Responsibility for maintenance of the detention facility must be indicated by letter submitted to the City as part of the design review.
- (4) All private properties being served have drainage access to the pond. Dedicated easements may be required.
- (5) No public properties drain into the detention area.

- (6) A private maintenance agreement is provided when multiple tracts are being served.

b. Public Facilities:

- (1) Facilities will only be accepted for maintenance by the City within the City limits in cases where public drainage is being provided.
- (2) The City requires a maintenance work area of 30-foot width surrounding the extent of the detention area. Public rights-of-way or permanent access easements may be included as a portion of this 30-foot width.
- (3) A dedication of easement shall be provided by plat or by separate instrument.
- (4) Proper dedication of public access to the detention pond must be shown on the plat or by separate instrument. This includes permanent access easements with overlapping public utility easements.
- (5) Backslope drainage systems are required where the natural ground slopes towards the drainage basin. A basin that is within 30 feet of a parking lot or roadway with berms that drain away from the basin does not require a backslope swale. Comply with criteria provided in HCFCDC Criteria Manual.

9.06 EASEMENT AND RIGHTS-OF-WAY

- A. Storm sewer easement and right-of-way requirements are described in Chapter 5 Easement Requirements.

9.07 SUBMITTALS

- A. Preliminary Submittals - Submittal, for review and comment, of one-line drawings is recommended and may be required as part of the platting process. One-line drawings should include:
 1. Approximate definition of lots and street patterns.
 2. The approximate drainage areas for each system.
 3. A definition of the proposed drainage system by single line.
 4. The proposed pipe diameters.
 5. Any proposed drainage easements.
 6. Floodplain information, including floodplain boundary, if any; FEMA map number, effective map date and zone.

- B. Final Design - Submit the following for approval:
1. Copies of any documents which show approval of exceptions to the City design criteria.
 2. Design calculations for time of concentration, storm line sizes and grades, and for detention facilities, if any.
 3. Design calculations for the Hydraulic Grade Line of each line or ditch, and for detention facilities, if any.
 4. Drainage Area Map with the following information:
 - a. Existing contour map.
 - b. Drainage area and sub-drainage area boundaries.
 - c. Drainage area (acres) and flow quantity (cfs) draining to each inlet and each pipe segment from manhole to manhole.
 - d. Extreme event (100-year) Sheet Flow direction.
 - e. Existing condition and developed condition Sheet Flow direction for the surrounding properties.
 5. Plan and profile sheets showing stormwater design (public facilities only).
 6. Projects located within a floodplain boundary or within a floodplain management area shall:
 - a. Show the floodplain boundary or floodplain area, as appropriate, on the one-line drawing or Drainage Area Map.
 - b. Comply with all applicable submittal requirements of Chapter 19, Code of Ordinances.
 7. Profile drawing of roadway (or overland flow path) with exaggerated vertical scale from the upper reach of drainage area to the primary drainage outlet. Show roadway profile at gutter, ground profile at the public right-of-way, and hydraulic gradient for the 100-year extreme event; or an alternative equivalent drawing accepted by the City.
 8. Calculation for proportional amount of pipe capacity allocated to the Development along with the drainage area map used for these calculations.

- C. Signature Stage - Submit the following for approval:
1. Review prints
 2. Original Drawings
 3. Stormwater detention maintenance agreement letters.
 4. Drainage Area Map with the following information:
 - a. Existing contour map.
 - b. Drainage area and sub-drainage area boundaries.
 - c. Drainage area (acres) and flow quantity (cfs) draining to each inlet and each pipe segment from manhole to manhole.
 - d. Extreme event (100-year) Sheet Flow direction.
 - e. Existing condition and developed condition Sheet Flow direction for the surrounding properties.
 5. Profile drawing as specified in Paragraph 9.07.B.7.

9.08 QUALITY ASSURANCE

- A. Prepare calculations and design drawings under the supervision of a Professional Engineer trained and licensed under the disciplines required by the project scope. The final design drawings and all design calculations must be sealed, signed, and dated by the Professional Engineer responsible for the development of the drawings.

9.09 DESIGN ANALYSIS

- A. Projects shall be tied to National Geodetic Survey (NGS) datum adjustment which matches the Federal Emergency Management Agency (FEMA) rate maps or the most current NGS datum which matches the FEMA rate maps. In the event GPS surveying is used to establish bench marks, at least two references to bench marks relating to the rate maps shall be identified. Equations may be used to translate other datum adjustments to the required adjustment.
- B. Drawing sets shall include a Drainage Area Map, which will contain calculations of flow by the rational method.
- C. Drainage systems for curb-and-gutter pavements shall be underground closed Conduits; individual residential lot drainage is exempt. Drainage systems for pavements without curb

and gutter shall be roadside open-ditch sections.

9.10 LOW IMPACT DEVELOPMENT

- A. Design requirements for Low Impact Development techniques are included in Chapter 13. Only three techniques may be considered to have impact on detention rates: Hard Roof, Green Roof, and Porous Pavement.

END OF CHAPTER

FIGURE 9.1
 City of Houston IDF Curves
 Intensity vs. Time of Concentration vs Rainfall Frequency
 Source: Hydro 35/TP-40

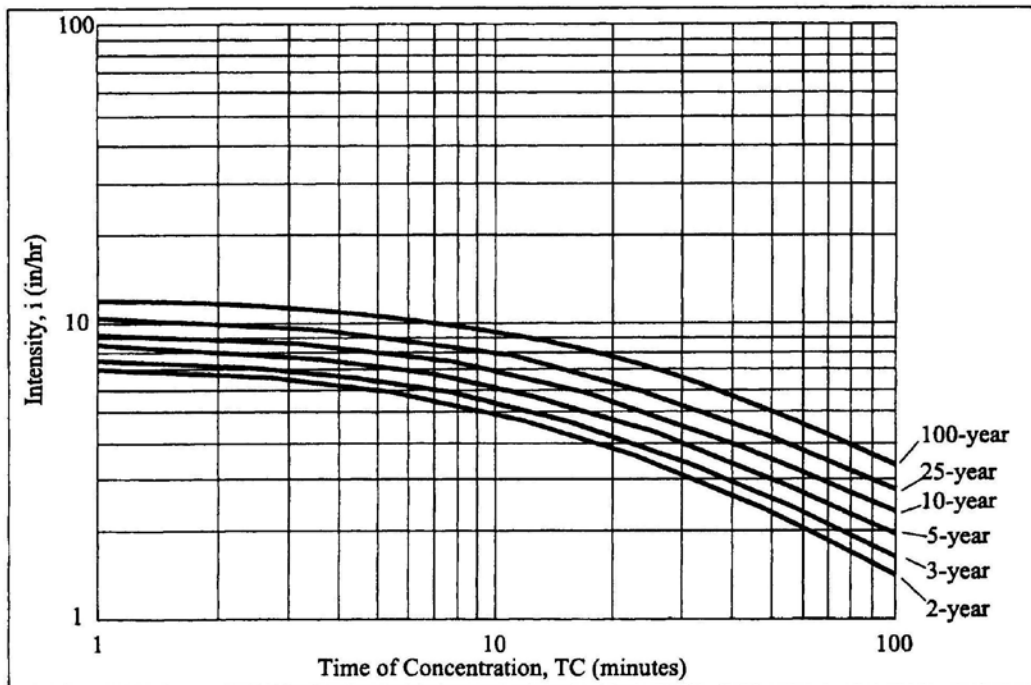

$$i = \frac{b}{(d+TC)^e}$$

$$TC = 10A^{0.1761} + 15$$

A = area in acres

Rainfall Frequency	<i>b</i>	<i>d</i>	<i>e</i>
2-year	75.01	16.2	0.8315
3-year	77.27	17.1	0.8075
5-year	84.14	17.8	0.7881
10-year	93.53	18.9	0.7742
25-year	115.9	21.2	0.7808
100-year	125.4	21.8	0.7500

City of Houston

Design Manual

Chapter 10

STREET PAVING DESIGN REQUIREMENTS

Chapter 10

STREET PAVING DESIGN REQUIREMENTS

10.01 CHAPTER INCLUDES

- A. Geometric design guidelines for streets, criteria for street paving, and standard paving notes for drawings.

10.02 REFERENCES

- A. Refer to the list of references in Chapter 1, General Requirements.
- B. AASHTO - American Association of State Highway and Transportation Officials
- C. ASTM - American Society for Testing and Materials
- D. ITE – Institute of Transportation Engineers
- E. TMUTCD – Texas Manual on Uniform Traffic Control Devices, Texas Department of Transportation.
- F. IBC - International Building Code
- G. MTFP - Major Thoroughfare Plan

10.03 DEFINITIONS

- A. CMP – City Mobility Plan
- B. Curb-and-gutter Sections - Full width concrete pavement with doweled on 6-inch curbs or monolithic curb-and-gutter sections for asphaltic concrete pavement. Curb-and-gutter sections require inlets and underground storm sewers.
- C. Geotechnical Engineer – A licensed Professional Engineer in the State of Texas who is practicing in the field of geotechnical engineering. Assignment of geotechnical or material testing by a geotechnical engineer shall be performed by a laboratory accredited by the American Association for Laboratory Accreditation (A2LA).
- D. HMAC - Hot-mix asphaltic concrete
- E. Intersection Sight Distance – Provides an unobstructed line of sight in each direction at intersections. The unobstructed line of sight allows for vehicles on side streets to observe approaching traffic on the main roadway and to safely enter an intersection from a side street.

The unobstructed line of sight allows for vehicles on the main roadway sufficient distance to observe vehicles entering from side streets.

- F. Local Streets – Provide access to individual single-family residential lots, provide entry and exit to the neighborhood, and provide connectivity to collectors and thoroughfares.
- G. Roadside Ditch Sections - Ditch sections adjacent to either full width reinforced concrete pavement or asphaltic concrete pavement. Roadside ditch sections do not require underground storm sewers; however, the ditch sections must be designed to accommodate storm runoff.
- H. Type 1 Permanent Access Easement - A permanent access easement at least 50 feet in width that is designed and constructed like a public street in accordance with the design manual and contains one or more public utilities in an unpaved portion of the easement. Refer to Chapter 42 of the Code of Ordinances No. 1999-262.
- I. Type 2 Permanent Access Easement - A permanent access easement at least 28 feet in width that is designed and constructed like a private street serving a development that has no public utilities other than a public water line connected only to one or more fire hydrants that provides no domestic water services. All private utilities within a Type 2 permanent access easement must be designed to public utility standards outlined in the Infrastructure Design Manual. Refer to Chapter 42 of the Code of Ordinances No. 1999-262.

10.04 HOT MIX ASPHALTIC CONCRETE (HMAC) PAVEMENT DESIGN REQUIREMENTS:

- A. HMAC Surface Minimum Thickness – Pavement design shall be prepared by a Professional Engineer based on current AASHTO design methodology (Guide for the Design of Pavement Structure). Minimum thickness shall be as shown on Standard Detail 02741-01.
- B. Flexible Base Minimum Thickness – Pavement design shall be prepared by a Professional Engineer based on current AASHTO design methodology (Guide for the Design of Pavement Structure). Minimum thickness shall be as shown on Standard Detail 02741-01.
- C. Subgrade Treatment
 - 1. Subgrade stabilization, stabilization design, and method of stabilization shall be determined by a geotechnical engineer.
 - 2. For subgrade conditions of cohesive soils, subgrade treatment or stabilization shall be no less than 6 inches unless otherwise permitted in this document or specified by a geotechnical engineer.

10.05 CONCRETE PAVEMENT DESIGN REQUIREMENTS:

The following requirements are applicable to pavement within City street rights-of-way.

A. Minimum Pavement Thickness, Reinforcing, and Subgrade Stabilization Requirements:

1. Pavement thickness and reinforcement shall be designed by a Professional Engineer based on a current soils analysis, roadway use, traffic loadings, and life span of proposed pavement. Pavement design shall be prepared by a Professional Engineer based on current AASHTO design methodology (Guide for the Design of Pavement Structure). However, in no event shall the pavement thickness be less than the minimums stated below.
2. For Concrete Pavement Widths Less Than or Equal to 27 Feet Face-to-Face of Curb:
 - a. Minimum concrete slab thickness shall be 6 inches.
 - b. Minimum concrete strength shall be $f'c = 3500$ psi.
 - c. Minimum reinforcing steel strength shall be $f_y = 60,000$ psi.
 - d. Refer to City of Houston Standard Detail 02751-01 for concrete reinforcement details.
 - e. Minimum stabilized subgrade thickness shall be 6 inches.
 - f. The type and depth of subgrade shall be as determined by a geotechnical engineer.
3. For Concrete Pavement Widths Greater Than 27 Feet Face-to-Face of Curb and Not Major Thoroughfares:
 - a. Minimum concrete slab thickness shall be 7 inches.
 - b. Minimum concrete strength shall be $f'c = 3500$ psi.
 - c. Minimum reinforcing steel strength shall be $f_y = 60,000$ psi.
 - d. Refer to City of Houston Standard Detail 02751-01 for concrete reinforcement details.
 - e. Minimum stabilized subgrade thickness shall be 6 inches.
 - f. The type and depth of subgrade shall be as determined by a geotechnical engineer.
4. For Major Thoroughfares Constructed With Concrete Pavement:

- a. Minimum concrete slab thickness shall be 8 inches.
 - b. Minimum concrete strength shall be $f'c = 3500$ psi.
 - c. Minimum reinforcing steel strength shall be $f_y = 60,000$ psi.
 - d. Refer to City of Houston Standard Detail 02751-01 for concrete reinforcement details.
 - e. Minimum stabilized subgrade thickness shall be 8 inches.
 - f. The type and depth of subgrade shall be as determined by a geotechnical engineer.
5. Paving headers shall be placed at the end of all concrete pavements..

B. Curb Requirements:

1. 6 inch Vertical Curb:
 - a. 6 inch curb is the standard curb design.
 - b. Collector streets and streets allowing cut-through traffic in residential areas require construction of 6 inch vertical curb.
2. Laydown Curb:
 - a. Laydown curb shall be in accordance with City Standard Details.
 - b. Shall be 4 inches in height.
 - c. Is only allowed as an option for street projects on single family residential streets within the City.
 - d. Laydown curb shall not be permitted if sidewalk is to be constructed immediately adjacent to the curb.
 - e. Laydown curb construction shall provide for necessary transition lengths at curb inlets to go from laydown curb to standard vertical curb section.
 - f. Standard 6 inch vertical curb shall be extended a minimum of 10 feet beyond curb sections before beginning transitions.

10.06 GEOMETRIC DESIGN REQUIREMENTS:

A. Roadway Cross Sections:

1. The City of Houston utilizes the basic roadway cross sections shown in City of Houston Standard Drawing Nos. 10.06-01, 02 and 03, respectively. ALL variations to these three standards require the approval of the City Engineer.

2. Street Hierarchy:
 - a. The City's street hierarchy is described in the Major Thoroughfare and Freeway Plan (MTFP).

 - b. MTFP street classifications are:
 - (1) Principal Thoroughfare
 - (2) Thoroughfare
 - (3) Major Collector
 - (4) Transit Corridor

 - c. Where existing conditions or proposed adjacent development warrant the consideration of alternatives to serve specific needs such as enhanced pedestrian environments, on-street parking, and bicycle traffic, optional design sections are available in the CMP. Examples of these optional design sections are shown in Appendix 2 of this chapter.

3. Local Street Classifications (not applicable in ETJ)
 - a. Local street classification are:
 - (1) Residential Standard Density – Provides access to individual lots equal to or greater than 40 feet in width.
 - (2) Residential High Density – Provides access to individual lots less than 40 feet in width.
 - (3) Residential Main – Serves multiple streets and can be described as the “neighborhood feeder/collector.”
 - (4) A summary of the design characteristics for the three local street classifications above is included in Table 1 below. Traffic volumes shown in column “Traffic ADT” are provided as general guidelines.

TABLE 10.1
LOCAL STREET CLASSIFICATION

Street Classification	Gross Density DU/ac ⁽⁵⁾	Traffic ADT ⁽¹⁾	Min. Pav't Width(ft)	Traffic Flow Cond ⁽²⁾
Residential Std ⁽³⁾	0-6	250-350	27	Yield
Residential HD ⁽⁴⁾	6-27	350-750	32	Slow
Residential Main	0-27	≥1500	36	Free

Notes

1. ADT – average daily traffic.
2. Based on parallel on-street parking two sides.
3. Lot widths equal to or greater than 40 feet.
4. Lot widths less than 40 feet.
5. DU/AC – dwelling units (DU) per acre.

b. Design Considerations:

(1) Factors that affect the number of trips per residence include:

- (a) Number of dwelling units per acre (density).
- (b) Location of services within or near the neighborhood.
- (c) Pedestrian and bicycle facilities within the neighborhood.
- (d) Connectivity to the collector and thoroughfare network, and other factors.

(2) Traffic volume guidelines (ADT) are based on full development density.

(3) Refer to the ITE Trip Generation Information Report for further discussion of single family residential trip generation rates.

c. Design Example:

Table 2 summarizes design information for developments of various size with a density of 6 dwelling units (DU) per acre. This example is based on long block length of 700' (centerline to centerline of street), short block length of 260', typical lot size of 50' wide by 100' long, and street rights-of-way of 60'. For this example, gross acreage per block is 4.18 acres (700' x 260'), net acreage of lots is 2.94 acres (640' x 200'), number of lots per block is 25 (640/50 x 2), and gross density is 6 DU/ac (25 lots/4.18 ac) Estimates of ADT are based on a trip generation rate of 10 trips/DU/day.

TABLE 10.2
DESIGN EXAMPLE

Size (acres)	Gross Density DU/ac	No. Lots	No. Entrances	Estim ADT Resid. Street	Estim. ADT Entry/Exit Street ⁽¹⁾
25	6.0	150	1	250	1500 ⁽²⁾
25	6.0	150	2	250	750 ⁽³⁾
75	6.0	450	3	250	1500 ⁽⁴⁾
75	6.0	450	4	250	1125 ⁽⁵⁾

Notes

1. Based on even distribution of traffic per entry/exit.
2. Residential Main (150 lots x 10 trips/DU/d = 1500 ADT)
3. Residential Standard Density (150 lots x 10 trips/DU/d / 2 entrances = 750 ADT)
4. Residential Main (450 lots x 10 trips/DU/d / 3entrances = 1500 ADT)
5. Residential Standard Density (450 lots x 10 trips/DU/d / 4 entrances = 1125 ADT)

B. Horizontal Geometric Requirements:

1. Curb Radii:

a. Cul-de-Sac Curb Radii:

- (1) For approved cul-de-sac curb radii, refer to City of Houston Standard Drawing No. 10.06-09.
- (2) Curb radii around cul-de-sacs shall be 42-feet for single family areas.
- (3) Curb radii around cul-de-sacs shall be 50 feet for cul-de-sacs in areas other than single family areas.

b. Street Intersection Curb Radii:

- (1) For approved street intersection curb radii, refer to City of Houston Standard Drawing No. 10.06-04.
- (2) Variances to the standard presented in City of Houston Standard Drawing No. 10.06-04 require approval by the City Engineer.
- (3) Street intersection curb radii are a composite of needs to serve pedestrian and vehicular traffic.

2. Right-of-Way Corner Cut-Backs:

- a. For approved right-of-way corner cut-back dimensions, refer to City of Houston Standard Drawing No. 10.06-04.
- b. Right-of-way shall be dedicated for corner cut-backs on principal thoroughfares, thoroughfares, transit corridor streets, major collectors, collectors and local streets

as a requirement for subdivision platting of adjacent properties under Chapter 42 of the City of Houston Code of Ordinances.

- c. When right-of-way corner cut-backs are not feasible on local streets, cut-back easements will be required.
 - d. For Type 1 Permanent Access Easements, cut-back easements shall be provided.
 - e. Corner cut-backs of right-of-way at street intersections are necessary to provide sufficient public space for pedestrian sidewalk facilities and ramps (compliant with Americans with Disabilities Act – ADA and Texas Accessibility Standards-TAS), traffic control devices, street signs, street lighting, traffic signal equipment, and all surface encroachments which could prevent the future installation of such equipment within the cut-back area.
3. Intersection Sight Distance:
- a. Dedicated right-of-way or easements are required to meet the intersection sight distance triangle requirements.
 - b. Design Basis
 - (1) Design Vehicle – Passenger Car
 - (2) Design Standard – AASHTO “A Policy on Geometric Design of Highway and Streets”
 - (3) Lane Widths – 12 foot wide travel lanes
 - (4) Level Road Surface
 - (5) Sight Distance – Is measured to the center of the outside lane on main roadway approaching from the left and to the center of the inside lane of traffic on the main roadway approaching from the right.
 - (6) The intersection of local streets serving residential properties only, meeting at an angle of 85 degrees or more. Within 250 feet of the intersection, each of the uncontrolled approaches to the intersection of two local residential streets will:
 - 1. Have land uses adjacent to the street that are exclusively single family residential lots (or unoccupied reserves of limited size, such as landscape reserves, drainage reserves or utility reserves).
 - 2. Residential lots with driveway access to the uncontrolled approach street
 - 3. A posted (or prima facie) speed limit of 30 mph or less
 - c. Design Procedures:
 - (1) Determine design speed of main roadway. Refer to Figure 1 of Appendix 2 for design speeds of street classifications in the MTFP and CMP.
 - (2) For the appropriate design speed, determine the minimum sight distance from the following Table 10.3:

TABLE 10.3 Triangle Applicability

Triangle Applicability		
Highest classification/greater width street	Sight triangle driver’s eye setback distance	Sight triangle dimension on uncontrolled street (Design speed)
High speed major thoroughfare (>45 mph posted speed)	25 ft	sight-specific analysis
Major thoroughfare or major collector on MTFP map	25 ft	500 ft (45 mph)
Divided streets and 41 ft. streets	15 ft	500 ft (45 mph)
28 ft. local and collector streets	15 ft	390 ft (35 mph)
28 ft., single family residential frontage on both streets (1)	N/A	N/A

(3) Develop a scaled drawing depicting the sight triangle based on the design criteria. Refer to the City of Houston Standard Drawing No. 10.06-05.

d. Exceptions

- (1) Replats and partial replats at the intersections of a local/local street, local/major collector street, and major collector/major collector street are exempt from providing intersection sight distance rights-of-way or easements where existing site conditions for abutting properties preclude compliance.
- (2) Variances or deviations to these guidelines will be considered on a site-by-site basis. An engineering analysis should be prepared to support the proposed sight triangle dimensions, based on criteria in the AASHTO “Green Book”, latest edition. Where the uncontrolled street is existing, design speeds should be based on an analysis of the 85th percentile operating speed.

4. Median Design:

a. Minimum Median Width:

- (1) For local streets, refer to City of Houston Standard Drawing No. 10.06-02.
- (2) For street classifications depicted on the MTFP, refer to City of Houston Standard Drawing No. 10.06-02.
- (3) For streets classified as multi-modal under the CMP, please refer to Appendix 2 of Chapter 10.

b. Minimum Median Length:

- (1) Median lengths are based on functional street classification of the main roadway and intersecting street.
 - (2) Refer to City of Houston Standard Drawing No. 10.06-06 for minimum median length requirements.
- c. Median Geometry – Refer to City of Houston Standard Drawing No. 10.06-07
- d. Street Taper Geometry – Refer to City of Houston Standard Drawing No. 10.06-08 for subdivision street taper geometrics.
5. Left Turn Lanes:
- a. Left Turn Lanes are Required:
 - (1) At all signalized intersection approaches on principal thoroughfares and thoroughfares.
 - (2) At all signalized intersection approaches on major collectors and collectors as directed by the City Engineer.
 - b. Left Turn Lane Design Standards:
 - (1) Refer to City of Houston Standard Drawing No. 10.06-07 for left turn bay geometrics.
 - (2) The centerline of left turn lanes shall not be offset greater than three feet horizontally across the intersection, and the offset for through vehicles in all lanes shall not exceed three feet horizontally across the intersection.
 - (3) The volume of left turn movements shall be based on projections developed in the City Mobility Plan or based on traffic studies reviewed and approved by the City Engineer.
 - c. Dual Left Turn Lanes:
 - (1) Are required when left turn movement exceeds 300 vehicles for the peak hour, or when traffic analysis of the intersection indicates existing or projected left turn storage space requires dual left turn lanes before the volume threshold is reached.
 - (2) Where dual left turn lanes are required, right of way for the intersection shall be based on the width required for dual left turns, through lanes, a right turn lane, and minimum landscape/pedestrian zone of ten feet (dimension S) as shown in City of Houston Standard Drawing No. 10.06-02.
 - d. Special conditions or other constraints may require design criteria other than shown herein.
 - (1) Exceptions to the requirements must be demonstrated by submittal of a traffic study encompassing AASHTO criteria.
 - (2) Approval by City Engineer is required for all variances to standard.

C. Vertical Geometric Requirements:

1. For Curb and Gutter Pavement Sections:

- a. Minimum grade line shall be 0.30 percent.
- b. Minimum grade line shall be 1 percent for radii of 35 feet or less around intersection turnouts. Grades for larger radii shall be determined on an individual basis.
- c. Superelevation – Major thoroughfares shall be superelevated in accordance with AASHTO requirements.
- d. Vertical Curves:
 - (1) Shall be installed when the algebraic difference in grades exceeds 1 percent.
 - (2) Elevations shall be shown at 10-foot intervals through vertical curves.
 - (3) Maintain a minimum of 0.03-foot elevation change at 10-foot intervals by altering calculated elevations.
 - (4) Determine minimum vertical curve lengths based on AASHTO design criteria (minimum 3 times design speed) using a minimum design speed of 45 miles per hour for thoroughfares and collector streets and 35 mph for residential streets.
- e. Minimum grade line around a cul-de-sac shall be 0.70 percent.
- f. Pavement Cross Slopes:
 - (1) Cross slopes for pavement shall be a minimum of 1/4 inch per foot.
 - (2) Cross slopes for left-turn lanes and esplanade openings shall be 1/8 inch per foot minimum.

2. Railroad Crossings

- a. Maximum Tangent Grade to Vertical Curves At Railroad Crossings:
 - (1) 8 percent for local streets
 - (2) 3.5 percent for major thoroughfares
- b. Roadway grades at railroad crossings shall be zero percent from centerline of the track to 10 feet either side of the track's centerline, and should not cause a drop of more than 6 inches from the top-of-rail elevation at a distance of 30 feet either side of the track's centerline.
- c. For concrete roadways, the roadway shall terminate at a railroad header, 6 feet from the centerline of the track and the roadway cross slope shall be zero from the railroad header to 4 feet before the railroad header.

- d. At railroad track approaches, decrease curbs from 6 inches to zero inches in 2 feet at a distance of 10 feet from the nearest track centerline.

D. Sidewalks and Accessibility Ramps:

1. Accessibility ramps shall be constructed at all intersections.
2. Ramps, approaches and sidewalks shall be comply with ADA and TAS requirements.
3. Approved sidewalk/ramp details are shown in the City's Standard Details. Use of these details are specific to certain field conditions such as ramp direction, driveway crossings, crosswalk locations and the location of the sidewalk with respect to the curb.
4. Where use of standard sidewalk/ramp details is not possible due to field conditions, engineer shall submit proposed design drawings to City Engineer for approval. Design drawings shall include site field survey conditions.
5. Accessibility ramps should cross street at 90 degrees to centerline of street.
6. All ramps constructed on an intersection corner should be interconnected for pedestrian access continuity.
7. Mid-block crosswalks are not permitted without approval by City Engineer. The specific conditions which warrant a mid-block crosswalk must be provided to support the request for a design variance.
8. Sidewalks at intersections are to be provided with unobstructed areas as shown in Standard Drawing No. 10.06-04 and are to be free of obstructions and surface encroachments such as sign posts, power poles and down guy wires within that area.
9. Concrete Sidewalk in Esplanades:
 - a. 6 inch thick reinforced concrete sidewalk shall be constructed in esplanades when curbs are 10 feet face to face of curb or less in width with a minimum length of 6 feet measured from the face of curb of the esplanade nose.
 - b. Reinforced concrete sidewalk in esplanades shall be colored black for concrete roadways.
 - c. Reinforced concrete sidewalk in esplanades shall be uncolored for asphaltic concrete roadways.
10. Sidewalks for Transit Corridor Street and Type A Streets:

- a. Chapter 42, Article IV - Transit Corridor Development, of the Code of Ordinances regulates improvements constructed in the public right of way within 1,320 feet of each transit station (Ch. 42, Sec 401-406).
- b. Mandatory requirements are summarized below and shown in Standard Detail 02775-08. These requirements are required under IBC, Section 3110.
 - (1) Minimum Sidewalk Width – 6 feet (must be located within the public right of way).
 - (2) Minimum Vertical Clear Zone, a continuous obstacle free path, for a minimum width of six feet and a minimum height of seven and one-half feet.
- c. Performance Standards – Refer to Chapter 42 Sections 401-406:
 - (1) Minimum Pedestrian Realm – 15 feet distance from back of curb to a buildings facade or other improvements (can be entirely within public right of way or a combination of public right of way and public access easement).
 - (2) Maximum Softscape area in the pedestrian realm is 20% of the surface area of the pedestrian realm excluding any driveways and shall be located at least two feet from the back-of-curb of any street area used for parking.

E. Alleys:

1. Design standards for a Public Use Alley are shown in City of Houston Standard Drawing No. 10.06-10.
2. An offer of dedication of right of way to the public is required for a Public Use Alley and such offer must be formally accepted by the City for implementation of public maintenance services.
3. A log of all public use alleys is maintained by PWE on the GIM's website.
4. The minimum design standards for a Private Use Alley are shown in City of Houston Standard Drawing No. 10.06-11.
5. The right of way for a Private Use Alley is owned and maintained by the abutting property owners.
6. Signs shall be erected by the developer at the entrance to the alley (or by the abutting property owners for existing alleys) which state "PRIVATE ALLEY – NOT A PUBLIC WAY". See City of Houston Standard Drawing 10.06-11 for sign details.

F. Street Terminations:

1. Where cul-de-sac streets are approved, design geometrics shall comply with City of Houston Standard Drawing No. 10.06-09.

2. Where termination of a private street or Type 2 Permanent Access Easement is approved, design geometrics shall comply with City of Houston Standard Drawing No. 10.06-09.
3. Dead-End Streets – Standard City of Houston barricades shall be placed at the end of dead-end streets not terminating in cul-de-sacs. Refer to City of Houston Standard Detail No. 01580-01.
4. Temporary Street Termination:
 - a. Temporary termination of streets (for future extension into adjacent development) shall include construction of street barricades as shown in City of Houston Standard Detail No. 01580-01.
 - b. A sign shall be mounted on the street barricade with the statement: “STREET IS A THROUGH STREET AND WILL BE EXTENDED AT A FUTURE DATE.”

10.07 STREET CONNECTIONS AND TRANSITIONS:

A. Street Transition Requirements:

1. For Concrete Streets:
 - a. When transitioning from a proposed concrete street to an existing concrete street, the transition shall consist of concrete, and shall equal the existing concrete pavement thickness with a minimum thickness of 6 inches.
 - b. Refer to City of Houston Standard Detail 02751-01.
2. For Streets Other Than Concrete Pavement:
 - a. When transitioning from a proposed street to an existing street constructed of something other than concrete, the transition shall consist of flexible base paving.
 - b. Refer to City of Houston Standard Drawing No. 10.06-03.

B. Proposed Curb and Gutter Street Connecting to an Existing Roadside Ditch Street:

1. The standard transition length for meeting a roadside ditch street is:
 - a. 50 feet for street widths less than or equal to 27 feet face to face of curb.
 - b. 75 feet for street widths equal to 36 feet face to face of curb.
 - c. 100 feet for street widths equal to 40 feet face to face of curb.

- C. Proposed Curb and Gutter Street Connecting to an Existing Curb and Gutter Street:
1. When meeting an existing curb-and-gutter street, top-of-curb elevations shall be designed to meet an elevation 6 inches above the existing gutter.
 2. At existing inlets, top-of-curb elevations shall be designed to match existing top-of-curb elevations.
- D. Construction Requirements for Connecting a Proposed Concrete Street with an Existing Concrete Street:
1. When meeting existing concrete streets at right angles, the existing street should be saw cut in a V-shape extending from the curb returns to a point where the centerline of the proposed pavement intersects the quarter point of the existing concrete street to create a crowned intersection. In the event this construction creates a situation in which traffic on the existing street, at design speed, will bottom out when crossing the proposed street intersection, a special design will be allowed to eliminate this potentially dangerous condition.
 2. Concrete to be removed shall be removed either to an existing joint or a sawed joint. The groove of the sawed joint shall be cut to a minimum depth of 2 inches along the line designated by the Professional Engineer.
 3. When meeting existing concrete pavement, horizontal dowels shall be used if no exposed reinforcing steel exists. Horizontal dowels shall be Grade 60 bars, 24 inches long, drilled and embedded 12 inches into the center of the existing slab with PO ROC, or approved equal. Dowels shall be 12 inches center-to-center, unless otherwise specified.
 4. When concrete is removed for connection with proposed concrete pavement, the pavement shall be saw cut and existing concrete removed to expose a minimum of 15 inches of reinforcing steel. If no reinforcing steel exists, use horizontal dowels per Paragraph 10.07 D.3.
- E. Pavement Connection Special Requirements:
1. At a T-intersection with a street that has not been improved to its ultimate width, concrete shall be stopped either at the right-of-way line or the end of the curb return. The option that will require the least concrete removal at a future date should be chosen.
 2. For roadway turnouts placed at an existing cross street intersection, the turnout should be designed to fit the ultimate pavement width of the intersecting cross street and then transitioned to the existing roadway.
- F. L – Type Street

The minimum grade line around the longest radius on an L-type street shall be 0.40 percent.

10.08 SPECIAL REQUIREMENTS:

- A. Pavement Crossing Pipelines – A Letter of agreement between the City and pipeline company is required when paving is placed over a transmission pipeline.
- B. Thoroughfare Construction Considerations:
 - 1. When the full section of a thoroughfare is located within the city limits and is dedicated on a final plat, the esplanade and all lanes of the thoroughfare shall be constructed at the time of initial construction of the roadway.
 - 2. If approved by the City Engineer, lanes contained within a plat, left-turn lanes and the esplanade to the centerline of the right-of-way shall be constructed at the time of initial construction of the roadway when only one side of a thoroughfare is located on a final plat. The remaining lanes, left-turn lanes and esplanade shall be constructed at the time the final plat containing the opposite side of the thoroughfare is approved.
- C. Inlets and Manholes
 - 1. The inlet spacing and the maximum allowable curb run to an inlet shall be provided in accordance with Ch 9.
 - 2. City approved inlets shall be used on all curbs and gutter sections within the city limits and in the ETJ.
 - 3. Keep proposed inlets away from esplanade opening and out of major thoroughfare intersections. For intersections between a major thoroughfare and minor street, locate inlets at the end of return (E/R) of the side street.
 - 4. Inlets shall be placed at the end of pavement in order to eliminate drainage from the pavement gutter into a road ditch.
 - 5. when curb and gutter streets connects to roadside ditches street, place inlets at end of curb and gutter street with reinforced concrete pipe stubs with rings to collect ditch storm water. See standard detail 02632-11- Side Street Ditch Reception
 - 6. Use only City standard cast iron grates for curb inlets.
 - 7. Adjust existing manhole frames and covers within the limits of the proposed pavement to meet the proposed top-of-slab elevation.
 - 8. Adjust existing manhole frames and covers outside the limits of pavement to conform to the final grading plan.
- D. When a curb and gutter street intersects a drainage ditch, the gutter elevation shall be above

the designed water surface elevation of the ditch.

E. Fill/Cut For Proposed Pavement:

a. Fill Placement For Curb and Gutter Pavement Sections:

- (1) Fill shall be placed to ensure a minimum of 3/8 inches per foot transverse slope toward the curb from the property line. Fill shall be placed between the curb and a point 2 feet outside of the right-of-way.
- (2) Where fill as described above is required, and the pavement is adjacent to a nonparticipating property owner, fill easements shall be obtained, filed, and a copy of the easement shall accompany the final drawings.
- (3) Construction of this nature will require back-slope drainage design to prevent trapping storm runoff.

- b. When pavement or curb grades are established below natural ground, slope lines shall be shown on the drawings.

F. Drawings

1. Construction drawings shall be prepared in accordance with Chapter 3, Graphic Requirements.
2. Top-of-curb grade for the outside lanes shall be labeled except at railroad crossings where gutter grades shall be labeled. Centerline grades are acceptable for sheets with roadside ditch sections.
3. For proposed driveways, call out centerline stations, widths, and radii.

END OF CHAPTER

APPENDIX 1

CHAPTER 10

GEOMETRIC DESIGN GUIDELINES FOR SUBDIVISION STREETS

HARRIS COUNTY CITY OF HOUSTON

The Guidelines presented in Appendix 1 include the most often requested information regarding geometric design of subdivision streets. Designated Major Thoroughfares and Collector Streets shall be considered for special design features such as presented in Appendix 2 of this Chapter. Design features not shown in Appendix 1 should be considered special design features. Agency Engineer as used throughout this section shall mean City Engineer for the City of Houston and the designated representative for Harris County Public Infrastructure Department. The average daily traffic volumes presented in Standard Drawing No. 10.06-01, 02, and Appendix 2 Figure 1 are provided as general guidelines to define each street classification. Professional engineering experience and judgment should be used in application of the guidelines to a specific project.

It is advisable to consult with the appropriate agencies and review the most recent edition of the following publications to determine adequate thoroughfare requirements and special design features.

- Recommended Guidelines for Subdivision Streets, Institute of Transportation Engineers
- Guidelines for Urban Major Streets Design, Institute of Transportation Engineers
- A Policy on Geometric Design of Highways and Streets, American Associations of State Highway and Transportation Officials (AASHTO)
- Texas Manual on Uniform Traffic Control Devices (TMUTCD), Texas Department of Transportation

THE GUIDELINES IN THIS APPENDIX ARE HEREBY APPROVED AS BASIC REQUIREMENTS FOR FUTURE STREET PLANNING AND DEVELOPMENT

JULY 2009



Director
Department of Public Works & Engineering
City of Houston

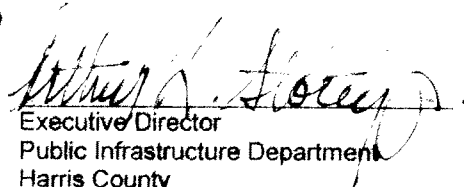

Executive Director
Public Infrastructure Department
Harris County

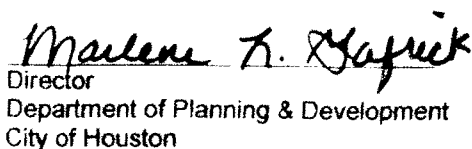

Director
Department of Planning & Development
City of Houston

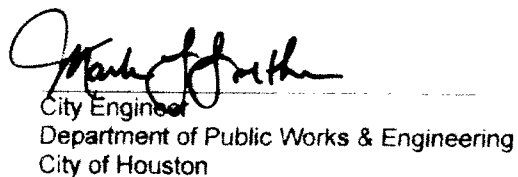

City Engineer
Department of Public Works & Engineering
City of Houston

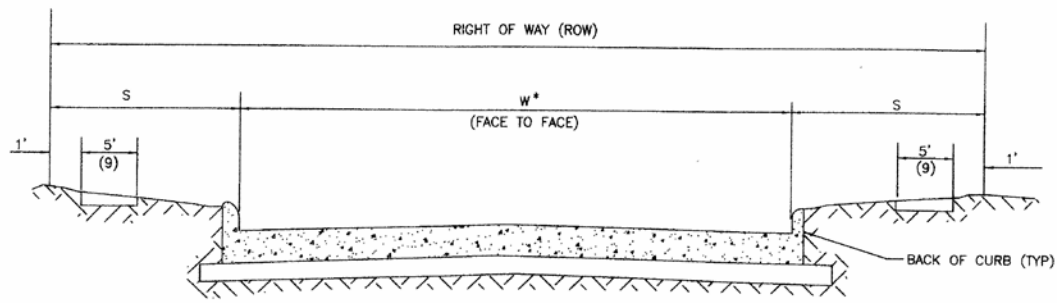

UNDIVIDED STREET DIMENSIONS (FEET)

	LOCAL STREET					ALL OTHER	
	SINGLE FAMILY RESIDENTIAL (SFR)		RESIDENTIAL MAIN			APT/ COMM	MAJOR
	STANDARD DENSITY LOT(2)	HIGH DENSITY LOT(3)	WITHOUT MEDIAN	WITH MEDIAN	(4)(6)	(5)(6)	
ADT (1)	250-350	350-750	≥1500	≥1500	500-5000	1500-5000	
ROW	50	60	55	60	60	70	
W^*	27	27	32	32	40	44	
S	11.5	16.5	11.5	14	10	13	

SEE DIMS. NO. 10.06-02

NOTES:

1. AVERAGE DAILY TRAFFIC. REFER TO GUIDELINES PRESENTED IN SECTION 10.06A.
2. STANDARD LOT: LOT WIDTHS 40 FEET OR GREATER.
3. HIGH DENSITY LOT: LOT WIDTHS LESS THAN 40 FEET.
4. APARTMENT/COMMERCIAL: ANY PROPERTY USE OTHER THAN SINGLE FAMILY, RESIDENTIAL.
5. MAJOR: ANY ROADWAY DESIGNATED AS A MAJOR COLLECTOR ON THE MAJOR THOROUGHFARE AND FREEWAY PLAN.
6. ABUTTING LAND USE: AS REQUIRED BY CHAPTER 42 OF THE CODE OF ORDINANCES.
7. WIDTH (W) DOES NOT INCLUDE WIDTH FOR BICYCLE LANES. REFER TO APPENDIX 2 FOR MINIMUM REQUIREMENTS. REQUIRES APPROVAL OF AGENCY ENGINEER.
8. REQUESTS FOR ALTERNATIVE STREET CROSS SECTION SHALL BE SUBMITTED TO AGENCY ENGINEER FOR REVIEW.
9. 5' MINIMUM WIDTH IS CITY OF HOUSTON STANDARD FOR NON-TRANSIT CORRIDOR STREETS. MINIMUM WIDTH FOR TRANSIT CORRIDOR STREETS IS 6'. FOR MINIMUM WIDTH IN ETJ CONTACT AGENCY ENGINEER.

NOT APPLICABLE IN EXTRA-TERRITORIAL JURISDICTION (ETJ) OF CITY OF HOUSTON.

W^* WIDTH (W) INCLUDES ON STREET PARALLEL PARKING WHERE APPROVED BY AGENCY ENGINEER.

CITY OF HOUSTON
DEPARTMENT OF PUBLIC WORKS AND ENGINEERING

UNDIVIDED STREET
TYPICAL CROSS SECTION

(NOT TO SCALE)

APPROVED BY: CITY ENGINEER	APPROVED BY: DIRECTOR OF PUBLIC WORKS AND ENGINEERING
EFF DATE: JULY-01-2009	DWG NO: 10.06-01

PREVIOUS NO: CH 10 FIG 02

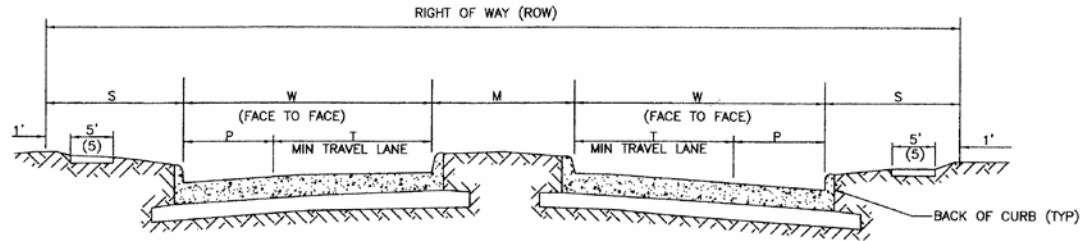

DIVIDED STREET DIMENSIONS (FEET)

	LOCAL STREET SINGLE FAMILY RESIDENTIAL		MAJOR STREET					SEE AGENCY ENGINEER
	RESIDENTIAL MAIN STD CENTER SW	RESIDENTIAL MAIN CENTER SW(3)	PRINCIPAL THOROUGHFARE, THOROUGHFARE, MAJOR COLLECTOR, COLLECTOR (4)					
ADT (1)	>1500	>1500	5000-50,000					
ROW (2)	70	80	80	90	100	100	>100	
W	20	20	24	24	24	33		
M	8	24	14	22	32	14		
S	11	8	9	10	10	10		
T	12	12	24	24	24	33		
P	8	8	0	0	0	0		

NOT APPLICABLE IN EXTRA-TERRITORIAL JURISDICTION (ETJ) OF CITY OF HOUSTON.

NOTES:

1. AVERAGE DAILY TRAFFIC. REFER TO GUIDELINES PRESENTED IN SECTION 10.06A.
2. ANY RIGHT-OF-WAY DIMENSIONS DIFFERENT FROM THOSE SHOWN SHALL REQUIRE SPECIAL GEOMETRIC DESIGN AS DETERMINED BY AGENCY ENGINEER.
3. SIDEWALK LOCATED IN CENTER MEDIAN ONLY (MIN. SW WIDTH-6')
4. REFER TO CITY MOBILITY PLAN (INFRASTRUCTURE DESIGN MANUAL, CHAPTER 10, APPENDIX 2) FOR OPTIONAL DESIGNS TO SERVE SPECIAL MOBILITY NEEDS, PEDESTRIAN NEEDS, BICYCLE LANES, OR OTHER REQUIREMENTS. APPROVAL BY CITY ENGINEER REQUIRED.
5. 5' MINIMUM WIDTH IS CITY OF HOUSTON STANDARD FOR NON-TRANSIT CORRIDOR STREETS. MINIMUM WIDTH FOR TRANSIT CORRIDOR STREETS IS 6'. FOR MINIMUM WIDTH IN ETJ CONTACT AGENCY ENGINEER.

CITY OF HOUSTON DEPARTMENT OF PUBLIC WORKS AND ENGINEERING	
DIVIDED STREET TYPICAL CROSS SECTION (NOT TO SCALE)	
APPROVED BY: <i>Mark A. Hock</i> CITY ENGINEER	APPROVED BY: <i>Michael S. Mancetta</i> DIRECTOR OF PUBLIC WORKS AND ENGINEERING
EFF DATE: JULY-01-2009	DWG NO: 10.06-02

PREVIOUS NO: CH 10 FIG 01

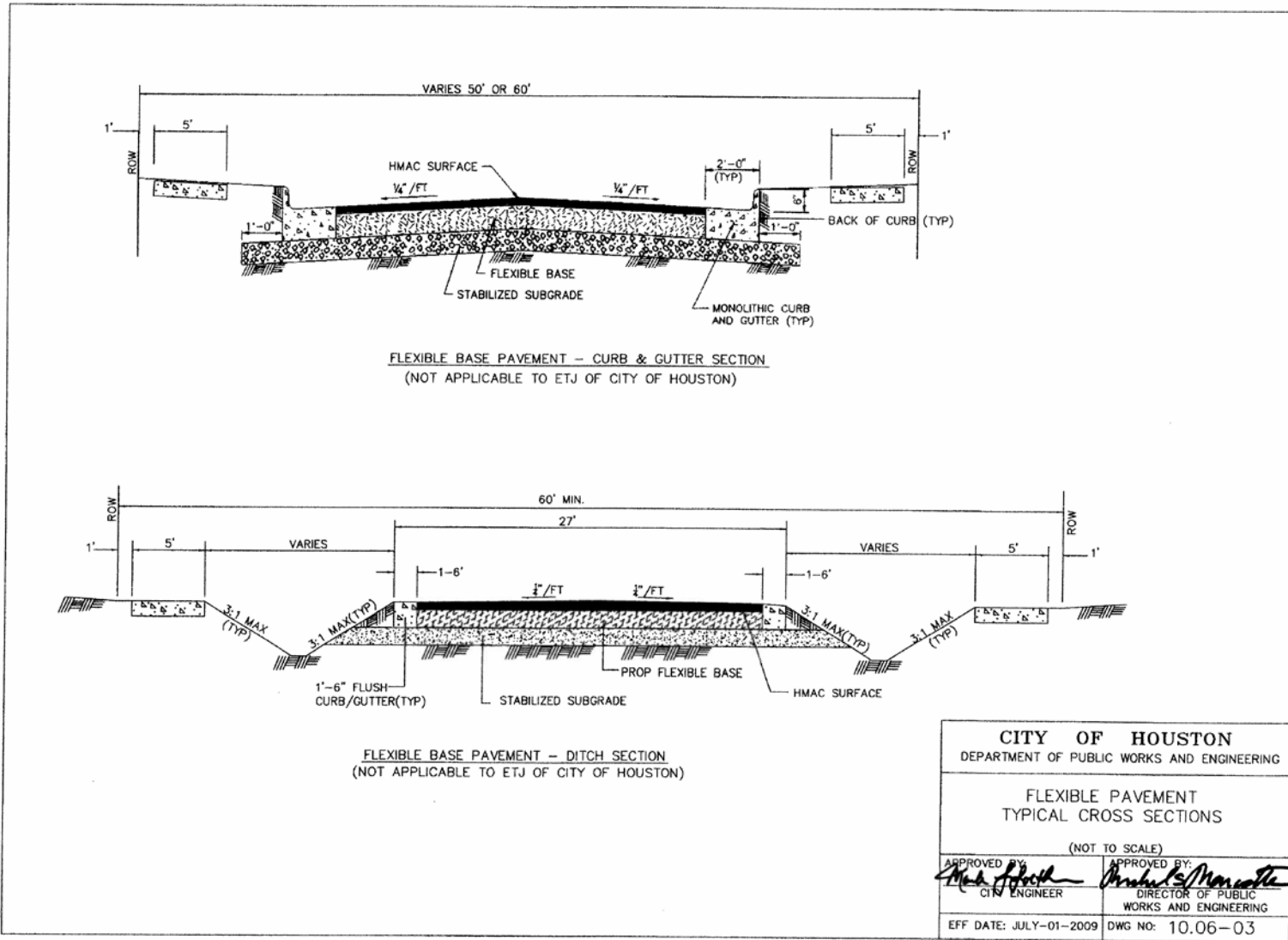

NOTES:

1. ALL RAMPS AND SIDEWALKS SHALL BE CONSTRUCTED IN ACCORDANCE WITH AGENCY STANDARD DETAILS, AMERICANS WITH DISABILITIES ACT (ADA) AND TEXAS DEPARTMENT OF LICENSING AND REGULATION (TDLR) REQUIREMENTS.
2. ALL PAVEMENT MARKINGS SHALL BE INSTALLED IN ACCORDANCE WITH AGENCY STANDARD DETAILS AND THE TEXAS MANUAL ON UNIFORM TRAFFIC CONTROL DEVICES (TMUTCD).
3. CURB RADII SHALL BE DESIGNED TO ACCOMMODATE THE TYPE OF VEHICLES ANTICIPATED TO USE THE FACILITY, (I.E., BUSES, TRUCKS, ETC.) IN ACCORDANCE WITH AASHTO CRITERIA FOR TURNING VEHICLES.
4. WHERE ALTERNATIVE MINIMUM CURB RADIUS IS REQUIRED TO SERVE MOBILITY, PEDESTRIAN, OR OTHER SPECIAL NEEDS, SUBMIT DESIGN LAYOUT AND SUPPORTING CALCULATIONS TO AGENCY ENGINEER FOR REVIEW AND APPROVAL.
5. THE CORNER CUT AREA IS RESERVED FOR TRAFFIC SIGNAL EQUIPMENT AND SHALL BE KEPT FREE OF SIGNS, POLES, PRIVATE UTILITY CONTROL CABINETS AND ALL SURFACE ENCROACHMENTS WHICH COULD PREVENT THE FUTURE INSTALLATION OF SUCH EQUIPMENT WITHIN THE AREA.
6. WHERE A NEW ROADWAY OR DRIVEWAY IS CONNECTING TO AN EXISTING SIGNALIZED INTERSECTION, THE APPLICANT SHALL BE RESPONSIBLE FOR DESIGNING AND CONSTRUCTING THE NECESSARY MODIFICATIONS TO THE EXISTING SIGNAL SYSTEM AS REQUIRED BY AGENCY ENGINEER.

TABLE 1. INTERSECTION CURB RADIUS REQUIREMENTS

INTERSECTION TYPE	MINIMUM CURB RADIUS BY INTERSECTION ANGLE		
	90 DEG.	85-90 DEG.	80-85 DEG.
LOCAL - LOCAL	25 FT	30 FT	30 FT
COLLECTOR - LOCAL	25 FT	30 FT	30 FT
COLLECTOR - COLLECTOR	30 FT	30 FT	35 FT
THOROUGHFARE - COLLECTOR	30 FT	35 FT	35 FT
THOROUGHFARE - THOROUGHFARE	35 FT	35 FT	40 FT
PRINCIPAL THOROUGHFARE - THOROUGHFARE	35 FT	35 FT	40 FT
PRIN. THOROUGHFARE - PRIN. THOROUGHFARE	35 FT	35 FT	40 FT

TABLE 2. ROW CUTBACK REQUIREMENTS

CURB RADIUS	MINIMUM ROW CUTBACK "X"	ROW RADIUS R(1)
25 FT	15 FT X 15 FT	25 FT
30 FT	20 FT X 20 FT	30 FT
35 FT	25 FT X 25 FT	35 FT
40 FT	30 FT X 30 FT	40 FT
45 FT	35 FT X 35 FT	45 FT

(*) SKETCH SHOWS ACCEPTABLE PROPERTY CUTBACK DISTANCE X AS SUBSTITUTE FOR ROW RADIUS R.

CITY OF HOUSTON
DEPARTMENT OF PUBLIC WORKS AND ENGINEERING

INTERSECTION GEOMETRY
CURB RADIUS AND CORNER CUTBACK
(NOT TO SCALE)

APPROVED BY: *Mark R. Smith*
CITY ENGINEER

APPROVED BY: *Michael S. Macosta*
DIRECTOR OF PUBLIC WORKS AND ENGINEERING

EFF DATE: JULY-01-2009 DWG NO: 10.06-04

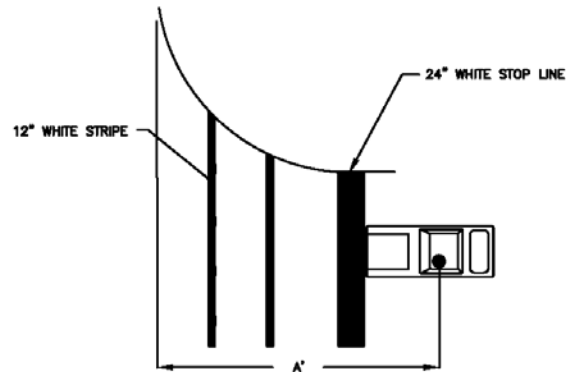
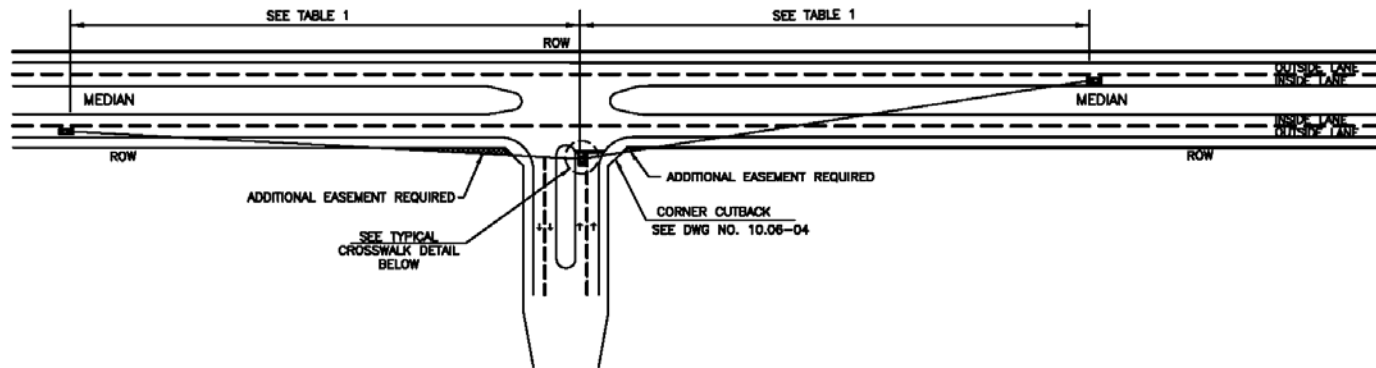

TYPICAL CROSSWALK AND STOP BAR PLACEMENT DETAIL

TABLE 1
REQUIRED INTERSECTION SIGHT DISTANCE

STREET CLASSIFICATION	SIGHT DISTANCE (*)	A
LOCAL STREET	390'	15'
ALL OTHER STREETS	500'	25'

(*) BASED ON AASHTO INTERSECTION SIGHT DISTANCE CRITERIA.

NOTES:

1. INTERSECTION SIGHT DISTANCES ARE BASED ON AMERICAN ASSOCIATION OF STATE HIGHWAY AND TRANSPORTATION OFFICIALS (AASHTO) CRITERIA FOR INTERSECTION SIGHT DISTANCE.
2. IF ROADWAY BEING CROSSED OR TURNED ONTO HAS A MEDIAN THAT IS 25 FEET OR GREATER, SIGHT DISTANCE TO THE RIGHT MAY BE MEASURED FROM THE POINT AT WHICH A VEHICLE CAN SAFELY STOP WITHIN THE MEDIAN OPENING.

CITY OF HOUSTON DEPARTMENT OF PUBLIC WORKS AND ENGINEERING	
INTERSECTION GEOMETRY SIGHT DISTANCE TRIANGLE	
(NOT TO SCALE)	
APPROVED BY:	APPROVED BY:
CITY ENGINEER	DIRECTOR OF PUBLIC WORKS AND ENGINEERING
EFF DATE: JULY-01-2012	DWG NO: 10.06-05

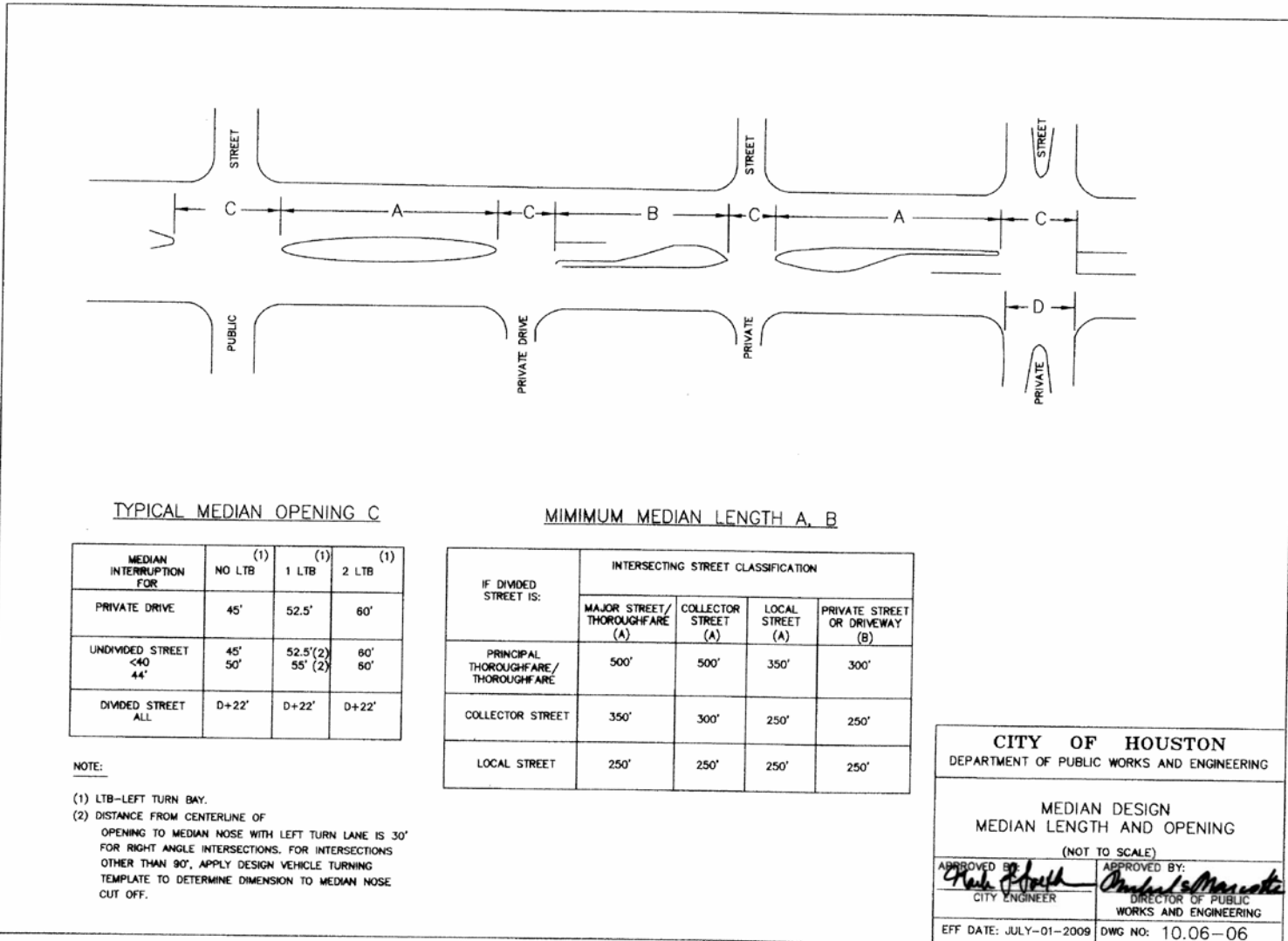

TYPICAL MEDIAN OPENING C

MEDIAN INTERRUPTION FOR	(1)		
	NO LTB	1 LTB	2 LTB
PRIVATE DRIVE	45'	52.5'	60'
UNDIVIDED STREET <40 44'	45' 50'	52.5'(2) 55'(2)	60' 60'
DIVIDED STREET ALL	D+22'	D+22'	D+22'

NOTE:
 (1) LTB—LEFT TURN BAY.
 (2) DISTANCE FROM CENTERLINE OF OPENING TO MEDIAN NOSE WITH LEFT TURN LANE IS 30' FOR RIGHT ANGLE INTERSECTIONS. FOR INTERSECTIONS OTHER THAN 90°, APPLY DESIGN VEHICLE TURNING TEMPLATE TO DETERMINE DIMENSION TO MEDIAN NOSE CUT OFF.

MINIMUM MEDIAN LENGTH A, B

IF DIVIDED STREET IS:	INTERSECTING STREET CLASSIFICATION			
	MAJOR STREET/ THOROUGHFARE (A)	COLLECTOR STREET (A)	LOCAL STREET (A)	PRIVATE STREET OR DRIVEWAY (B)
PRINCIPAL THOROUGHFARE/ THOROUGHFARE	500'	500'	350'	300'
COLLECTOR STREET	350'	300'	250'	250'
LOCAL STREET	250'	250'	250'	250'

CITY OF HOUSTON
DEPARTMENT OF PUBLIC WORKS AND ENGINEERING

MEDIAN DESIGN
MEDIAN LENGTH AND OPENING
(NOT TO SCALE)

APPROVED BY: <i>Paul Powell</i> CITY ENGINEER	APPROVED BY: <i>Michael Maricote</i> DIRECTOR OF PUBLIC WORKS AND ENGINEERING
EFF DATE: JULY-01-2009	DWG NO: 10.06-06

PREVIOUS NO: CH 10 FIG 3

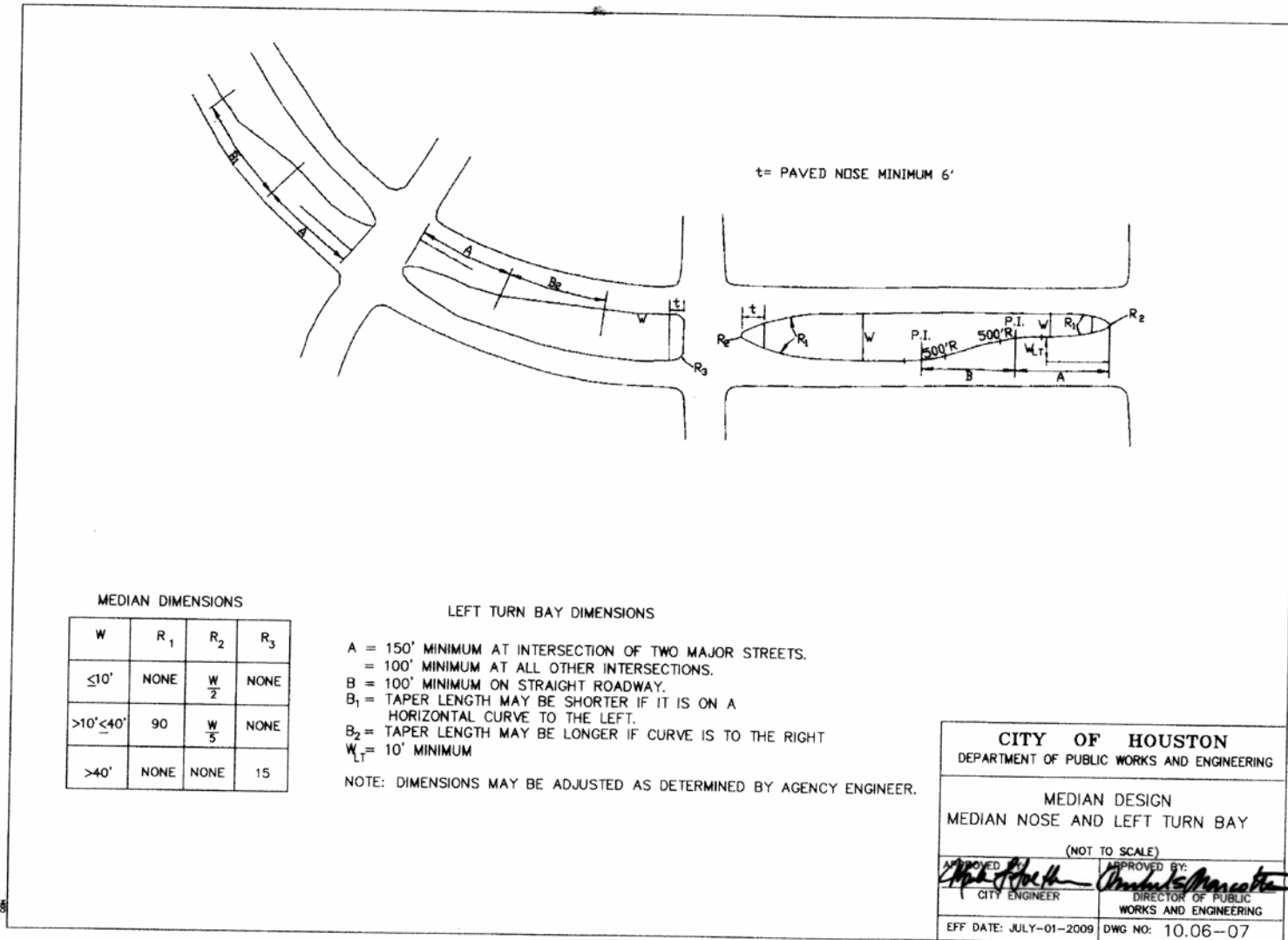

PREVIOUS NO: CH 10 FIG 4

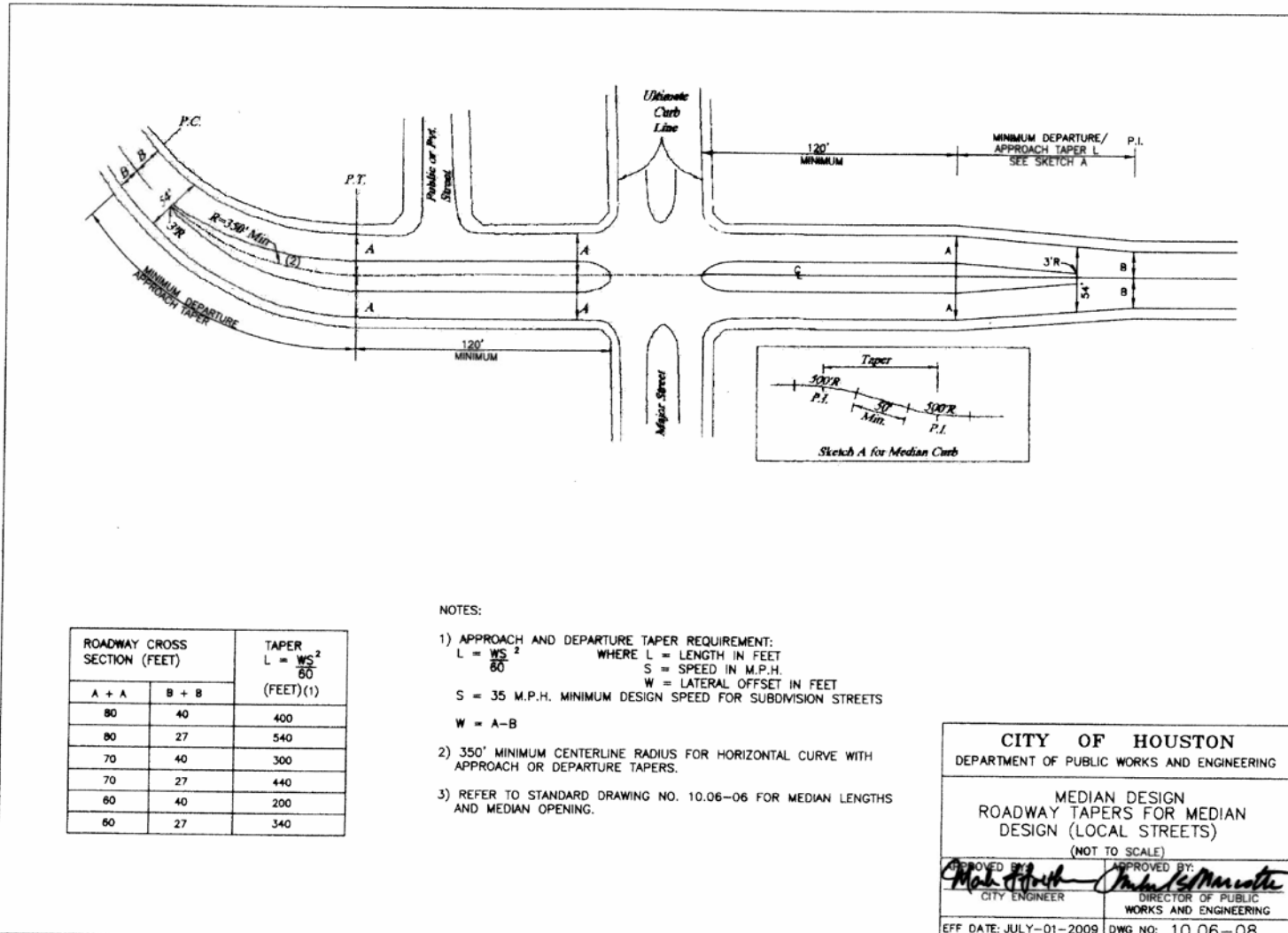

- NOTES:
- 1) APPROACH AND DEPARTURE TAPER REQUIREMENT:
 $L = \frac{WS^2}{80}$ WHERE L = LENGTH IN FEET
 S = SPEED IN M.P.H.
 W = LATERAL OFFSET IN FEET
 S = 35 M.P.H. MINIMUM DESIGN SPEED FOR SUBDIVISION STREETS
 W = A-B
 - 2) 350' MINIMUM CENTERLINE RADIUS FOR HORIZONTAL CURVE WITH APPROACH OR DEPARTURE TAPERS.
 - 3) REFER TO STANDARD DRAWING NO. 10.06-06 FOR MEDIAN LENGTHS AND MEDIAN OPENING.

CITY OF HOUSTON
 DEPARTMENT OF PUBLIC WORKS AND ENGINEERING

MEDIAN DESIGN
 ROADWAY TAPERS FOR MEDIAN
 DESIGN (LOCAL STREETS)
 (NOT TO SCALE)

DESIGNED BY: *Mark Abbott* CITY ENGINEER
 APPROVED BY: *John L. Marotta* DIRECTOR OF PUBLIC WORKS AND ENGINEERING

EFF DATE: JULY-01-2009 DWG NO: 10.06-08

PREVIOUS NO: CH 10 FIG 7

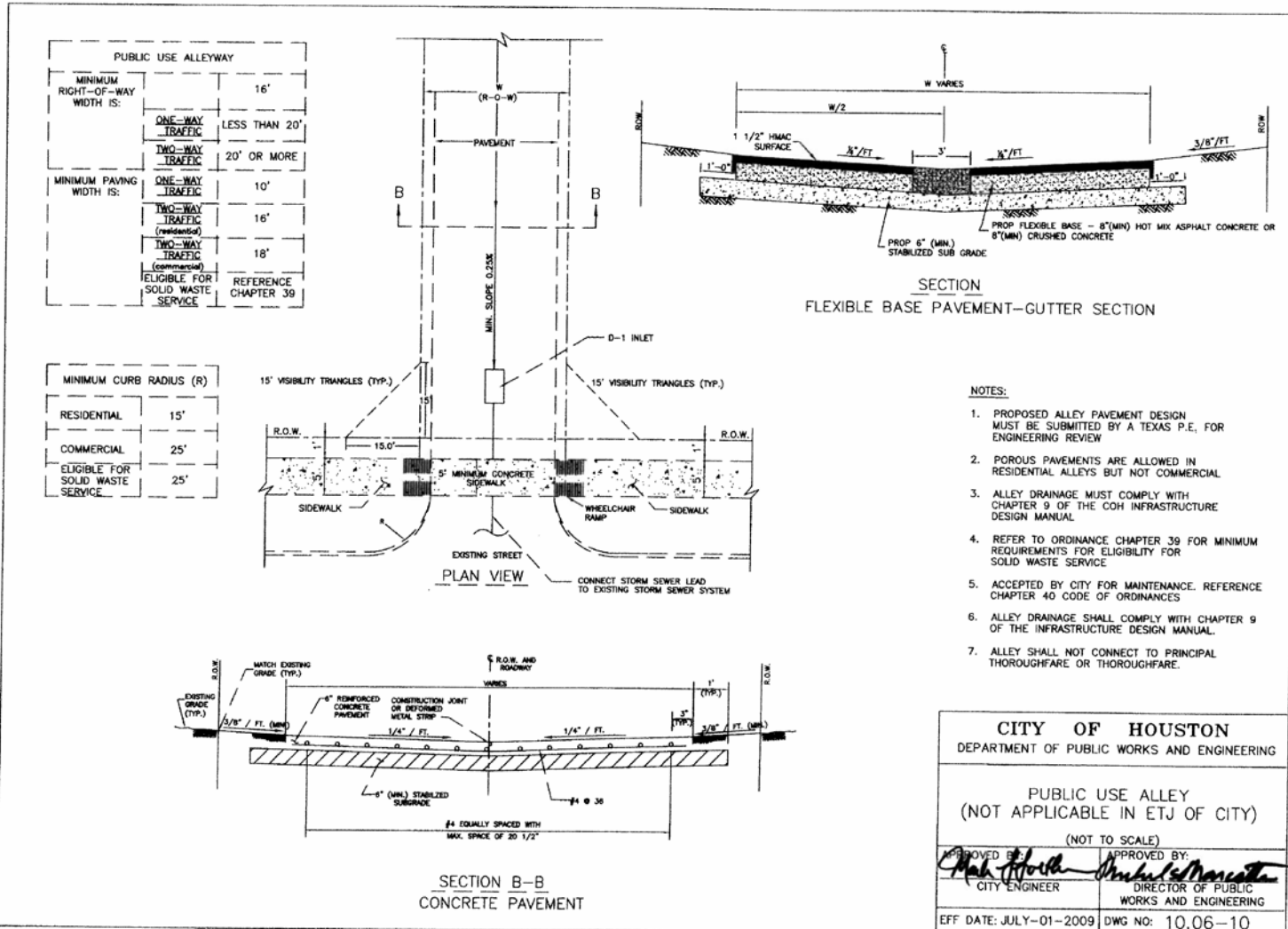

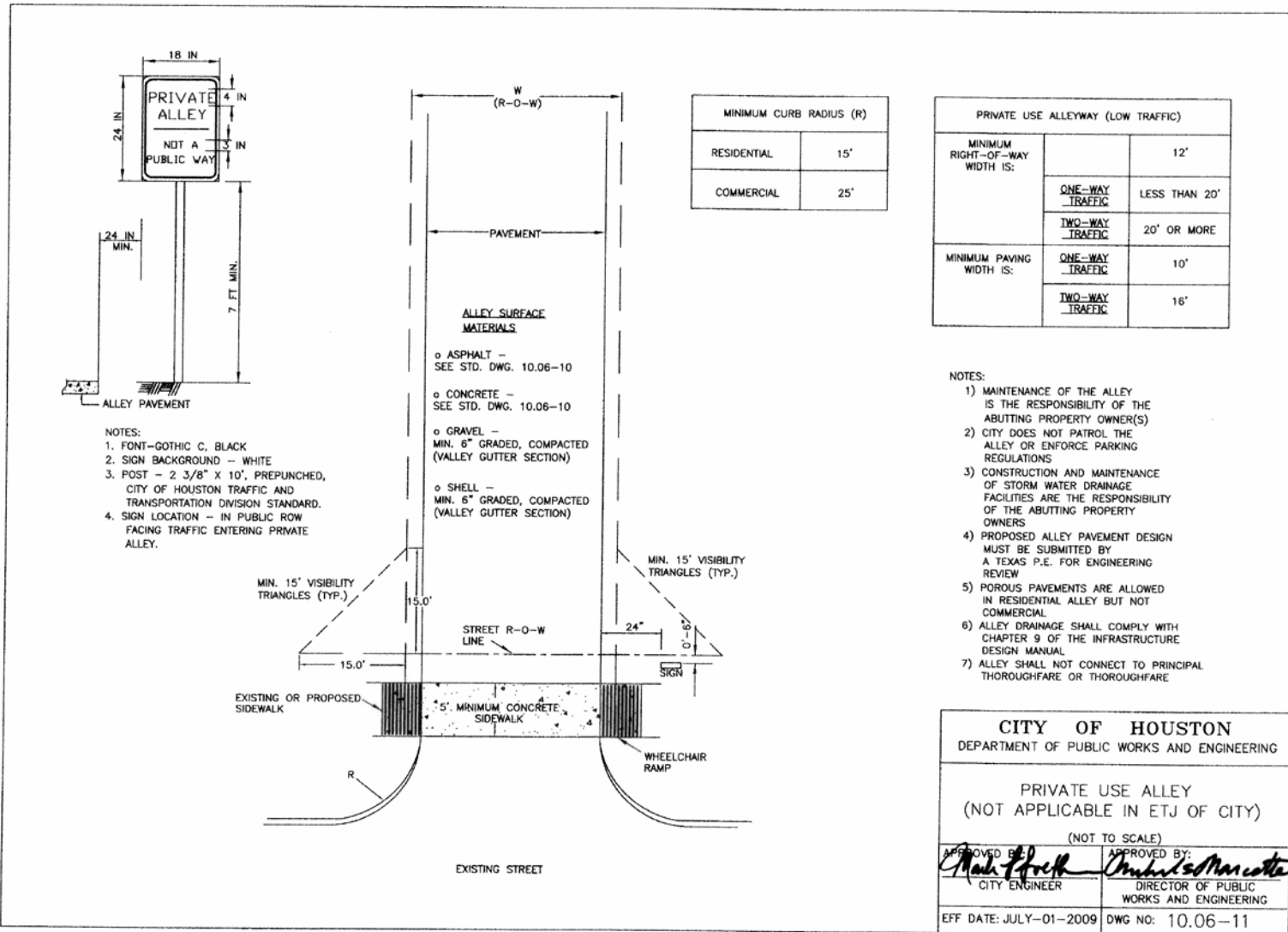

APPENDIX 2

CHAPTER 10

Appendix 2 presents a “Street Design Menu” with examples of optional roadway corridor sections that are a result of the 2009 City of Houston Mobility Planning Study. Figure 1 is provided to cross reference the street classifications in the Major Thoroughfare and Freeway Plan to the corridor sections within the City Mobility Plan. These corridor sections can be utilized for development of roadway systems within the City limit of Houston. These roadway sections are not applicable in the ETJ of the City. The tables identify the right-of-way requirements and element dimensions associated with each corridor section.

Each roadway corridor section is permissible under the Infrastructure Design Manual but requires the specific approval of the City Engineer prior to construction. While full right-of-way dedication may not be required under Chapter 42 of the City of Houston Code of Ordinances, it is expected that developer’s utilizing these alternative sections will make available the necessary public right-of-way dimensions at no cost to the City of Houston.

NOTES

1. Sidewalk dimensions shown are options. Minimum sidewalk dimension for Transit Street designations is six (6) feet and five (5) feet for all others.
2. TW – Tree Wells will be considered for use in lieu of a green space dimension where shown in Tables.

CITY MOBILITY PLAN (CMP)					MAJOR THOROUGHFARE AND FREEWAY PLAN (MTFP)				
MULTI MODAL CLASSIFICATION					EXISTING CLASSIFICATION				
Proposed ROW	Number of Lanes	Avg Daily Traffic Vol (vpd)	Design Speed (mph)	PRINCIPAL THOROUGHFARE	THOROUGHFARE	MAJOR COLLECTOR	COLLECTOR	LOCAL STREET	
				>5 miles >30,000 vpd Design Speed 45 mph Ex ROW: 60' - 400'	>3 miles >20,000 vpd Design Speed 45 mph Ex ROW: 50' - 210'	1 - 2 miles >5,000 vpd Design Speed 45 mph Ex ROW: 50' - 150'	1 - 2 miles >5,000 vpd Design Speed 45 mph Ex ROW: 50' - 150'	<1 mile <5,000 vpd Design Speed 35 mph Min 50'	
BOULEVARD									
Urban	100'-140'	4-8	15,000-50,000	45					
Suburban	100'-120'	2-6	500-50,000	45					
Transit	120'	4-6	1,500-30,000	45					
Industrial	100'-120'	4-6	15,000-50,000	45					
AVENUE									
Urban	80'-100'	2-4	1,500-30,000	45					
Suburban	80'-100'	2-4	1,000-20,000	45					
Transit	100'	2	1,500-15,000	45					
Industrial	80'-100'	3-5	5,000-35,000	45					
COUPLET									
STREET									
Urban	60'	2	1,000-10,000	35					
Suburban	60'	2	500-5,000	35					
LOCAL STREET									
Residential Main	60'-70'	2	≥1,500	35					
Residential High Density	55'-60'	2	350-750	35					
Residential Std Density	50'-65'	1+	250-350	35					

Indicates Shared Classification

Figure 1

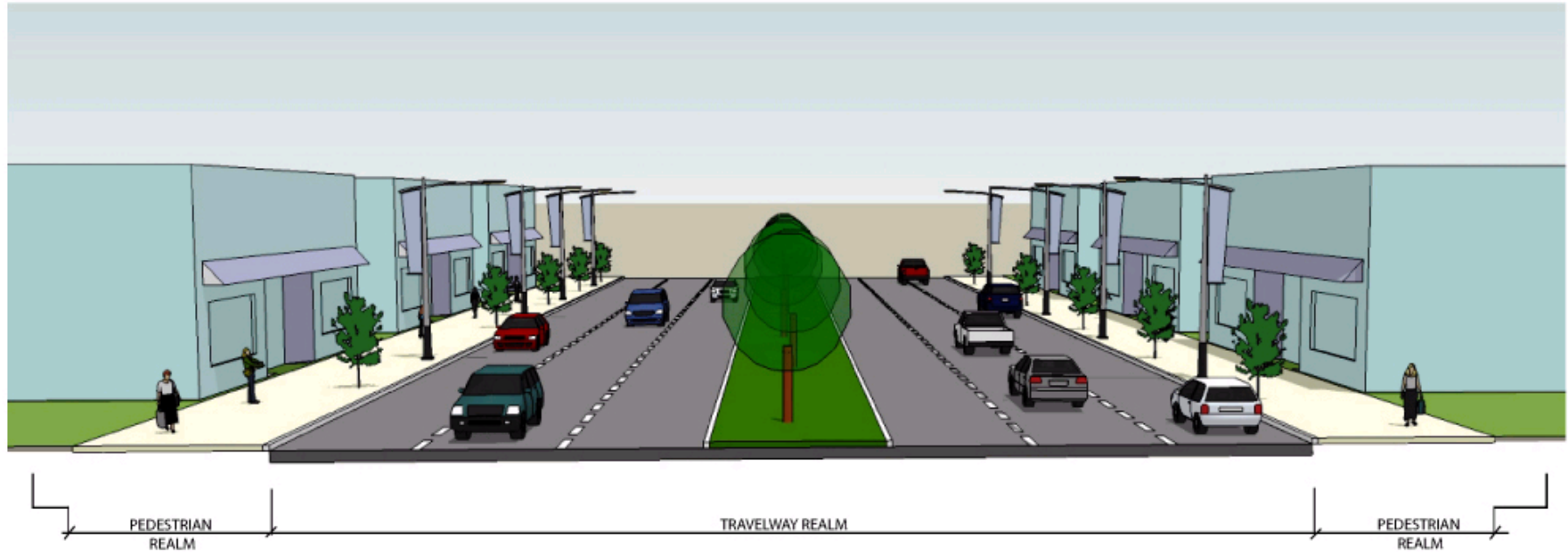

URBAN BOULEVARD DESIGNATION							
Minimum R.O.W. (feet)	PEDESTRIAN REALM		TRAVELWAY REALM				ADT (vpd)
	Sidewalk (feet)	Tree Well or Swale	On-Street Parking (feet)	Bike Lane (feet)	Median Width (feet)	Lane Widths (feet)	
100	16 x 2 = 32	TW	N/A	N/A	20	4 x 12 = 48	15,000-30,000
	18 x 2 = 36	TW	N/A	N/A	16	4 x 12 = 48	
	12 x 2 = 24	TW	N/A	6 x 2 = 12	16	4 x 12 = 48	
120	16 x 2 = 32	TW	N/A	N/A	16	6 x 12 = 72	15,000-40,000
	12 x 2 = 24	TW	N/A	N/A	24	6 x 12 = 72	
	10 x 2 = 20	TW	N/A	6 x 2 = 12	16	6 x 12 = 72	
140	10 x 2 = 20	TW	N/A	N/A	24	8 x 12 = 96	20,000-50,000

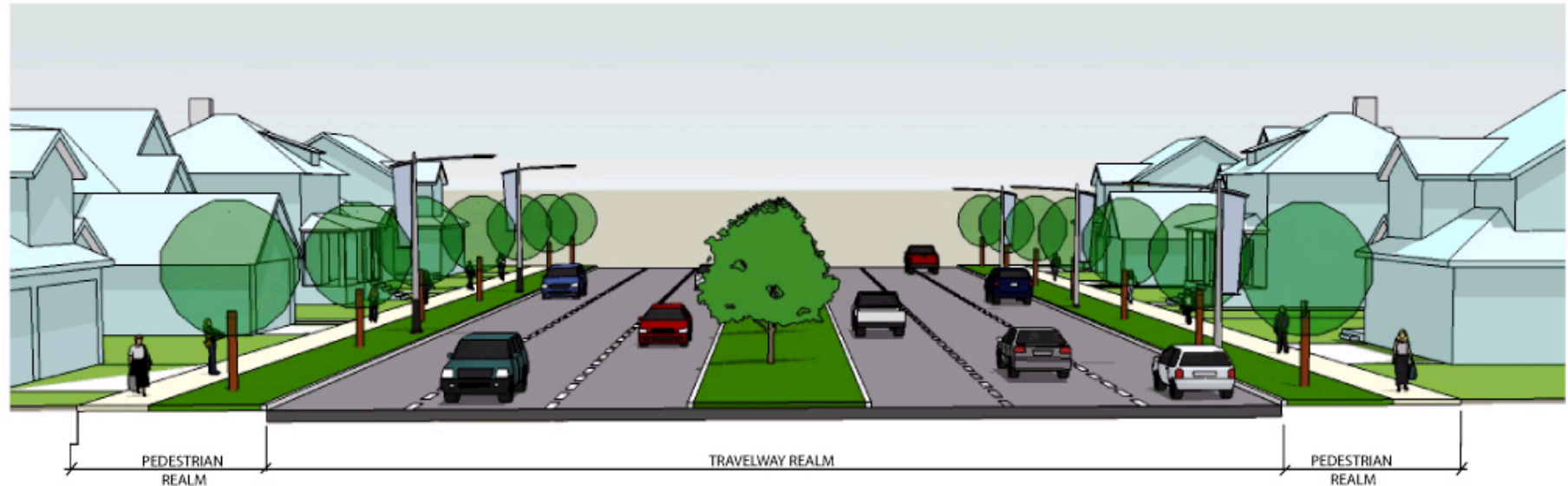

SUBURBAN BOULEVARD DESIGNATION							
Minimum R.O.W. (feet)	PEDESTRIAN REALM		TRAVELWAY REALM				ADT (vpd)
	Sidewalk (feet)	Tree Landscape or Swale (feet)	On-Street Parking (feet)	Bike Lane (feet)	Median Width (feet)	Lane Widths (feet)	
100	10 x 2 = 20	14 x 2 = 28	8 X 2 = 16	N/A	12	2 x 12 = 24	500-5,000
	5 x 2 = 10	10 x 2 = 20	N/A	N/A	20	4 x 12 = 48	20,000-35,000
	16 x 2 = 32	8 x 2 = 16	N/A	N/A	20	4 x 12 = 48	
120	10* x 2 = 20	8 x 2 = 16	N/A	5 x 2 = 10	18	4 x 12 = 48	1,500-15,000
	5 x 2 = 10	10 x 2 = 20	N/A	N/A	16	6 x 12 = 72	20,000-50,000
	14 x 2 = 28	6 x 2 = 12	N/A	N/A	20	6 x 12 = 72	

* Multi-Use Path along Center of Median, No abutting sidewalks

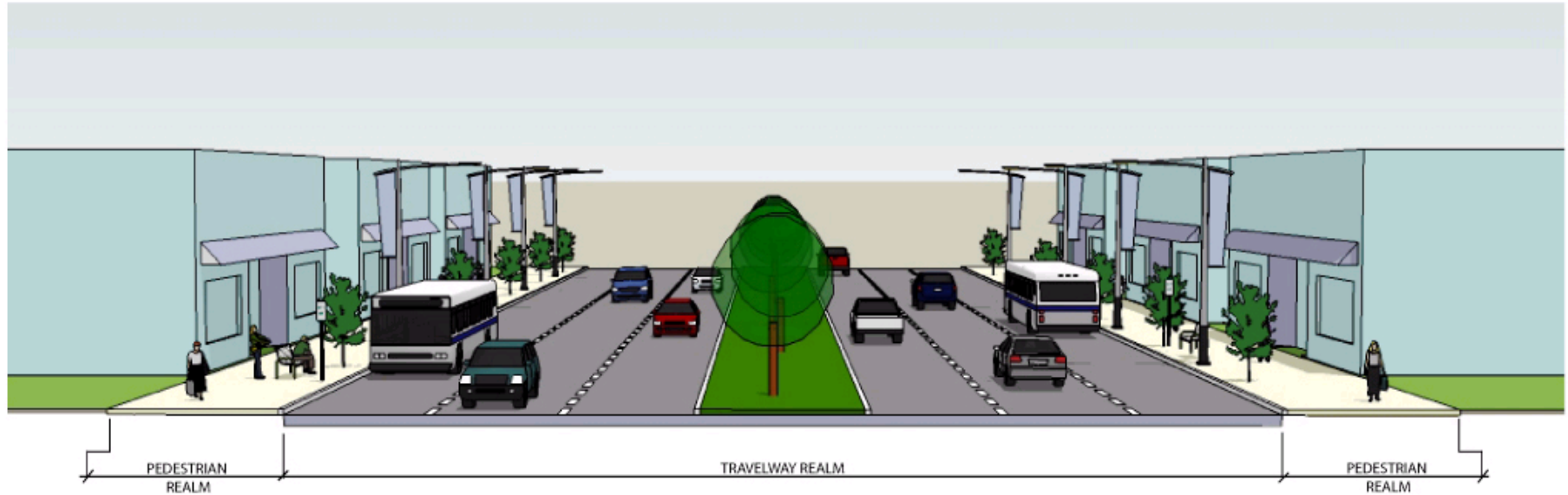

TRANSIT BOULEVARD DESIGNATION							
Minimum R.O.W. (feet)	PEDESTRIAN REALM		TRAVELWAY REALM				ADT (vpd)
	Sidewalk (feet)	Tree Well or Swale (feet)	On-Street Parking (feet)	Bike Lane (feet)	Median Width (feet)	Lane Widths (feet)	
110	17 x 2 = 34	TW	N/A	N/A	28	4 x 12 = 48	15,000--30,000
120	16 x 2 = 32	TW	N/A	6 x 2 = 12			
120	15 x 2 = 30	TW	N/A	N/A	16	4 x 12, + 2 x 13 = 74	15,000-30,000
125	15.5 x 2 = 31	TW	N/A	N/A	20		

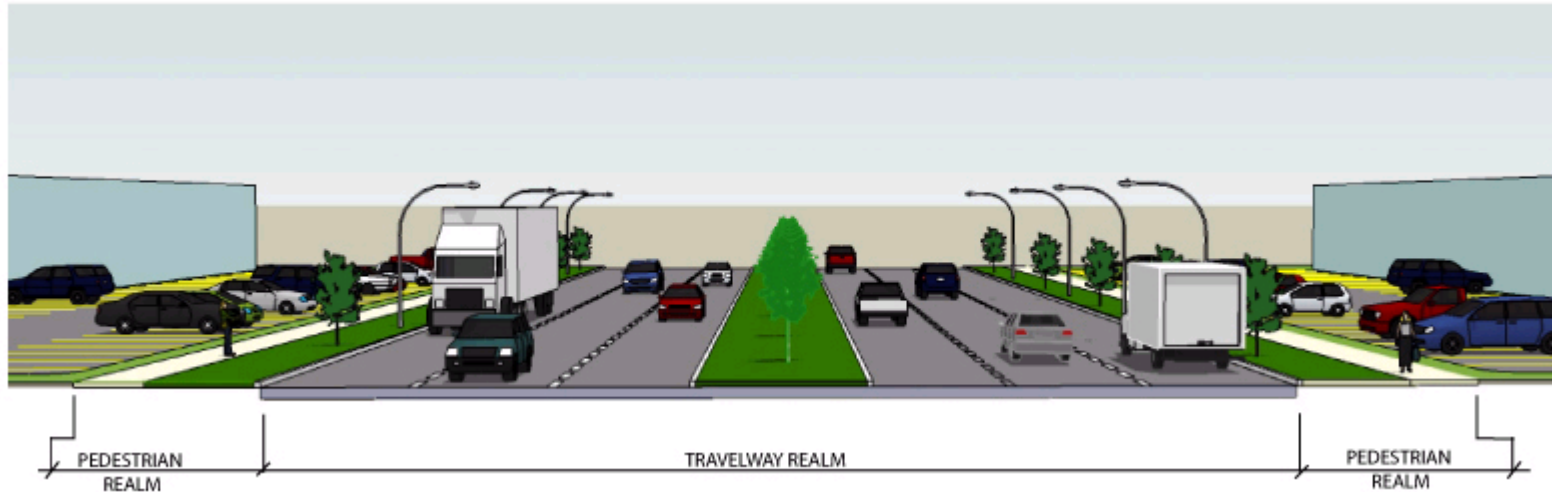

INDUSTRIAL BOULEVARD DESIGNATION							
Minimum R.O.W. (feet)	PEDESTRIAN REALM		TRAVELWAY REALM				ADT (vpd)
	Sidewalk (feet)	Tree Landscape or Swale (feet)	On-Street Parking (feet)	Bike Lane (feet)	Median Width (feet)	Lane Widths (feet)	
120	5 x 2 = 10	10 x 2 = 20	N/A	N/A	16	4 x 12, + 2 x 13 = 74	20,000--50,000
100	5 x 2 = 10	10 x 2 = 20	N/A	N/A	20	2 x 12, + 2 x 13 = 50	15,000--40,000

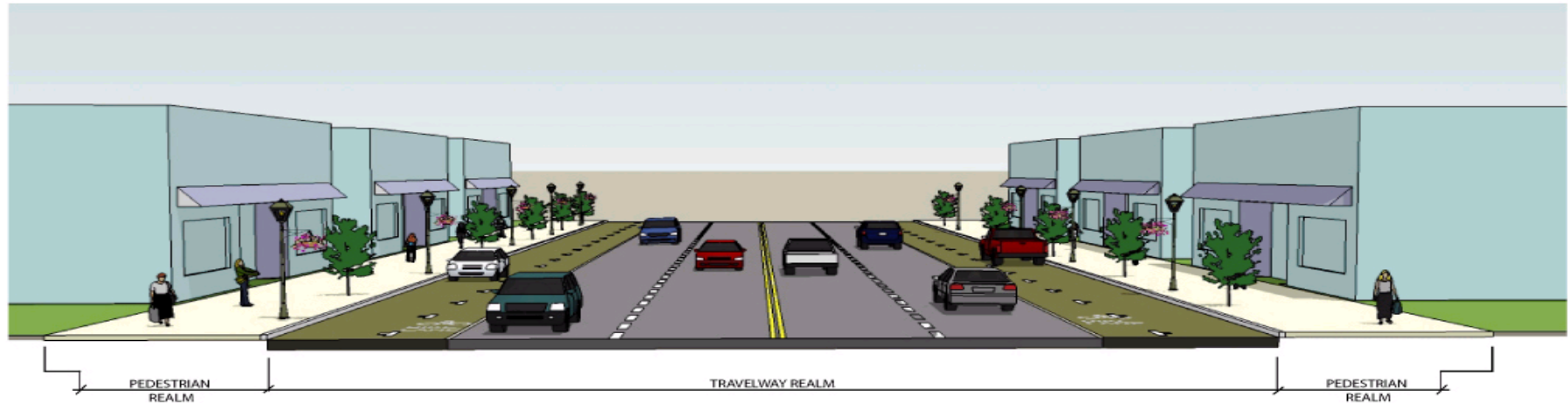

URBAN AVENUE DESIGNATION

Minimum R.O.W. (feet)	PEDESTRIAN REALM		TRAVELWAY REALM				ADT (vpd)
	Sidewalk (feet)	Tree Well or Swale (feet)	On-Street Parking (feet)	Bike Lane (feet)	Median Width (feet)	Lane Widths (feet)	
80	20 x 2 = 40	TW	8 x 2 = 16	N/A	N/A	2 x 12 = 24	1,500-15,000
	10 x 2 = 20	TW	18 x 2 = 36 *	N/A	N/A		
	15 x 2 = 30	TW	8 x 2 = 16	5 x 2 = 10	N/A		
	10 x 2 = 20	TW	18 x 2 = 36 *	N/A	N/A[AM1]		
	22 x 2 = 44	TW	N/A	6 x 2 = 12	N/A	2 x 12 + 1 x 14 (CLTL*)* = 38	5,000-20,000
	21 x 2 = 42	TW	N/A	N/A	N/A		
	13 x 2 = 26	TW	8 x 2 = 16	N/A	N/A		
	8 x 2 = 16	TW	8 x 2 = 16	5 x 2 = 10	N/A		
	15 x 2 = 30	TW	N/A	6 x 2 = 12	N/A		
	16 x 2 = 32	TW	N/A	N/A	N/A		
100	8 x 2 = 16	TW	8 x 2 = 16	N/A	N/A	4 x 12 = 48	10,000-30,000
	10 x 2 = 20	TW	N/A	6 x 2 = 12	N/A	4 x 12 = 48	
	13 x 2 = 26	TW	8 x 2 = 16	5 x 2 = 10	N/A	4 x 12 = 48	
100	20 x 2 = 40	TW	N/A	6 x 2 = 12	N/A	4 x 12 = 48	10,000-30,000

* Angle Parking

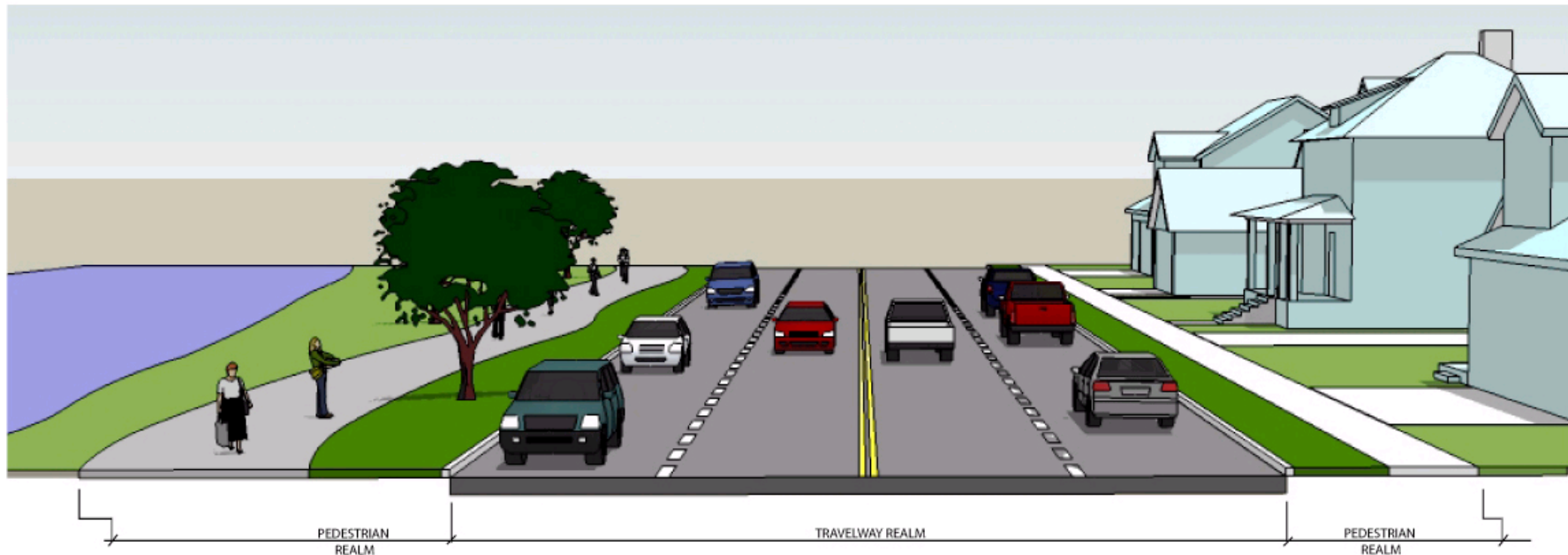

SUBURBAN AVENUE DESIGNATION

Minimum R.O.W. (feet)	PEDESTRIAN REALM		TRAVELWAY REALM				ADT (vpd)
	Sidewalk (feet)	Landscape Tree or Swale (feet)	On-Street Parking (feet)	Bike Lane (feet)	Median Width (feet)	Lane Widths (feet)	
80	10 x 2 = 20	10 x 2 = 20	8 x 2 = 16	N/A	N/A	2 x 12 = 24	1,000-10,000
	8 x 2 = 16	7 x 2 = 14	8 x 2 = 16	5 x 2 = 10	N/A		
	12 x 2 = 24	10 x 2 = 20	N/A	6 x 2 = 12	N/A		
	10 x 2 = 20	6 x 2 = 12	N/A	N/A	N/A	4 x 12 = 48	
	18 x 2 = 36	8 x 2 = 16	N/A	N/A	N/A		
5 x 2 = 10	4 x 2 = 8	N/A	6 x 2 = 12	N/A			
100	5 x 2 = 10	12 x 2 = 24	8 x 2 = 16	N/A	N/A	4 x 12 = 48	5,000-20,000
	5 x 2 = 10	14 x 2 = 28	N/A	6 x 2 = 12	N/A		

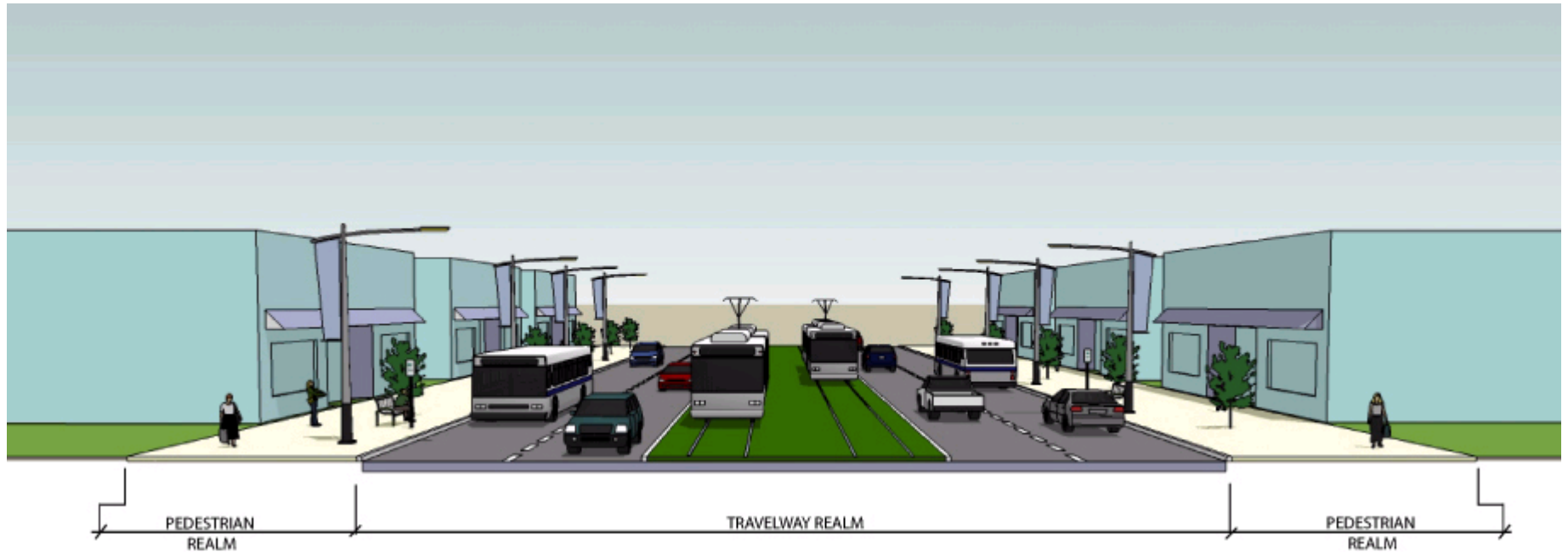

TRANSIT AVENUE DESIGNATION							
Minimum R.O.W. (feet)	PEDESTRIAN REALM		TRAVELWAY REALM				ADT (vpd)
	Sidewalk (feet)	Tree Well or Swale (feet)	On-Street Parking (feet)	Bike Lane (feet)	Median Width (feet)	Lane Widths (feet)	
100	18 x 2 = 36	TW	N/A	6 x 2 = 12	28	2 x 12 = 24	1,500-15,000
100	16 x 2 = 32	TW	8 x 2 = 16	N/A			

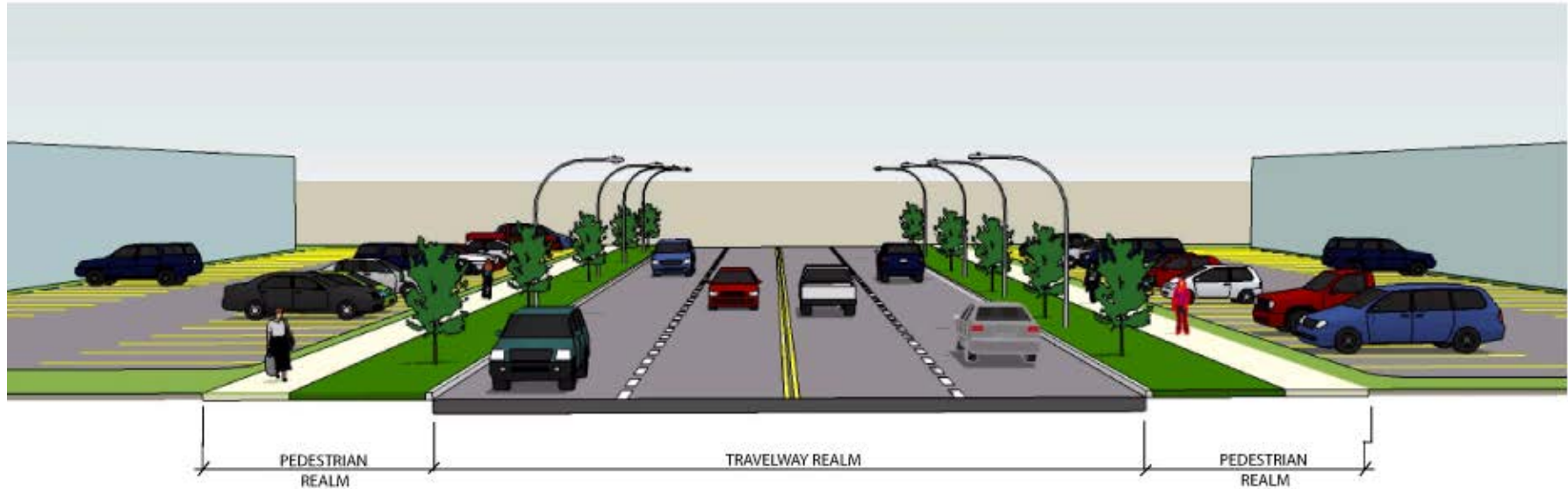

INDUSTRIAL AVENUE DESIGNATION

Minimum R.O.W. (feet)	PEDESTRIAN REALM		TRAVELWAY REALM				ADT (vpd)
	Sidewalk (feet)	Tree Landscape or Swale (feet)	On-Street Parking (feet)	Bike Lane (feet)	Median Width (feet)	Lane Widths (feet)	
80	5 x 2 = 10	10 x 2 = 20	N/A	N/A	N/A	2 x 12, + 2 x 13 = 50	10,000-25,000
	5 x 2 = 10	10 x 2 = 20	N/A	N/A	N/A	2 x 13, + 1 x 14 = 50	5,000-15,000
90	5 x 2 = 10	15 x 2 = 30	N/A	N/A	N/A	2 x 13 + 1 x 14 = 50	5,000-15,000
100	5 x 2 = 10	12 x 2 = 24	N/A	N/A	N/A	4 x 13 +, 1 x 14 = 66	10,000-35,000

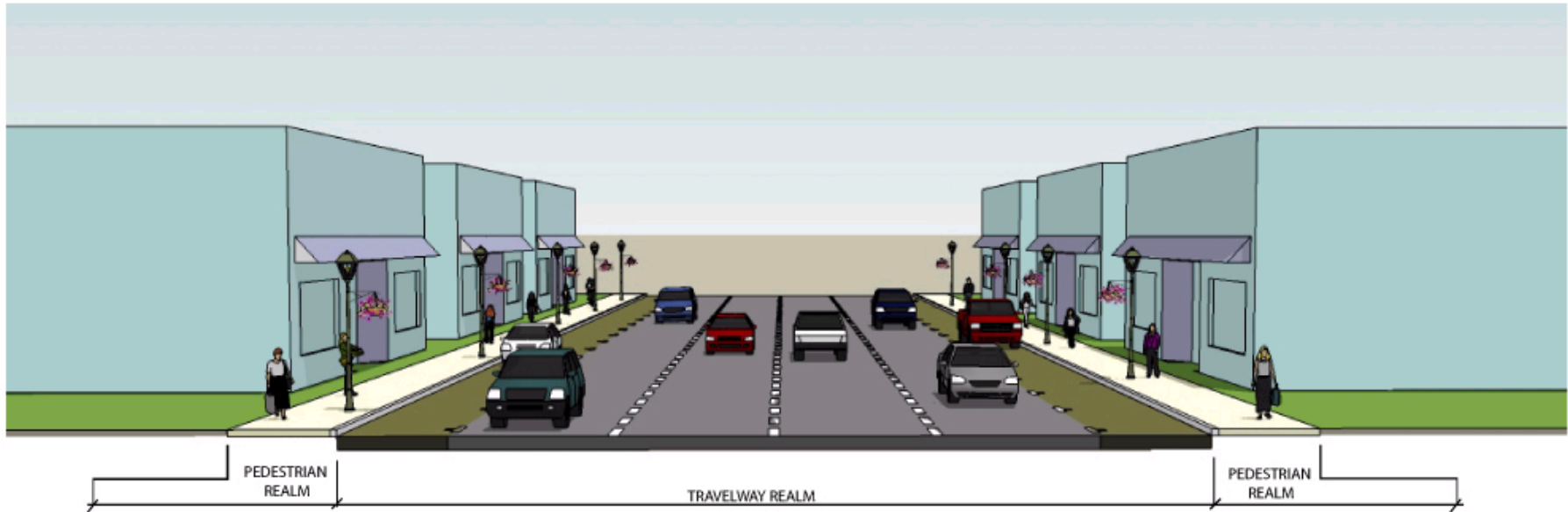

COUPLET DESIGNATION

Street Type	Minimum R.O.W. (feet)	PEDESTRIAN REALM		TRAVELWAY REALM			Lane Widths (feet)	ADT (vpd)
		Sidewalk (feet)	Tree Well or Swale (feet)	On-Street Parking (feet)	Bike Lane (feet)	Median Width (feet)		
2 Lane Couplet	60	20 x 2 = 40	TW	8 x 2 = 16	N/A	N/A	2 x 12 = 24	1,000-10,000
	18	20 x 2 = 40	TW	N/A	N/A	N/A		
3 Lane Couple	80	14 x 2 = 28	TW	8 x 2 = 16	N/A	N/A	3 x 12 = 36	1,500-15,000
		22 x 2 = 44	TW	N/A	N/A	N/A		
4 Lane Couplet	80	8 x 2 = 16	TW	8 x 2 = 16	N/A	N/A	4 x 12 = 48	5,000-20,000
		16 x 2 = 32	TW	N/A	N/A	N/A		
5 Lane Couplet	80	10 x 2 = 20	TW	N/A	N/A	N/A	5 x 12 = 60	10,000-25,000
	100	12 x 2 = 24	TW	8 x 2 = 16	N/A	N/A		



URBAN STREET DESIGNATION						
Minimum R.O.W. (feet)	PEDESTRIAN REALM		TRAVELWAY REALM			ADT (vpd)
	Sidewalk (feet)	Tree Well or Swale (feet)	On-Street Parking (feet)	Bike Lane (feet)	Lane Widths (feet)	
60	18 x 2 = 36	TW	N/A	N/A	2 x 12 = 24	1,000 – 10,000
	10 x 2 = 20	TW	8 x 2 = 16	N/A		
	12 x 2 = 24	TW	N/A	N/A		
	12 x 2 = 24	TW	N/A	6 x 2 = 12 _[AM2]		

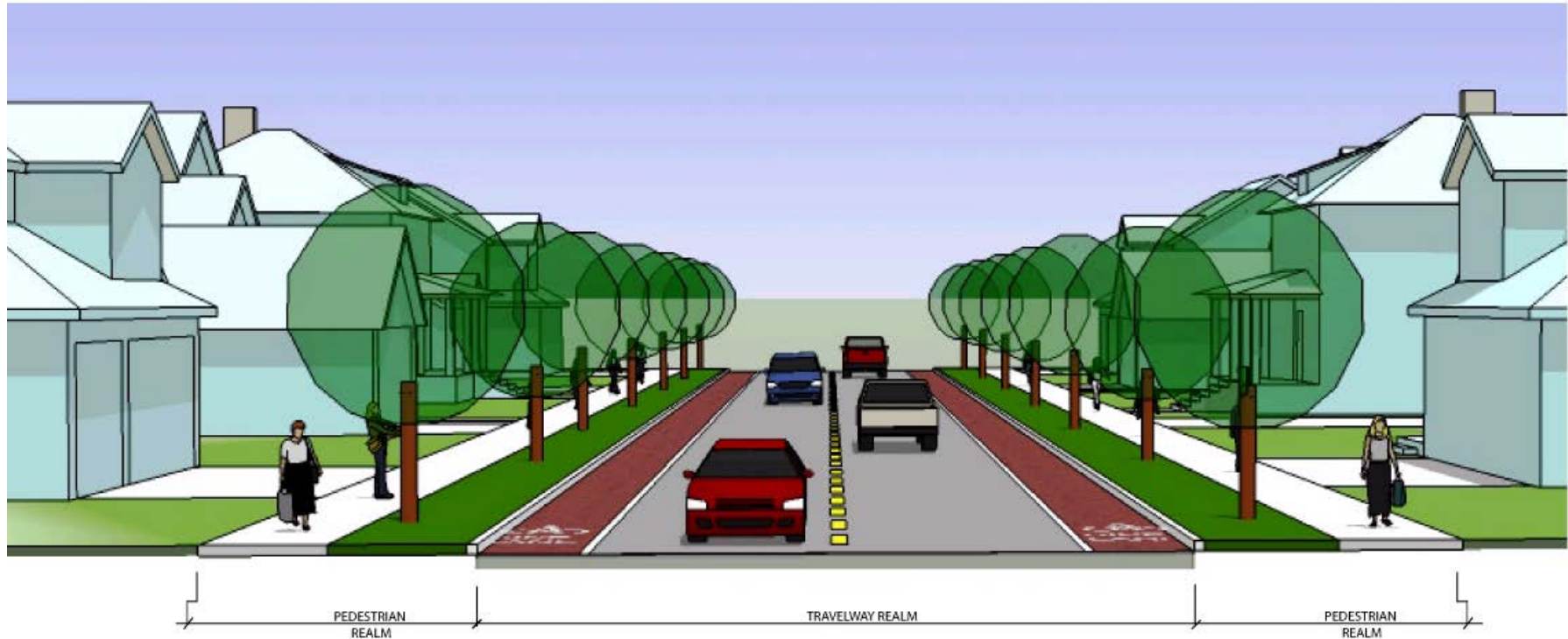

SUBURBAN STREET DESIGNATION						
Minimum R.O.W. (feet)	PEDESTRIAN REALM		TRAVELWAY REALM			ADT (vpd)
	Sidewalk (feet)	Landscape Tree or Swale (feet)	On-Street Parking (feet)	Bike Lane (feet)	Lane Widths (feet)	
60	5 x 2 = 10	13 x 2 = 26	N/A	N/A	2 x 12 = 24	500 – 5,000
	5 x 2 = 10	5 x 2 = 10	8 x 2 = 16	N/A		
	5 x 2 = 10	7 x 2 = 14	N/A	6 x 2 = 12		
	5 x 2 = 10	10 x 2 = 20	N/A	N/A	2 x 12 + 6' (Median) = 30	

City of Houston

Design Manual

Chapter 11

**GEOTECHNICAL AND ENVIRONMENTAL
REQUIREMENTS**

Chapter 11

GEOTECHNICAL AND ENVIRONMENTAL REQUIREMENTS

11.01 CHAPTER INCLUDES

- A. This chapter includes minimum Geotechnical Investigation Requirements for projects inside the city limits of Houston and within its extra territorial jurisdiction (ETJ).
- B. This chapter also includes minimum Phase I Environmental Site Assessment (ESA I) and Phase II Environmental Site Assessment (ESA II) Requirements for land involved in the City of Houston real estate transactions, interdepartmental transfers, ETJ, and rights-of-way which will be involved in the construction projects.

11.02 REFERENCES

The latest versions of the following references shall be reviewed in conjunction with this chapter:

- A. The American Association of State Highway and Transportation Officials (AASHTO) Guide for Design of Pavement Structures.
- B. The American Society for Testing and Materials (ASTM) standard test methods and environmental site assessments processes.
- C. The City of Houston's Standard Construction Specifications.
- D. The Harris County Flood Control District's (HCFCD) Geotechnical Investigation Guidelines.
- E. The Houston Geological Society (HGS) requirements for conducting fault studies.
- F. Rules and regulations published by the Occupational Safety and Health Administration (OSHA).
- G. Rules and regulations published by the Texas Commission on Environmental Quality (TCEQ).
- H. Rules and regulations published by the Texas Department of Licensing and Regulation (TDLR) including Texas Administrative Code (TAC) Chapter 76 – Water Well Drillers and Water Well Pump Installers.
- I. Rules and regulations published by the Texas Board of Professional Engineers (TBPE).
- J. Geotechnical Manual issued by the Texas Department of Transportation (TxDOT).

- K. The Texas Manual on Uniform Traffic Control Devices (TMUTCD).

11.03 DEFINITIONS

- A. Engineer of Record – Project Civil Design Consultant
- B. Project Manager – An authorized representative of the City of Houston who manages the project or the Engineer of Record for private development.
- C. Geotechnical Consultant – A consultant who is practicing in the field of Geotechnical Engineering in the State of Texas and has a valid status with the TBPE.
- D. Licensed Engineer – An engineer currently licensed to practice engineering in the State of Texas and is in good standing with the TBPE.
- E. Licensed Geoscientist – A geoscientist currently licensed to practice geosciences in the State of Texas and is in good standing with the Texas Board of Professional Geoscientists.

11.04 INTRODUCTION TO GEOTECHNICAL REQUIREMENTS

- A. A detailed Geotechnical Investigation (by borings) is required for the completion of the design of the proposed facilities. Data from the earlier project design activities shall be incorporated if it is sufficient and reliable for the current project as determined by the City's Project Manager in consultation with the Geotechnical Consultant.
- B. The purpose of the Geotechnical Requirements is to outline the minimum recommended procedures for implementing a uniform approach for the preparation of the Geotechnical Investigation Reports on the City of Houston projects including its ETJ.
- C. The scope of the Geotechnical Investigation may need to be expanded or modified on a case by case basis as determined necessary and appropriate by the City's Project Manager. It is not the intent of the Geotechnical Requirements to specify methods or scope of Geotechnical Investigation for individual projects, or to supplant the judgment of the Licensed Engineer. No provision in these requirements should be construed to constitute a statute, ordinance, or regulation, unless stipulated elsewhere.
- D. In the event that any part of the Geotechnical Requirements should be found to be in conflict with laws or regulations of competent jurisdiction or ruled to be invalid by a court authority of competent jurisdiction, the remainder of the Geotechnical Requirements shall remain in full force and effect, and the conflicting section or item shall be deleted or revised as required and as determined necessary by the City of Houston.
- E. These Geotechnical Requirements are not applicable when another agency (like the HCFCD) will maintain the facility, or the funding source (like the TxDOT) has specific requirements that must be met in order to receive funding for the project. In which case, another agency's requirements shall be applicable.

- F. Not all of the information in this chapter will be applicable to every project, but the investigative scope should be consistent with the sensitivity of the intended use and the physical constraints of the project.

11.05 ENGINEER OF RECORD'S EFFORTS

- A. The Engineer of Record, at the proposal stage of the project, shall work with the Geotechnical Consultant to develop the proper scope of the project.
- B. The Engineer of Record shall inform the Geotechnical Consultant for any changes in the project related to Geotechnical Investigation as soon as possible.
- C. The Engineer of Record shall assist the Geotechnical Consultant in obtaining required permits for drilling, if requested by the Geotechnical Consultant.
- D. The Engineer of Record shall provide survey information of the borings (after drilling) to the Geotechnical Consultant to be used in the Geotechnical Investigation Report.
- E. The Engineer of Record shall provide a base map using engineering scale (showing the alignments and/or structures) of the project to the Geotechnical Consultant that can be used as a Plan of Borings.
- F. The Engineer of Record shall verify the Geotechnical Investigation performed by the Geotechnical Consultant for the conformance with the Geotechnical Requirements and for conformance with project specific conditions and design requirements.
- G. The Engineer of Record shall review the Geotechnical Investigation Report and attach their review comments with the Geotechnical report prior to submittal to the City of Houston.

11.06 GEOTECHNICAL CONSULTANT'S EFFORTS

- A. The Geotechnical Consultant shall confirm with the Engineer of Record that the proper scope of the project is proposed in the proposal.
- B. The Geotechnical Consultant shall include the project description, location, and Key Map Number(s) in the geotechnical proposal. Also, a proposed Plan of Boring(s) may be included in the geotechnical proposal, if available.
- C. The Geotechnical Consultant has a responsibility to obtain the latest information of the project from the Engineer of Record before starting the field investigation. If modifications are required in the original Geotechnical Investigation scope, then the City's Project Manager shall be contacted by Engineer of Record before commencement of the field investigation.

- D. The planning of field investigation, laboratory testing, engineering analyses, and close supervision of the work shall be performed by a Licensed Engineer of the Geotechnical Consultant who has experience in this type of work.
- E. All Geotechnical Laboratory tests shall be conducted by the Geotechnical Consultant with current accreditation by the American Association of Laboratory Accreditation (A2LA) or any other accreditation agency approved by the City of Houston.
- F. The Geotechnical Consultant is responsible for adhering to all pertinent federal, state, and local regulations and laws throughout the Geotechnical Investigation.

11.07 SITE ACCESS

- A. When the Geotechnical Investigation will be within the public right-of-way and easement, the Geotechnical Consultant shall obtain necessary permits and arrange for access to boring locations from the appropriate governmental agency.
- B. When the Geotechnical Investigation will require entry onto a private property, the Geotechnical Consultant may require assistance from the Engineer of Record in obtaining permission to enter in the private property.
- C. It shall be the ultimate responsibility of the Geotechnical Consultant to ensure necessary permits are obtained before commencement of drilling for the project.

11.08 TRAFFIC CONTROL

- A. The Geotechnical Consultant is responsible for the safety of drilling work area during field operations, including traffic control commensurate with the traffic while working in the street right-of-way.
- B. Traffic control shall be in accordance with the TMUTCD.
- C. Provide a Certified Flagman to control movement of vehicular and pedestrian traffic when field investigation encroaches on public traffic lanes. Provide a Uniformed Peace Officer for work along major thoroughfares and at signalized intersections.

11.09 FAULT INVESTIGATION

- A. As a part of the Geotechnical Investigation, geologic fault maps, aerial photographs, and literature available in Geotechnical Consultant's library shall be reviewed to evaluate the potential for known active faults that may impact the project.
- B. If a review of available existing information suggests that a known fault may impact the project, a Phase I Geological Fault Study shall be performed as defined by the current HGS guidelines.

- C. At a minimum, the Phase I Geological Fault Study shall consist of a detailed literature review, a remote sensing study with examination of historical aerial photographs (including LiDAR and false color infra-red imagery), a study of subsurface geologic structure maps, topographic maps, and a detailed field reconnaissance.
- D. If the project is part of a larger tract for which a Phase I, II, or III Geological Fault Study is available, the results of the study on the larger tract may satisfy this requirement. In this circumstance, the necessity of a Phase I Geological Fault Study shall be decided by the City's Project Manager.
- E. The Phase I Geologic Fault Study may also be conducted on areas where no faults appear in published literature and maps but when there is evidence that surface faults and possibly blind faults could exist in that area. In this circumstance, the necessity of a Phase I Geological Fault Study shall be decided by the City's Project Manager.
- F. When required, the Phase I Geological Fault Study shall be performed as a separate study to supplement the Geotechnical Investigation.
- G. The entire Phase I Geological Fault Study, when required, shall be performed by a licensed geoscientist or a Licensed Engineer in the State of Texas who has substantial experience and training in investigating surface faults in the Greater Houston area. At the least, such experience and training should include a general knowledge of the location of known surface faults in the Gulf Coast, an understanding of fault mechanics, and a familiarity with the many subtle ways that surface faults manifest themselves.

Additional criteria that shall be met by a licensed geoscientist or a licensed engineer are as follows:

1. Ability to recognize surface faults on aerial images and topographic maps.
 2. Ability to distinguish surface faults from other natural and man-made features.
 3. Ability to distinguish ground deformation caused by expansive clay soils from that caused by active faults.
 4. Ability to determine and map the width of the zone of disturbed ground along an active fault.
- H. At a minimum, the Phase I Geologic Fault Study shall determine the likelihood of a surface fault impacting the project. If a fault is determined to be present at the project, it should be delineated on a map. In the event that the fault is clearly visible at the Earth's surface, the width of the fault's associated deformation zone should be determined and mapped. The mapping shall be considered as an additional study.

- I. When a fault is not clearly visible at the surface, its delineation and mapping may require an investigation employing Phase II and III subsurface methods. In this circumstance, the necessity of the Phase II or Phase III shall be decided by the City's Project Manager.
- J. The qualifications, including specific geologic fault project experience, of the professional performing the Phase I Geological Fault Study shall be included in the fault report.
- K. The draft report of the Phase I Geological Fault Study report shall be submitted before the final report.
- L. The final report of the Phase I Geological Fault Study shall be signed and may be stamped by the professional conducting the study.
- M. The Phase I Geological Fault Study Report, when required, shall be included in the appendix of the Geotechnical Investigation Report.

11.10 GENERAL INVESTIGATION

- A. Some of the facilities in which Geotechnical Investigation may be required are given below:
 - 1. Above ground water storage tanks and associated structures.
 - 2. Bridges (roadway, pedestrian, and pipe support).
 - 3. Clarifiers and associated structures.
 - 4. Detention/Retention basins.
 - 5. Lift stations and associated structures.
 - 6. Open channels.
 - 7. Retaining walls.
 - 8. Street pavement.
 - 9. Traffic signal foundations.
 - 10. Tunnels.
 - 11. Underground utilities using open cut or trenchless methods.
- B. Geotechnical Investigation may also be required for:
 - 1. Construction that could affect the integrity of adjacent structures (with the exception of interconnections such as service connections and meter vault installations).

2. Proposed construction work near ground slopes, such as drainage channels or natural waterway.

11.11 PROTECTION OF UNDERGROUND UTILITIES AND STRUCTURES

- A. On the public rights-of-way and easements, it shall be the responsibility of the Geotechnical Consultant to have existing utility lines marked and boring locations cleared prior to drilling.
- B. On private properties, it shall be necessary to employ the property owner's assistance to estimate the locations of the underground utilities and structures.
- C. Drilling shall not begin until clearance has been provided or notification that all underground utility lines are marked has been received by the Geotechnical Consultant.
- D. If there is any reason to believe that an underground facility exists in an area to be drilled, and its location cannot be determined with reasonable accuracy, then that boring shall be moved from the area of concern.

11.12 FIELD INVESTIGATION NOTIFICATIONS

- A. The City's Project Manager shall be informed (via email or fax) about the start date of drilling approximately 48 hours prior to beginning drilling.
- B. If any unusual conditions are encountered during the field investigation (e.g., signs of contamination in the boring, cavity, loose or soft soils at the bottom of the planned boring depth, etc.), then the City's Project Manager shall immediately be informed.

11.13 FIELD INVESTIGATION

- A. The field logging of the soil samples shall be performed by an experienced soils technician of the Geotechnical Consultant.
- B. For the proposed open cut utility construction, the borings shall be drilled along or as close as possible to the center line of the alignment.
- C. For the proposed trenchless construction, the borings shall be drilled outside the planned utility alignment but within 20 feet of the centerline of the alignment.
- D. Soil Sample Methods and Intervals:
 1. Undisturbed cohesive soils samples should be recovered by using a thin-walled tube sampler in general accordance with ASTM D1587. For granular soils, Split-Barrel samplers should be used in general accordance with ASTM D1586.

2. Continuous soil sampling shall be performed at about 2-foot depth intervals to a minimum depth of about 20 feet of the borings and at about 5-foot interval thereafter to the termination depth of borings with the exception for bridge, retaining wall, lift station, and tunnel borings. If the boring depth is less than 20 feet, then continuous sampling shall be performed to the termination depth of the boring.
3. If a soil boring for bridge or retaining wall is within the TxDOT right-of-way, then the current TxDOT guidelines shall be followed including performing Texas Cone Penetration (TCP) testing.
4. If a soil boring for bridge or retaining wall is outside the TxDOT right-of-way, then the TCP testing is not required. However, TxDOT sampling interval guidelines shall be followed.
5. For lift stations, continuous soil sampling shall be performed at about 2-foot depth intervals throughout the entire depth of boring.
6. For tunnels, continuous soil sampling shall be performed from one bore diameter (or minimum of 6 feet) above the bore crown to one bore diameter (or minimum of 6 feet) below the bore invert level and at about 5-foot intervals in the remainder of the boring.
7. If unusual soils are encountered (e.g., loose or soft soils, etc) after the depth of 20 feet, then the intermittent soil sampling shall be changed to continuous soil sampling through the anomalous layer.
8. If the last planned sample is sand, an additional 5 feet shall be drilled.
9. Additional samples shall be obtained at strata change.

E. Boring Spacing

1. Soil borings shall be conducted in order to obtain sufficient information about the subsurface soil stratigraphy and water level conditions.
2. The recommended boring spacing is given in Table 11.1 (Page 11-9), unless waived by the City's Project Manager in writing.
3. For geotechnical features that are not mentioned in Table 11.1, the City's Project Manager shall be contacted.
4. Based on the reliability of soil information available to the City of Houston from the previous project design activities, the recommended boring spacing may be modified by the City's Project Manager in consultation with the Geotechnical Consultant.

F. Boring Depth

1. The minimum boring depths are given in Table 11.1, unless waived by the City’s Project Manager in writing.
2. For geotechnical features that are not mentioned in Table 11.1, the City’s Project Manager should be contacted.
3. Boring depth shall be increased by the Geotechnical Consultant if unusual soil conditions are encountered during field investigation (e.g., loose or soft soil at the bottom of the planned boring depth, etc).
4. The depth of borings for paving in conjunction with utility work is governed by utility requirements.

Table 11.1

BORING SPACING AND DEPTH

Project Type	Approximate Spacing	Minimum Depth
FACILITIES		
Above Ground Water Storage Tank	Per American Concrete Institute requirements.	
Lift Station (Less than 30-foot diameter)	At least one (1) soil boring within the footprint.	Proposed Lift Station depth plus greater of the following: <ul style="list-style-type: none"> ○ Width/diameter of lift station, or ○ 0.75 times the depth of the lift station.
Lift Station (30-foot or larger diameter)	One (1) boring at the center and add borings around the periphery at minimum 50-foot spacing.	
DRAINAGE		
Detention / Retention Basin	The HCFCD guidelines should be followed.	
Open Channel	The HCFCD guidelines should be followed.	
Table continued on next page		

Table 11.1 (continued)

Project Type	Approximate Spacing	Minimum Depth
UNDERGROUND UTILITIES		
Open Cut	Minimum distance of 500 feet.	<ul style="list-style-type: none"> ○ Trench depth plus five feet for trenches up to 10-foot deep. ○ Trench depth plus ten feet for trenches greater than 10-foot to 25-foot deep. ○ One and one half times the trench depth for trenches greater than 25-foot deep.
Augered	Minimum distance of 500 feet.	5-foot below the proposed invert level.
Tunnels and Microtunnels	Minimum distance of 500 feet.	Minimum one tunnel diameter or 15-foot below the proposed invert level (whichever is greater)
Shafts for Tunnels	Each Location.	Boring shall extend 1.5 times the shaft diameter below the bottom of the shaft but not less than 30 feet.
STREET & BRIDGE		
Pavement (Street)	Minimum distance of 500 feet.	10 feet.
Pedestrian and Pipe Bridge	Each side of drainage channel. (no more than 300-foot apart)	40 feet below the bottom of drainage channel.
Retaining Walls	The TxDOT guidelines should be followed.	
Roadway Bridge	The TxDOT guidelines should be followed.	
Traffic Signal Foundation	Each location.	20 feet.
OTHER		
Discretion of Geotechnical Engineer, Engineer of Record, and the City of Houston.		

G. Piezometers

1. Piezometers may be included in the scope of the Geotechnical Investigation if the project includes any of the following:
 - a. Excavation exceeding 15 feet in depth.
 - b. Crossing underneath a major drainage channel.
 - c. Crossing underneath a major TxDOT or the Harris County Toll Road Authority corridor.
 - d. Tunneling (hand or Tunnel Boring Machine) or Microtunneling installation for an extended length.
2. Piezometers shall be installed in accordance with the applicable rules and regulations of TDLR.
3. A minimum of two water level readings are required on each piezometer. The Geotechnical Consultant shall read water levels at 24 hours and 30 days after the installation of the piezometer, unless otherwise approved by the City's Project Manager.
4. For utility lines, spacing between piezometers shall be no greater than 2,500 feet in any direction.
5. One piezometer shall be installed within the footprint of a proposed deep structure, such as wet well or access shaft.
6. The Piezometer Installation Report (as shown on Figure 11.1) shall be included in the Geotechnical Investigation Report.

11.14 SITE RESTORATION

- A. The Geotechnical Consultant shall be responsible for clean up and site restoration upon completion of the field investigation.
- B. If for any reason the borehole must remain open, then appropriate measures shall be taken by the Geotechnical Consultant to protect the safety of the public.
- C. Plugging of Piezometer(s).
 1. The Geotechnical Consultant shall plug piezometer(s) installed for the project in accordance with the TDLR (Chapter 76 of TAC) soon after measuring 30-day water level readings. A copy of Piezometer Installation and Plugging Reports (submitted to the TDLR) shall be included in the Geotechnical Investigation Report.

D. Backfilling of Borings.

1. All borings under the existing or proposed pavement shall be backfilled with cement bentonite grout using the tremie method.
2. In unpaved areas where boring depth exceeds 10 feet (or if free water is encountered) boreholes shall be backfilled with cement bentonite grout using the tremie method. For depths of 10 feet or less, soil backfill tamped into the borehole is acceptable.
3. Boreholes in known contaminated areas, or in which contamination otherwise has been detected, shall be backfilled with cement-bentonite or non-shrink grout using tremie method.

E. Restoration of Pavement Cores.

1. Boreholes or cored pavements shall be restored for the full depth of pavement using cold patch in asphalt paved areas and ready-mix concrete in concrete paved areas. Larger penetrations shall be repaired following the current City of Houston guidelines.
2. The pavement shall not be restored until the borehole grout has taken initial set to allow for any settlement or shrinkage of the grout.

11.15 SURVEY REQUIREMENTS

- A. The locations and elevations of boreholes and piezometers shall be surveyed by the Engineer of Record or another member of the project team.
- B. The elevation and coordinates shall be shown on boring and piezometer logs by the Geotechnical Consultant.
- C. The station and offset of boreholes and piezometers may also be shown on boring and piezometer logs (in addition to coordinates) by the Geotechnical Consultant.

11.16 LABORATORY TESTING

- A. The purposes of the laboratory testing are to define the soil classification, soil stratigraphy, and the relevant engineering properties of the soils.
- B. The laboratory tests shall be performed in general accordance with the latest revision of the ASTM standards.
- C. The laboratory tests may include but not limited to the following:
 1. ASTM D2487 – Standard Practice for Classification of Soils for Engineering Purposes (Unified Soil Classification System)

2. ASTM D4318 – Standard Test Methods for Liquid Limit, Plastic Limit, and Plasticity Index of Soils
 3. ASTM D1140 – Standard Test Methods for Amount of Material in Soils Finer Than the No. 200 (75- μ m) Sieve
 4. ASTM D422 – Standard Test Method for Particle-Size Analysis of Soils
 5. ASTM D2216 – Standard Test Methods for Laboratory Determination of Water (Moisture) Content of Soil and Rock by Mass
 6. ASTM D2166 – Standard Test Method for Unconfined Compressive Strength of Cohesive Soil
 7. ASTM D2850 – Standard Test Method for Unconsolidated-Undrained Triaxial Compression Test on Cohesive Soils
 8. ASTM D1883 – Standard Test Method for CBR (California Bearing Ratio) of Laboratory-Compacted Soils
- D. The selection of appropriate laboratory tests beyond the above tests is left to the discretion of the Geotechnical Consultant in consultation with the City's Project Manager.
- E. To assist in properly classifying the soils in general accordance with ASTM D2487, the laboratory testing program shall include a minimum of one set of Liquid and Plastic Limits (ASTM D4318) and Percent Passing Number 200 Sieve (ASTM D1140) tests on a representative cohesive soil sample in each boring.
- F. The water content test (ASTM D2216) shall be performed on all cohesive soil samples to determine the moisture profile.
- G. The Unconfined Compression Strength test (ASTM D2166) shall not be performed on a soil sample containing seams or slickensides.
- H. If the invert level of the utility is greater than 5 feet, a minimum of one Unconsolidated-Undrained Triaxial test (ASTM D2850) shall be performed on a representative cohesive soil sample in each boring.
- I. If performing the CBR test (ASTM D1883) for paving projects, the Geotechnical Consultant shall also perform ASTM D4318 and ASTM D1140 tests on the CBR sample in order to properly classify the CBR sample. For subgrade soils, the CBR test shall be a three (3) point test.
- J. Aggressivity tests (Sulfates, Chlorides, pH, and Electric Resistivity) shall be performed on soil and water samples on projects where metallic pipes are used.

- K. All the test results shall be summarized in the report in a table format. The Geotechnical Consultant shall include the summary of the test results on the most updated template format, as provided by the City of Houston (as shown on Figure 11.2).

11.17 BORING LOG FORMAT

- A. The Geotechnical Consultant shall submit the boring log on the most updated template format, as provided by the City of Houston (as shown on Figure 11.3).
- B. The City of Houston project number shall be written on all boring logs.
- C. Any test data that is not included in boring log shall be reported separately in general accordance with the reporting guidelines mentioned in the ASTM standard of that test.

11.18 BORING LOG PROFILE

- A. When more than one borings are drilled for the project, boring log profile(s) along the project alignments(s) shall be included in the Geotechnical Report as shown on Figure 11.4.
- B. If the invert depths of utility line are known, then utility line shall be plotted on the boring log profile(s) as shown on Figure 11.4.

11.19 ENVIRONMENTAL CONCERNS

- A. The Geotechnical Consultant shall look for obvious signs of visual staining of the soil samples, note any odors (specifically of hydrocarbon nature) during drilling, and summarize this information in the report.

11.20 GEOTECHNICAL INVESTIGATION REPORT – GENERAL REQUIREMENTS

- A. The Geotechnical Investigation Report shall be an in-depth evaluation that entails a review of available pertinent literature, geologic fault information, field subsurface investigation, laboratory testing, engineering analysis of the data obtained, and recommendations concerning the proposed facilities.
- B. The content of the Geotechnical Investigation Report shall be project specific.
- C. The Geotechnical Consultant shall review any soil information (provided by the City's Project Manager) that may be available from the previous project design activities. The summary is to be included in the Subsurface Conditions section of the Geotechnical Investigation Report. The borings logs and the plan of borings shall be included in the appendix of the Geotechnical Investigation Report.
- D. Any illustration containing copyright information (e.g., aerial views from the Internet or Key Map for Plan of Borings, Vicinity Map, etc.) shall have proper reproduction permission and credits written on the illustration.

- E. All drawings (including drawings for the slope stability analyses) shall be at a scale available on a standard engineering scale.
- F. The pavement design shall be in accordance with the latest edition of the AASHTO Guide for Design of Pavement Structures.
- G. The Geotechnical Consultant shall perform a quality control review of the Geotechnical Investigation Report before its submittal. The Engineer of Record shall provide a separate review of the Geotechnical Investigation Report prior to its submittal.
- H. For the City of Houston projects, the Geotechnical Consultant shall submit a Draft Geotechnical Investigation Report (hard copy) to the City of Houston for review prior to submitting the Final Geotechnical Investigation Report. The title of the report shall identify if the report is a draft or final report.
- I. The Final Geotechnical Investigation Report shall be signed and sealed by a Licensed Engineer.

11.21 GEOTECHNICAL REPORT – RECOMMENDATIONS

The minimum geotechnical recommendations shall address the following:

- A. Open-Cut Installation: Bedding, backfill, excavation wall and bottom stability, thrust restraint, dewatering, and pipe design parameters.
- B. Auger Installation: Soil design parameters, ground stability, auger pit excavation stability, and dewatering.
- C. Tunnels and Shafts: External pressures on primary and permanent liners, wall and bottom stability, and dewatering.
- D. Open Channel: Slope angle or slope ratio, setback distance for structures or appurtenances included in the project, and erosion protection.
- E. Detention Pond: Slope angle or slope ratio, setback distance for structures or appurtenances included in the project, and erosion protection.
- F. Paving:
 - 1. The requirements in Chapter 10 “Street Paving Design Requirements” of the City of Houston Infrastructure Design Manual shall be followed.
 - 2. For rigid paving: At a minimum, the pavement thickness and minimum subgrade treatment shall be included. All the selected design parameters used in obtaining the pavement thickness shall be provided in the report.

3. For flexible paving: At a minimum, the design Structural Number (SN), recommended pavement section and its SN, and subgrade treatment shall be included. All the selected design parameters used in obtaining the pavement thickness shall be provided in the report.
4. For overlay projects, recommendations for rehabilitation shall be provided.

11.22 GEOTECHINCAL REPORT – TABLE OF CONTENTS

- A. The Geotechnical Investigation shall be presented in report including the text sections, tables, illustrations, and appendices as shown below:

Transmittal Letter – The transmittal letter in accordance with the TBPE rules.

Executive Summary – Summarize the work performed for the project including findings and recommendations.

Table of Contents (with page numbers)

1. Introduction
 - a. General
 - b. Authorization
 - c. Location and Description of the Project
 - d. Purpose
 - e. Scope
2. Field Investigation
 - a. General
 - b. Geotechnical Borings
 - c. Piezometer Installation
3. Laboratory Testing
4. Subsurface Conditions
 - a. Geology
 - b. General Fault Information
 - c. Soils Stratigraphy
 - d. Soils Stratigraphy from the Previous Project Design Activities (if applicable)
 - e. Water Levels
5. Engineering Analyses and Recommendations
6. Construction Considerations

7. Limitations
 8. Tables
 - a. Summary of Boring Information (such as depth, survey information, etc)
 - b. Geotechnical Design Parameters
 - c. Summary of Test Results
 9. Illustrations (varies based on the project requirements)
 - a. Vicinity Map
 - b. Fault Map
 - c. Plan of Borings
 - d. Boring Log Profile (showing utility lines)
 - e. Earth Pressure Diagrams
 - f. Thrust Force
 - g. Liner Load
 - h. Vertical Stress on the Pipe
 - i. Stability of Bottom for Braced Cut
 - j. Uplift Resistance
 - k. Pile/Shaft Capacity Curves
 - l. Any other relevant illustration
 10. Appendices (several of the following may be combined in one appendix)
 - a. Boring Logs in gINT format
 - b. Piezometer Installation Report (Figure 11.1 and reports submitted to the TDLR)
 - c. Piezometer Plugging Report (the report submitted to the TDLR)
 - d. Grain Size Distribution Curves (if applicable)
 - e. CBR, CU, Pinhole, or any other test results (if applicable)
 - f. Slope Stability Analyses Information (if applicable)
 - g. Fault Study Report (if applicable)
 - h. Information from the Previous Project Design Activities (if applicable)
 - i. Any other relevant information
- B. When required, a separate Trench Safety Report shall be provided for the City of Houston projects. The Trench Safety Report shall satisfy statutory requirements for contracting for trench safety construction.
- C. The Geotechnical Consultant shall provide an electronic version (in pdf format) of the entire Final Geotechnical Investigation Report (one file).
- D. The Geotechnical Consultant shall also provide electronic files of the final boring logs. The files must be compatible with input files used by “gINT” LogWriter software.

(Continued on next page)

**FIGURE 11.1
 PIEZOMETER INSTALLATION REPORT FORMAT**

PIEZOMETER INSTALLATION REPORT

PROJECT NAME	PIEZOMETER NUMBER: B-??P	
GEOTECHNICAL CONSULTANT	DESIGN CONSULTANT	CITY OF HOUSTON

COMPLETION DATE: _____ DRY AUGERED _____ TO _____ FT WASH BORED _____ TO _____ FT DRILLING FLUID: _____	DEPTH (FT) 0 _____ _____ _____ _____ _____ _____ _____	APPROX. ELEV. (FT) _____ _____ _____ _____ _____ _____ _____	RISER PIPE SHOULD BE SHOWN INSTEAD OF MANHOLE COVER, WHERE APPLICABLE <p style="text-align: right;"> MAN HOLE COVER TYPE OF BACKFILL: CEMENT-BENTONITE RISER PIPE TYPE: PVC CASING, I.D. 2" TYPE OF COUPLING: THREADED TYPE OF SEAL: BENTONITE TYPE OF FILTER: FILTER SAND SCREEN TYPE: SLOT, I.D. 2", SLOT SIZE 0.01" TYPE OF BOTTOM CAP: THREADED PVC </p> <p style="text-align: center;">(NOT TO SCALE)</p>
DEVELOPMENT DATE: _____ METHOD OF DEVELOPMENT: _____ BAILING			
WATER LEVEL READINGS: DATE DEPTH (TOG) APPROX. ELEVATION (FT)			
REMARKS:			

NOTES: 1. DIMENSIONS NOMINAL UNLESS OTHERWISE NOTED 2. TOG = TOP OF GROUND	DRILLED BY:	STARTED:	APPROX. STATION:
	LOGGED BY:	COMPLETED:	GROUND LEVEL (MSL):
	CHECKED BY:	APPROVED BY:	COORDINATES:

Company Name (option)

FIGURE

**FIGURE 11.3
 BORING LOG FORMAT**

LOG OF BORING NO. B-																			
PROJECT :					PROJECT NO. :														
LOCATION : N xx,xxx.x, E xx,xxx.x See Plan of Borings (Figure no)					COMPLETION DEPTH : FT.														
SURFACE ELEVATION : FT.					DATE : MM-DD-YY														
ELEVATION, FEET	DEPTH, FEET	SYMBOL	SAMPLES	SAMPLER : Shelby Tube/Split Spoon		STANDARD PENETRATION TEST, BLOWS PER FOOT	PERCENT PASSING NO. 200 SIEVE	DRY UNIT WEIGHT, PCF	NATURAL MOISTURE CONTENT, %	LIQUID LIMIT, %	PLASTIC LIMIT, %	PLASTICITY INDEX, %	UNDRAINED SHEAR STRENGTH, TSF						
				DRY AUGER : TO FT.	WET ROTARY : TO FT.								○ HAND PENETROMETER ● UNCONFINED COMPRESSION ■ UNCONSOLIDATED-UNDRAINED TRIAXIAL COMPRESSION △ TORVANE						
DESCRIPTION OF MATERIAL																			
0																			
5																			
10																			
15																			
20																			
25																			
30																			
35																			

DEPTH TO WATER IN BORING :
 ♣ : FREE WATER 1st ENCOUNTERED AT 10.0 FT. DURING DRILLING; AFTER 15.0 MIN. AT 8.0 FT.
 ♠ : WATER DEPTH AT 7.5 FT., HOLE OPEN TO 35.0 FT. ON mm-dd-yy.

Drilled By: _____ Logged By: _____

Company Name

FIGURE

FIGURE 11.4
BORING LOG PROFILE FORMAT

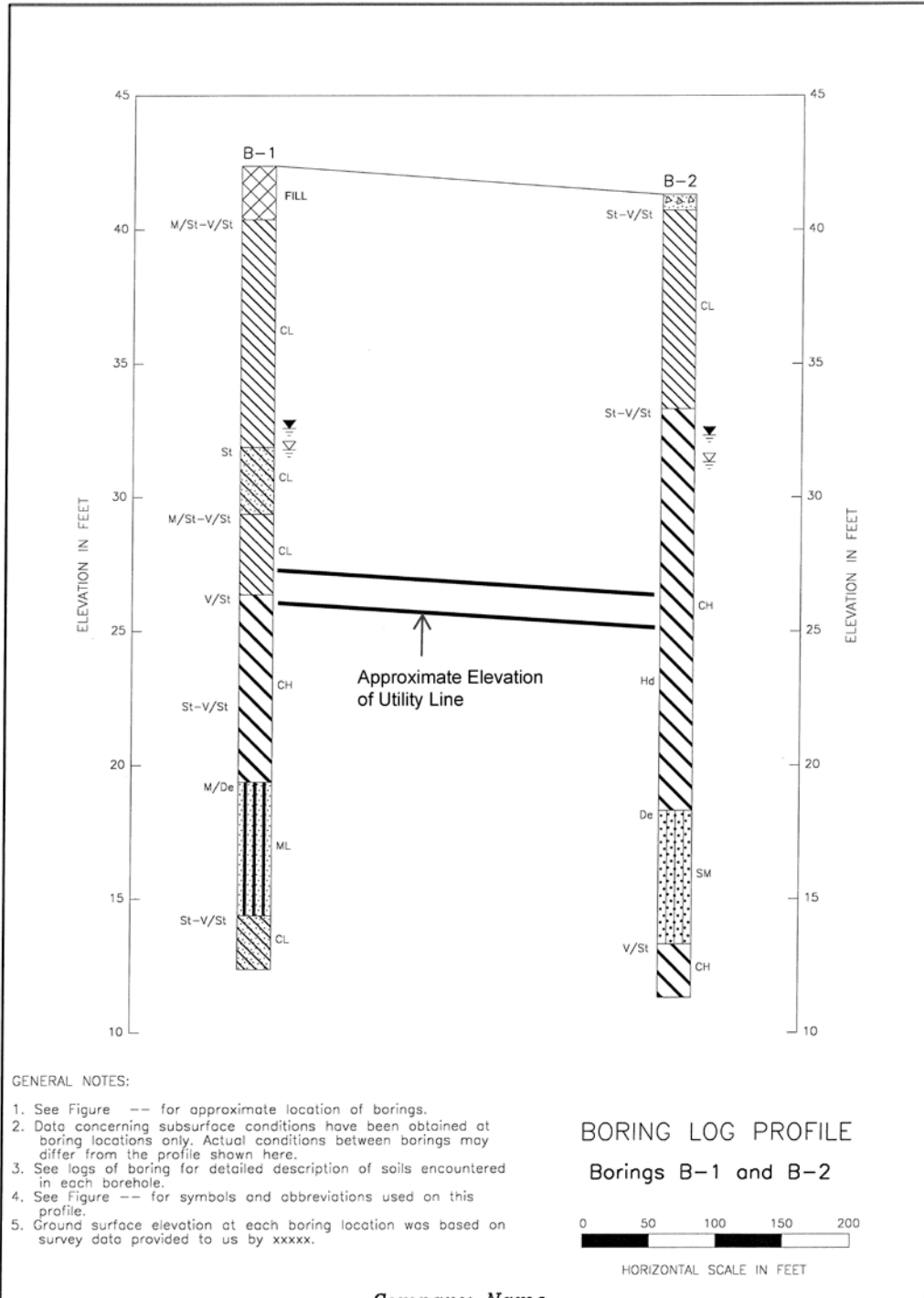

FIGURE

Chapter 11 (Continued)

11.23 INTRODUCTION TO PHASE I ENVIRONMENTAL REQUIREMENTS

This chapter categorizes various types of projects that require an ESA I and sets a minimum scope of work for:

- A. Property to be acquired by the City of Houston and property involved in divestitures and inter-departmental transfers; and
- B. The City of Houston construction projects.

11.24 PROPERTY TO BE ACQUIRED BY THE CITY OF HOUSTON AND PROPERTY INVOLVED IN DIVESTITURES AND INTER-DEPARTMENTAL TRANSFERS

The ESA I conducted on property to be acquired by the City of Houston shall conform to the latest ASTM Standard Practice E1527 with the following stipulations:

- A. The sources of historical data reviewed for a site shall include, at a minimum, historical aerial photographs, fire insurance maps (where available), local city street directories (where available), and United States Geological Survey (USGS) maps. The chain-of-title search is not required as an historical search. Applicable copies of these sources shall be presented in the report. Since City Directories are copyright protected, copies of these should not be presented in the report. One aerial photograph for every five to ten years interval from approximately 1950 to the present shall be obtained of an appropriate scale (1" = 500', or shall not exceed 1" = 700') to clearly indicate site details. Sites inside the IH-610 Loop shall have property usage identified from the present, back a minimum of 100 years (where available), or to the property's obvious first development, whichever is earlier.
- B. If regulatory records indicate that Leaking Petroleum Storage Tank (LPST) facilities are located within approximately 500 feet of the site, the latest comprehensive assessment or monitoring report maintained on the facility by the TCEQ (Houston District Office) shall be reviewed and summarized in the ESA I report. Any review of records shall be conducted during the ESA I.
- C. If regulatory records indicate that a federal/state superfund facility is located within approximately ¼ mile of the site, the files maintained on that facility by the TCEQ shall be reviewed and summarized in the ESA I report.
- D. The TCEQ's Voluntary Cleanup Program (VCP) database shall be searched for facilities that are located within approximately 500 feet of the site.
- E. If the project includes demolition/renovation of buildings/structures, the ESA I report shall include recommendation for asbestos survey.

- F. If the project includes renovation of buildings/structures constructed before 1978, the ESA I report shall include recommendation for lead based paint survey.
- G. If the site includes undeveloped property, available wetlands maps shall be obtained and reviewed, the presence of hydric soil types shall be reviewed using published information, and the presence of standing or flowing water shall be investigated during the site inspection. The environmental professional shall make a statement in the report concerning the potential for the presence of wetlands on the site and whether or not full wetlands determination delineation is needed.
- H. If the site is in an area of known oil and gas production operations, a record search for oil and gas exploration and production wells on or adjacent to the site shall be included in the ESA I.
- I. Flood Insurance Rate Maps (FIRM) available from the Federal Emergency Management Agency (FEMA) shall be reviewed to identify areas of the subject site located within flood plains.
- J. A minimum of five interviews (where applicable) shall be conducted in accordance with the latest ASTM E1527 Standard Practice.
- K. The environmental professional who conducted the ESA I shall make recommendations for an ESA II, as appropriate, which shall be thorough enough to support an ESA II.

11.25 THE CITY OF HOUSTON CONSTRUCTION PROJECTS

The ESA I conducted on rights-of-way which will be involved in City construction projects shall conform to the latest ASTM Standard Practice E1527 with the following stipulations:

- A. The approximate minimum search distance for Standard Environmental Record Sources, except for Federal National Priorities List (NPL), Federal Resource Conservation and Recovery Act – Treatment, Storage, and/or Disposal (RCRA TSD) Facilities, and Texas Hazardous Waste Sites (HWS)/Texas State Superfund Sites, may be reduced, pursuant to ASTM E1527, to a radius of 500 feet unless there is a justifiable reason to maintain a larger radius. The minimum search distance for Federal NPL, Federal RCRA TSD and Texas HWS facilities shall be maintained at the ASTM specified distance of 1.0 mile.
- B. The sources of historical data reviewed for a site shall include, at a minimum, historical aerial photographs, fire insurance maps (where available), local city street directories (where available), and United States Geological Survey (USGS) maps. The chain-of-title search is not required as an historical search. Applicable copies of these sources shall be presented in the report. Since City Directories are copyright protected, copies of these should not be presented in the report. One aerial photograph for every five to ten years interval from approximately 1950 to the present shall be obtained of an appropriate scale (1" = 500', or shall not exceed 1" = 700') to clearly indicate site details.

- C. If the regulatory records indicate that LPST facilities are located within 500 feet of the site, the latest comprehensive assessment or monitoring report maintained on the facility by the TCEQ (Houston District Office) shall be reviewed and summarized in the ESA I report. Any review of records shall be conducted during the ESA I.
- D. If regulatory records indicate that a federal/state superfund facility is located within approximately ¼ mile of the site, the files maintained on that facility by the TCEQ (Houston District Office) shall be reviewed and summarized in the ESA I report.
- E. The TCEQ's VCP database shall be searched for facilities located within approximately 500 feet of the site.
- F. If the project includes demolition/renovation of buildings/structures, the ESA I report shall include recommendation for asbestos survey.
- G. If the project includes renovation of buildings/structures constructed before 1978, the ESA I report shall include recommendation for lead based paint survey.
- H. If the site includes undeveloped property, available wetlands maps shall be obtained and reviewed. The environmental professional shall make a statement in the report concerning the potential for the presence of wetlands on the site and whether a full wetlands determination or delineation is recommended.
- I. If the site is in an area of known oil and gas production operations, a record search for oil and gas exploration and production wells on or adjacent to the site shall be included and discussed in the ESA I.
- J. The FIRM available from the FEMA shall be reviewed and discussed to identify areas of the subject site located within flood plains.
- K. A minimum of five interviews, where applicable, shall be conducted in accordance with the latest ASTM E1527 Standard Practice.
- L. The environmental professional who conducted the ESA I shall make recommendations for an ESA II, as appropriate, which shall be thorough enough to support an ESA II.
- M. The Environmental Consultant shall submit a Draft Environmental Site Assessment Report (hard copy) to the City of Houston for review prior to submitting the Final Environmental Site Assessment Report. The title of the report shall identify if the report is a draft or final report.
- N. The Environmental Consultant shall provide an electronic version (in pdf format) of the entire Final Environmental Site Assessment Report (one file).

(Continued on next page)

Chapter 11 (Continued)

11.26 INTRODUCTION TO PHASE II ENVIRONMENTAL REQUIREMENTS

The primary objective for performing an ESA II is to evaluate the recognized environmental conditions (REC) identified in the ESA I for the purpose of providing information regarding the nature and extent of contamination to assist in engineering design process. The ESA II shall conform to the latest ASTM Standard Practice E1903 with the following stipulations.

11.27 FIELD INVESTIGATION NOTIFICATIONS

The Environmental Consultant or Engineer of Record shall inform the City's Project Manager (via email or fax) about the start date of drilling approximately 48 hours prior to beginning drilling.

11.28 PROCEDURES

The following are the minimum requirements for an ESA II to be conducted for the City of Houston projects, land acquisitions, and inter-departmental transfers.

A. Field Activities

The location and depth of borings shall be based on the proposed construction activities, and any previous environmental reports pertaining to the project location, if reasonably available.

1. *Frequency of samples* –
 - a. For linear project, the boring shall be advanced incrementally (every one foot) to permit continuous sampling. Three (3) or more borings (approximately 100 feet apart for a rough delineation) shall be drilled along the proposed excavation at each REC location.
 - b. For non-linear project, the frequency and spacing of the borings should be determined by the environmental consultant in consultation with the City's project manager.
2. *Termination of boring* - Borings shall be advanced to a maximum depth of five (5) feet below the planned excavation. Borings may be advanced to greater depths if warranted by site-specific circumstances. If borings are terminated due to field conditions (e.g., obstructions), borings should be relocated at the discretion of the environmental professional.
3. *Cross-contamination* - To prevent cross-contamination, sampling and boring equipment shall be decontaminated prior to drilling each soil boring and collecting samples. Environmental consultant shall follow applicable federal, state, and local regulations to prevent cross-contamination between soil samples.

4. *Sampling procedure:*
 - a. Soil
 - i. Obtain a minimum of one soil sample from each boring for laboratory analysis. Additional soil samples may be collected as deemed necessary by the environmental professional.
 - ii. Perform field screening of all soil samples obtained from borings.
 - iii. The sample for laboratory analysis shall be collected from the zone exhibiting the highest PID/OVA reading. If the PID/OVA readings are non-detected, the sample shall be collected from the soil-groundwater interface. If no saturated zone exists, then the sample shall be collected from the bottom of the boring.
 - iv. Place all samples in clean pre-labeled containers composed of materials with the appropriate preservatives as required by the respective analytical method. To prevent volatilization, place samples on ice in an insulated cooler prior to and during transportation to the analytical laboratory for analysis.
 - b. Groundwater

If groundwater is encountered during drilling, one (1) groundwater sample shall be collected from each REC location. The groundwater sample shall be collected from a temporary installed monitoring well (piezometer).
 - c. Each boring log shall include the following:
 - i. Soil classification according to ASTM D2488.
 - ii. Detection of hydrocarbon or other odors.
 - iii. Visible hydrocarbon or other contamination (if present, including degree, location, and extent of staining).
 - iv. PID/OVA readings.
 - v. Other field screening as required by the type of contaminations.
 - vi. The depth at which groundwater was first encountered.
 - vii. Location of boring.
 - viii. Boring identification.
 - ix. City project number.
5. *Site Clean up and Restoration* - The environmental professional is responsible for the site clean up upon completion of drilling, commensurate with site conditions.

a. Generation of Waste

- i. Wastes may be generated during the assessment implemented as part of the ESA II (for example, drill cuttings and purged groundwater, etc.). The wastes generated during the assessment should be collected and stored in tightly fitted container(s).
- ii. Wastes should be categorized according to the regulatory requirements and disposed at an approved facility within a 60-day time frame. All completed waste manifests are to be returned to the City's project manager.
- iii. Techniques that minimize the generation of waste shall be utilized to the extent feasible, consistent with the information and data quality objectives of the planned assessment and applicable regulatory requirements.

b. Backfill of Borings

Completed borings shall be backfilled with cement-bentonite or non-shrink grout. Boreholes or other cored penetrations of pavements shall be restored with the same or equivalent materials as the existing pavement.

B. Laboratory Analysis

1. Environmental Consultant shall perform analytical testing in accordance with applicable United States Environmental Protection Agency (USEPA) and the TCEQ procedures.
2. Laboratory Documentation
 - a. Chain of Custody

A completed chain of custody record shall accompany each shipment of samples to the analytical laboratory, and shall be included in the report.

- b. Laboratory Results

Laboratory results for samples shall include the following:

- i. Date of collection.
- ii. Date of extraction, analysis, and report.
- iii. Extraction and analytical methods used.
- iv. Method detection limits.
- v. Standard utilized in the analysis.
- vi. Sample identification and depth.
- vii. Laboratory QA/QC report.

C. Report

1. Site Characterization

- a. The soil characteristics of significance to the design and construction work shall be described with particular emphasis on the occurrence of transmissive soils at or below the elevation in which contamination was detected, or which have potential for providing pathways for contaminant migration. Geologic characteristics, which affect the migration potential of a contaminant, shall be addressed.
- b. Potential sources of contamination shall be clearly described in the report. Areas of contamination within or adjacent to the project site which were confirmed, and their spatial relationship to the planned construction activity, shall also be clearly identified.

2. Type of Contamination

- a. The report shall address the basis for determining which contaminants were potentially present and the methods that were used to verify their presence or absence. Where specific contaminants are present, the report is to describe the concentrations and indicate whether or not they are above relevant action levels.

3. Impact of Planned Construction

- a. The report shall describe, based on the available information, the estimated vertical extent and lineal extent (station-to-station) of the PPCA at the REC location. The determination of probable extent should be based on reasonable interpretation of both analytical and geological data. The report shall clearly address the following:
 - i. Comparison of contaminant concentration to regulatory criteria.
 - ii. Potential for contaminated runoff entering the work area.
- b. The report shall address the potential impact of the contamination on the planned construction including the potential for contaminant impact on construction dewatering. Specifically, the report shall address the potential for migration of contamination from the investigated sources and plumes into the construction area, and due to groundwater withdrawal.
- c. A quality control review of the Environmental Report shall be performed by the Engineer of Record, where applicable, before its submittal to the City of Houston.

4. Recommendations

The report shall provide recommendations for construction phase monitoring which should take into account:

- a. Vertical extent and Lineal extend (station-to-station) of PPCA and action plan.
- b. Worker protection and general health and safety.
- c. Potential contaminated media screening, testing, handling, and disposal consistent with Federal, State, and City Regulations and Specifications.

5. Exhibits

- a. Site plan identifying the location of the REC's and boring locations.
- b. Boring logs for each boring.
- c. Analytical results including tables summarizing analytical results.
- d. Photographs of drilling activities.

6. The Environmental Consultant shall submit a Draft Environmental Site Assessment Report (hard copy) to the City of Houston for review prior to submitting the Final Environmental Site Assessment Report. The title of the report shall identify if the report is a draft or final report.

7. The Environmental Consultant shall provide an electronic version (in pdf format) of the entire Final Environmental Site Assessment Report (one file).

(Continued on next page)

Sample Table of Contents

EXECUTIVE SUMMARY

- 1.0 INTRODUCTION
 - 1.1 Objectives
 - 1.2 Scope of Work
- 2.0 SUBSURFACE INVESTIGATION
 - 2.1 Field Investigation Methodologies
 - 2.2 Selected Sites
- 3.0 LABORATORY ANALYTICAL PROGRAM
- 4.0 DATA EVALUATION
- 5.0 CONCLUSIONS
 - 5.1 Summary of the Investigation Results
 - 5.2 Impact on Planned Construction

TABLES

- 1 Soil Sample Analytical Results
- 2 Groundwater Sample Analytical Results

FIGURE(S)

- Site Plan(s)
 - Boring / well locations
 - Underground storage tank (UST) system or other suspected sources
 - Facility details

APPENDIX A

Boring Logs

APPENDIX B

Laboratory Analytical Reports
Chain of Custody

END OF CHAPTER

City of Houston

Design Manual

Chapter 12

STREET CUT REQUIREMENTS

Chapter 12

STREET CUT REQUIREMENTS

12.01 CHAPTER INCLUDES

- A. Criteria for street pavement cuts, excavation, backfill, and pavement restoration in Public Ways.
- B. This chapter applies to excavation under paved surfaces in Public Ways which have been improved for street, sidewalk, surface drainage, or related public transportation infrastructure.

12.02 References

- A. Refer to the list of references in Chapter 1, General Requirements.
- B. City of Houston Procedural Guidelines for Planning and Permitting of Excavations in Public Ways, latest revision.

12.03 DEFINITIONS

- A. Excavation – An activity that disturbs, alters, or penetrates any portion of the public way that has been improved for street, driveway, sidewalk, surface drainage, or related public transportation infrastructure purposes. The term includes but is not limited to cutting, tunneling, jacking and boring, backfilling, restoring, and repairing the public way. The term does not include a transportation improvement or maintenance of publicly owned utility systems, such as water and wastewater lines and facilities.
- B. Backfill – Excavation fill material that meets city specified quality requirements or the placement thereof.
- C. Facility – Any structure device or other thing whatsoever that may be installed or maintained in, or, within, under, over or above a public way by an excavation.
- D. Five – Year CIP – Street improvement projects included in a Capital Improvement Program by the City of Houston, Harris County, METRO, TxDOT, or other organization for construction.
- E. Hole – Excavation in the Public Way with the excavation having a length less than the width of the pavement.

- A. Patch – Method of pavement replacement that is temporary in nature. A patch consists of: (1) the compaction of the subbase and aggregate base, and (2) the replacement, in kind, of the existing pavement for a minimum of two feet beyond the edges of the excavation in all directions. A patch is full restoration only when the pavement is included in the City of Houston’s Five Year Capital Improvement Plan.
- B. Public Way – Any public street right-of-way located in the city, including the entire area between the boundary lines of every way (including but not limited to roads, streets, alleys, highways, boulevards, bridges tunnels, or similar thoroughfares), whether acquired by purchase, grant, or dedication and acceptance by the city or by the public that has been opened to use of the public for purpose of vehicular travel.
- C. Restoration – The process by which an excavated public way and surrounding area, including pavement and foundation, is returned to the same condition that existed before excavation.
- D. Trench – An excavation in the pavement with the excavation having length equal to or greater than the width of the pavement.

12.04 DESIGN REQUIREMENTS

- 1. Design project so that restoration returns public way to the same condition that existed prior excavation. Base minimum limits and methods required for restoration on City Standard Details.
- B. Comply with requirements of 6.08A, Open Cut Construction in Street Pavement, for all open-cut construction including excavation for auger or directional drilling insertion pits.
 - 1. Saw cut existing pavements along lines parallel to and perpendicular to traveled way center lines unless otherwise approved by the City Engineer.
 - 2. For concrete pavements, conform to requirements of Paragraphs 10.04, K., 5., 10., and 11.
- C. Prepare plan view drawings for all excavations that identify and locate existing underground facilities. The drawings, or verification statements, shall confirm that the underground facilities have been identified, located, and marked by the following organizations:
 - 1. Texas Underground Facility Notification Corporation,
 - 2. City of Houston Public Utilities (water and sewer), and
 - 3. City of Houston Traffic Signal Section.

- D. The City may require plan and profile drawings for complex projects or when the constructing agency has demonstrated previous non-compliance with underground facility location procedures.
- E. Plan view drawings shall show, at a minimum, the following information for the project area:
 - 1. Topographical features.
 - 2. Existing public and private utilities.
 - 3. Significant landscaping or other structures which might impact construction or construction related activities.
 - 4. Location and dimensions of proposed surface cuts.
 - 5. Location and depth of existing and proposed mains, cables, conduits, switches, and related equipment and facilities.
 - 6. Use baseline offsets from property lines, centerline of the public way, or curb lines; or a coordinate system acceptable to the City.
- F. Final drawings shall include a list City of Houston Standard Specifications and related standard details for excavation, bedding, backfilling, and pavement repair and resurfacing.

12.05 QUALITY ASSURANCE

- A. For projects which include conduits, duct banks or pipelines over 1", have final design drawings sealed, signed, and dated by the Professional Engineer responsible for development of the drawings.

END OF CHAPTER

City of Houston

Design Manual

Chapter 13

STORMWATER QUALITY DESIGN REQUIREMENTS

Chapter 13

STORM WATER QUALITY DESIGN REQUIREMENTS

13.01 CHAPTER INCLUDES

- A. Criteria for the design of storm water pollution prevention procedures and controls for construction activities.
- B. Criteria for the design of permanent storm water pollution prevention procedures and controls to minimize impacts for new development and decrease impacts for redevelopment on tracts of land of 5 acres or more.

13.02 REFERENCES

- A. Storm Water Quality Management Guidance Manual, 2001 edition, City of Houston.
- B. Storm Water Management Handbook for Construction Activities, 2001 edition, City of Houston.
- C. Select Minimum Design Criteria for Implementation of Best Management Practices for Water Runoff Treatment, 2001 edition, City of Houston.
- D. Article XII of Chapter 47 of the City of Houston Code of Ordinances.
- E. National Pollution Discharge Elimination System Permit Number TXS001201.

13.03 DEFINITIONS

- A. Dwelling Unit - A structure, or a portion of a structure, that has independent living including provisions for nontransient sleeping, cooking and sanitation.
- B. Impervious Surface - Any area that does not readily absorb water, including, but not limited to, building roofs, parking and driveway areas, sidewalks, compacted or rolled areas, and paved recreation areas.
- C. New Development - Development on a currently undeveloped parcel of land five acres or larger without regard to the amount of land that will actually be disturbed, except for development on an existing undeveloped and undivided parcel of five acres or more of one single-family dwelling unit and/or the types of non-commercial building(s) typically associated with a single-family dwelling unit, including, but not limited to, a garage, carport or barn. If the occupancy for any structure excluded under the foregoing exception at any

time changes to a commercial use, the owner of the property will at that time have to comply with all requirements of this program.

- D. Significant redevelopment - Changes of one acre or more to the impervious surface on a five acre or larger developed parcel.
- E. Applicant - The owner of the land on which the new development or significant redevelopment will occur, or his authorized agent.
- F. NPDES - National Pollutant Discharge Elimination System.
- G. SWQMP - Storm Water Quality Management Plan.
- H. Regulated Construction Activity - Construction activities, including clearing, grading, and excavation, that disturb either five acres or more, or less than five acres if the activities are part of a larger plan of development or sale.

13.04 DESIGN REQUIREMENTS

A. Construction Activity:

1. Storm Water Pollution Prevention Plans (SWPPPs) and Best Management Practices (BMPs) will be developed in accordance with the Storm Water Management Handbook for Construction Activities.
2. Construction plans will include a note requiring contractor to comply with construction permit including preparation of a SWPPP and to provide a copy of the Notice of Intent (NOI) and maintenance checklist to the City 5 work days prior to commencement of any construction activity to City Engineer or Building Official.

A. New Development and Significant Redevelopment:

1. All design must be consistent with the Storm Water Quality Guidance Manual (SWQGM) and the Minimum Design Criteria for Certain Storm Water Runoff Treatment Options (MDC), 2001 edition.
2. A letter of availability must be included with the Storm Water Quality Management Plan
3. Pollutants expected from the site must be identified. BMPs must be designed and selected to remove the pollutants identified.
4. At a minimum, the system must be designed to treat the first 1/2 inch of runoff, except as noted in the SWQGM or the MDC.

5. BMPs listed in the SWQGM but not in the MDC may be acceptable for implementation pending review of design calculations and site applicability. BMPs not listed in the SWQGM may be considered on a case by case basis. Acceptance of these BMPs will require not only review of design calculations and site applicability, but also review of case studies or other data provided by an uninterested third party indicating the effectiveness of the BMP. All calculations and literature must be provided as part of the plan submittal.
6. In addition to meeting the storm water quality requirements discussed in the Design Manual Chapter 13 and its referenced documents, the storm water system must meet the flood control requirements presented in Chapter 9 of the Design Manual.

C. Low Impact Development (LID):

1. Bioretention

a. Overview

Bioretention is a terrestrial-based (up-land as opposed to wetland), water quality and water quantity control practice using the chemical, biological and physical properties of plants, microbes and soils for removal of pollutants from storm water runoff. Some of the processes that may take place in a bioretention facility include: sedimentation, adsorption, filtration, volatilization, ion exchange, decomposition, phytoremediation, bioremediation, and storage capacity. Bioretention may also be designed to mimic predevelopment hydrology.

b. Design Criteria

- (1) Determine volume of bioretention area below maximum design water surface. Depth of ponding limited to a maximum of 6 inches.
- (2) Demonstrate that sufficient area contributes stormwater runoff to the bioretention area to fill the area to its maximum design water surface for the design storm under consideration.
- (3) Using in-situ or new soils, design the bioretention area to empty within 48 hours. This may be accomplished through infiltration, evapotranspiration, and/or the design of a subsurface drainage system.
- (4) Mitigating detention volume requirements can be reduced by the volume in the bioretention area below its maximum design water surface.
- (5) Runoff from commercial areas and parking lots require pretreatment; grass buffer strip or vegetated swales, prior to draining into bioretention area.
- (6) Infiltration rates less than 0.5 inches per hour will require a subsurface drainage system.
- (7) Geotechnical testing is required to confirm infiltration rates.

- c. Inspection and Maintenance Requirements
 - (1) Verify presence of vegetation considered in design computations (if any) quarterly.
 - (2) Verify the bioretention area has adequate volume quarterly by checking whether sedimentation has encroached on design volume. This can be done by comparing actual maximum depth against design maximum depth.
 - (3) Verify ability of bioretention area to drain within 48 hours twice yearly after rainfall event.
 - (4) Correct deficiencies related to items 1-3 above as needed.

2. Infiltration Trenches

a. Overview

Trenches or basins that temporarily detain a design water quality volume while allowing infiltration to occur over a prescribed period of time. Trenches are applicable for both water quality and water quantity control practices.

b. Design Criteria

- (1) In-situ subsoil shall have a minimum infiltration rate of 0.5 inches per hour. Geotechnical testing including one boring per 5000 square feet or two per project is required to confirm infiltration rate.
- (2) Subsurface drainage systems are required where the in-situ subsoil rate is less than 0.5 inches per hour or where the project is constructed on fill soils.
- (3) Avoid placement on slopes greater than 15% in fill areas.
- (4) Design of the trench area to empty with 48 hours.
- (5) Backfill using clean aggregate larger than 1.5" and smaller than 3" surrounded by engineered filter fabric.
- (6) Provide overflow structure or channel to accommodate larger runoff events.
- (7) Provide 4" PVC observation well into subgrade.
- (8) Runoff from commercial areas and parking lots require pretreatment; grass buffer strip or vegetated swabs, prior to draining into infiltration trench.
- (9) Locate bottom of facility at least 4 ft. above seasonal high water table elevation.
- (10) Locate at least 100 ft. from any water supply well.
- (11) Maximum contributing drainage area is 5 acres or less.
- (12) Mitigating detention volume can be reduced by the amount of infiltration into the subsoil and the volume of voids within the trench area.

c. Inspection and Maintenance Requirements

- (1) Inspect observation well for water level and drainage times. Conduct landscaping, mowing, and desilting of facility.

3. Porous Pavement

a. Overview

Porous Pavement consists of a permeable surface course that allows infiltration of stormwater runoff into a permeable layer of uniformly graded stone bed. The pavement surface may either be soft (grass) or hard (concrete, asphalt or advance gravel systems). The underlying permeable layer serves as a storage reservoir for runoff and/or infiltration. Porous Pavement is applicable for both water quality and water quantity control practices.

b. Design Criteria

- (1) In-situ subsoil shall have a minimum infiltration rate of 0.5 inches per hour. Geotechnical testing including one boring per 5000 square feet or two per project is required to confirm infiltration rate.
- (2) Subsurface drainage systems are required where the in-situ subsoil rate is less than 0.5 inches per hour or where the project is constructed on fill soils.
- (3) Shall be limited to lightly traveled surfaces such as parking pads in parking lots, trails and sidewalks. Porous pavement is not permitted for residential driveways (area of pavement likely to be coated or paved over because of a lack of awareness) and commercial areas designed for heavy traffic volume and/or vehicles.
- (4) Typical section of porous pavement and underlying permeable stone bed is shown on Figure 1 followed by a description of each layer of material.
- (5) Subsurface drainage systems are required to be drained in 48 hours.
- (6) If the volume of storage within the voids of the subsurface drainage system's stone bed meets the detention volume rate of 0.5 acre-feet per acre of development or 0.2 acre-feet per acre for tracts less than one acre, the area of the porous pavement is considered undeveloped. Otherwise, the total voids storage volume will be credited toward the required detention volume.
- (7) If the time of concentration (T_c) from a project site that includes porous pavement and subsurface drainage system, is equal to the undeveloped time of concentration, the development of the project site is considered undeveloped.
- (8) Soft porous pavement area shall be considered undeveloped.
- (9) The cross-section typically consists of four layers, as shown in Figure 1. The aggregate reservoir can sometimes be avoided or minimized if the sub-grade is sandy and there is adequate time to infiltrate the necessary runoff volume into the sandy soil without by-passing the

water quality volume. Descriptions of each of the layers is presented below:

Porous Concrete Layer – The porous concrete layer consists of an open-graded concrete mixture usually ranging from depths of 2 to 4 inches depending on required bearing strength and pavement design requirements. Porous concrete can be assumed to contain 18 percent voids (porosity = 0.18) for design purposes. Thus, for example, a 4 inch thick porous concrete layer would hold 0.72 inches of rainfall. The omission of the fine aggregate provides the porosity of the porous pavement. To provide a smooth riding surface and to enhance handling and placement a coarse aggregate of 3/8 inch maximum size is normally used.

Top Filter Layer – Consists of a 0.5 inch diameter crushed stone to a depth of 1 to 2 inches. This layer serves to stabilize the porous concrete layer. Can be combined with reservoir layer using suitable stone.

Reservoir Layer – The reservoir gravel base course consists of washed, bank-run gravel, 1.5 to 2.5 inches in diameter with a void space of about 40 %. The depth of this layer depends on the desired storage volume, which is a function of the soil infiltration rate and void spaces, but typically ranges from two to four feet. The layer must have a minimum depth of nine inches. The layer should be designed to drain completely in 48 hours. The layer should be designed to store at a minimum the water quality volume (WQv). Aggregate contaminated with soil should not be used. A porosity value (void space/total volume) of 0.32 should be used in calculations unless aggregate specific data exist.

Bottom Filter Layer – The surface of the subgrade should be a 6 inch layer of sand (ASTM C-33 concrete sand) or a 2 inch thick layer of 0.5 inch crushed stone, and be completely flat to promote infiltration across the entire surface. This layer serves to stabilize the reservoir layer, to protect the underlying soil from compaction, and act as the interface between the reservoir layer and the filter fabric covering the underlying soil.

Filter Fabric – It is very important to line the entire trench area, including the sides, with filter fabric prior to placement of the aggregate. The filter fabric serves a very important function by inhibiting soil from migrating into the reservoir layer and reducing storage capacity. Fabric should be MIRFI # 14 N or equivalent.

Underlying Soil – The underlying soil should have an infiltration capacity of at least 0.5 in/hr, but preferably greater than 0.50 in/hr. as initially determined from NRCS soil textural classification, and subsequently confirmed by field geotechnical tests. The minimum geotechnical testing is one test hole per 5000 square feet, with a minimum of two borings per facility (taken within the proposed limits of the facility). Infiltration trenches cannot be used in fill soils. Soils at the lower end of this range may not be suited for a full infiltration system. Test borings are recommended to determine the soil classification, seasonal high ground water table elevation, and impervious substrata, and an initial estimate of permeability. Often a double-ring infiltrometer test is done at subgrade elevation to determine the impermeable layer, and for safety, one-half the measured value is allowed for infiltration calculations.

* Figure 1 and cross section description obtained from the Georgia Stormwater Management Manual.

- c. Inspection and Maintenance Requirements
 - (1) Initial inspection of porous pavement shall be monthly for the first three months post construction.
 - (2) Semi-annual inspection to ensure pavement surface is free of sediment.
 - (3) Vacuum sweep hard porous pavement followed by high pressure hosing to keep voids free of sediment quarterly.
 - (4) Annually inspect pavement surface and subsurface drainage system (if any) for deterioration, spalling or malfunctioning.

4. Vegetative Swales

a. Overview

Vegetative Swales (dry or wet) are earthen, planted stormwater conveyances designed to filter a shallow depth of runoff (<4") for water quality improvement and to infiltrate stormwater. There are two types, dry or wet. Dry swales include an underdrain system. Wet swales do not. Swales are typically designed to convey runoff from larger storm events, however, treatment and infiltration is reduced during high flows. Infiltrative soils or an engineered porous subgrade is required for infiltration use. Vegetative Swales are applicable for both water quality and water quantity control practices.

b. Design Criteria for Dry Swale

- (1) Soil infiltration rate of 0.27 to 0.50 inches/hour.
- (2) Trapezoidal or parabolic cross section.
- (3) Bottom width should be 2 ft. wide minimum or 6 ft. wide max.
- (4) Longitudinal slope should range from 1% to 6%.

- (5) Flow depth should be less than 4 inches for water quality treatment.
- (6) Flow velocity should be less than 1 fps for water quality, less than 5 fps for 2-yr storm (non-erosive velocities for grass and soils).
- (7) Length should yield a 10 minute residence time.
- (8) Side slopes should be flatter than 3:1.
- (9) Maximum ponding time should be < 48 hours.
- (10) Use proper vegetation (grass or wetland plants) consistent with climate, ecoregion, soils, and hydric conditions.
- (11) Provide at least 3" of free-board during design storm.
- (12) Provide pretreatment of runoff into the swale.
- (13) Design details are shown in Figures 1 and 2, below.

c. Design Criteria for Wet Swale

- (1) Soil infiltration rate of 0.27 to 0.50 inches/hour.
- (2) Trapezoidal or parabolic cross section.
- (3) Bottom width should be 2 ft. wide minimum or 8 ft. wide max. to avoid gullyng or channel braiding.
- (4) Longitudinal slope should range from 1% to 6%.
- (5) Flow depth should be less than 4 inches for water quality treatment.
- (6) Flow velocity should be less than 1 fps for water quality, less than 5 fps for 2-yr storm (non-erosive velocities for grass and soils).
- (7) Length should yield a 10 minute residence time.
- (8) Slide slopes should be flatter than 3:1.
- (9) Maximum ponding time should be < 48 hours.
- (10) Use proper vegetation (grass or wetland plants) consistent with climate, ecoregion, soils, and hydric conditions.
- (11) Provide at least 3" of free-board during design storm.
- (12) Provide pretreatment of runoff into the swale.
- (13) Design details are shown in Figures 3 and 4, below.

d. Inspection and Maintenance Requirements

- (1) Mow dry swales as required during growing season to maintain grass heights in the 4 to 6 inch range. Wet swales, employing wetland vegetation or other low maintenance ground cover do not require frequent mowing. Remove sediment when 25% of the original water quality volume has been exceeded.

5. Green Roof

a. Overview

A green roof, in simplest terms, is a vegetated roof. The vegetation varies, but must be suitable to the local climate and be drought tolerant, unless a method of irrigation is also installed. Installation generally consists of a waterproof membrane installed over a suitably constructed roof deck. For in-situ

installations, an under-drain drainage system is installed over the membrane. A lightweight engineered soil is installed on top of the under-drain, as fill dirt or topsoil is typically too heavy to use in rooftop applications. The engineered soil is then planted with select vegetation. If a modular system is selected, the drainage system may already be incorporated into the design, along with the soil and vegetation, depending on the manufacturer. The substrate material and depth are also factors that influence the efficiency of the green roof to store and/ or treat stormwater. Roofs consisting of relatively thin soil layers, called extensive roofs, are not as heavy as the intensive roofs, which are covered with thicker soil layers.

b. Design Criteria

- (1) Vegetation suitable to the climate and preferably a species that is drought tolerant, unless a method of irrigation is provided, should be installed. The effect of wind on the vegetation should also be considered when selecting the roof foliage, as wind velocities are typically higher at rooftop elevations.
- (2) The amount of credit given for the rainfall amount stored shall be as prescribed by the manufacturer for a modular system.
- (3) The amount of credit given for the rainfall amount stored for non-modular systems shall be calculated for the engineered soil. The rate shall be derived by in-situ porosity testing. The porosity test shall be performed four times with the first time results being discarded and the three remaining results averaged. The test shall require the first sample remain wet a minimum of 1 hour. The subsequent porosity tests shall be performed the same day. In no case should the storage volume be credited more than 33% of total volume, as that is the assumed volume of clean graded washed gravel.
- (4) The roof membrane must be sufficiently designed and installed to pond a minimum of 1-inch of water at the most shallow point on the roof for 24 hours without leaks. This should be tested in the same manner as shower pans are tested under the building code. Additionally, special consideration should be given for the plant root structure and prevention of soil migration during membrane selection. A root barrier may also be required to protect the waterproof membrane integrity.
- (5) The under-drain drainage system should be designed for the selected plant's tolerance for drought and varying soil moisture contents by maintaining the proper balance of moisture and aerobic conditions within the soil media for optimum vegetation sustainability. Design provisions should address higher volume rainfall events to keep excessive amounts of water from ponding on top of the soil, to prevent erosion, and to prevent soil media saturation for extended periods. Structural calculations shall be submitted that demonstrate the structure's ability to sustain the additional loading of the green roof

appurtenances plus the maximum water weight that could be stored.

c. Inspection and Maintenance Requirements

- (1) A maintenance plan for the green roof system should be developed in accordance with the membrane manufacturer's instructions and plant species selected. At a minimum, maintenance inspections should be performed at least four times per year. The maintenance plan should include provisions for vegetation maintenance and replacement as needed to maintain a minimum 80% coverage/survival rate in order to sustain storm water quality and/or detention credits. Irrigation may be required initially in order to establish the roof vegetation and to supply water under severe drought conditions. Any requirements for initial or intermittent use of fertilizer and pesticides for disease or insect control should be identified in the plan. Plant species should be carefully selected to minimize intermittent fertilizer and pesticide applications.
- (2) Each green roof installation shall be inspected by the agency responsible for issuing the storm water quality or detention credits to check compliance with the approved drawings before final acceptance is issued and the proper credits are approved. At a minimum, the following items should be checked during the inspection:
 - (a) Results from porosity testing (for non-modular installations).
 - (b) Certification from a registered Professional Engineer or registered Architect that the green roof, including membrane, drain system and engineered soil system, was installed per the approved (permitted) drawings and operates as designed.
 - (c) Drawings of the green roof installation.
- (3) Once the green roof is installed and established, additional inspections will be required in order to properly maintain the vegetation, drainage system and roof membrane. Routine inspections should be conducted and associated maintenance activities performed on the following:
 - (a) Joints at adjoining walls, roof penetrations for vents, electrical and air conditioning conduits should be inspected regularly for leaks. The ceilings located directly below the green roof installation should also be visually inspected for signs of water staining or leaking.
 - (b) Designated drainage paths and drainage system components should be inspected to ensure proper surface drainage is maintained and that the soil layer is drained to prevent excessively saturated soils. Vegetation selected to tolerate drought conditions may rot or die if the soil is allowed to become saturated for extended periods.
 - (c) Vegetation should be visually inspected to identify weeds, accumulated trash or debris, dead or dying vegetation, disease or other infestation problems requiring maintenance attention. Weeds and dead vegetation should be removed on a regular

basis, especially right after the roof is planted. If a certain plant or grass species continues to die, that plant or grass should be removed and replaced with a more tolerant species. Certified professionals should only be used to apply chemical applications for the control of disease or insects at trouble spot locations.

- (d) Trimming and pruning should be done in accordance with horticulture practices to keep vegetation aesthetically groomed.

6. Hard Roof

a. Overview

Horizontal roof surfaces can be used to attenuate peak runoff associated with rainfall and effectively detain flow resulting from smaller rain events.

The detention volume can be controlled in several ways, but typically a simple drain ring is placed around the roof drains. As stormwater begins to pond on the roof, flow into the roof drains is controlled by orifices or slits in the drain ring. Extreme flows can be designed to overflow the ring and drain directly to the roof drains or be directed to openings in the parapet walls to prevent structural and flood damage to the roof. The roof deck must be designed to withstand the live load and be properly waterproofed.

b. Design Criteria

- (1) The structural capability of the roof system must be considered when designing a temporary rooftop storage system. For example, a three-inch water depth is equivalent to a load of 15.6 lbs/sq.ft., which is less than most current building code requirements for live loads.
- (2) Consideration must be given to the placement of electrical devices on the roof, such as air conditioning or ventilation systems and lights, and proper measures should be taken to protect the electrical devices from the collected water.
- (3) Overflow mechanisms shall be provided so that there is no danger of overloading the roof storage system during major storms. Additionally, roof slopes should be designed to drain positively toward the roof drains to help minimize localized roof ponding or 'bird bath' formation after the detained water volume is released.
- (4) It is recommended that Chapter 16 of the International Building Code, 2003 Edition be used for additional structural criteria along with ASCE Standard Reference Number 7, Minimum Design Loads for Buildings and Other Structures.
- (5) The amount of credit given for detention volume for rooftop storage should take into account that many flat roofs already pond significant amounts of water; although not by design. Therefore, when measuring credit given for hard roof detention volume, it is recommended that

only credit be given for the total rooftop storage volume less the rooftop storage volume associated with the first inch of rain. Typically, rooftop storage volumes are only effective during the smaller, more frequent rainfall events as the larger, less frequent storms typically exceed the rooftop storage capacity.

c. Inspection and Maintenance Requirements

(1) Each hard roof installation shall be inspected by the agency responsible for issuing the detention credits to check compliance with the approved drawings before final acceptance is issued and the proper credits are approved. At a minimum, the following items should be checked during the inspection:

- (a) Roof penetrations for ventilation, electrical or plumbing connections to verify proper sealing against leaks.
- (b) The overflow system that drains excessive rainfall off of the hard roof once the maximum storage volume is captured.
- (c) Certification from a registered Professional Engineer or registered Architect that the hard roof, drain system and appurtenances have been installed and operate as designed.
- (d) Drawings of the hard roof installation.

2. Once the hard roof is installed, additional inspections will be required in order to properly maintain the drainage system and roof membrane. Routine inspections should be conducted and associated maintenance activities performed on the following:

- (a) Designated drainage paths and drainage system components should be inspected to ensure proper surface drainage is maintained and that the roof is draining properly after the collected stormwater volume is released from a rainfall event.
- (b) Routine inspections to collect and remove any trash or debris from the roof should be conducted to prevent clogging of the roof drains and overflow drainage system.
- (c) Visible cracks in the roof surface should be identified and repaired in accordance with the roof manufacturer's recommendations in order to maintain roof integrity.

7. Rain Barrels

a. Overview

A cistern ("rain barrel"), ranging from 55 gallons to several hundred gallons in capacity, is placed near the down spout of a house and is used to collect rain water runoff from the roof of the house. The captured water is then typically used as a pure water source for plants and lawns.

b. Design Criteria

- (1) Gutters and downspouts carry water from the rooftops to rain barrels as shown on Figure 1.
- (2) Screens are required on gutters to prevent clogging.
- (3) Rain barrels should be equipped with a drain spigot.
- (4) Overflow outlet must be provided to bypass rain barrel from large rainfall events.
- (5) Rain barrel must be designed with removable, child resistant covers and mosquito screening.
- (6) Minimum rain barrel capacity equal to 1" of runoff from roof top surface area.

c. Maintenance and Inspection

- (1) Empty rain barrel after each rainfall event.
- (2) Rain barrel should be inspected annually.

13.05 QUALITY ASSURANCE

- A. Final design drawings, BMPs, SWPPPs, and SWQMPs will be sealed, signed, and dated by the Professional Engineer registered in the State of Texas responsible for their development.

END OF CHAPTER

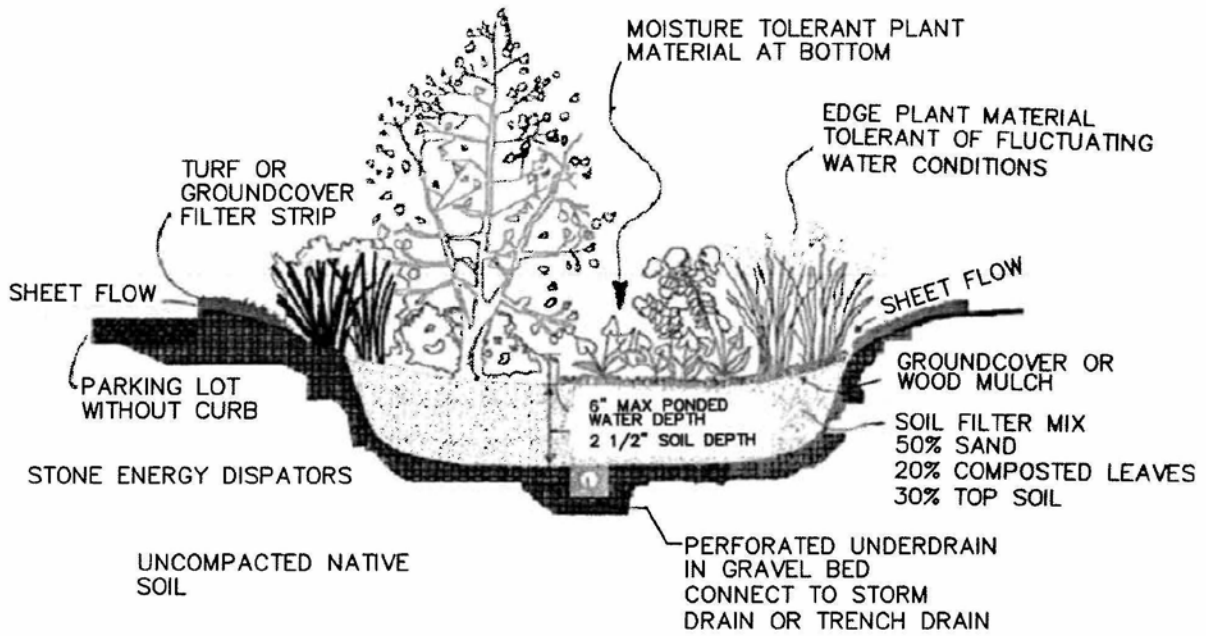

FIGURE 1
POROUS BIORETENTION BASIN

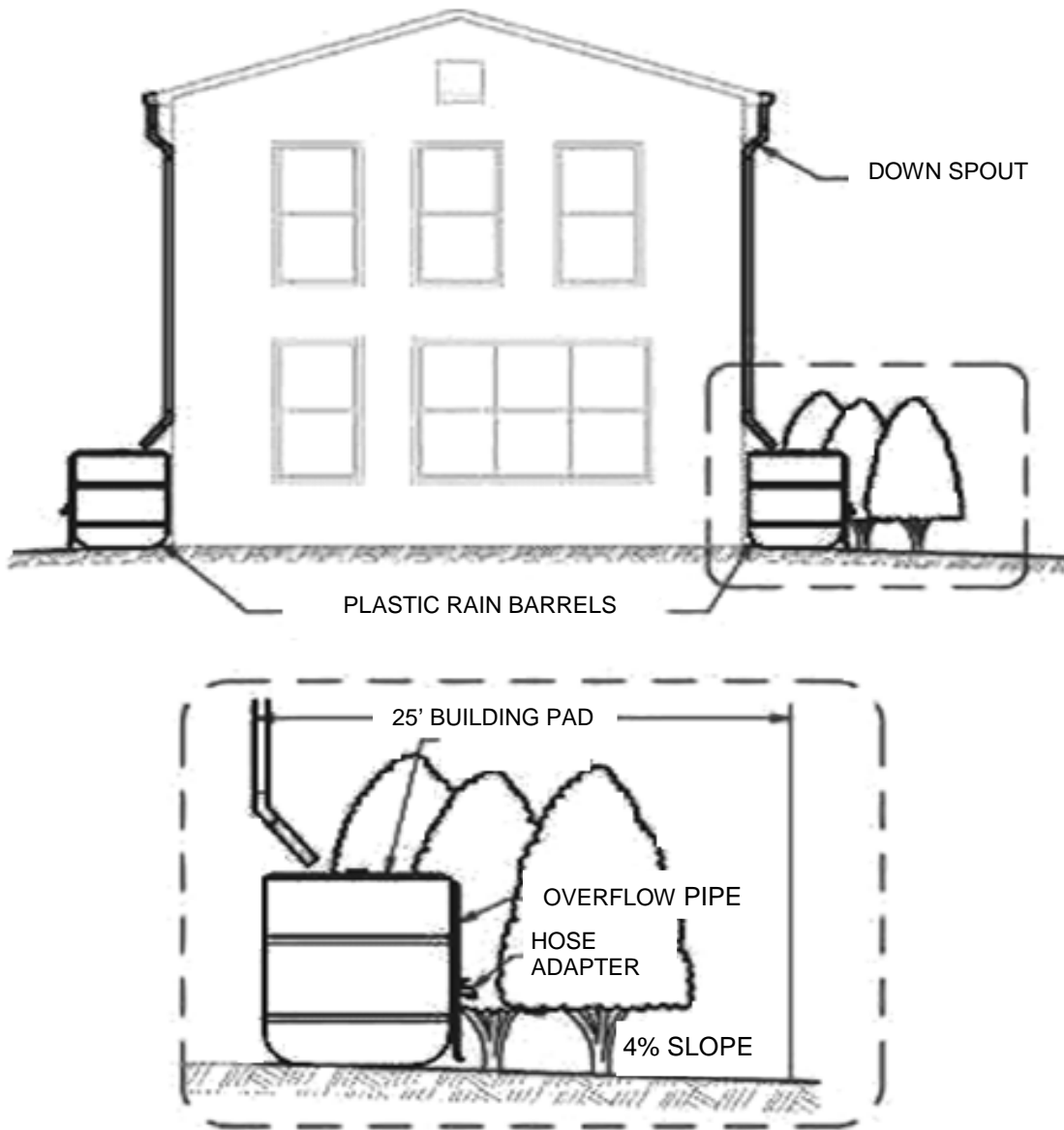

FIGURE 1
TYPICAL RAIN BARREL

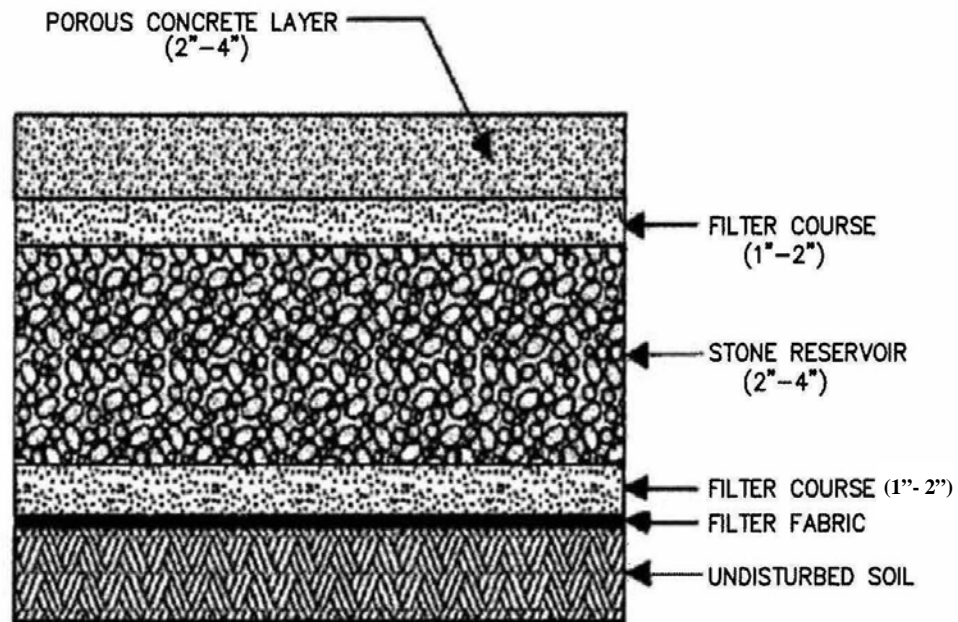

FIGURE 1
POROUS CONCRETE TYPICAL SECTION

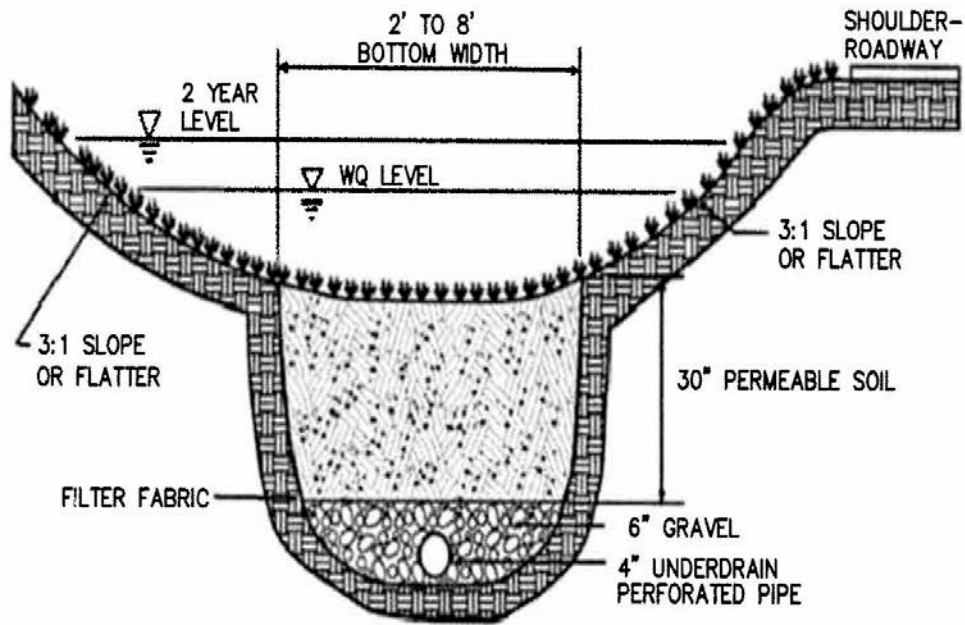

FIGURE 2
DRY SWALE CROSS SECTION

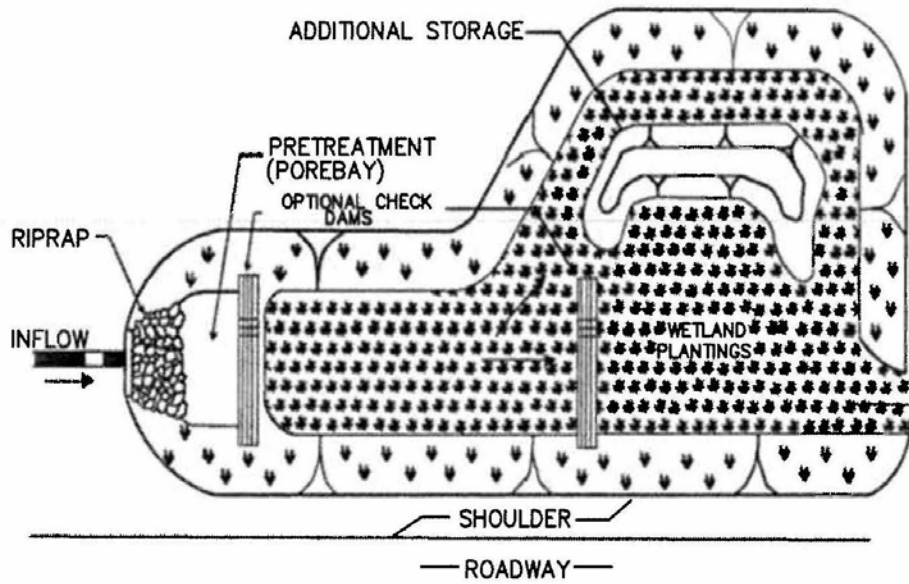

FIGURE 3
WET SWALE PLAN

City of Houston

Design Manual

Chapter 14

FACILITY DESIGN REQUIREMENTS

Chapter 14

FACILITY DESIGN REQUIREMENTS

14.01 CHAPTER INCLUDES

- A. Incorporation of Public Works and d Engineering Manuals and Guidelines for water and wastewater related facilities.

14.02 REFERENCES

- A. Groundwater Plant Design Guidelines
- B. Engineering Design Manual for Submersible Lift Stations.
- C. Drawings for Submersible Lift Stations.

14.03

- A. Conform to design requirements of the latest published edition of each reference manual.

END OF CHAPTER

City of Houston

Design Manual

Chapter 15

TRAFFIC AND SIGNAL DESIGN REQUIREMENTS

Chapter 15

TRAFFIC AND SIGNAL DESIGN REQUIREMENTS

15.01 CHAPTER INCLUDES

- A. Criteria for the design of traffic and signal requirements.

15.02 REFERENCES

- A. Refer to list of references in Chapter 1, General Requirements
- B. AASHTO - American Association of State Highway and Transportation Officials
- C. ITE - Institute of Transportation Engineers
- D. TRB - Transportation Research Board
- E. TxDOT - Texas Department of Transportation
- F. IBC - International Building Code
- G. Trip Generation, Current Edition (An ITE Informational Report, Institute of Transportation Engineers, Washington, D.C.).

15.03 DEFINITIONS

- A. **Access Management** is the systematic control of the location, spacing, design and operation of driveways, median openings, intersections, and auxiliary lanes.
- B. **ADT** is the average daily traffic volume. It represents the total two-way traffic on a street for some period less than a year, divided by the total number of days it represents, and includes both weekday and weekend traffic. Usually, ADT is adjusted for day of the week, seasonal variations, and/or vehicle classifications.
- C. **Auxiliary Lane** is a lane striped for use as an acceleration lane, deceleration lane, right-turn lane, or left-turn lane, but not for through traffic use.
- D. **Central Business District** shall mean the area beginning at the intersection of the centerline of United States Highway 59 and the centerline of Interstate Highway 45; thence in a northwesterly and northerly direction along the centerline of Interstate Highway 45 to its intersection with the centerline of Interstate Highway 10; thence in an easterly direction along the centerline of Interstate Highway 10 to its intersection with the centerline of United

- States Highway 59; thence in a southwesterly direction along the centerline of United States Highway 59 to its intersection with Interstate Highway 45, the point of beginning.
- E. **Connection Spacing** is the distance between connections, which is measured along the edge of the traveled way from the closest edge of pavement of the first access connection to the closest edge of pavement of the second access connection.
- F. **Corner Clearance** is the distance along the edge of the traveled way from the closest edge of pavement of the intersecting public or private street to the closest edge of pavement of the nearest driveway.
- G. **Design Exception** shall mean any City Engineer approved variation from the requirements of section 15.08 of this chapter.
- H. **Driveway** is an access connection constructed within the public right-of-way, used to connect a public or private street with adjacent property.
- I. **Driveway Permit** - Permit issued by the Building Official based upon Section 3110.4 of the Houston Amendments to the 2006 International Building Code or latest revisions. Driveway permits for access to Freeways, Highways, Frontage Roads, Tollways and Farm to Market Roads are not under the jurisdiction of the City of Houston. Driveway approvals from the appropriate agency with jurisdiction is required with building permit application.
- J. **Intersection Limits** shall mean the functional portion of the intersection and shall be defined as the extent or limit of turning bays located at the inters, or the limits as defined by the City Engineer.
- K. **Joint Access** See “Shared Access”
- L. **Major Activity Center** shall mean those areas designated as Major Activity Centers pursuant to Section 42-274 of the Code of Ordinances of the City of Houston, Texas.
- M. **Median** is the portion of a divided street separating opposing traffic flows. A median may be traversable or nontraversable.
- N. **Shared Access** is a single connection serving two or more adjoining lots or parcels.
- O. **Sight Distance** is the distance visible to the driver of a passenger vehicle measured along the normal travel path of a street from a designated vehicle location and to a specified height above the street when the view is unobstructed by traffic. Refer to AASHTO, Geometric Design of Highways and Streets (Current Edition), for application to specific design needs such as stopping sight distance, other sight requirements.
- P. **Storage Lane Length** is the portion of an auxiliary lane required to store the number of vehicles expected to accumulate in the lane (95th percentile queue).

- Q. **Transit Corridor** is a road along a rail corridor (non-freight) designated on the Major Thoroughfare and Freeway Plan with definition defined in Chapter 42, Code of Ordinances.

15.04 TRAFFIC STUDIES

A. APPLICABILITY

1. Two levels of traffic studies are identified and are dependent upon specific site location conditions, adjacent street configurations/capacities and traffic generation rates for proposed development. These studies are referred to as “Access Management Data” and “Traffic Impact Studies (TIA)”. Figure 15.04.01 provides an overview of the submittal and review process.
2. For each proposed development or redevelopment, an Access Management Data Summary Form (FORM A in this section) must be submitted.

Access Management FORM A provides general property information and an initial estimate of traffic volumes associated with the property.

Table 15.04.1 provides trip generation data for typical classes of development in the Houston area for weekday (ADT), peak Hour - A.M. and Peak Hour - P.M. Larger trip generation volume from A.M. or P.M. peak is of primary interest. Preparation and submittal of Access Management FORM A for review by the City can constitute compliance with the requirements of this section.

Data in Table 15.04.1 is generic in nature and specific conditions regarding a specific project may warrant more detailed calculations using ITE Trip Generation processes.

Table 15.04.1

Average Trip Generation Rates

DEVELOPMENT(3)	ITE CODE	Average Rates(1)		PEAK HOUR (A.M.)	PEAK HOUR (P.M.)	UNITS FOR 100 PEAK HOUR TRIPS
		BASIS UNIT FOR TRIP GENERATION	WEEKDAY (ADT)			
Apartments	220	Dwelling Units	6.65	0.57	0.62	150
Hotel	310	Rooms	8.92	0.67	0.70	170
General Office Building	710	1,000 SF - GFA	11.01	1.55	1.49	65
Medical Offices	720	1,000 SF - GFA	36.13	2.30	3.46	29
Specialty Retail (Strip Shopping Centers)	814	1,000 SF - GFA	44.32	n/a	2.71	37
Convenience Store (w/ gas pumps)	853	Vehicle Fueling Positions 1,000 SF - GFA	542.6	16.57	19.07	6
High Turnover (Sit Down Restaurant)	932		127.15	11.52	11.15	9
Department Store Pharmacy (w/ Drive	881	1,000 SF - GFA	88.16	2.66	10.35	10

Thru)	881	1,000 SF - GFA				
Bank (w/ Drive-Thru)	912	Drive Lanes	____(2)	9.44	27.41	4
Thru)						

NOTES: (1) Average Rates (vehicles per basis unit) Based on the 7-9am and 4-6 pm peak hours of Street Traffic. Rates based on ITE Trip Generation Rates. Specific rates for ITE Land Uses or locally developed/approved rates may be used.

(2) Insufficient data to determine an Average Daily Volumes

(3) From ITE Trip Generation, 8th Edition

- Hotels are places of lodging that provide sleeping accommodations and supporting facilities such as restaurants cocktail lounges; limited recreational facilities and retail shops. Does not include Suites Hotels, Business Hotels, Motels and Resort Hotels.
- Apartments are rental dwelling units located within same building with at least three other dwelling units with one or two levels. Does not include mid-rise or high-rise apartments.
- General Office Buildings house multiple tenants and are locations where affairs of business, commercial or industrial organizations, or professional persons or firms are conducted.
- Specialty retail centers are generally small trip shopping centers that contain a variety of retail shops and specialize in quality apparel, hard goods and services. Does not include shopping centers.
- Department stores are free-standing facilities that specialize in the sale of a wide range of products and typically maintain long hours of operation, seven days a week. Does not include free-standing discount stores, bed and linen superstores or apparel stores.
- High turnover restaurants consists of sit-down, full-service eating establishments with turnover rates of approximately one hour or less. Restaurant is usually moderately priced and frequently part of restaurant chain.

3. Exceptions to the requirements for the submittal of Access Management FORM A include:
 - a. Construction, reconstruction, remodel or additions to a single family residence.
 - b. Reconstruction or remodel of commercial developments with no change in use.
 - c. Construction, reconstruction, remodel or additions to commercial developments which add 10,000 square feet or less in building area.

4. Access Management FORM B provides additional data related to traffic conditions on adjacent roadways to the proposed project.
 - a. Access Management FORM B can be submitted with FORM A voluntarily.
 - b. FORM B may be submitted to substantiate a request not to provide a TIA as required by other sections of this chapter.
 - c. FORM B may be requested by the City to provide additional traffic volume data.

5. In addition to filing the Access Management Date Forms, a Traffic Impact Analysis may be required.

- a. If the proposed development or redevelopment generates 100 or more new peak hour trips (PHT), the Analysis Engineer should meet with the City to determine the requirement for a Traffic Impact Study.
- b. If, after discussion with the City, a Traffic Impact Study is required, the extent of the area to be studied will be determined.
- c. If an applicant submits a development plat application or building permit application for new development or redevelopment, the applicant may voluntarily submit a TIA to support the trip generation rates and access management needs to the adjacent street system for the proposed project.

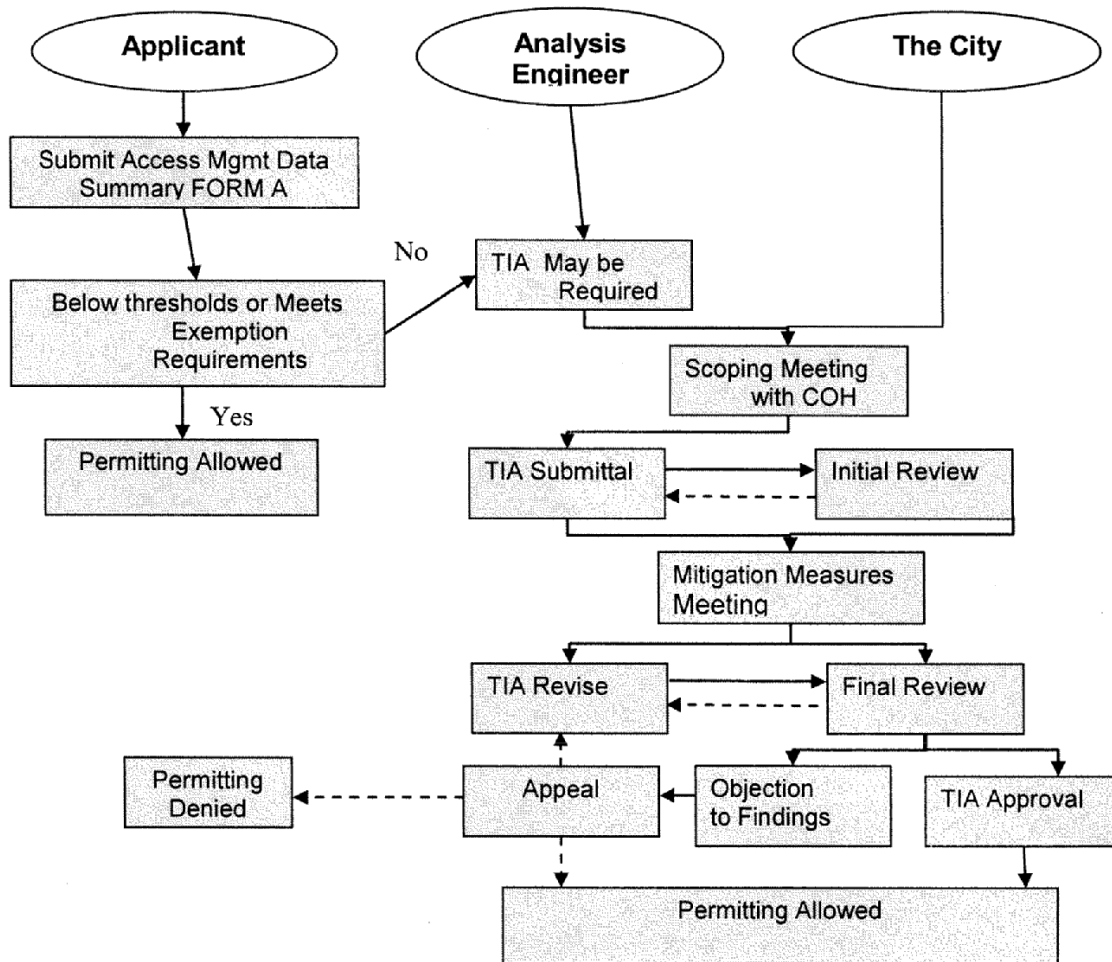

Figure 15.04.01 Overview of Traffic Impact Analysis Process



CITY OF HOUSTON
FORM A
ACCESS MANAGEMENT
DATA SUMMARY

Applicant Information:

Property Owner

Name: _____

Address: _____

City/State/Zip: _____

Telephone: _____

Email Address: _____

Agent

Name: _____

Firm Name: _____

Address: _____

City/State/Zip: _____

Telephone: _____

Email Address: _____

All responses and/or questions should be directed to (check one or both):

Property Owner

Agent

- a. Form to be accompanied by a scalable site plan layout with driveway locations indicating the extent of the access which the private property has or (is planned) to public streets. On site traffic related features (loading docks, emergency lanes, driveway entrance/exits should be depicted on site plan.
- b. Forms may be submitted at any time prior to or during Preliminary Plat submittal and Final Site Plan Permitting
- c. Results of review/analysis will result in "Interpose no objection to Permitting" or "Requires submittal and approval of additional information prior to Permitting"



CITY OF HOUSTON

FORM A

ACCESS MANAGEMENT DATA SUMMARY

SITE INFORMATION:

Street Address (Primary Access): _____

Legal Description (if no street address) _____

Key Map Page No. _____

Zip Code _____

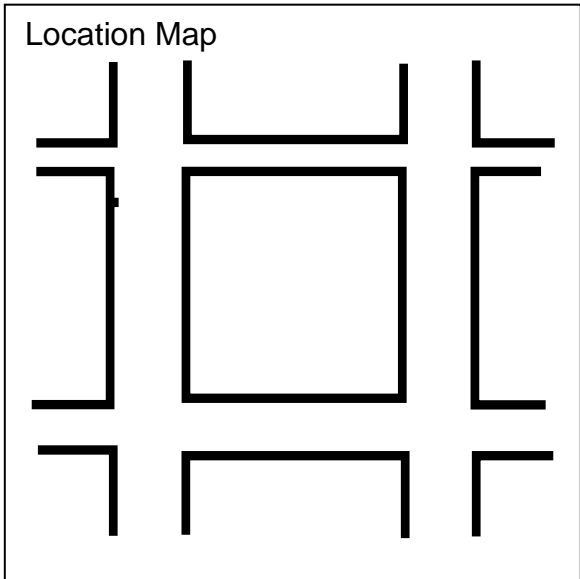

The dimensions of the private property, and the type and location of improvements thereon or to be placed thereon:

Tract Size (Sq Ft or Acres): _____

Current Land Use (include # of units, square footage of improvements, etc.) _____

Current Trip Generation Rates (Based on ITE Trip Generation Handbook or COH approved local rate)

ITE Land Use Classification: _____ AM Trip Rate: _____ PM Trip Rate: _____
(Code & Description)

AM Peak Hour Trips: _____ PM Peak Hour Trips: _____ Average Daily Traffic: _____
 (Provide Trip Generation supporting documentation as applicable.)

Proposed use to be made of the private property: (include proposed # of units, square footage of improvements, etc.) _____

Proposed Trip Generation Rates (Based on ITE Trip Generation Handbook or COH approved local rate)

ITE Land Use Classification: _____ AM Trip Rate: _____ PM Trip Rate: _____
(Code & Description)

AM Peak Hour Trips: _____ PM Peak Hour Trips: _____ Average Daily Traffic: _____
 (Provide Trip Generation supporting documentation as applicable)



CITY OF HOUSTON

FORM B

ACCESS MANAGEMENT DATA SUMMARY

Dimensions and type of construction of the street and the nature and volumes of traffic on the street on which the private property abuts:

Primary Adjacent Street:

Name: _____

Right of Way Width: _____ No. of Lanes: _____ Speed Limit: _____

Street Type/Material: _____ Pavement Width: _____

Weekday Traffic Count

AM Peak Hour: _____ PM Peak Hour: _____ Average Daily Traffic: _____

Secondary Adjacent Street:

Name: _____

Right of Way Width: _____ No. of Lanes: _____ Speed Limit: _____

Street Type/Material: _____ Pavement Width: _____

Weekday Traffic Count

AM Peak Hour: _____ PM Peak Hour: _____ Average Daily Traffic: _____

Other Adjacent Street(s) if applicable: Name: _____

Right of Way Width: _____ No. of Lanes: _____ Speed Limit: _____

Street Type/Material: _____ Pavement Width: _____

Weekday Traffic Count

AM Peak Hour: _____ PM Peak Hour: _____ Average Daily Traffic: _____

This space reserved for use by City of Houston.

C. TRAFFIC IMPACT ANALYSIS GUIDELINES (TIA)

1. General

a. Authorization to Perform a TIA

A TIA shall be prepared by an individual, group, firm, or corporation having demonstrated professional emphasis and experience in traffic engineering, and the preparation of similar analysis, hereinafter referred to as the "Analysis Engineer". The TIA document shall bear the seal and signature of a Texas Licensed Professional Engineer specializing in the branch of civil engineering. The responsibility for assessing the traffic impacts associated with a proposed development/redevelopment, hereinafter referred to as the "Development," rests with the Applicant and the Analysis Engineer, while the City shall serve as the review and approval authority.

b. Purpose and Intent of TIA Guidelines

The purpose of the TIA is to identify the adequacy of the existing street right of way to accommodate any changes in trips generated from a proposed development/redevelopment. If impacts are identified, potential mitigation measures (on-site or off-site) can be proposed and evaluated. The traffic impact analysis will be used to make a determination as to whether driveway(s) being considered are necessary to provide reasonable access to the private property consistent with the safety and convenience of the public.

c. Goals of a TIA Completed Within the City of Houston

- (1) To identify any and all potential adverse traffic impacts to the existing area street system, the surrounding community and to additional proposed developments.
- (2) To identify transportation improvements with an aim to cost effectively mitigate identified adverse traffic impacts to mobility within the study area/analysis area.
- (3) To assist public and private sector entities in identifying and resolving issues related to the location of driveways, median openings, turn lanes, traffic signals, and other transportation facilities.

d. Document Limitations

While this section (15.04) contains guidelines and requirements necessary to complete a TIA for the City, the City does not intend this section to be a sole reference for the preparation of a TIA. For more specific information regarding the various aspects of TIA preparation, the City suggests that the reader obtain and refer to the Institute of Transportation Engineer's (ITE)

current edition of Transportation Impact Analyses for Site Development
(An ITE Proposed Recommended Practice).

2. The Traffic Impact Analysis Process
 - a. The TIA report shall bear the seal and signature of a Texas Licensed Professional Engineer specializing in the branch of civil engineering. The responsibility for assessing the traffic impacts associated with a proposed development or redevelopment rests with the applicant and the Analysis Engineer, while the City shall serve as the review and approval authority.
 - b. A TIA determines traffic impacts of a development/redevelopment on the surrounding street system. The City will use this information to assist in establishing immediate transportation infrastructure needs and potential transportation improvements.
 - c. It is a goal of the City that these guidelines will allow for the maximization of efficiency and safety associated with area development/redevelopment. The City emphasizes that the TIA process can begin when the Applicant initiates development planning (i.e. prior to plat preparation).
 - d. If a TIA is required or the applicant chooses to prepare a TIA, the completed TIA may be submitted at any time between the preliminary plat submittal and final site plan approval.
 - e. Prior to submitting an application for development platting or a building permit the Applicant may be required to submit a revised TIA and obtain approval by the City if any changes have been made to the development (site plan) or original TIA assumptions related to:
 - (1) Land-use (revisions required only for an increase in trips),
 - (2) Increase in the trip generation variable(s) (revisions required only for an increase in trips),
 - (3) Intersection and street design, and
 - (4) Access connections placement and design assumptions.
3. The Proposal of Scope and Initial Trip Generation Estimate
 - a. Using proposed development or redevelopment attributes (type, size, etc.), determine a corresponding traffic impact category for the Development by calculating the highest number of estimated new peak hour trips generated for an adjacent street (See Table 15.04.02).

Table 15.4.02 Traffic Impact Categories

Traffic Impact Category	Site Traffic Thresholds New Peak Hour Trips (PHT) on Adjacent Street
Category I	PHT < 100
Category II	100 to 499
Category III	500 to 999
Category IV	PHT ≥ 1000

- b. The City requires that the Analysis Engineer generate site traffic using the methodologies found in the current edition of the ITE publication, Trip Generation (Table 15.4.01 may be used for FORM A) This includes following the “Recommended Procedure for Estimating Trip Generation”, as shown in Figure 15.4.02.

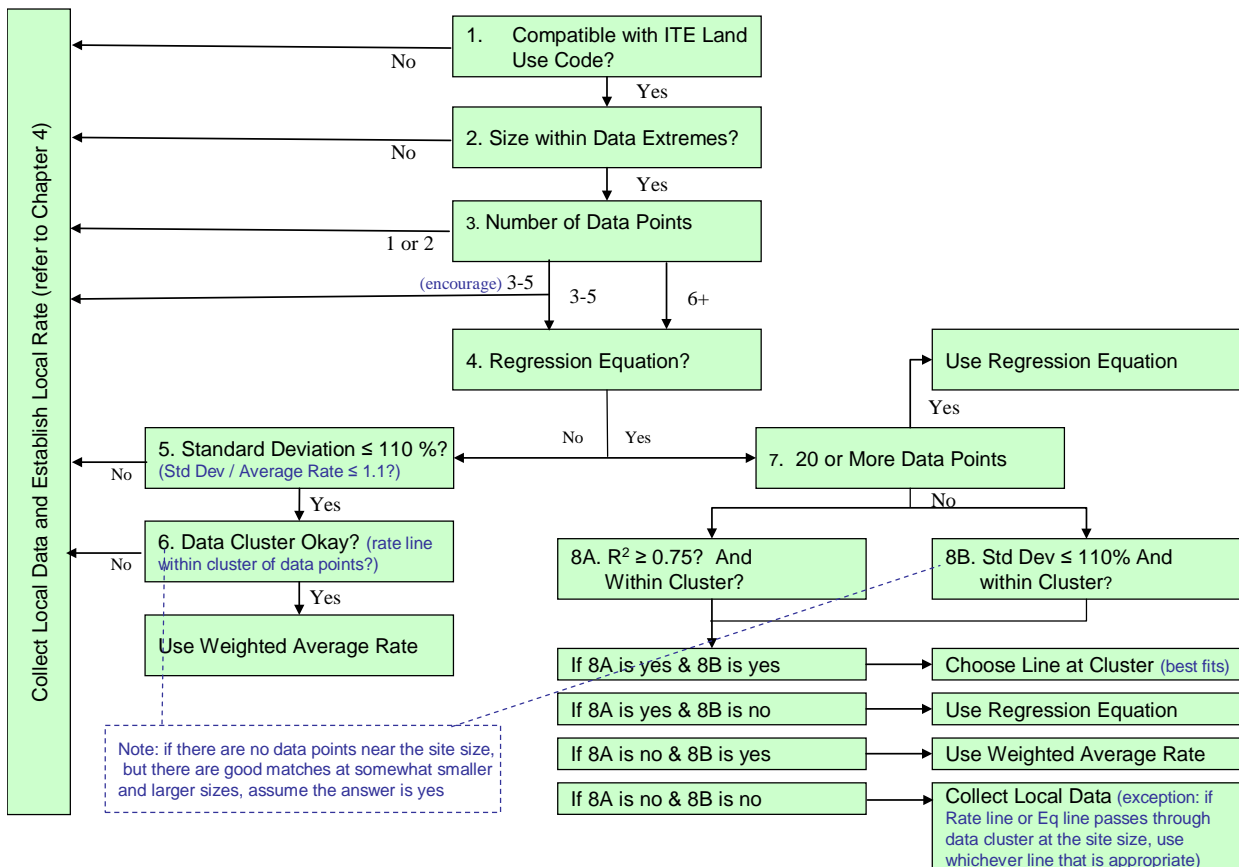

Figure 15.4.02 Recommended Procedure for Estimating Trip Generation

- c. Using the resulting traffic impact category and the Boundaries and Horizons Guidelines in Table 15.04.03, the Analysis Engineer shall prepare and submit to the City Engineer a proposal of scope for the TIA.
 - d. It is also a goal of the proposal of scope to minimize deliverables. It is mandatory that, regardless of traffic impact category (II, III, or IV), the Analysis Engineer holds a preliminary scoping meeting with the City Traffic Engineer.
 - e. An approved proposal of scope ensures that the submittal of a TIA will allow the City to evaluate the overall traffic impact of the development on area transportation infrastructure.
4. Preparing the TIA

The TIA shall be prepared according to the requirements detailed in the sections titled TIA Submission Requirements and Technical Notes (see Figure 15.04.03).

Table 15.04.03 Boundaries and Horizons Guidelines

Requirements		Category I	Category II	Category III	Category IV
General	Access Management Data Summary Form A	X	X	X	X
	Access Management Data Summary Form B		X	X	X
	Meeting with the City Traffic Engineer		X	X	X
	Proposal of Scope		X	X	X
Horizon	Opening Year		X	X	X
	Full Build-Out Year			X	X
Limits	Analysis Area (From boundaries of development) ⁽¹⁾		¼ Mile	½ Mile	½ or 1 Mile
	All Site Access Driveways		X	X	X
	All Site Access Private Street Intersections		X	X	X
	All Adjacent Signalized Intersections		X	X	X
	All Adjacent Major Unsignalized Intersections		X	X	X
	All Analysis Area Signalized Intersections			X	X
	All Analysis Area Major Unsignalized Intersections			X	X

(1) Category II, III and IV studies should extend to first signalized intersection (minimum) even if outside of Boundary and include any critical intersections.

5. TIA Submission and Review

- a. All TIA submittals should be addressed to the Office of the City Engineer. Paper copies should be submitted through the Office of the City Engineer, 2nd floor of 1002 Washington Avenue, Houston, TX. Electronic copies should be emailed directly to the Office of the City Engineer.
- b. The Applicant shall submit to the City two (2) paper copies and one electronic copy. In addition, one electronic version of the TIA appendix is required (paper copies of the appendix are not necessary unless requested by the City).

Figure 15.04.03 Traffic Impact Analysis Preparation Overview

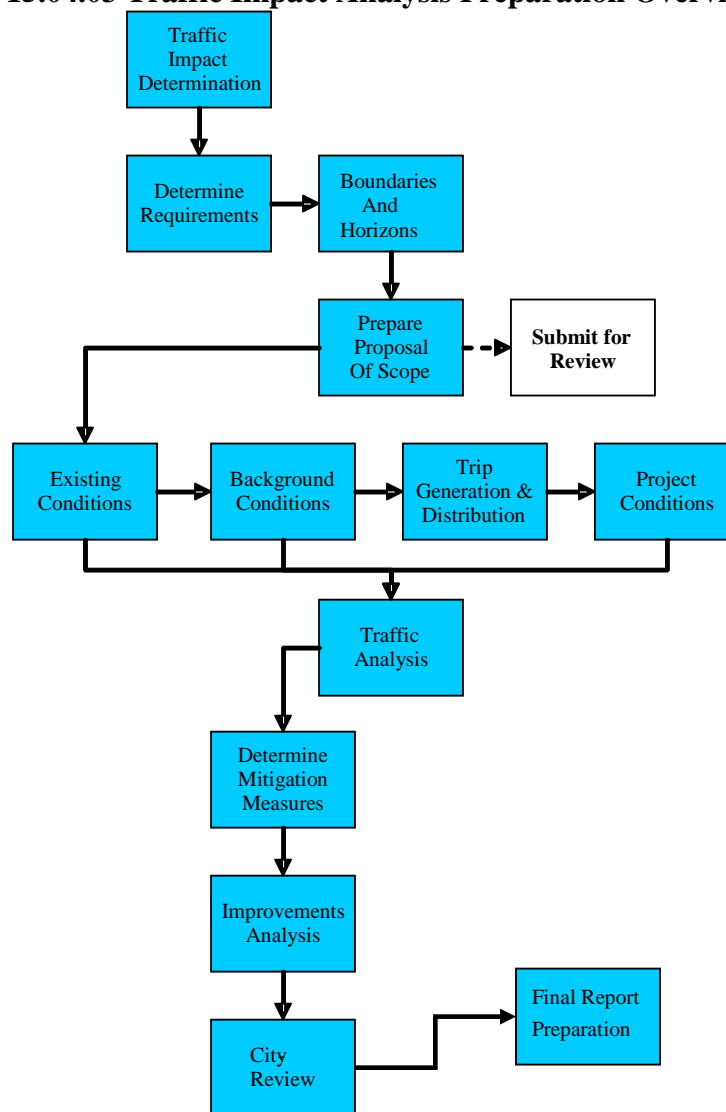

- c. The City will make an initial review of the TIA to determine if the Analysis Engineer completed the TIA in accordance with the technical requirements and within the submission requirements of the analysis as outlined in this manual or as established at the preliminary scoping meeting or proposal of scope. If the City finds deviations from the technical requirements and/or the submission requirements of the study, the City will terminate the initial review until the Analysis Engineer has addressed said deficiencies. At such a time when the City identifies deficiencies, the City will develop a notice of deficiencies and submit the notice to the Analysis Engineer and Applicant. Submittal should include, if available, electronics copies of traffic counts and other collected data (i.e., queuing, delay studies, etc.) as well as any traffic analysis models used and reference in the TIA.
 - d. All TIA submittals should include either an interim seal or a final seal, which is signed by a Licensed Professional Engineer in the State of Texas.
 - e. Upon the Applicant submitting a final TIA that meets the technical and submission requirements established in this document or at the preliminary scoping meeting or proposal of scope, the City will conduct a final review of the TIA.
 - f. Following the City's completion of the final review, the City will provide to the Analysis Engineer and Applicant written objection to the findings or adequacy of the proposed mitigation measures to address impacts. If no objections are noted, the City will interpose no objection to permitting for the proposed development. If the Applicant disagrees with the objections made by the City, the Applicant may write an appeal to the Director of Public Works.
 - g. Approval of a TIA will be considered to remain valid for a minimum of five years (from date of final TIA approval). Validity of an approved TIA beyond five years will be allowed by the City Engineer so long as the phased development is proceeding according to the approved plan and the schedule contained within such approved plan. The applicant may be required to update traffic impact data to address changes within the area and will meet with the City Engineer prior to the expiration of the five-year period in order that the City Engineer may determine if an updated TIA is required.
6. Mitigation Measures Requirements.
- a. The TIA shall have identified significant adverse traffic impacts in order to trigger the need for mitigation. The need for mitigation is determined by using the qualitative measure Level-of-Service (LOS). The threshold of significance for transportation facilities on the area street system is LOS D.

- b. Transit Corridor Streets - Chapter 42 of the City of Houston Code of Ordinances (Subdivisions, Developments and Platting) and this Infrastructure Design Manual provide planning rules and design standards to achieve multi-modal transportation corridors along designated Transit Streets.

Where a TIA for proposed development along a Transit Corridor Street is required by this chapter, it shall include trip generation estimates in accordance with guidelines presented in Figure 15.4.02. The TIA shall include a summary of estimated trips by applicable transportation categories. Transportation categories may include automobile, truck, transit, bicycle and pedestrian. Trip allocations shall be supported by documentation including data from local planning agencies, records of actual ridership from local transit agencies, statistical data from similar projects in other locations, standards from professional organizations, and other applicable resources. Where the existing, background or projected conditions are LOS E or F and existing physical conditions limit available mitigation measures, the Analysis Engineer shall meet with the City Engineer to review probable community impacts and possible mitigation measures, if any. Approval of TIA's along Transit Corridor Streets may not be withheld where all reasonable and feasible access management and offsite mitigation measures in the public street right of way have been exhausted. Access management and offsite mitigation measures may include the installation of turn lanes and/or additional lanes of traffic such as deceleration lanes, the installation of traffic signals, the construction of traffic control features or medians, and/or limitations on the number of driveways.

- c. Major Thoroughfares - Chapter 42 of the City of Houston Code of Ordinances establish roadways to be classified as Major Thoroughfares by inclusion on the Major Thoroughfare and Freeway Plan (MTFP). Major Thoroughfares are roadways designed to allow for access from large traffic trip generators and move traffic between adjacent activity centers. Projects in Traffic Impact Categories II, III and IV (see Table 15.4.02) along Major Thoroughfares are expected and fostered because of the traffic carrying capacity. Similar to a Transit Corridor Street, where the existing, background or projected conditions are LOS E or F and existing physical conditions limit available mitigation measures, the Analysis Engineer shall meet with the City Engineer to review probable community impacts and possible mitigation measures if any. Approval of TIA's along Major Thoroughfares may not be withheld where all reasonable and feasible access management and offsite mitigation measures in the public street right of way have been exhausted. Access management and offsite mitigation measures may include the installation of turn lanes and/or additional lanes of traffic such as deceleration lanes, the installation of traffic signals, the construction of traffic control features or medians, and/or limitations on the number of driveways.

- d. Central Business District - Boundaries of the Central Business District (CBD) are defined in Section 15.03. Development and redevelopment of the CBD are anticipated to involve high rise, large traffic generating facilities. Similar to a Transit Corridor Street, where the existing, background or projected conditions are LOS E or F and existing physical conditions limit available mitigation measures, the Analysis Engineer shall meet with the City Engineer to review probable community impacts and possible mitigation measures if any. Approval of TIA's in the CBD may not be withheld where all reasonable and feasible access management and offsite mitigation measures in the public street right of way have been exhausted. Access management and offsite mitigation measures may include the installation of turn lanes and/or additional lanes of traffic such as deceleration lanes, the installation of traffic signals, the construction of traffic control features or medians, and/or limitations on the number of driveways.
- e. Major Activity Centers are defined in Section 15.03. Development and redevelopment in Major Activity Centers is anticipated to involve high rise, large traffic generating facilities. Similar to a Transit Corridor Street or Major Thoroughfare, where the existing background or projected conditions are LOS E or F and existing physical conditions limit available mitigation measures, the Analysis Engineer shall meet with the City Engineer to review probable community impacts and mitigation measures, if any. Approval of TIAs within a Major Activity Center may not be withheld when all reasonable and feasible access management and offsite mitigation measures in the public street right of way have been exhausted. Access management and offsite mitigation measures may include the installation of turn lanes and/or additional lanes of traffic such as deceleration lanes, the installation of traffic signals, the construction of traffic control features or medians, and/or limitations on the number of driveways.
- f. The Mitigation Decision Tree for local roadways and collector streets is shown in Figure 15.04.04 below. The chart is color coded. Purple indicates acceptable levels of service A-D; yellow indicates marginal level of service E; and red indicates unacceptable level of service F. The Tree components are defined as follows:
- (1) Existing – represents the performance of the existing street network
 - (2) Background – represents the performance of the street network for a future year, “no build” scenario. Includes future volumes without the proposed development; accounts for traffic from projects under construction but not yet in operation; and includes any future improvements to the street network that are already programmed, regardless of whether the proposed development is built.

- (3) Projected – represents the performance of the street network for a future year, “build scenario”, which represents the future street volumes with the proposed development in place. Other than changes in traffic volumes, the “Projected” scenario includes the same street network conditions as the “Background” scenario.
 - (4) Mitigation – represents the performance of the future street network with the proposed development and with proposed mitigations resulting from the proposed development. Mitigation action is required for all conditions indicated in this row of the Decision Tree.
 - (5) LOS E and LOS F
 - (a) Prior to final approval/disapproval involving LOS E and LOS F, the Applicant will meet with City Engineer to review all aspects of proposed development and adjacent roadway conditions including intersection delays.
 - (b) For areas in the street system where the current LOS is E, the existing LOS must be maintained or improved after development. For example, if the LOS prior to the proposed development is E, then once the development is in place, the projected LOS must be at least E.
 - (c) For areas in the street system where the current LOS is F, the traffic impacts of the development on the streets and intersection within the analysis area shall be mitigated such that the LOS criteria do not deteriorate beyond Background Conditions.
- g. Methodology for computing each type of MOE and determining corresponding LOS can be found in the Highway Capacity Manual (HCM).

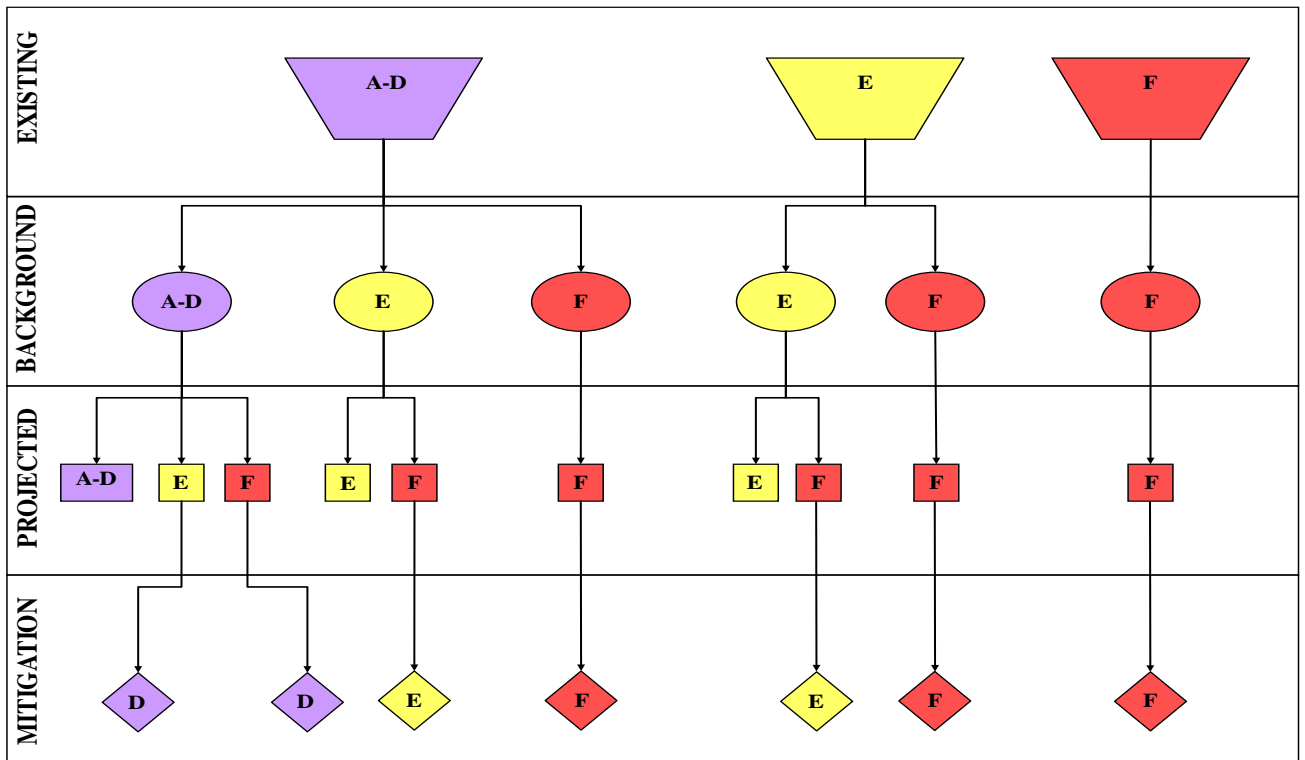

Figure 15.04.04 Mitigation Decision Tree (Collector and Local Roadways)

- h. Traffic signal retiming is not considered an acceptable mitigation measure unless it is first approved by the City of Houston Traffic Signal Operations. Typically, an individual intersection cannot be re-optimized in the future if it is a part of coordinated street network. This may only be possible if the entire street network is re-timed to allow for system wide signal progression. If signal retiming is approved by the City as a mitigation measure, it should be included in the “Mitigation” scenario.
7. Traffic Impact Analysis Submission Requirements
- a. The Analysis Engineer must identify all of the required data and information in the appropriate sections of the report.
 - b. Text contained in the document shall be comprehensive and complete.
 - c. The report shall have an electronic copy of final submittals along with the bound copy.

- d. The report shall contain a table of contents, lists of figures and list of tables.
A typical TIA report outline is shown in the following sections.

I. Executive Summary

- (a) Site Location & Analysis Area*
- (b) Development Description*
- (c) Conclusions*
- (d) Recommendations*

II. Introduction

- (a) A statement about the purpose and objectives of the analysis.*
- (b) A description of the existing and expected land use and intensity.*
 - (1) If residential, number and type of dwelling units.*
 - (2) If commercial or industrial, square footage and type.*
 - (3) If redevelopment, what is the expected trip generation differential*
- (c) A vicinity map identifying major industrial and site access intersections and other approved projects near the development.*
- (d) A site plan for the development.*
- (e) A description of development phasing and estimate year each phase will begin and end.*

III. Area Conditions

- (a) A description of the analysis area.*
- (b) A description of existing and future land uses within the analysis area. The description should include current land use, densities and occupancy, anticipated development, undeveloped properties, and current master plans.*
 - (1) If residential, number and type of dwelling units.*
 - (2) If commercial or industrial, square footage and type.*
- (c) A combination of narratives, tables and figures detailing area street system characteristics within the analysis area including:*
 - (1) Programmed street improvements in the area (City of Houston 5 year Capital Improvement Plan)*
 - (2) Additional streets that may be impacted*
 - (3) Functional Street Classifications(based upon Major Thoroughfare and Freeway Plan)*
 - (4) Posted Speed Limits*
 - (5) Distance, and alignments from existing streets, driveways, and/or median openings to development access (need to assess Access Management Standards)*
 - (6) Traffic control devices (traffic signals and Stop signs)*
 - (7) Signal locations and timings (offsets need to be shown if in coordination)*
 - (8) Intersection layout, lane usage, and street configuration*
 - (9) Street right-of-way widths*
 - (10) Lane widths*
 - (11) Current traffic volumes within the past 1 year to have been captured on a typical Tuesday, Wednesday, or Thursday for all streets in the analysis.*

Any traffic volumes older than 1 year may not be acceptable and will need to be justified. The Analysis Engineer should also make every reasonable effort to count traffic that accurately reflects a true “peak period” for the area, which includes any potential seasonal variations (i.e. schools, churches, etc.). Depending on the type of development, it may also be necessary to capture volumes on a typical weekend.

- i. 24 hour counts at major intersection and site access intersections.*
- ii. Turning movement counts (Peak Hours).*
- (12) Pedestrians and Bikes (If Applicable)*
 - i. Facilities*
 - ii. Volumes*
- (13) Transit Service (If Applicable)*
 - i. Major Transit Stops*
 - ii. Ridership (where applicable/when available)*
 - iii. Routes and Service Intervals*
- (14) Crash Analysis (if Applicable) over the past 3 years, including number and types of crashes as well as severity of injuries.*
- (15) Existing sight distances – Intersection and stopping sight distances, vertical and horizontal clearances. Refer to Chapter 10, Section 10.06.B.3. Intersection Sight Distance.*

IV. Required Table(s)

- (a) Twenty-four hour approach volumes at major and site access intersections.*
- (b) Peak Hour approach volumes at major and site access intersections*

V. Required Figure(s)

- (a) Major and site access intersection lane configuration diagrams with existing Twenty-four hour approach volumes. Preferably overlaid onto aerial photography.*
- (b) Major and site access intersection lane configuration diagrams with existing AM and PM peak hour turning movement volumes. Preferably overlaid onto aerial photography.*
- (c) The Analysis Engineer may also use photographs (identifying location from where it was taken as well as the date and time stamp) to document existing conditions.*

VI. Projected Traffic

- (a) Sufficient details of calculations so that all calculations can be verified.*
- (b) Site generated traffic volumes (24-hour and peak periods) by corresponding development phase or year.*
- (c) Trip Generation - List of trip generation rates and/or sources of rates used for the study.*
- (d) Trip Distribution and Assignment - The gravity model or other acceptable trip distribution model used to estimate trip distribution. The Analysis Engineer can complete this task either manually or with applicable computer models.*

- (1) *Background traffic volumes (24-hour and peak periods) by corresponding development phase or year.*
- (e) *Traffic Volumes should account for all approved developments in the analysis area as well as area growth beyond the analysis area. Contact the City for information about surrounding developments.*
 - (1) *Pass-by and diverted traffic volume reduction rates, if applicable.*
 - (2) *Pedestrian, bicycle and transit reduction rates, and supporting evidence, if applicable.*
 - (3) *Internal capture reduction rates, if applicable.*
 - (4) *Total project traffic volumes (24-hour and peak periods) by corresponding development phase or year. Future traffic as may be required for a development with multiple phases should also be included.*
- (f) *Required Table(s)*
 - (1) *Pass-by trip, internal capture, pedestrian, bicycles, and transit reduction rates used, if applicable.*
 - (2) *Twenty-Four hour approach volumes for background, pass-by, site generated, and total project traffic conditions at major and site access intersections and any additional transportation facilities specified by the City.*
 - (3) *Peak Hour approach volumes for background, pass-by, site generated, and total project traffic conditions at major and site access intersections and any additional transportation facilities specified by the City.*
- (g) *Required Figure(s)*
 - (1) *Twenty-Four hour, and peak hour approach volumes for background, pass-by, site generated, and total project traffic conditions overlaid onto major and site access intersections lane configuration diagrams. Preferably overlaid onto aerial photography.*
 - (2) *Peak hour turning movement volumes for background, pass-by, site generated, and total project traffic conditions overlaid onto major and site access intersections lane configuration diagrams. Preferably overlaid onto aerial photography.*
 - (3) *Distribution and assignment rates for pass-by and site generated traffic volumes overlaid onto major and site access intersections lane configuration diagrams. Preferably overlaid onto aerial photography.*

VII. Traffic Analysis

Analyze existing, background and project Traffic Conditions LOS and Delay at all major and site access intersections and determine MOEs of any additional transportation facilities within the analysis area as necessary or as specified by the City.

- (a) *Analysis must utilize existing traffic volumes.*
- (b) *Analysis must utilize total projected traffic volumes which include site generated traffic and the background traffic to complete analyses for the required study limits and horizons as they correspond to the predetermined TIA category.*
- (c) *Analysis may be prepared manually or by using various software programs such as Highway Capacity Software, Synchro or as approved by the City.*

- (d) Analysis must utilize the capacity analysis methodology found in the current edition of the Highway Capacity Manual, or control delay calculations from Synchro or other software as approved by the City, and/or delay calculations from micro-simulation of the complete street network (no individual intersections) to determine LOS.
- (e) Determination of necessary or specified MOEs should be completed using state-of-the-practice engineering methods.
- (f) In addition to LOS and delay, the Analysis Engineer should identify critical movements regarding capacity and potential locations of queue spillback.
- (g) The Analysis Engineer should perform a signal warrant analysis for unsignalized intersections (engineering judgment) using the signal warrant guidelines. Additionally, as part of the improvements analysis the Analysis Engineer should analyze any unsignalized intersections warranting a signal as a signalized intersection and discuss within the TIA report.
- (h) Tables of existing, background and project traffic conditions LOS and delay for each major and site access intersection and MOEs for any additional transportation facilities specified by the City, include critical movements and queue spillbacks.

VIII. Additional Information (If Applicable)

- (a) Site circulation and off-site parking requirements.
- (b) Potential parking impact to adjacent neighborhoods and neighborhood parking
- (c) Evaluation of potential need for traffic calming including bulb out, chicanes, roundabouts, or those elements found in Section 15.19 of this chapter.
- (d) Others (If Applicable)
 - (1) Crash Analysis
 - (2) Traffic control needs
 - (3) Transit
 - (4) Pedestrian and bicycle access
 - (5) Delivery and service vehicles
 - (6) Transportation demand management.

IX. Transportation Improvements Analysis (Mitigation Measures)

- (a) A description and justification of needed transportation improvements to accommodate project traffic conditions
- (b) LOS and Delay evaluation and comparison including review of critical movements and queue spillbacks
- (c) MOE comparison for any additional transportation facilities specified by the City
- (d) Table(s)
 - (1) LOS and Delay comparisons for improvements including critical movements and queue spillback
 - (2) MOE comparisons for any additional transportation facilities improvements
- (e) Figure(s)
 - (1) Concept schematics of improvements including corresponding LOS and Delay values.

X. Site Improvement Analysis

- (a) *A description of site circulation and recommendations for improvement.*
- (b) *A description of on-site parking and recommendations for improvement including shared parking, if applicable*
- (c) *A description of expected delivery and service vehicle operation and facility use and recommendations for improvement.*
- (d) *A description of expected site passenger loading characteristics and recommendations for improvement.*
- (e) *A description of adherence to related access management concepts as can be found in the City's set of Access Management Standards including driveway design, access spacing, and turning movement treatments.*

XI. Conclusions and Recommendations

- (a) *Traffic Impacts*
- (b) *Adjacent transportation improvements for each horizon year addressing, at a minimum, the following*
 - (1) *Traffic control device(s) (modification or installation)*
 - (2) *Additional capacity (left, right, or through lanes)*
 - (3) *Need for acceleration or deceleration lanes*
 - (4) *Critical movements*
 - (5) *Length of storage bays*
 - (6) *Implementation schedule*
- (c) *Off site transportation improvements*
 - (1) *Modification to existing traffic control device(s)*
 - (2) *Additional traffic control device(s)*
 - (3) *Additional capacity at major intersections*
 - (4) *Additional street capacity*
 - (5) *Other*
- (d) *Site transportation improvements*
 - (1) *Access Management*
 - (2) *Site circulation and parking*
- (e) *Mitigation Measures*
 - (1) *The TIA report shall identify the mitigation measures needed as a result of any traffic impacts of the proposed development or redevelopment. The TIA report should also identify who or what exactly caused the need for each mitigation measure. This information will be used when the Applicant meets with the City Engineer about the implementation and cost appropriations for mitigations measures.*

XII. Appendices

Appendices may be included as an attached CD having individual electronic file folders for each appendix and appropriately titled Adobe PDF files.

- (a) *Basic Trip Generation Worksheet*
- (b) *Capacity Analysis Worksheets or Modeling Software Output*

- (c) *Traffic Volumes (24-hour and peak hour turning movement counts)*
- (d) *Selected Photographs*

D. TECHNICAL NOTES

1. **Background Trip Determination**

Background or non-site traffic forecasts are necessary to determine the impact of the development in horizon years such as the projected year of opening, year of full build-out and five years after full build-out. Background traffic consists of all trips that do not begin or end in the analysis area and all attraction and production trips from existing development within the analysis area. Trips generated from existing development within the analysis area are important as the proposed development may influence existing traffic patterns and potentially generate new trips for existing developments. Background traffic volumes should also include trips generated from other proposed developments within the analysis area. The Analysis Engineer should check with the City to ensure that all approved developments have been included in background traffic determination.
2. **Methodologies for Background Traffic Determination**
 - a. There are three basic methodologies used to determine background traffic volumes: build-out, area transportation planning, and trending. Each of these methodologies has strengths and weaknesses. Some methods may be more appropriate depending on the category of the Development. The Analysis Engineer may use any of the three aforementioned methods to determine background traffic volumes. The City anticipates that the majority of background traffic calculations will be completed using trending methods. For this reason, the City provides the following information on trending.
 - b. Trending or the use of growth rates is a common method used to generate background traffic. This method is particularly useful for smaller developments and studies having shorter horizon periods (5 to 10 years). City of Houston traffic volumes have typically grown between one and two percent per year. Although these growth rates are typical for the whole of the City, there are some areas that may have higher and lower rates of growth. The Analysis Engineer may find higher growth rates in outlying areas of the City having lower development density, and lower growth rates in older more mature areas of the City that have little or no year-to-year changes in traffic. In general, the City of Houston experiences a growth rate of one percent for all trending analyses. It is a requirement and the responsibility of the Analysis Engineer to apply appropriate growth rates as they correspond to different areas of the city. The Analysis Engineer should provide and justify an expected area growth rate in the proposal of scope for approval by the City.
3. **Site Trip Generation**

The City requires that the Analysis Engineer generate site traffic using the methodologies found in the current edition of the ITE publication, Trip Generation Handbook. This includes following the “Recommended Procedure for Estimating Trip Generation”, as shown in Figure 15.04.02. General Trip Generation Rates in Table 15.04.1 may be used to prepare FORM A.

The ITE publication suggests using rates from local studies as a preferred method for generating site traffic. If the Analysis Engineer utilizes local studies to determine appropriate rates, it is a requirement and the responsibility of the Analysis Engineer to reference these studies in the TIA report. In addition, the Analysis Engineer must make available copies of the referenced studies if requested by the City. If local rates are not available, the Analysis Engineer shall use equations and rates from the current edition of the ITE Trip Generation report as long as it follows the ITE Recommended Procedure, as shown in Figure 15.04.02. Otherwise, Analysis Engineer should consult with the City and local data may need to be collected

4. Pass-by Trips / Internal Capture
 - a. The City Traffic Engineer shall approve all pass-by and internal capture reduction for use in the TIA.
 - b. The added pass-by trip will have little impact on through movement traffic operations or be part of a potential change in travel demand requiring adjacent transportation infrastructure improvements. However, the City recognizes that pass-by trips can affect left- and right- turning movement frequency and may require installation of turn lanes or other forms of mitigation (i.e., exclusive phasing, timing optimization, capacity increase). The Analysis Engineer should redistribute pass-by trips from the through movement to the appropriate left- or right- turning movement for analysis purposes. The Analysis Engineer should provide and justify an expected reduction rate for pass-by trips in the proposal of scope for approval by the City.
 - c. Development access connections should still carry pass-by trips and the Analysis Engineer should consider those trips in calculating the total number of trips generated by the proposed development and for necessary adjacent street improvements due to these trips. The City also recommends that the Analysis Engineer account for pass-by trips in the trip assignment step to ensure appropriate left and right turning movement volumes as these added turning vehicles may require the need for the installation of new or additional storage at existing left- and right-turn lanes.
 - d. Internal capture is the application of a percent reduction in generated trips (driveway trips) and is typically applicable to projects such as shopping centers with out-lots.

5. Generating Trips for Redevelopment
 - a. For proposed redevelopment, the City allows the Analysis Engineer to subtract trips generated by the existing development from those the new development will generate.
 - b. If an Applicant proposes changes to only a portion of an existing development, the City allows the Analysis Engineer to subtract any trips associated with that portion of the existing development from the trip that the proposed redevelopment will generate.
6. Site Trip Distribution and Assignment
 - a. Site traffic distribution and assignment are very subjective tasks and requires the Analysis Engineer to exercise engineering judgment and to call on past experiences in transportation planning.
 - b. Trip Distribution
 - (1) Trip distribution efforts, in general, take into consideration the Development as a whole. Determining how generated traffic will access the proposed development can vary greatly and depends on several factors:
 - (a) Type of development
 - (b) Size of the development
 - (c) Where the development will draw or attract traffic from
 - (d) Competing developments in the area
 - (e) Surrounding land uses
 - (f) Condition and capacity of the surrounding street system
 - (2) The City recommends the Analysis Engineer refer to, or utilize previously determined trip distribution models, planning software, or other recognized and substantiated methods to distribute traffic.
 - (3) It is a requirement and the responsibility of the Analysis Engineer to document the methodologies or references utilized in completing the task of trip distribution in the TIA report. The Analysis Engineer will also be responsible to provide copies of referenced studies or models if requested by the City.
7. Trip Assignment

Assigning trips determines the amount of traffic on routes within the street network and analysis area. The Analysis Engineer should assign trips after considering several area and street network characteristics such as logical routings, left-turn movements at unsignalized intersections and access connections, available capacity and existing travel times. The Analysis Engineer should consider traffic conditions for each horizon year and adjust trip assignments accordingly. The Analysis Engineer

may also find it necessary to prepare different sets of trip assignments for site generated trips. This may especially be useful if there are a significant number of pass-by trips. It is a requirement and the responsibility of the Analysis Engineer to detail and explain assumptions in the narrative portion of the TIA report.

8. Traffic Analysis

- a. Capacity analyses shall be performed on the transportation facilities within the determined analysis area. The Analysis Engineer shall use the methodology of the HCM to complete any capacity analysis. The analyses may be prepared manually or by using various available software programs such as HCS, Synchro, or as approved by the City. In addition to capacity analyses, the Analysis Engineer should consider other factors including safety, circulation, traffic control needs, transit, neighborhood traffic impacts, pedestrian and bicycle access, delivery and service vehicles and transportation demand management.
- b. For each analysis horizon, the Analysis Engineer shall utilize the total project traffic volume which includes site generated traffic and the background traffic. Background traffic shall include traffic from other proposed developments within the analysis area and horizon. The Analysis Engineer shall also complete capacity analyses for existing and background conditions in order to provide LOS comparisons.
- c. The analysis and site plan of the Development are an iterative process necessary for each horizon year. The purpose is to show the relationship between the site, its circulation, and plan along with the existing area street system. Accomplishing this allows the Analysis Engineer to better determine deficiencies and develop alternatives for consideration. The Analysis Engineer should define and identify impacts, deficiencies, and need for improvement. The analysis of existing conditions is essential in order to determine pre-development deficiencies and need for improvements.
- d. The Analysis Engineer shall tabulate and report LOS and Delay for the transportation facilities within the determined analysis area. The Analysis Engineer should tabulate overall intersection LOS and delay for each approach and individual movements. The City recognizes that left turning movements and in many cases, the approach LOS may be less than desirable at stop-controlled facilities. Intersection capacity analysis shall include analysis of queue spillbacks and capacity of left and right turn lanes. The LOS for turning movements at all access connections (driveways and turning lanes) at the project site shall also be analyzed.

- e. If the Applicant is proposing a traffic signal at an intersection or access connections, the Analysis Engineer shall use the warranting process prescribed by the City's Signal Engineering Section Design Guidelines.
 - f. All capacity analysis worksheets and modeling software outputs for the existing conditions and horizon years shall be included in the TIA report as an appendix. The City may also require the actual model to be submitted in electronic form.
9. Site Access and Off-Site Improvements
- a. The Analysis Engineer should identify needs and deficiencies using the previously prepared analyses. In addition the Analysis Engineer should develop alternatives to address these needs and should address both on- and off-site improvements, if applicable.
 - b. Mitigation measures can include, but are not limited to, median openings, turn lanes, traffic calming and traffic signals. The Analysis Engineer shall analyze proposed mitigation measures for capacity and other factors. The Analysis Engineer shall base capacity improvements on the LOS.
10. Previously Proposed Transportation Improvements
- The Analysis Engineer can factor proposed network improvements into the analysis and can use them as mitigation measures. For example, if the Applicant schedules a Development to open in three years, and the City has a capital project that will widen the street before that time, the Analysis Engineer can consider the proposed capital improvement in the analysis.
11. Phased Developments
- a. Phased Developments often present a challenge for the Applicant. In many cases, Phase I of the development is well defined while additional phases are vague and may change with market conditions.
 - b. It is acceptable to the City for an Applicant to submit a TIA for all phases of the Development including proposed improvements at the start of a project. However, if future phases of the Development change, generating more traffic than what the Applicant had previously submitted to the City, it will be necessary for an Analysis Engineer to update the existing TIA or prepare a new one. If the Applicant only submits to the City the first phase of the Development, the Applicant should be aware that conditions may change potentially requiring additional on- and off-site improvements. If a Development is to be completed in phases, the TIA can also propose phasing

of mitigation. However, the Analysis Engineer must analyze any mitigation measures proposed for the appropriate horizon year.

12. On-Site Planning

- a. An integral component of any TIA should include basic site planning. This includes the identification of access connections, internal circulation, service and delivery access connections and service bays including the use of turning templates as appropriate, and the identification of optimal building locations.
- b. Access connections operate as intersections and the City treats them as such. They should have an appropriate number of lanes, adequate storage, pedestrian facilities and appropriate signing and pavement markings. Adequate storage for a larger Development's access connections is often a concern, and if not designed properly, will operate inefficiently creating the potential for traffic to back up onto the street system. Joint access between adjoining properties is desirable; particularly where street frontages are short or internal volumes will be low. Driveways should be located near the property line if possible or the Applicant should make cross access agreements with adjoining property owners.
- c. On-site circulation and street design should be consistent with off-site streets. The area street system has shaped driver behavior and expectations; violating these expectations provides potential for safety problems.
- d. Consistency between off-site and on-site signage and pavement markings is desirable for managing drivers' expectations. To the extent practical, use of Texas Manual on Uniform Traffic Control Devices (TxMUTCD) approved signs and pavement markings is recommended. Site access connections shall conform to City of Houston Access Management Standards and the Applicant and the Analysis Engineer should consider the following principles:
 - (1) Locating proposed traffic signals to provide for progression along the intersecting street.
 - (2) Providing the minimum number of access connections that can adequately serve all anticipated traffic traveling to the site.
 - (3) Providing adequate capacity/storage at access connections to ensure that traffic accessing the site does not spill back onto adjacent streets.
 - (4) Intersecting two-way driveways with streets as close to perpendicular as possible.
 - (5) Providing adequate capacity/storage at internal intersections, especially those adjacent to public street access connections, to ensure that traffic within the site does not spill back onto adjacent streets.
 - (6) Providing adequate sight distance and appropriate safety measures at all access connections and internal intersections.
 - (7) Locate site driveways across from existing public streets, driveways or

existing median break locations, i.e., avoid offset driveways or access connections.

- e. The Analysis Engineer should base storage lengths at access connections on the City of Houston Design Manual and Access Management Standards. For smaller developments, the Analysis Engineer should design parking and access connections to allow vehicles to align themselves perpendicularly to the adjacent street system. For larger developments, the Analysis Engineer should provide adequate storage to ensure that exiting traffic does not hinder internal circulation.

E. Traffic Analysis in Major Activity Centers

The City Engineer, together with the Planning and Development Department, may cooperate with management districts, development authorities or other public or private organizations to prepare a transportation plan within a Major Activity Center. While the City may provide oversight, the preparation of the plan is not the responsibility of the City.

1. Transportation Plan and Traffic Analysis

- a. The horizon year projections can be used to generate trips for the Major Activity Center study area. A Traffic Impact Analysis can be prepared using this transportation plan identifying impacts and mitigation measures. A plan can be included for how mitigation measures are implemented and these can be incorporated into transportation plans and capital improvement programs within a Major Activity Center.
- b. It may be necessary for the Transportation Plan and Traffic Analysis to be updated once every five years.
- c. Any proposed development within the Transportation Plan and Traffic Analysis Study Area that will produce the same or less PHT than a use described in the Transportation Plan shall be exempt from preparing a TIA.
- d. Any proposed development within the Transportation Plan and Traffic Analysis Study Area that will produce more PHT than described in the Transportation Plan shall be required to amend the Plan or submit a separate stand alone TIA.

2. Developments within a Major Activity Center without a Transportation Plan and associated Traffic Analysis that would ordinarily require a TIA will still require a TIA in order to determine the impacts of the development and mitigation measures, if any, required.

3. Developments within a Major Activity Center will always have the option of

preparing a separate TIA specifically for their development.

15.05 RESERVED FOR TRAFFIC VOLUMES

15.06 SCHOOL ZONE POLICIES

15.06.01 GENERAL

- A. The City of Houston, Public Works and Engineering Department, Traffic Operations Division has an ongoing Schools Coordination Program where the City works with school principals or their designated representatives to develop a master plan for creating safe and efficient school zones which balance pedestrian safety and roadway mobility needs.
- B. School speed zones are installed where students cross or are likely to cross roadways by themselves but may not have a level of mental cognizance to do so safely.
- C. As the school's principal is in overall responsible charge for all activities associated with a school, the City does not respond specifically to requests from the community at large but do present any suggestions received to the principal for consideration.
- D. All proposed changes or new school zone requests shall be referred to the School Coordinator, at 832-395-3000. In addition, detailed School Zone Policy can be obtained at <http://www.publicworks.houstontx.gov/traffic/programs.html>.

15.06.02 DESIGN REQUIREMENTS ON ROADWAYS WITH EXISTING SCHOOL ZONE

A. Description of Design/Review Process

1. Project Initiation

- a. The Consultant shall meet with the City of Houston prior to beginning the school zone redesign/replacement to discuss the project in detail. At this meeting, typical and any specialty school zone issues within the project limits will be discussed. The meeting regarding school zone will generally occur as part of other project initiation meetings and will not require a separate meeting.

2. Collect School Zone Data and Design

- a. Collect all data required to develop existing school zone items including but not limited to school zone beacons, designated school crossings, and school start time and dismissal time. Typically, school zone information will be included as part of the general existing condition data collection effort.

- b. The Consultant shall prepare a plan to maintain existing school zones in safe operational manner if school is in session during construction and replace existing school zones as implemented previously before start of construction or modification as recommended by City of Houston.

15.06.02 EXISTING SCHOOL ZONES DURING CONSTRUCTION

- A. It is the responsibility of the Contractor performing the work to accommodate safe movement of school related activities during the entire duration of the construction period.
- B. The Contractor may need to relocate school beacons, school zone signs temporarily during construction before implementation of school zone equipment per design plans at the Contractor's expense.

15.07 RESERVED FOR STREET EXTENSIONS.

15.08 ACCESS MANAGEMENT STANDARDS

A. APPLICABILITY

1. The Access Management Standards contained in this section are applicable to each development, all or a portion, which is located within the defined corporate city limits of the City of Houston, Texas.
2. The requirements contained within this section are design standards and will serve as a basis for development plat approvals and building permits. These standards should be used in conjunction with the Houston City Code of Ordinances and other requirements set forth in the Infrastructure Design Manual.
3. Requirements for Access Management Design Techniques - Additional references/resources are available in Chapter 40 – Streets and Sidewalks of the City of Houston Municipal Code of Ordinances and the Houston Amendments to the 2003 International Building Code;
<http://www.municode.com/resources/gateway.asp?pid=10123&sid=43> .

B. GENERAL

The overall purpose of implementing the City of Houston Access Management Standards is to enhance the functionality of City streets. This enhancement will be accomplished through preservation and improvement of operational efficiency and safety. "Access Management" is the systematic control of the location, spacing, design, and operation of driveways, medians, auxiliary lanes, and intersections in order to improve the balance between access and mobility while preserving street efficiency and safety.

C. ACCESS MANAGEMENT DESIGN

1. Driveways

- a. Driveways and their associated openings should be located and designed to provide reasonable access between private property and the street right of way. The driveway should not create an unmanaged traffic hazard for drivers entering the street or for drivers on the through street, nor negatively impact normal use of street right of way.
- b. The proper location and design of a driveway should be consistent with the safety and convenience of the public and must take into account nature and volume of traffic on abutting streets, dimensions and construction of abutting streets, use of developed property, dimensions of the developed property, and type and locations of improvements to the developed property.
- c. Driveway design considers the effect of vehicles to/from developed property on the movement of traffic and the safety of traveling public on abutting streets.
- d. Driveways are based on two property classifications: single family residential and all others.
- e. Driveways to/from a property should include no more than the minimum number to provide reasonable access between the property and abutting street.
- d. Driveway width is measured at the beginning of the driveway radii tangents within the driveway (see Figure 15.08.01). Driveway Radius is the rounded edge of a driveway that permits easier entry and exit by turning vehicles. Design standards for minimum driveway width and radius can be found in Table 15.08.01.

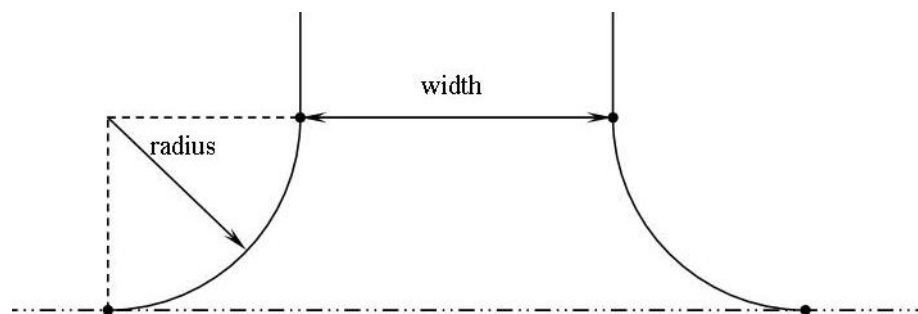

Figure 15.08.01 Driveway Radius and Width

Table 15.08.01 Driveway Design Criteria

	Single Family Residential				All Others			
	Radius (ft)		Width (ft)		Radius (ft)		Width (ft)	
	Max	Min	Max	Min	Max	Min	Max	Min
Two-Way	15	4	24	12	25	10	35	24
Joint-Access	15	4	24	12	25	10	35	24
One-Way	15	4	20	12	25	10	20	15

e. Notes on Driveway Design Criteria

- (1) One-way driveways must intersect city streets between 45 and 90 degrees.
- (2) Skewed, one-way drives are permitted only on one-way streets and divided streets with no median opening.
- (3) Two-way driveways must intersect city streets at approximately 90 degrees.
- (4) Where situations permit, AASHTO design vehicles may be used to justify driveway radii.
- (5) No driveway radius shall encroach on abutting property or corner radius.
- (6) Driveways shall not be permitted within limits of any intersection. (Design exception shall be required for major thoroughfare locations with existing esplanades and streets used for residential access.)
- (7) For one-way driveways, the entry driveway shall precede exit driveways (in direction of adjacent travel lane).
- (8) Driveway must remain tangential for a minimum of 20 feet past the property line.
- (9) Where present or projected traffic operations indicate needs for alternative driveway geometrics, additional consideration may be given.

2. Driveways and Loading Docks/Wells/Berths

- a. Loading docks/wells/berths are not permitted for back-in loading from an adjacent Major Thoroughfare.
- b. Loading docks/wells/berths must be located on site to provide for approach and maneuvering on-site with appropriate space to accommodate dimensions of vehicles accessing site.
- c. Loading docks/wells/berths must be located on site such that sufficient area is available to store commercial motor vehicle, truck-tractor, trailer, or semi-trailer or combination of such vehicles within the developed property and no

part of vehicle shall protrude over the property line or obstruct any public street or sidewalk in whole or in part.

3. Driveway and Corner Clearance Spacing

The distance between connections (driveway-driveway and driveway-street) is measured along the edge of traveled way from the closest edge of pavement of the first connection to the closest edge of pavement of the second connection (see Figure 15.08.02 for residential and Fig 15.08.03 for non-residential). Driveway spacing criteria for residential areas can be found in Table 15.08.02. Non-residential driveway placement criteria for intersections is shown in Figure 15.08.03 and Table 15.08.03.

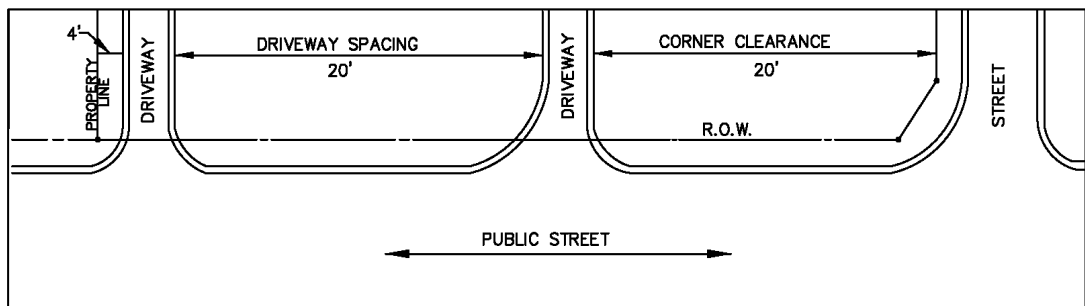

Figure 15.08.02 Driveway Spacing

Table 15.08.02 Residential Driveway Spacing Criteria				
	Between Adjacent Driveways	Between Adjacent Street ROW	Between Side Property Line	Maximum Number of Driveways
	Spacing (Minimum dimension in ft)			
Single Family Residential	20(1)	20	4	2
(1) 10 foot minimum between pair of one-way driveways (2) All proposed access connections must be placed to achieve adequate intersection sight distance for safe and efficient departure from the proposed location (comply with AASHTO standard). (3) Driveway radius cannot extend beyond property line. (4) Driveway radius cannot extend into public street on other driveway curb radius.				

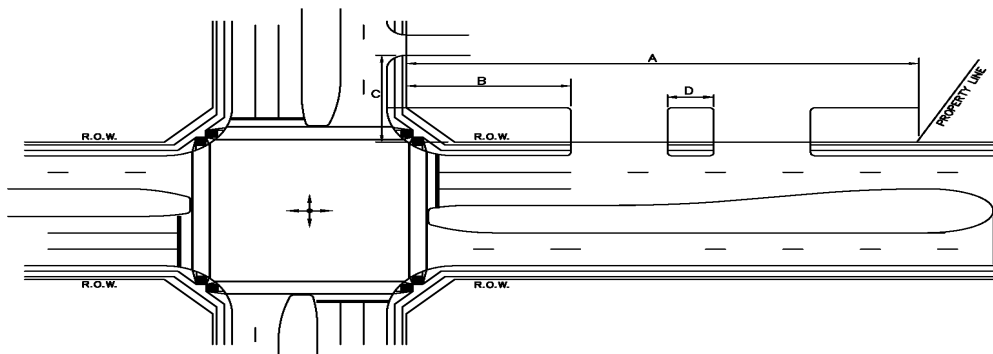

FIGURE 15.08.03
 DRIVEWAY PLACEMENT

Table 15.08.03 Non-Residential Driveway Placement Criteria (1)

A Frontage (2)	Number of Driveways	B Minimum Driveway Offset (Primary Street)	C Minimum Driveway Offset (Intersecting Street)	D Minimum Driveway Spacing
Up to 170 feet	1	100 feet	60 feet	20 feet
170 to 250 feet	2	100 feet	60 feet	20 feet
250 to 450 feet	3	100 feet	60 feet	20 feet
> 450 feet	1 additional / 250' frontage	100 feet	60 feet	20 feet

- (1) Applicable to driveways designed for commercial traffic (auto, truck, and bus access).
- (2) Where the development frontage is equal to or greater than the distance to first median opening, at least one driveway will be aligned with the existing and/or future location of the median opening.
- (3) For CBD or Locations unable to comply, approval of the City Engineer required.
- (4) All proposed access connections must be placed to achieve adequate intersection sight distance for safe and efficient departure from the proposed access connection (comply with AASHTO standard).
- (5) The minimum driveway offset for all major thoroughfare shall be 100 feet.
- (6) Driveway radius cannot extend beyond property line.
- (7) Driveway radius cannot extend into public street or other driveway curb radius.

- b. Notes regarding connection spacing:
 - (1) A pair of one-way driveways (entry and exit) should be considered as a two-way driveway for driveway spacing purposes.
 - (2) Spacing between one-way driveways requires the entry precedes the exit in the direction off the adjacent travel lane and the one-way pair meets spacing requirements from adjacent driveways or streets.
 - (3) For the special situation of multiple entry driveways placed on one-way street and exit driveways placed on a different street, two same street driveways should be considered as a one-way pair.
 - (4) Driveways on a street without a median should align with driveways on the opposite side of the street.
 - (5) Driveways shall not be placed in the intersection limits (see 15.03.I for definition of intersection limits).
 - (6) Driveway should be placed of a minimum offset distance of 75 ft from the median nose.

4. Medians

- a. Median design involves mainly median type, opening, and length. Installing medians provides the potential for safer street operation, increased capacity, and improved aesthetics.
- b. Median Openings
Median openings allow vehicles to cross opposing traffic lanes at designated locations. Requirements for median openings can be found in Chapter 10.08 of this manual.
- c. Minimum Median Lengths
The minimum lengths of medians between openings are determined by the functional classification of the street and the type of interruption (thoroughfare, collector, local street, private driveway, etc.) of the adjacent openings. Requirements can be found in Chapter 10.08 of this Manual.

5. Treatments for Turning Movements

- a. Turn lanes provide a refuge area for left and right turning vehicles. Turn lanes may be placed at intersection approaches, driveway approaches, and median openings to remove turning vehicles from the through lanes, thus reducing congestion and improving traffic operations, capacity, and safety.
- b. Dedicated Left-Turn Lanes
 - (1) Left-turn lanes shall be considered in the following situations:

- (a) All signalized intersection approaches along planned or existing streets having a classification of collector or higher;
 - (b) All unsignalized intersections and driveways along divided streets having a classification of collector or higher;
 - (c) All unsignalized intersections and driveways along undivided streets having a classification of thoroughfare or higher;
 - (d) All developments in excess of five acres located within 500 feet of the intersection of two or more thoroughfare facilities;
 - (e) New public or private school construction;
 - (f) Shopping centers and other traffic generators with a lease space in excess of one hundred thousand square feet;
 - (g) Places of worship.
- (2) The use of dedicated left-turn lanes should also always be guided by a traffic study. The use of a left-turn lane requires approval from the City Engineer.

c. Dedicated Right-Turn Lanes

The use of dedicated right-turn lanes should always be guided by a traffic study.

6. Minimum Turning Treatment Storage Length

- a. Storage length, as shown in Figure 15.08.04, is an important design element that ensures the provision of sufficient turn lane storage capacity to reduce instances of spillback. Left- and right-turn lane storage lengths must not be less than the minimum requirements outlined in Chapter 10.06 of this Manual.

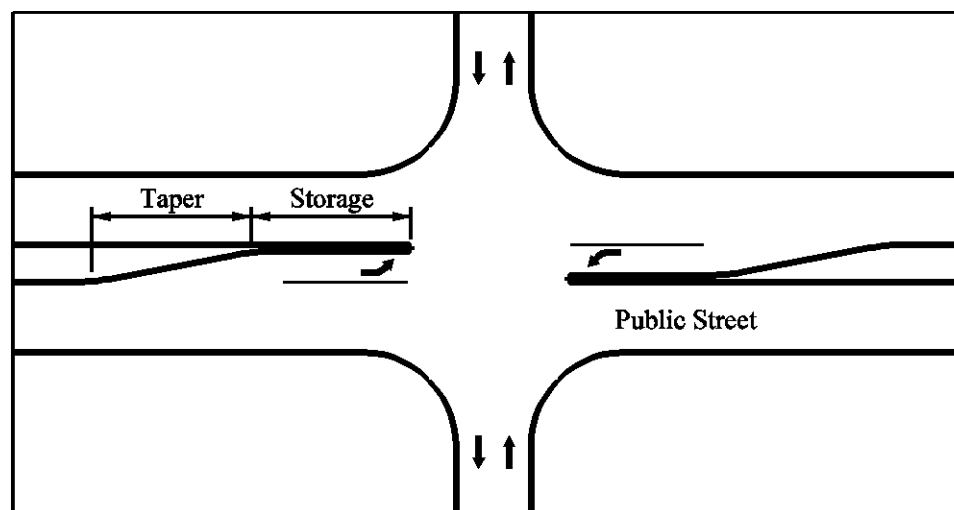

Figure 15.08.04 Turn Lane Details

b. Calculating Required Storage Length (Single Lane)

The required storage length for both left- and right-turn lanes can be obtained using traffic modeling software such as the latest version of the HCM Software (HCS) or Synchro/SimTraffic. The 95th percentile queue length is a widely accepted value for storage length. The following methods may be used to determine storage length.

Signalized Storage Length

For signalized intersections, the storage length should be determined based on results from computer analysis software.

Unsignalized Storage Length

Equation 1 is used to calculate unsignalized storage length.

$$L=(V/30)(2)(S) \quad \text{(Equation 1)}$$

Where:

L = storage length in feet

$V/30$ = turning volume in a two-minute interval

2 = a factor that provides for storage of all left-turning vehicles on most cycles

S = queue storage length, in feet per vehicle

15.09 TRAFFIC SIGNS

15.09.01 GENERAL

- A. This section of the Design Manual contains the criteria and formats to be used in designing and preparing plans for the installation and refurbishing of traffic signs in the City of Houston. The intent is to establish standard procedures and requirements that will be used by engineering designers and consultants when designing signing for City of Houston projects. All design shall also be in accordance with the Standard Highway Sign Designs (SHSD) for Texas and with the Texas Manual of Uniform Traffic Control Devices (TMUTCD).
- B. This document provides Designers and Consultants with:
1. the design requirements and guidelines for ensuring uniformity in sign types, mounting, size, and placement; and
 2. the required format of plan sheets to allow ease of review, minimization of construction errors, and facilitation of maintenance.

15.09.02 DESIGN REQUIREMENTS

- A. Description of Design/Review Process

3. Project Initiation
 - a. Determine Requirements of Other Agencies.
If the project falls under TxDOT's jurisdiction, verify TxDOT's signing requirements and if discrepancies exist between the City's requirements and TxDOT's, the Consultant shall meet with the City Traffic Engineer to reconcile any differences.
 - b. The Consultant shall meet with the City of Houston prior to beginning the signing design to discuss the project in detail. At this meeting, typical and any specialty signing within the project limits will be discussed. The meeting regarding traffic signing will generally occur as part of other project initiation meetings and will not require a separate meeting.
4. Collect Engineering Data
 - a. Collect all data required to develop a base map of existing conditions which can be used for the design process. Typically, traffic signing design will be included as part of a roadway, intersection, or traffic signal design project, and base maps for traffic signing design can be generated from the topographic survey and/or other design sheets.
 - b. The Consultant shall visit the project site to inventory and identify physical features that may impact traffic signing designs.
 - c. The Consultant shall perform an inventory of existing signing. The inventory shall include but is not limited to the following:
 - (1) Sign size, sign material, and general condition of the sign
 - (2) Sign type and legend
 - (3) Posted speed limit(s)
 - (4) Any specialty signs
 - (5) Sign post and foundation type
 - (6) Identify signs that will need to be relocated or replaced.
 - (7) Any obstructions or geometric features that may interfere with the installation or visibility of signs.
5. Develop Base Map of Existing Conditions
 - a. The Consultant shall develop a base map showing all the applicable data collected. The base map or drawing will be used to show the traffic signing design.
 - b. The base map shall include but is not limited to the following information:
 - (1) All roadway curb and gutter or edges of pavement

- (2) Roadway stations and centerline
 - (3) Right-of-way, easements and street names
 - (4) Driveways and intersections
 - (5) Sidewalks
 - (6) Other features deemed pertinent
6. Plans and Drawings
- a. General
 - (1) All traffic signing design shall be prepared on design sheet size required by the Project Manager, using the Standard City of Houston, Department of Public Works and Engineering Title Block. On the Traffic signing plans; proposed pavement markings shall be shown as a background information without callouts. Refer to Section 15.10, Pavement Markings, for details regarding the design of pavement markings.
 - (2) All full size designs shall be prepared at a scale of 1 inch equals 40 feet. If other design scales are needed, approval from the City Project Manager is needed before beginning design.
 - (3) All construction drawings shall be prepared in accordance with Chapter 3, Graphic Requirements.
 - (4) On projects where the Consultant finds it necessary to deviate from the standard format presented herein, due to project scope or design requirements, the City's Project Manager should be consulted to determine an acceptable alternate format. Any changes to the format are at the discretion of the City's project manager.
 - b. General Notes.

General Notes shown on City of Houston Standard Drawing 01509-01 should appear on all traffic sign design sheets. Additional notes may be added by the Consultant as may be necessary to properly clarify the intent of the design. The general notes in short include but not limited to the following items.

 - (1) Prior to start of construction, all existing signs within the area of construction shall be inventoried and documented jointly by the City Inspector and the Contractor. This document will be jointly signed by both parties reflecting the sign type, sign size, sign condition, sign location, reflectivity adequacy, etc. The Contractor is held accountable for these signs throughout the Project and at the Project's completion.

- (2) The Contractor will be responsible for safeguarding existing signs so that they either continue to remain visible and upright in the field or they are collected and stored in a secure area when temporary signs are used in lieu of the existing signs.
- (3) The Contractor will be responsible for re-installing existing signs that have been removed and stored by the Contractor if required per construction plans. The Contractor will provide and install signs that were documented missing prior to the start of work.
- (4) The Contractor shall replace any signs that are lost or damaged during construction. All signs shall meet City standards.
- (5) The Contractor shall install all permanent signs, posts and hardware as shown on the plans.

c. Ground Mounted Signs

- (1) All ground mounted signs, unless noted otherwise, shall be mounted at a height of 7 feet measured from the bottom of the sign to the top of curb or top of roadway at edge of pavement and shall be a minimum of 24 inches from the edge of pavement or curb.
- (2) All ground mounted signs shall use perforated square metal tubing 1-3/4" by 1-3/4". Special permission from the City Traffic Engineer will be required to use any other metal sign post.
- (3) Refer to City of Houston Standard Drawing 01509-01 (General Notes and Ground Sign Mounting) for additional details.

d. Street Name Signs

- (1) Street name signs shall include block numbers per the Standard Details.
- (2) Street name signs shall have a height of 9 inches. The length shall be 30 inches minimum and 48 inches maximum (in 1-inch increments). Sign plates longer than 48 inches must be approved by the City Traffic Engineer.
- (3) Refer to City of Houston Standard Drawing 01509-02 (Street Name Sign and Sign Mounting) for additional details related to ground mounted street name signs. Refer to Chapter 15, Section 15.11

(Traffic Signals) of this Manual for overhead mounted street name signs.

e. Ground Mounted Sign Sizes

- (1) All “STOP” and “YIELD” signs installed in the City of Houston shall be a minimum of 36 inches. Special approval is required from the City Traffic Engineer for “STOP” and “YIELD” signs less than 36 inches.
- (2) Refer to City of Houston Standard Drawing 01509-03 (Ground Mounted Sign Sizes) for dimensions of typically used sign plates and dimension of attachment holes.

f. Sign Placement

- (1) The placement of all signs shall be in conformance with the latest edition of the Texas Manual of Uniform Traffic Control Devices (TMUTCD).
- (2) Refer to City of Houston Standard Drawing 01509-04 (Sign Placement) for typical sign placement details and street name signs at typical intersections.
- (3) Refer to Traffic Signal Details for additional information regarding typical placement and location for signs mounted on mast arms.

g. City of Houston Approved Signs

- (1) City of Houston Standard Drawing 01509-05 and 01509-06 provide lists of Regulatory, Warning, Construction Work, Bicycle, and School signs with corresponding sign nomenclature, and dimension.
- (2) The designer shall use the signs listed on City of Houston Standard Drawing 01509-05 and 01509-06. Special permission from the City Traffic Engineer will be required to adjust the sign dimensions and/or use additional signs approved by TMUTCD. Note that this does not apply to special signs and guide signs specifically tailored for a specific location.

h. Sign Summary Sheet

The Consultant shall include a sign summary sheet as part of the signing design. The format of the Sign Summary Sheet is shown by City of Houston Standard Drawing 01509-07 (Summary of Signs). The sign summary table shall include the following information: plan sheet number, sign number, sign nomenclature, sign text, dimensions, post type, number of posts, sign area (square footage only for special signs), and sign post size.

15.10 TRAFFIC PAVEMENT MARKINGS

15.10.01 GENERAL

- A. This section of the Design Manual contains the criteria and formats to be used in designing and preparing plans for the installation of pavement markings in the City of Houston. The intent is to establish standard procedures and requirements that will be used by engineering designers and consultants when designing pavement markings for City of Houston projects. All design shall also be in accordance with the Texas Manual of Uniform Traffic Control Devices (TMUTCD).
- B. This document provides Designers and Consultants with:
1. the design requirements and guidelines for ensuring uniformity in pavement marking materials, arrangement, and details; and
 2. the required format of plan sheets to allow ease of review, minimization of construction errors, and facilitation of maintenance.

15.10.02 DESIGN REQUIREMENTS

- A. Description of Design/Review Process
1. Project Initiation
 - a. Determine Requirements of Other Agencies. If the project falls under TxDOT's jurisdiction, verify TxDOT's pavement marking requirements and if discrepancies exist between the City's requirements and TxDOT's, the Consultant shall meet with the City Traffic Engineer to reconcile any differences.
 - b. The Consultant shall meet with the City of Houston prior to beginning the pavement marking design to discuss the project in detail. At this meeting, typical and any specialty pavement markings within the project limits will be

discussed. The meeting regarding pavement marking generally occurs as part of other project initiation meetings and will not require a separate meeting.

2. Collect Engineering Data

- a. Collect all data required to develop a base map of existing conditions which can be used for the design process. Typically, pavement marking design will be included as part of a roadway, intersection, or traffic signal design project and base maps for traffic pavement marking design can be generated from the topographic survey and/or other design sheets.
- b. The Consultant shall visit the project site to inventory and identify physical features that may impact pavement marking design.
- c. The Consultant shall perform an inventory of existing pavement markings. The inventory shall include but is not limited to the following:
 - (1) Lane width, pavement marking material, and general condition of the markings
 - (2) Posted speed limit(s)
 - (3) Any special pavement markings such as rail crossings, school zone, etc., and
 - (5) Existing lane configurations and lane assignments.

3. Develop Base Map of Existing Conditions

- a. The Consultant shall develop a base map showing all the applicable data collected. The base map or drawing will be used to show the pavement marking design.
- b. The base map shall include but is not limited to the following information:
 - (1) All roadway curb and gutter or edges of pavement
 - (2) Roadway stations and centerline
 - (3) Right-of-way
 - (4) Driveways and intersections
 - (5) Sidewalks
 - (6) Other features deemed pertinent

4. Plans and Drawings

a. General

- (1) All pavement markings design shall be prepared on design sheet size required by the Project Manager, using the Standard City of Houston, Department of Public Works and Engineering Title Block. Traffic

signing and pavement markings shall be shown on different plan sheets. Refer to Section 15.09, Traffic Signs, for details regarding the design of traffic signs.

- (2) All full size designs shall be prepared at a scale of 1 inch equals 40 feet excluding notes and detail sheets. If other design scales are needed, approval from the City Project Manager is needed before beginning design.
- (3) All construction drawings shall be prepared in accordance with Chapter 3, Graphic Requirements.
- (4) On projects where the Consultant finds it necessary to deviate from the standard format presented herein, due to project scope or design requirements, the City's Project Manager should be consulted to determine an acceptable alternate format. Any changes to the format are at the discretion of the City's project manager.
- (5) Limits of the project (beginning and ending stations) are to be provided including centerlines and stationing at 100-foot intervals.
- (6) All changes to pavement marking lines and symbols shall be labeled by station call-outs to the nearest whole number (##+##).
- (7) Existing pavement markings to remain and proposed items such as ROW lines, edge of pavement, and curbs shall be delineated at lighter weight/shade than proposed pavement markings on pavement marking design sheets.
- (8) At a minimum, lane widths between lane markings and face of curb/edge of pavements shall be provided every 500 feet using the center of the pavement markings as a reference point.
- (9) General notes and quantities of pavement markings and sheet shall be prepared for every design project. In addition, line style designation methodology shown on City of Houston Standard Drawing 01510-01 shall be used to call out pavement marking line types on all design sheets.

b. General Notes.

General Notes shown in City of Houston Standard Drawing 01510-01 should appear on all pavement marking design sheets. Additional notes may be added by the Designer as may be necessary to properly clarify the intent of the design.

- (1) With the general notes a table showing bid items and quantities shall be provided.
 - (2) Every type of pavement marking line width, pattern, and width combination shall be assigned specific bid item with quantity in linear feet (LF). For example, lane lines (WB4) will have total LF quantity and unique bid item number.
 - (3) Every symbol and text type shall be assigned a bid item with quantity as Each (EA). For example, white single arrow will have total count quantity and unique bid item number.
 - (4) Every type of Raised Pavement Marker (RPM) shall be assigned a bid item with quantity as Each (EA). For example, Type I-C "C" RRPM will have total count quantity and unique bid item number.
- c. Left/Right-Turn "Only" and Arrow Spacing (Refer to City of Houston Standard Drawing 01510-02)
 - d. Pavement Marking Words (Refer to City of Houston Standard Drawing 01510-03)
 - e. Pavement Marking Symbols and Arrows (Refer to City of Houston Standard Drawing 01510-04)
 - f. Standard Pavement Markings with Reflective raised Pavement Markers for Position Guidance (Refer to City of Houston Standard Drawing 01510-05)
 - g. Use of Reflective Chip Seal Marker for Temporary Markings (Refer to City of Houston Standard Drawing 01510-06)
 - (1) On some long term temporary pavement markings plan, the designer may select use of raised pavement marker buttons instead of chip seal marker. In such cases the designer has to provide special temporary pavement marking RPM button arrangements for each line type and use of reflective raised pavement markers.
 - h. Pavement Marking for Accessible Parking (Refer to City of Houston Standard Drawing 01510-07)

- (1) Please note that angled parking on public streets require City Council approval before implementation per City of Houston Code of Ordinances.
- i. Railroad Crossing Pavement Markings (Refer to City of Houston Standard Drawing 01510-08)
- j. Bicycle Facilities Pavement Markings (Refer to City of Houston Standard Drawing 01510-09)
- k. Crosswalks Pavement Markings (Refer to City of Houston Standard Drawing 01510-10)
 - (1) High visibility crosswalks should only be used where documented need is identified such as designated school crossings.
- l. Right- and Left-Turn Lanes (Refer to City of Houston Standard Drawings 01510-11 and 01510-12)
- m. Two-Way Left-Turn Lanes (Refer to City of Houston Standard Drawings 01510-13 and 01510-14)

15.11 TRAFFIC SIGNALS

15.11.01 GENERAL

- A. This document presents the criteria and formats to be used in designing improvements and preparing plans for traffic signal work in the City of Houston. It will also outline general requirements and guidelines to be followed by the designers of traffic signals for the City of Houston. This section is not intended to replace sound engineering judgment or the standards of engineering practice. The designer shall also follow the guidelines published in the Texas Manual on Uniform Traffic Control Devices and in documents from the Institute of Transportation Engineers.
- B. These design guidelines are applicable to both new traffic signal construction and to the modification of existing traffic signals. If any portion of a traffic signal installation is being modified, the City requires the entire signal be upgraded to current standards. Permission to deviate from these standards must be received prior to submission on construction drawings for review and approval.
- C. The document provides consultants with:

1. the analysis requirements for determining what improvements should be recommended,
2. the design requirements and guidelines for ensuring uniformity in type and location of equipment, operational features, and intersection layout; and
3. the required format of plans and contract documents to allow ease of review, minimization of construction errors, and facilitation of maintenance.

15.11.02 DESIGN REQUIREMENTS

A. Description of Design/ Review Process

1. Solicit Information From Other Agencies
 - a. Determine Requirements of Other Agencies & Property Owners. Verify with TxDOT their requirements if the intersection or street approaches fall under their jurisdiction. If discrepancies exist between the City's requirements and TxDOT's, the Consultant shall meet with the City Traffic Engineer to reconcile any differences. If access to private property (residential, industrial, or commercial, etc.) is involved, the Consultant shall contact the property owner involved, determine how the access will be affected, and coordinate with the City any differences which may exist.
 - b. Contact Appropriate Electrical Utility for Power Hook-up and Illumination Requirements. The Consultant shall verify with the electric utility involved in the project the power hook-up requirements. The Consultant shall work with the Utility to determine the service location during design and this location shall be indicated on the plans. The Consultant shall note who is responsible for each component of a service hook-up, including the conduit and cable run from the load center to the power source, the conduit riser on the power pole and the actual splice into the power system. The responsibilities shall be clearly stated in the project plans.
 - c. Contact the Railroads and Verify Their Requirements Regarding Traffic Signal Pre-emption or Crossing of Tracks with Conduit Runs. If railroad pre-emption is required because of proximity to an intersection, contact should be made with the railroad's manager of telecommunications and signals early in the design process to determine their needs or requirements. If railroad right-of-way must be crossed with conduit runs, the Consultant shall determine the railroad's requirements for conduit type, size, depth, construction methods and restrictions.
2. Collect Engineering Data.

- a. Collect all data required to develop a base map of existing conditions which can be used for the design process and operational evaluation.
- b. Topographic Features
On each approach where advance detection or street improvements are anticipated, detailed information on topographic features should be collected for the area within 500 feet of the intersection. Otherwise, the topographic information is only required for the distance anticipated for the detection zone setbacks and for poles, traffic signal controllers, and related underground conduits.
 - (1) Widths and alignments of streets, lanes, and shoulders.
 - (2) Median widths and lengths.
 - (3) Curve radii.
 - (4) Tapers.
 - (5) Turn lanes.
 - (6) Driveways & sidewalks.
 - (7) Pavement type.
 - (8) Existing pavement markings and raised channelization.
 - (9) Grades.
 - (10) Sight distance obstructions.
 - (11) Parking conditions.
 - (12) Right-of-way lines and easements.
 - (13) Building lines.
 - (14) Angle of intersecting streets.
 - (15) Trees and shrubs.
 - (16) Railings and barriers.
 - (17) Handicapped curb ramps.
 - (18) Street furniture.
 - (19) Drainage features.
 - (20) Traffic signal equipment:
 - (a) Pole locations.
 - (b) Signal head locations and types.
 - (c) Controller cabinet location.
 - (d) Pull boxes (location and size), and conduits.
 - (e) Loop Detector locations.
 - (f) Service location (existing and potential).
 - (g) Existing signal interconnect cable and/or conduit.
 - (21) Existing illumination (location and type).
 - (22) Existing signs.
 - (23) Existing pavement markings
 - (24) Overhead utilities (horizontal and vertical clearances).
 - (25) Underground utilities.

Special attention should be given to obtaining a precise location of utilities. The designer shall request utility information from all utilities within the survey area. Field location should be requested for all utilities including traffic signal cables, conduits and detectors. Accurate horizontal and vertical clearance information shall be obtained for overhead utility lines including the sag of the cables between supports.

- c. Operational Data (If the Location has an Existing Traffic Signal):
 - (1) Phasing and timings.
 - (2) Signal displays.
 - (3) Type of controller and cabinet.
 - (4) Detection methodology.
 - (5) Traffic Signal Communications System Features.

- d. Traffic Data (If Required by the City):
 - (1) Counts and projected volumes (24-hour approach and turning movements in am, pm, and noon peaks).
 - (2) Speed limit and speed study.
 - (3) Accident history and diagrams (if available).
 - (4) Pedestrian volume and patterns.

- e. Miscellaneous Data:
 - (1) Bus stops and routes.
 - (2) Adjacent land uses.
 - (3) Proximity of railroad crossings.
 - (4) Proximity of emergency vehicle sources.
 - (5) Other construction in progress in the area.
 - (6) Adjacent street and drainage structures.

It may be possible to obtain information on existing topographic features from existing plans or maps. This data may be used for reference, but all plan preparation shall be based on field survey unless pre-approved by the City. Operational data and traffic data may be available from the City but may need to be supplemented by studies conducted by the Consultant.

- 3. Develop Base Map of Existing Conditions.
 - a. The Consultant shall develop a base map showing all the applicable data collected. This map will be used as a base for showing all phases of the traffic signal design work and all geometric design work.

 - b. Directional Orientation.
All plan sheets shall have the intersection oriented with North to the top of the sheet or to the left of the sheet (if required to provide significantly better utilization of space).

 - c. Scale.

Traffic signal plans should be drawn a 1" = 20' scale at full size. Break lines may be used to show advanced detection of other features away for the intersection. Blown up details at a larger scale may be used as necessary to show areas with numerous conflicts or many items to be shown in a compact area.

d. Existing Conditions.

The traffic signal base maps shall be printed using CSI Standards resulting in a lighter tone for existing conditions. The plan shall include, but not be limited to, the following information:

- (1) Right-of-way, easements and street names.
- (2) Curbs and medians.
- (3) Lane lines and channelization.
- (4) Sidewalks.
- (5) Utilities (underground and overhead):
 - (a) Electric.
 - (b) Gas.
 - (c) Telephone.
 - (d) Communications & Cable TV.
 - (e) Traffic and Illumination
 - (f) Sanitary Sewer.
 - (g) Storm Sewer.
 - (h) Water.
 - (i) Utility manholes, vaults and valves.
- (6) Monuments and benchmarks.
- (7) Driveways.
- (8) Signs and poles.
- (9) Angle of intersecting streets.
- (10) Building lines.
- (11) Other pertinent features (e.g., trees, shrubs, street furniture, etc.).

4. Plans and Drawings.

a. General.

- (1) All plans and drawings should be prepared with black ink on Consultant furnished 22-inch x 34-inch Mylar reproducible sheets, using the Standard City of Houston, Traffic and Transportation Division Title Block on all traffic sheets.
- (2) Standard Title Sheet, General Notes and Responsibilities Sheet, Traffic Signal Plan Sheet(s), Pole Schedule and Cable Schematic Sheet, and Detail Sheets, should be used for all traffic signal projects. An electronic Title Sheet, General Notes and Responsibilities Sheet and blank Pole Schedule are available from the City for use on traffic

signal projects. Plan sets should not include copies of the City’s standard traffic signal details.

- (3) If necessary, additional sheets for plans and profiles, pavement markings or signing shall be provided as needed or as directed.
- (4) A legend will be provided showing any non-standard symbols.
- (5) On projects where the Consultant finds it necessary to deviate from the standard format presented herein, due to project scope or design requirements, the City’s Project Manager should be consulted to determine an acceptable alternate format. Any changes to the format are at the discretion of the City’s project manager.
- (6) Graphic requirements for engineering drawings shall comply with Chapter 3, Graphic Requirements. New lane striping shall be shown using CSI/NCS pen format.

b. Plan sets should consist of the elements listed below:

- (1) Title Sheet (City Standard).
- (2) General Notes and Responsibilities Sheet.
- (3) Traffic Signal Plan Sheet(s).
- (4) Pole Schedule and Cable Schematic Sheet(s).
- (5) Detail Sheet(s) (as required).
- (6) Plan and Profile Sheets (as required).
- (7) Pavement Marking Sheet(s) (as required).
- (8) Signing Plan Sheet(s) (as required)
- (9) 11-inch by 17-inch plan sheet showing locations of curb lines, sidewalks/ramps, signals and signal cabinets with WB-50 turn movements superimposed over the intersection. This sheet is information to be submitted with plan sets for review but is not required as mylar sheet in final plan set.

City of Houston Standard Traffic Drawings shall **NOT** be included as a part of the plan set.

c. Provide a table for inductive loop applications to show the station and offset for detection loops and stop lines on the plan sheet. A sample table is shown below.

STOP LINE AND LOOP DETECTOR LOCATIONS

ITEM BY APPROACH	STREET 1 STATION OF APPROACH EDGE	OFFSET FROM CONST CL TO CL OF LOOP	ITEM BY APPROACH	STREET 2 STATION OF APPROACH EDGE	OFFSET FROM CONST CL TO CL OF LOOP
EASTBOUND: STOP LINE:	STA. XX+XX		SOUTHBOUND: STOP LINE:	STA. XX+XX	
PHASE 2 PULSE LOOP	STA. XX+XX	CENTERED IN LANE	PHASE 4 PULSE LOOP	STA. XX+XX	CENTERED IN LANE
PHASE 5 PRESENCE LOOP	STA. XX+XX	CENTERED IN LANE			

WESTBOUND: STOP LINE:	STA. XX+XX		NORTHBOUND: STOP LINE:	STA. XX+XX	
PHASE 6 PULSE LOOP	STA. XX+XX	CENTERED IN LANE	PHASE 8 PULSE LOOP	STA. XX+XX	CENTERED IN LANE

d. Pole Schedule and Cable Schematic Sheet.

(1) Pole Schedule.

A pole schedule shall be provided showing the pole and its identifier, the pole type, information on the mast arm(s), signal heads, luminaire, pedestrian pushbuttons and signs, the pole location and relative City standards. Each pole will have its own row within the schedule. The pole schedule shall be a table formatted as shown below.

POLE NUMBER	POLE TYPE	MAST ARM		SIGNALS		LUMINAIRE TYPE	PED PB TYPE/SIGN	REMARKS	LOCATION	STANDARDS
		SIGNAL	LUMINAIRE	MOUNTING	FACE					

(2) Cable Schematic.

Low and high-voltage cable schematics shall be displayed on the pole schedule and cable schematic sheet. The cable schematic shall include:

- (a) Conduit Run Identifiers.
- (b) Conduit Size.
- (c) Type of Conductors in each run.
- (d) Legend.
- (e) Consultant shall conduct interim review of project status and technical issues with city at appropriate project milestones agreed upon by City and consultant.

5. Field Books.

- a. Typically, field books will be prepared by the City. A designer should not submit a field book unless specifically requested by the City. All timing data requested by the City shall be submitted electronically in a format specified by the City.
- b. If requested, field books should contain the following:
 - (1) 2070 Programming/Timing Sheets.
 - (2) CMU Programming Sheets.
 - (3) Signal Layout.
 - (4) Cabinet Drawings.
 - (5) Field Input Panel Sheet.
 - (6) Field Output Panel Sheet.

B. Intersection Design Study.

The purpose of this operational analysis is to document the information, assumptions, and procedures used to develop the preliminary design and to affirm that the design level of service will be provided through the design year.

1. Conditions to be analyzed.

The Intersection Design Study shall present an analysis of the intersection traffic operation and level of service for the AM and PM peak hours for each of the following conditions:

- a. Existing traffic and geometric conditions.
- b. Projected traffic and proposed geometric conditions in the design year with the traffic signal(s) in operations.
- c. Projected traffic and proposed geometric conditions at project completion, including projections of any new traffic due to trip diversions and/or known new trip generation with traffic signals in operation.
- d. Projected traffic and proposed geometric conditions in the intermediate year with traffic signals in operation.

2. Method of Analysis.

The level of service for the signalized conditions shall be determined in accordance with the procedures defined in the current edition of the Highway Capacity Manual (HCM). An approved software (Highway Capacity Software (HCS), Synchro or VisSim) will be used, and the printouts from that software will be part of the study. Other software packages may be acceptable, but their use will require prior approval by the City. The Highway Capacity Manual is available from the Transportation Research Board and the software is generally available from McTrans and other sources. When the Consultant proposes a less conservative design than determined by HCM method, Consultant will be required to provide supporting evidence to the satisfaction of the City. If the City requests additional analysis to evaluate new/alternative technology and such work causes additional work, Consultant shall obtain written authorization from the City prior to initiating work.

3. Required Level of Service:

The level of service to be provided in the design year shall be level of service D or better (i.e.; LOS A, B, or C).

4. Application Method.

The Operational method shall be used for all analysis.

5. Procedure.

The Consultant shall determine the geometrics required to provide the design level of service in the design year. After determining the required geometrics, the Consultant shall analyze the intersection for the proposed geometrics and projected traffic upon project completion using the methodology for unsignalized intersections. If these conditions result in a level of service “B” or better for all movements, additional analysis may be required, but will be considered extra work.

6. Traffic Signal Warrant Analysis.

- a. The engineer shall obtain a previously completed traffic signal warrant analysis or perform a new traffic signal warrant analysis for the intersection.
- b. When conducting a new warrant analysis, the engineer shall focus on that the subject intersection meets “strong” warrants. The City defines Warrants 1 – Eight-Hour Vehicular Volume and Warrant 7 – Crash Experience. In the case where weaker warrants are met, all other measures must be exhausted before a recommendation for a traffic signal will be approved by the City.
- c. The engineer should note that not all warrants are applicable to all intersections.
- d. The engineer shall also avoid mid-block locations for new signals. New signals should be spaced at least $\frac{1}{4}$ mile away from existing or planned signals.
- e. The City requires that a minimum of eight (8) hours (includes am and pm peak hours) of turning movement counts be collected for a traffic signal warrant analysis. If a right turn lane is available or is recommended, all right turning traffic shall be deducted from the hourly approach volumes. If a shared through/right turn lane exists, one half of all right turning traffic on the approach shall be deducted. This is based on the presumption that right turning vehicles typically do not require a traffic signal in order to safely enter another street.
- f. When conducting a traffic signal warrant analysis, engineering judgment is required to determine whether the left turn lane is counted as an additional lane. As a rule of thumb, the engineer should consider the ratio of left turning traffic to the other traffic. If the left turning volume exceeds twenty (20) percent of the total traffic, the left turn lane should be counted as an additional lane. Exclusive right turn lanes are not to be counted as an additional lane since their volumes are be deducted from the totals.

7. Hybrid Pedestrian Signals

- a. Hybrid Pedestrian Signals or High Intensity Activated Crosswalks (HAWK) studies shall follow the same basic procedures as those for a standard traffic signal warrant analysis except they shall use the warranting conditions set forth in Section 4F.01 of the Texas Manual on Uniform Traffic Control Devices.
 - b. HAWK signals are intended for use at mid-block crossings and should not be proposed for installation at intersection crosswalks without discussing with the City Traffic Engineer.
8. Left Turn Phasing Analysis.
- a. Purpose. These guidelines provide a method to uniformly evaluate and install appropriate left turn phasing at traffic signals within the City of Houston. These guidelines attempt to minimize the restrictions placed on motorists' ability to turn safely through gaps in opposing traffic when such turns can be performed safely.
 - b. Procedure. Information should be obtained by means of engineering studies and compared with these guidelines. Rigid adherence to these guidelines is not a replacement for good engineering judgment.
 - c. General Guidelines and Considerations.
 - (1) Traffic engineering judgment must be used to determine left turn phasing recommendations. Final engineering recommendations, based on engineering judgment may supersede any or all guidelines.
 - (2) The least restrictive form of left turn phasing, that can operate safely, should be considered for implementation. More restrictive control can be made as traffic conditions change.
 - (3) Proper "yellow trap" protection phasing is required when protected-permitted phasing is used in a lead-lag configuration.
 - (4) Permitted left turn phasing is primarily suited for intersections where opposing and left turn volumes are low and left turns are able to turn through gaps in traffic without great difficulty or excessive delay.
 - (5) Protected-permitted phasing is appropriate when the left turn need is based predominately on volume and delay and the signal is at a moderately traveled intersection where frequent gaps for left turns occur.
 - (6) Protected-only left turn phasing should be used when left turn phasing is required primarily for safety reasons based on left turn crash experience or site conditions, or when the opposing number of lanes is three or more.
 - d. Permitted Left Turn Phasing. Permitted left turn phasing may be installed based on the following guidelines:

- (1) Traffic Volumes. This guideline is based on minimum peak hour left turn volume and the product of the peak hour left turn and opposing volumes (LT X OV) and the number of opposing lanes (NL). Permitted phasing may be appropriate if:
 - (a) Peak hour left turn volume is less than 2 vehicles per cycle.
 - (b) Peak hour (LT X OV)/NL is below 50,000.
 - (2) Site Conditions. This guideline is based on several existing conditions at the intersection location. Permitted phasing may be appropriate if :
 - (a) Available sight distance is greater than 350 feet when the opposing traffic is traveling at 35 mph or less, or greater than 400 feet when the opposing traffic is traveling at 40 mph or more.
 - (b) Opposing speed is less than 45 mph.
 - (c) Double left turns are not in operation.
 - (d) Median width and the number of opposing lanes do not preclude safe permitted turn operations.
 - (3) Vehicle Delay. This guideline is based on peak hour left turn delay. Permitted phasing may be appropriate if :
 - (a) The mean peak hour delay per left turning vehicle is less than 50 seconds.
 - (b) The total peak hour left turn delay is less than 3.0 vehicle hours.
 - (4) Crash Experience. The installation of a more restrictive form of left turn control may be required if six (6) or more left turn crashes occurred in the past twelve (12) months.
- e. Protected – Permitted Left Turn Phasing. Protected-permitted left turn phasing provides the benefits of permitted left turn phasing while adding left turn capacity and can reduce delay to motorists. Protected-permitted phasing may be appropriate for the following conditions:
- (1) Traffic Volume. Protected-permitted phasing may be appropriate if:
 - (a) Peak hour left turn volume is greater than 2 vehicles per cycle.
 - (b) Product of the peak hour (LT X OV) is less than 400,000.
 - (c) Peak hour (LT X OV)/NL is between 50,000 and 200,000.
 - (2) Site Conditions. See guideline for permitted left turn signal phasing.
 - (3) Vehicle Delay. Protected-permitted phasing may be appropriate if:
 - (a) The mean peak hour delay per left turning vehicle exceeds 50 seconds.
 - (b) The total peak hour left turn delay exceeds 3.0 vehicle hours (per leg).
 - (4) Crash Experience. See guideline for permitted left turn phasing.
- f. Protected-Only Left Turn Phasing. Protected-only left turn phasing is the most restrictive form of left turn control. Protected-only left turn phasing may be appropriate under the following conditions.

- (1) Traffic Volume. Protected- only phasing may be appropriate if:
 - (a) Peak hour left turn volume is greater than 2 vehicles per cycle.
 - (b) Product of peak hour (LT X OV) is greater than 400,000.
 - (c) Peak hour (LT X OV)\NL is greater than 200,000.
 - (2) Site Conditions. Protected-only phasing may be appropriate if:
 - (a) Available sight distance is less than 350 feet when the opposing traffic is traveling at 35 mph or less, or less than 400 feet when the opposing traffic is traveling at 40 mph or more.
 - (b) Opposing speed is greater than, or equal to 45 mph.
 - (c) Double left turns are in operation.
 - (d) Median width and number of opposing lanes preclude safe permitted turn operations.
 - (3) Vehicle Delay. See guideline for protected-permitted left turn signal phasing.
 - (4) Crash Experience.
 - (a) Six (6) or more left turn crashes occurred in the most recent twelve (12) month period.
 - (5) Policy Compliance. All new left turn phasing installed within the City of Houston will be evaluated and installed using these guidelines and engineering judgment.
 - (6) Policy Exception. Exceptions shall be allowed, as deemed appropriate, by the Assistant Director managing the Traffic Operations Branch.
9. Alternative Lane Configurations.
- a. The level of service analysis shall be used to determine the required number of through lanes and auxiliary lanes (left and/or right turn lanes) needed to most economically provide the necessary level of service.
 - b. Left turn lanes greatly benefit the operation of an intersection which has enough traffic to require signals. As a result, all new traffic signal designs shall require the inclusion of a left turn lane unless otherwise specified by the City. In areas such as the Central Business District, where speeds are low and right-of-way is not available or is very expensive, the benefits of left turn lanes may be outweighed by the cost.
 - c. Right turn lanes and double left turn lanes should be considered as a means of achieving the desired level of service where the specific turning volumes are very high.
10. Alternative Phasing.

- a. Permitted Left Turns. Permitted only left turns (no separate signal phase displayed) shall be used unless more restrictive left turn phasing is required as described below.
- b. Protected/Permitted Left Turn Phasing. Protected/permitted left turn phases are required when any one of the following criteria is met:
 - (1) They are needed to achieve the required level of service.
 - (2) The left-turn demand meets the guidelines stated in the current “Left Turn Phasing Analysis” section of this document.
- c. Protected Left Turn Phases. Protected only left turn phases are required when the following criterion is met:

The left-turn demand meets the guidelines stated in the current “Left Turn Phasing Guidelines” section of this document.
- d. Split Phasing. Split phasing shall be defined as separating two opposing directions of traffic such that the compatible through and protected left turn movement receives the right-of-way simultaneously. Split phasing shall require the approval of the City prior to submitting the preliminary design plans. This phasing should only be used if one of the following conditions exists:
 - (1) The opposing approaches are offset to the extent that simultaneous left turns in opposing directions would cause a high number of conflicts, resulting in a high collision potential, and the left turn demand is sufficiently high to require as much green time as the adjacent through movement. When left turn volumes are lighter, and physical conflict exists, lead-lag operation should be used.
 - (2) Double left turn lanes are used in one or both directions and the turning radii are not sufficient to allow simultaneous left turns without conflicts between opposing left turn traffic, and subject to the same volume requirements in Item (a) above.
 - (3) The left turn volume is extremely heavy on an approach that does not allow the construction of a separate left turn lane.
 - (4) Left turn volumes are extremely heavy on opposing approaches and both are nearly equal to the adjacent through movement critical lane volume (A check should be made to determine that the design hour level of service will be significantly improved and that there will not be substantial decreases in level of service during other hours of the day).
 - (5) The critical lane volumes are lowest when drivers are permitted to turn left from more than one lane, and are also permitted to use the right-most left turn lane as a through lane.
 - (6) If the intersection is in an interconnected system and the coordination plan would be improved by splitting the phases.

- e. Right Turn Overlaps. Overlaps are encouraged where needed. Right-turn overlaps should be used only if there is a dedicated right turn lane on the approach and pedestrians are prohibited from crossing parallel and to the right of the concurrent through movement from the same approach. If right turn overlaps are provided, it will be necessary to prohibit u-turns for the opposing left turn approach. Appropriate signing should be detailed in the plans. An example of this operation would be when the left turn arrows on the main street approach are displayed simultaneously with a right turn arrow on one or both side street approaches. This type of operation should only be used where:
 - (1) there are 250 or more right turns during a peak hour and;
 - (2) there are 200 or more corresponding left turns during the same hour and;
 - (3) the per lane through volume for the same approach is approximately equal to, or less than, the right turn volume.

C. Geometric Design Elements.

If the construction of geometric changes in the street is required, the work shall be done in accordance with the City of Houston's Uniform Development Code, Chapter 10 of the Infrastructure Design Manual, and in accordance with the following criteria:

1. Design Speed.

The design speed for a street shall be the anticipated 85th percentile speed plus 5 MPH, in accordance with the major thoroughfare and Freeway Plan (MTFP), or as directed.

2. Design Vehicle.

The design vehicle shall be a WB-50 (AASHTO Green Book) or as directed.

3. Auxiliary Lane Design.

- a. Opposing left turn lanes shall be designed for protected/permitted left turn signalization unless protected only left turn phasing is required by Section 15.11.02.B.7. Sight distance for drivers of left turning vehicles to see beyond opposing left turning vehicles shall be calculated in accordance with Case III A – Crossing Maneuver (AASHTO Green Book).
- b. The storage length of the left or right turn lanes shall be determined based on the expected queue length as defined in Section 15.08 C.6. of the Infrastructure Design Manual. The minimum left turn lane storage length shall be 100 feet unless restricted by other factors. The maximum left-turn lane length should be 400 feet. If the expected queue storage length exceeds

400 feet or the left turning volume during the peak hour exceeds 200 vehicles, dual left turn lanes should be considered.

4. Tapers.
 - a. A taper, in this context, refers to the transition in pavement width between the centerline and the edge of pavement, e.g., the lateral transition of a median to accommodate a left turn bay. Wherever possible, the transition taper shall be a symmetrical reverse curve. This taper length shall not be subtracted from the total required storage length (Total Turn lane Length = Storage Length + Transition Taper length).
 - b. All approach taper ratios for collectors and thoroughfares shall be based on the posted speed limit plus 5 mph or 85th percentile speed (whichever is greater) and shall be calculated using the formulas described in the Texas Manual on Uniform Traffic Control Devices.
5. Islands.

Generally, raised (curbed) islands for the use of channelizing traffic, as in the case of a right turn lane, shall not be used. When islands are needed, sizes and dimensions should meet the recommended AASHTO requirements. Mountable curb and gutter shall be used on all islands.
6. Medians.
 - a. The minimum width of a raised median shall be four feet from face of curb to face of curb. A six-foot width shall be considered where a left turn lane is opposed by three or more right and through lanes to provide greater pedestrian storage and to reduce pedestrian clearance timings.
 - b. Both vehicle and pedestrian characteristics should be considered for design of the location of the median nose.
 - c. Bullet nose medians shall be required adjacent to a left turn bay at an intersection with a street other than a primary arterial. This 3-centered curve shall have radii of 50', 3', and 50'.
 - d. The median opening must be wide enough to provide for adequate turning movements by left turning vehicles. In no case shall the median opening be narrower than 40 ft.
 - e. In the development of a left or right turn lane; the pavement shall be widened via a symmetrical reverse curve as described in the Infrastructure Design Manual, Figure 10.06-07.
7. Pedestrian Access Ramps.

At intersection corners without sidewalks, where traffic signal poles are to be installed, a pedestrian landing shall be constructed according to the City of Houston Specifications and Standard Drawings. The ramp design should be directional and in most cases, two directional ramps per corner shall be required. Approval of the ramp design as part of intersection layout should not be construed as approval of the ramp designs for traffic signal designs.

8. Curb Return Radius.

Where two streets intersect, certain radii are required for the curbs per the Infrastructure Design Manual.

D. Pavement Markings.

Before traffic signals are located on the base map, the pavement markings (existing or proposed) should be located to act as a guide in the location of signal heads and detector loops. Pavement markings shall conform to the Standard Specifications and Detail Sheets as well as meet the following guidelines:

1. Pavement Marking Materials.

- a. Preformed plastic pavement markings, as specified in the Standard Specifications, shall be used for all lane lines, island markings, cross hatching, arrows and legends.
- b. Preformed plastic pavement markings, as specified in the Standard Specifications, shall be used for all pedestrian crosswalks and stop bars.

2. Lane Lines.

- a. Lane lines shall be aligned with corresponding lane lines on the opposite side of the intersection.
- b. Lane lines shall terminate at the stop or at the curb return (on uncontrolled approaches).

3. Crosswalks.

- a. Crosswalks shall be installed across all approaches except where pedestrians are prohibited from crossing. They shall provide access to all corners of an intersection.
- b. Crosswalks shall be ten feet wide. See the City of Houston Standard Detail for crosswalk configuration.

- c. Crosswalks should match up with handicapped ramps where possible.
 - d. No transverse marking shall be placed within 18" of the curb or raised median.
4. Stop Lines.
- a. Stop lines shall be placed at all signalized locations.
 - b. The stop lines shall be 24" wide and extend from a point 18" from the curb to the solid double yellow line (or a point 18" from the raised median). It shall be located in accordance with City Standards.
5. Turn Arrows and Legends.

City of Houston only uses Arrows or Onlys in exclusive turn lanes.

E. Traffic Signal Hardware Design.

The traffic signal hardware shall be designed in accordance with the following criteria:

1. Traffic Signal Heads.
- a. Number and Location of Heads:
 - (1) The minimum number of traffic signal heads for all approaches shall be in conformance with the current edition of the TMUTCD.
 - (2) Generally, one traffic signal head will be provided for each through lane.
 - (3) Generally, the traffic signal heads shall be located directly above the lane line.
 - (4) Typically, a minimum of two left turn traffic signal heads shall be provided. One left turn traffic signal head will be located directly over the lane line between the left turn lane and the adjacent through lane. A second left turn head shall be provided on the far left corner of the intersection. Additional left turn traffic signal heads may be required for multiple left turn lanes.
 - (5) Where there is only one approach lane, two signal heads shall be located at least 8 feet apart, with the center of the separation between the heads located over the center of the lane.
 - b. Size and Configuration:
 - (1) Generally, all traffic signal heads shall be oriented in a horizontal alignment.

- (2) All pole mounted traffic signal heads shall be mounted vertically in line with the pole shaft.
 - (3) All sections of vehicular traffic signal heads shall have 12" LED indications.
 - (4) Protective/permitted left turn signal heads on span wires and on a steel pole, a five-section in-line head shall be used.
 - (5) At split-phase approaches, the left-most head shall be a 4-section head with a left arrow section.
 - (6) Protected only left turn traffic signal heads shall be three section heads consisting of red, yellow and green arrow indications (three arrows).
 - (7) Traffic signal heads located in the Downtown and Uptown District shall be black in color. All other traffic signal heads in the City shall be yellow unless otherwise specified by the City.
- c. Type of Signal Head:
- (1) All signal head housings shall be constructed of polycarbonate in accordance with the Standard Specifications.
 - (2) Optically programmed signal heads shall be used whenever the indications can be viewed by two or more conflicting movements of traffic at skewed intersections, or where two sets of indications for the same direction are not to be viewed simultaneously, such as the second set of indications on the cross street at an offset intersection.
 - (3) Bi-modal indication signal sections shall not be used.
- d. Type of Mounting:
- (1) All mast arm mounted signal heads shall be mounted with fully adjustable "Astro-brac" brackets, or an approved equal.
 - (2) All mast arm mounted traffic signal heads will be mounted on a tenon. If a tenon is not available on the mast arm, a hole should be drilled and a tenon clamp kit used.
 - (3) Post top signal heads with backplates shall be mounted with a mounting meeting the Standard Specifications.
 - (4) Side-mount signal heads shall be mounted using standard mountings and shown on the plans as being on a side of the pole away from vehicular traffic.
- e. Backplates:
All traffic signal heads on steel poles shall be equipped with louvered backplates conforming to Standard Specifications.
- f. Installation Procedures:
The specifications include the requirement that mast arms shall be drilled for wire accesses after installation on the pole base to provide concealed wiring and proper signal head location.

2. Pedestrian Traffic Signal Heads.

a. Type and Number:

- (1) Pedestrian traffic signal heads shall be installed wherever crosswalks are provided, except crossing free right turn lanes.
- (2) Two pedestrian traffic signal heads shall be installed, one at each end of the crosswalk being controlled. Do not locate pedestrian signals on median islands (adjacent to left turn lanes) unless directed to do so by the City.

b. Legend:

- (1) Generally, all pedestrian signal heads shall have international symbol messages consisting of a Portland orange hand and a lunar white walking man.
- (2) At locations where only a portion of the intersection is being rebuilt, older pedestrian traffic signal indications shall be converted to man/hand style indication.

c. Size and Configuration:

- (1) All pedestrian traffic signal heads shall have 16" LED Countdown indications.
- (2) Pedestrian traffic signal heads located in the Downtown and Uptown District shall be black in color. All other pedestrian traffic signal heads in the City shall be yellow unless otherwise specified by the City.

d. Location:

Pedestrian traffic signal heads shall be located as nearly in line with the crosswalk as possible. If the mast arm pole is located such that the pedestrian signal will be blocked by stopped vehicles or if it is more than 20 feet outside of the crosswalk lines extended, then an alternative means of mounting shall be designed. Pedestrian traffic signal heads shall be mounted 7 feet (to the bottom of the head) above the walking surface on the side of pole away from vehicular traffic. Pedestrian traffic signals shall be shown on the plans as being mounted on the side of the pole away from vehicular traffic by use of the symbol.

3. Relocating Traffic Signal Heads.

Signal heads shall be relocated only when they are in good condition, are in conformance with this section, and no modifications are necessary. The relocation of any traffic signal heads shall require the prior approval of the City.

4. Mast Arm Assemblies and Poles.

Typically, the City requires that mast arm poles be used for all new traffic signal installations. In special cases, the City may allow strain pole installations based on a written recommendation by the engineer explaining the need for a span wire design. Traffic signal heads mounted vertically on a pole shaft shall be allowed as supplemental signal indications, but shall not be used as the exclusive method of mounting traffic signals for any approach without prior approval from the City.

- a. Location (Including Setback):
 - (1) Poles shall be located such the center of the pole is a minimum of four (4) feet from the face of curb.
 - (2) Mast arm traffic signal poles should not be located in the median unless no other option exists. Any mast arm poles located in the median shall require approval by the City prior to the preliminary plan submittal.
 - (3) On streets without curbs, or with speeds greater than 35 MPH, poles shall be located a minimum of 10 feet behind the edge of pavement or 3 feet behind the edge of the paved shoulder, whichever is greater, and should be located 15 feet from a line extended from the edge of the through traffic lanes.
 - (4) Poles should be located in line with the opposing directions stop line (approximately four feet behind the crosswalk line).
 - (5) Poles should be located as close to the sidewalk or pedestrian landing as possible for pedestrian pushbutton access, yet still be within the guidelines for distance from the curb or traveled way.
 - (6) No poles shall be located in wheelchair ramps or such that they are an obstruction to pedestrians or wheelchairs.
 - (7) On the plans, the Consultant shall tie down the location of all poles referenced to the street centerline by station to the nearest foot and offset to the nearest half foot.
- b. Mast Arm Lengths:
 - (1) Mast arms longer than 55 feet in length may require an evaluation of the pole and foundation to be used as determined by the City.
 - (2) Mast arm lengths should allow for probable future modifications to the signal. If a left turn lane exists, the arm should extend to the lane line between the left turn lane and the adjacent through lane. Where permitted or permitted/protected left turn movements are allowed, an R10-12 "LEFT TURN YIELD ON GREEN BALL" sign shall be installed immediately to the right of the traffic signal head over the lane line between the left turn lane and adjacent through lane and below the far left traffic signal head. If the intersection has protected only left turn phasing a R10-5 "LEFT ON GREEN ARROW ONLY" sign shall be installed immediately to the right of the left turn head on the mast arm and below the far left traffic signal head.

c. Clearances from Utilities:

Poles shall be located such that all portions of the poles and attached equipment have clearances from overhead utilities in accordance with the requirements of the local utility and the National Electrical Safety Code (NESC).

d. Material and Style:

- (1) All poles shall conform to the Standard Specifications and Details. Special poles and features shall be coordinated and approved by the City.
- (2) The centerline of the mast arm shall be at 90 degrees to the centerline of the approach it is serving unless otherwise required.

e. Delivery Time:

Typical delivery time for mast arm poles is 8 – 12 weeks from the approval of submittals. The number of days specified in the contract should account for the long delivery time.

f. Luminaries and Luminary Mast Arms:

Are not currently used in the City. If future standard specifications for traffic signal poles include the ability to provide luminaries, the City will inform the designer when to include luminaries in the design.

5. Pedestrian Pushbuttons.

Pedestrian pushbuttons shall be required at all new or modified traffic signal locations within the City of Houston outside of the Downtown. In the Downtown, controllers will be set with a recall for all pedestrian movements to accommodate the anticipated heavy pedestrian movements. The omission of pedestrian pushbuttons at any other locations shall require the approval of the City.

a. All pedestrian pushbuttons shall be Polara Navigator or approved equal Accessible Pedestrian Systems (APS).

b. No more than one pedestrian pushbutton shall be located on a single traffic signal pole.

c. Pedestrian pushbuttons should be located no more than ten (10) feet from the face of curb or more than five (5) feet from the crosswalk extension.

- d. Pedestrian pushbuttons shall be separated by a minimum distance of ten (10) feet.
- e. All pedestrian pushbutton stations shall be accompanied by a pedestrian pushbutton sign (R10-3e) with instructions.

F. Controller and Cabinet Design.

1. Controllers.

All new controllers shall be the Type 2070 Advanced Traffic Controllers (ATC) unless otherwise directed by the City.

2. Phasing.

- a. The sequence of operations shall be shown by the phasing sequence diagram for each intersection on the plan sheet. Permitted movements shall not be indicated unless part of a protected/permitted sequence. All pedestrian movements shall be shown.
- b. Phases shall be designated on the traffic signal plan sheet in accordance with the standard NEMA phase designations. In addition, the phases shall be assigned as follows (unless limited by the controller cabinet). As shown, phases 3 and 8 are to be oriented north.

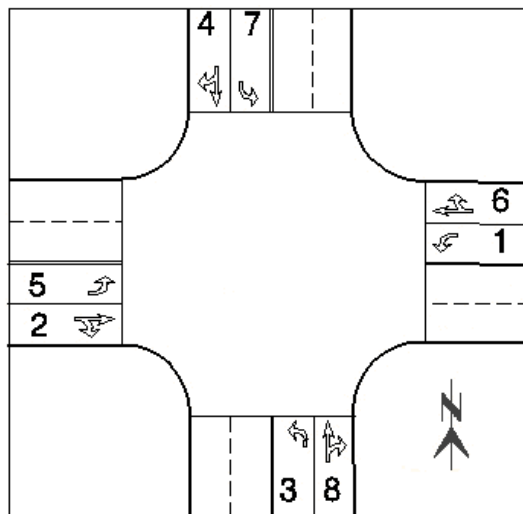

3. Controller Cabinet Type..

- a. New Type 2070 ATC controllers shall be housed in one of a selection of four cabinets from the Standard Specifications:

- (1) Type 340 ITS Cabinet (Housing Package Type 3) – This is the standard cabinet for installation at City of Houston Intersections. This cabinet shall be used at locations where 8-phase operation would be employed in the new or future system, where a 7-wire interconnect master is desired (with auxiliary load rack), or for a master/local on a closed loop system. This cabinet will fit on a standard NEMA “P” cabinet foundation.
 - (2) Type 342 ITS Cabinet (Housing Package Type 1) – The Type 342 ITS cabinet is a smaller cabinet that uses the Type 332 cabinet profile and will fit a Type 332 cabinet foundation. This cabinet should only be used on intersection retrofit projects where the existing foundations and conduit system are to remain. It should not be specified without prior approval by the City.
 - (3) Type 346 ITS Cabinet (Housing Package Type 2) – The Type 346 ITS cabinet generally has the same capabilities as the Type 332 cabinet in a smaller unit. This cabinet does not allow room for a 7-wire or modem unit shall be used where there is not adequate room or right-of-way for a Type 332 foundation, but expandable 8-phase capacity is desired. These cabinets are typically only to be used in the Downtown area and will require prior approval by the City.
- b. Selection of which cabinet to use shall be based on the cabinet use descriptions above, and approved by the City.
4. Controller Cabinet Location.
- a. The controller cabinet should be located to minimize the probability of being hit by a vehicle. Locations particularly susceptible to accident damage are:
 - (1) The far corner (apex) for a dual left turn or right turn movement where the crossing street doesn’t have a raised median.
 - (2) The far corner (apex) for a heavy left turn movement.
 - (3) The far right corner of a high-speed approach where a right angle collision can knock a car into the controller.
 - (4) Generally, the controller should be located upstream on the heaviest approach and/or back from the corner on the minor approach if there is a significant difference in approach volumes or speeds. Consideration should be given to locating the controller where it is protected by an existing non-breakaway pole or a mast arm pole.
 - b. Where possible, the controller should be located on the same corner as the power supply. Special care should be taken that the load center is not separated from the controller by a wide, high speed or high volume street.
 - c. Areas subject to flooding shall be avoided.

- d. Cabinets shall be positioned such that when the door opens, the maintenance personnel will have a clear view of the intersection and the inside of the cabinet. If the cabinet is too high to see over, the cabinet shall be positioned so that the technician has a clear view of the intersection without looking around the open door.

G. Detector Design.

1. General.

The City's practice is to install inductive loop detectors at all new traffic signal installations. The use of video detections or other detection technologies shall require prior approval of the City.

2. Emergency Vehicle Pre-Emption Equipment.

All new City traffic signal installations shall require the installation of 3M Opticom emergency pre-emption equipment. Sensors shall be installed for all intersection approaches. The City of Houston uses a coded system which requires proprietary software. For this reason only 3m Opticom equipment can be used for City installations.

3. Inductive Loop Detectors.

Inductive loop detectors are the standard means of vehicle detection to be used in the City of Houston.

- a. Types of loop installations shall be broken into two categories depending on the proposed pavement work:
 - (1) Pre-formed Loops – Use pre-formed loops any place where the entire loop falls in an area of new, overlaid, milled and replaced, or seal-coated pavement. The excavation and patching required are easily covered up by the pavement work, and the pre-formed loops can last virtually forever, if properly installed.
 - (2) Saw cut Loops – Use saw cut loops if the loop or any part of the loop would end up in an existing pavement that will not be modified by any of the methods noted above. This is a less desirable method of loop installation, but can give acceptable loop life if properly installed.
- b. The detector lead-in cable is a shielded twisted pair cable extending from the loop pull box to the controller cabinet. The detector lead-in cable shall be a continuous run without splices.
- c. Except where noted otherwise, dimensions for detector loop setbacks shall be referenced from stop line. The detector reference line should be curved if needed to follow the alignment of the street.

- d. Each loop shall be connected to its own detector lead-in cable. Multiple detector lead-in cables may run in the same conduit.

4. Identification Scheme.

Detector loops shall be identified on the plan sheets by their phase, lane and purpose. Each lane will be numbered from left to right starting with the lane closest to the centerline. Advance detection loops shall be identified as pulse loops. Detection loops in through lanes at the stop line will be designated as call loops. Finally, detector loops in the turn lanes or on low speed minor approaches shall be presence loops. For example, when speaking about the advance loop for eastbound in the lane closest to the median would be referred to as the Phase 2 pulse loop 1.

5. Advance Loops on Higher Speed Approaches (Posted Speed > 30 MPH).

a. Location.

- (1) For higher speed approaches, it may be necessary to design and install advance loop detectors even when video detection systems are installed.
- (2) For higher speed approaches, advance loop detectors for the through lanes of traffic shall be located five (5) seconds from the stop line using the following table:

Posted Speed Limit (mph)	Design Speed (mph)	Advance Detector Distance (ft)*	Passage Time (sec)
35**	40	300	3.0
40	45	337	3.0
45	50	374	3.0
50	55	410	3.0
55	60	447	3.0

*- As measured from the leading detector edge to the stop line.

** - Presence detection is to be used for side street approaches if the higher through phase critical lane volume for the side street is less than one-half the critical lane volume of the higher volume main street through phase.

- (3) In addition to the advance detectors, call loops in each lane shall be placed near the crosswalk. The front edge of a 6' x 6' detection loop (either pre-formed or saw cut) shall be located four (4) feet back from the stop line. At locations involving skewed intersections, or other extenuating circumstances, the loop positions and sizes may need to be adjusted to account for vehicles stopping in front of or in the

crosswalk. In all cases, detection must be provided 10 feet upstream from the back of the crosswalk. The intent of the loop placement is to prevent the smallest passenger cars, motorcycles and bicycles from being caught in an undetected area. If adjusted, the size and spacing of the loops shall remain constant.

b. Detector Lead-in Cable.

- (1) The upstream pulse loops for the dilemma zone protection shall be on separate detector amplifier channels.
- (2) If there is more than one through lane, adjacent upstream loops shall be placed on separate channels without connection to any other loop.
- (3) The two stop line loops shall be spliced in series at the cabinet and connected to the same detector amplifier. This amplifier shall be the “call” input amplifier, with the loops of each lane split between the two channels.
- (4) The upstream loop detector lead-in cables shall be routed to the nearest junction box along a path perpendicular to the direction of travel. Homeruns for adjacent loops, less than 16 feet apart, should be routed to the nearest junction box in the same cut to the extent possible to minimize excavation of the pavement. When loops are adjacent to medians, the homerun can be routed directly to the median and then to the nearest junction box.
- (5) The stop line loop lead-in cable will generally be routed to the same junction box. All the detector lead-in cables for conduit-encased loops should be routed parallel and adjacent to each other along a path perpendicular to the direction of travel. A path parallel to the direction of travel may be needed from the individual loop to the common perpendicular routing.

6. Low Speed Approaches.

a. Location.

- (1) Large area presence detection shall be used on approaches with less than 35 MPH posted or anticipated 85th percentile speed. It shall also be used on side street approaches, with a posted or anticipated 85th percentile speed of 35 MPH, if the higher through phase critical lane volume is less than one-half the critical lane volume of the highest volume main street through phase.
 - (a) Pre-formed Loops. Large area presence detection shall consist of two (2) 6' x 6' detector loops placed in each lane beginning at the stop line. The second shall be placed an additional 9 feet upstream of the back of the first detector. Saw cut Loops. Large area presence detection shall generally consist of a single 6' x 10' detector loop in a single lane beginning at the stop line.

- (2) At locations involving skewed intersections, or other extenuating circumstances, the loop positions, number or sizes may need to be adjusted to account for vehicles stopping in front of or in the crosswalk. Care should be taken to not leave too much undetected space immediately upstream of the crosswalk. The intent of the loop placement is to prevent the smallest passenger cars, motorcycles and bicycles from being caught in an undetected area. If adjusted, the distances between the pre-formed detector loops shall remain constant.
 - b. Detector Lead-in Cable.
 - (1) In the case of the pre-formed detector loops, the loops in a lane may be combined on one channel. In all cases, each loop shall be spliced to its own detector lead-in cable running back to the cabinet.
 - (2) Detector lead-in cables for the loops closest to the intersection should be routed to the same junction box. Detector lead-in cables for adjacent loops should be routed to the nearest junction box in the same cut to the extent possible to minimize excavation of the pavement. A path parallel to the direction of travel may be needed from the individual loop to the common perpendicular routing.
7. Left Turn Lane Detection.
 - a. Location.
 - (1) Large area presence detection shall be used for left turn lane detections. Pre-formed Loops. Large area presence detection shall consist of four (4) 6' x 6' detector loops placed in each lane beginning in front of the crosswalk line closest to intersection. The additional pre-formed loops shall be placed nine (9) foot intervals upstream starting at the back of the each detector. Saw cut Loops. Large area presence detection shall generally consist of a single 6' x 50' detector loop in a single lane beginning with twenty (20) feet extending beyond the stop line into the intersection. If necessary due to beaks in pavement panels, a series of loops may be cut adding up to a total length of fifty (50) feet.
 - (2) At locations involving skewed intersections, or other extenuating circumstances, the loop positions, number or sizes may need to be adjusted to account for vehicles stopping in front of or in the crosswalk. Care should be taken to not leave too much undetected space immediately upstream of the crosswalk. The intent of the loop placement is to prevent the smallest passenger cars, motorcycles and bicycles from being caught in an undetected area. If adjusted, the distances between the pre-formed detector loops shall remain constant.
 - b. Detector Lead-in Cable.
 - (1) Where medians are constructed adjacent to left turn lanes, the detector lead-in cable(s) should be routed to a junction box in the median.

- (2) In the case of the pre-formed loops, the upstream loop shall be connected to its own channel on an amplifier. The other loops may be combined on one channel. For multiple saw cut loops, the rear loop and front loops shall be on separate channels. In all cases, each loop shall be spliced to its own lead-in cable running back to the cabinet.
- (3) If there are two or more left turn lanes, all the loops in one lane shall be connected in a like manner as described in paragraph b. above.

8. Right Turn Lane Detection.

a. Location.

If detection for a right turn lane is provided, it shall be installed in the same manner as a presence loop for a through lane on a low speed approach.

b. Detector Lead-in Cable.

The right turn presence detection loop shall be connected into its own detector lead-in cable, and separate channel on an extension amplifier for the through phase.

9. Construction of Inductive Loops.

See the Standard Specifications and Details for construction requirements.

10. Video Imaging Vehicle Detection Systems (VIVDS).

The City's practice is to install inductive loop detectors as our standard means of detection. Video detection is only to be used in special cases where the City has approved its use prior to the preparation of final plans.

When using video detection systems, at least one camera shall be installed for each intersection approach.

11. Other Detection Devices.

The engineer may recommend other detection technologies and submit a written recommendation outlining the benefits of the technology. However, the City reserves the final authority to approve or disapprove the use of these technologies.

H. Underground Systems.

1. Conduit.

a. Type of Conduit.

All conduits shall be as specified in the Standard Specifications. The designer must pay careful attention to where the Standard Specifications call for certain

types of conduits for certain uses as well as when boring and encasing is to be used so the estimates can accurately reflect the field quantities.

b. Installation.

- (1) Conduit shall be installed according to the Standard Specifications. Requirements for depth below finish grade shall be strictly adhered to.
- (2) The Consultant, in conjunction with the City, shall determine if conduit crossing certain paved streets should be shown as open cut or bored due to extensive utility problems. The specifications should require an alternate bid option of both methods to allow for unforeseen factors.
- (3) In general, conduit runs crossing paved alleys, drives, and streets shall be bored.

c. Conduit Sizing.

- (1) Conduits shall be sized according to minimum allowed sizes and allowed conduit fill.
- (2) Conduit shall be in 1/2" incremental sizes, with the exception of the rigid galvanized conduits on span-wire installations as shown in the Standard Details.
- (3) Conduit fill shall not exceed 40% on any one conduit or 26% average for all conduits on any one run.
- (4) When crossing the street with interconnects cable, the spare conduit required for a street crossing may be used if adequate capacity is available.
- (5) One (1) inch conduit shall only be used to protect the Street Loop Wire from the loop to the adjacent pull box.

Table 1
Dimensions and Maximum Percentage of Filled Area of Conduit

Trade Size	Internal Diameter (In)	Cross Sectional Area (Sq In)	26% Fill (Sq In)	40% Fill (Sq In)
1"	1.029	0.83	0.22	0.33
2"	2.047	3.29	0.86	1.32
2-1/2"	2.445	4.70	1.22	1.88
3"	3.042	7.27	1.89	2.91
4"	3.998	12.55	3.26	5.02

Source: National Electrical Code; Chapter 9, Table 4.

d. Length of Conduit Run.

Conduit runs should be limited to 190 feet between pull boxes or structures where the cable is reasonably accessible for pulling. If the conduit run is very

straight, with no more than 180 degrees of bend, and contains only a single cable, the run may be extended to about 350 feet.

- e. **Spare Conduits.**
Spare conduits shall be installed as shown in the Standard Details.
- f. **Location of Conduit Runs.**
 - (1) If new sidewalk is part of the construction, conduit runs may be located under the new sidewalk with the junction boxes being constructed flush with the sidewalk.
 - (2) If the sidewalk is existing, and a planting strip exists between the curb and the sidewalk, the conduit and junction boxes should be located either in the planting strip or on the other side of the sidewalk (right-of-way permitting), whichever has fewer utility conflicts.
 - (3) If there is no curb and gutter, the conduit and junction boxes should be located as far as possible back near the right-of-way, but not in drainage areas.
 - (4) Conduit runs shall be located away from drainage collection points whenever possible.

2. **Pull Boxes.**

a. **Size.**

Three sizes are available for use from the Standard Specifications and Details. The designer shall select the applicable box based on number and size of conduits to be contained in the box. If the designer is concerned that the standard pull box will be too small, they should select the next larger size pull box. The three sizes of standard pull boxes used by the City and their applications are:

Type A – To be used for detector loop pull boxes and hardwire interconnect boxes.

Type B – This is the standard traffic signal pull box, but may also be used as a detector loop pull box where multiple pre-formed loops enter a single pull box.

Type C – This is the standard pull box to be used for most communications applications. It can also be used for traffic signals where a large pull box is required due to multiple large conduits entering the pull box. The most frequent use of this pull box in traffic signal construction is for the pull box adjacent to the controller cabinet.

b. **Location.**

- (1) A pull box is generally required adjacent to each loop, set behind the curb or located on the shoulder to minimize being run over by vehicles.
- (2) For low speed approach and turn lane detectors, a junction box should be located to minimize the length of the detector lead-in cable.

- (3) Each quadrant of the intersection shall have a pull box that is within 30 feet of the traffic signal pole. This pull box should service the traffic signal pole, detector lead-in conduit, and the conduit crossing the street. If the intersection is actuated, this pull box can usually be the same box servicing the detectors at the crosswalk, and possibly the left turn detectors if no median island exists. It should be located to allow the most direct path for the detector lead-in cables as well as the conduit crossing the street.
- (4) Pull boxes located on corners should be positioned so that turning vehicles do not track across the pull box.
- (5) At span-wire signal installations, item c. holds true for the pull box location with the exception that you do not have a street-crossing conduit running to this pull box in most cases.
- (6) On the quadrant where the controller cabinet is located, there should generally be only the one pull box which services the conduit crossing the street, some detector loops, traffic signal pole, and the controller cabinet. An additional pull box is required in the Type 332 foundation, per the Standard Detail, and is also required in many cases where the controller cabinet is post-mounted.
- (7) For interconnect runs between intersections, pull boxes shall be provided at appropriate intervals.

3. Traffic Signal Communications.

- a. The City requires that all new traffic signals be interconnected to the existing City of Houston traffic signal system. The standard means of communications is via WiMax radio unless otherwise specified.
- b. For below grade fiber optic communications installations, a four (4) inch conduit with four (4) one inch inner ducts will be used to house the fiber optic cable. Type C pull boxes are required at maximum spacing of five hundred (500) feet along the length of the communications conduit.
- c. Other communications technologies such as wireless systems may be acceptable to the City on a case by case basis.

I. Electrical Cable.

1. Detector Lead-In Cable.

- a. Detector lead-in cable shall be 14 AWG IMSA 50-2-1984 shielded cable meeting the requirements of the Standard Specifications.
- b. All detector lead-ins cables shall be continuous runs from the splice with the loop to the controller cabinet terminal strip.

- c. Each loop shall be individually brought back to the cabinet on a separate shielded cable.
2. Street Loop Wire.

Street Loop Wire shall be 14 AWG IMSA 51-5-1985 cable.
3. Power Cable.
 - a. Power shall be 120 volt, single-cycle, 60 Hz AC.
 - b. All services shall comply with Electric Company requirements and consist of five (5) #4 AWG XHHW stranded wires and an 8 AWG Solid Bare Ground. The five #4 AWG XHHW wires shall consist of two (2) white, one (1) black, one (1) red and one (1) green wires. A black #4 AWG XHHW stranded wire will be used for the “hot” signal leg and a white #4 AWG XHHW stranded wire will be used for the “common” signal leg. The green, red and spare white #4 AWG XHHW stranded wires shall be reserved as spares or for future luminaire usage.
4. Signal Cable.
 - a. Traffic Signal Heads.
 - (1) All traffic signal heads shall be serviced with a 7 conductor, 14 AWG IMSA 19-1-1984 cable meeting the requirements of the Standard Specifications.
 - (2) IMSA cables are to run un-spliced from the controller cabinet to the terminal strip in the pole or to the signal heads where termination in the pole is unavailable.
 - (3) Each approach will require that at least two heads be on separate IMSA cables. For additional heads, cables may be run from the first through head with a second cable from the first head to the additional heads.
 - (4) Each protected/permissive and protected only left turn signal heads shall be serviced by its own cable with no splices to other heads.
 - b. Pedestrian Signal Heads and Pushbuttons.
 - (1) Each pedestrian signal head shall be serviced by its own five (5) conductors, 14 AWG IMSA 19-1-1984 cables with no splices to other heads.
 - (2) Each pedestrian pushbutton shall be serviced by a three (3) conductor, 14 AWG IMSA 19-1-1984 cables.
 - c. Installation, Continuity of Cables, and Splices.

All cable shall meet the requirements of the Standard Specifications for installation, continuity, and splices.

5. Spare Cables.

Where future pedestrian movements or left turn signal heads are anticipated, spare electric cables shall be routed from the controller cabinet to the pole on which they would be installed. In all cases, sufficient spare cable should be provided to connect to the future location of the equipment.

6. Voltage Drop Calculations.

The designer shall take into account voltage drop calculations where applicable due to loss over long distances and consider special exceptions to the wire sizes normally used to accommodate losses.

J. Electrical Services.

1. Type.

The City's standard installation for electrical service will be a service pedestal. All service pedestals and poles shall be as shown in the Standard Specifications and Details and in compliance with the electric company standards.

2. Procedures for Hook-Up to Utility Company.

- a. The utility company shall be contacted for the location of the power source and to verify their procedures for hook-up of power during the design process.
- b. Appropriate notes shall be placed on the plan sheet detailing the Contractor's responsibilities for hook-up, including sufficient advance notice to allow hook-up when the signal system is ready for testing.
- c. The service center shall be a ground-mounted service pedestal when there is to be a steel pole installation. On wood pole span-wire type installations, a wood pole-mounted service assembly is appropriate. Under no circumstances will the electric company or the City allow a meter assembly to be attached to an electric company pole. The assembly has to be located either on a corner signal support pole or a separately installed service pole, put in by the contractor.

K. Signs.

1. General.

All traffic sign codes in this section are from the current additions of the Standard Highway Sign Design for Texas and the TMUTCD.

2. Overhead Mounted Street Name Signs.
 - a. A street name sign (D3, Texas Manual on Uniform Traffic Control Devices) for each approach shall be installed on the mast arm between the pole and the first signal head as shown on the Standard Detail.
 - b. If the two legs of the cross street have different names, two signs with arrows shall be installed in lieu of a single street name sign. The sign on the left shall have an arrow pointing left followed by the street name. To the right of this sign is a sign with the name of the street to the right followed by an arrow pointing right.
 - c. Street name signs shall include block numbers per the Standard Details.
3. Overhead Lane Use Control Signs.
 - a. Left Turn Lane Without Left Turn Signal:
 - (1) Install a R10-12 "LEFT TURN YIELD ON <SYMBOL GREEN BALL>" lane use control sign next to the signal head at the mast arm tip. A second sign shall be installed directly below the pole mounted traffic signal head on the far left corner of the intersection.
 - b. Left Turn Lane With Protected/Permitted Left Turn Signal:
 - (1) Install an R10-12 (LEFT TURN YIELD ON <SYMBOL FOR GREEN BALL>) sign adjacent to the signal head at the mast arm tip. A second sign shall be installed directly below the pole mounted traffic signal head on the far left corner of the intersection.
 - (2) If an existing arm is being used, the sign should be mounted adjacent to the traffic signal head closest to the mast arm tip.
 - c. No Left Turn Lane With Protected/Permitted Turn Signal:
 - (1) Install an R10-12 sign at the end of the mast arm.
 - d. Left Turn Lane With Protected Only Left Turn Signal:
 - (1) Install an R10-5 sign at the end of the mast arm.
4. Median and Island Approaches.
 - a. Median approaches should have an R4-7 Keep Right sign (symbol only) mounted at the nose of the median.

- b. Island approaches, with same directional traffic on both sides shall have a W12-1 Double Arrow sign mounted at the nose of the island.

5. Pedestrian Pushbutton Signs.

Pedestrian Pushbutton signs shall be as shown in the Standard Details.

- a. An R10-3e shall be used at most locations.
- b. An R10-3b may be used at installations where standard pedestrian indications without the countdown feature are used.

6. No Pedestrian Crossing Signs.

An R9-3A sign with plaque shall be installed on the mast arm pole at each side of an approach where no pedestrian signals or crosswalks are used.

7. Diamond Grade Sheeting On Overhead Signs.

All traffic control signs, which are mounted overhead, shall have diamond grade reflective sheeting. This applies to street name signs, one-way signs, turn restriction signs, etc.

8. Other Traffic Signs.

Other traffic control signs, e.g., one-way, left lane must turn left, no right turn on red, no parking, etc., shall be installed as needed. These signs shall meet the requirements of the TMUTCD.

L. Battery Backup/ Uninterrupted Power Supply (UPS) Systems

1. General

The City of Houston shall require the installation of Battery Back Up/Uninterrupted Power Supply (UPS) systems on all new or reconstruction traffic signals. The Battery Backup/UPS System will meet the requirements of the Standard Specifications.

15.12 TRAFFIC CONTROL PLAN

15.12.01 GENERAL

- A. This section of the Design Manual contains general guidelines and instructions to be used in determining appropriate construction sequencing and preparation of traffic control plans. The intent is to establish standard procedures and requirements that will be used by engineering designers and consultants when preparing traffic control plans for City of

Houston projects. In turn consistent application of lane closures and minimal inconvenience to the traveling public will reduce frustration due to negative impacts of construction activities and improve safety because of uniformity of lane/sidewalk closure techniques. All design shall also be in accordance with the latest version of the Texas Manual on Uniform Traffic Control Devices (TMUTCD).

- B. This document provides Designers and Consultants with:
1. requirements and guidelines for ensuring uniformity in lane/sidewalk closure techniques; and
 2. the required format of plan sheets to allow ease of review, minimization of construction errors, and facilitation of maintenance of traffic control setup by the Contractor.

15.12.02 DESIGN REQUIREMENTS

A. Description of Design/Review Process

1. Project Initiation
 - a. Determine Requirements of Other Agencies. If the project falls under TxDOT's jurisdiction, verify TxDOT's traffic control requirements and approval process is needed. The Consultant shall meet with appropriate TxDOT personnel to determine how to prepare the traffic control setup. After the meeting the Consultant shall meet with City of Houston Project Manager/City Traffic Engineer to discuss traffic control plans per TxDOT requirements and come up with an action plan to prepare construction sequencing and traffic control plans. This task could be handled via phone/e-mail correspondence.
 - b. The Consultant shall meet with the City of Houston prior to beginning the construction sequencing and traffic control plans to discuss the project in detail. At this meeting, typical and any conditions that need to be considered in preparation of construction sequencing and traffic control plans will be discussed. The meeting regarding traffic control plans will generally occur as part of other project initiation meetings and design review meetings. Based on the discretion of the City Traffic Engineer and/or City of Houston Project Manager a special meeting may be organized to discuss specifics of the project in regards to construction sequencing and traffic control setup.

B. Data Collection

- a. Collect all data required to produce construction sequencing plans and traffic control plans. Typically, at this stage of the design process proposed improvements and goals of the project have been developed. Therefore, existing topographic survey and/or improvement design sheets will be used as the base file to produce construction sequencing plans.
 - b. The Consultant shall visit the project site to inventory and identify physical features that may impact construction sequencing and traffic control plans such as access driveways to special adjacent properties that may require special considerations in preparing traffic control plans as schools, police stations, fire stations, churches, properties with only one access point, and relatively high demand commercial developments.
3. Plans and Drawings
- a. General
 - (1) All construction sequencing and traffic control design plans shall be prepared on 22" x 34" Mylar reproducible sheets, using the Standard City of Houston, Department of Public Works and Engineering Title Block. Construction sequencing and traffic control plans shall be shown on different plan sheets.
 - (2) All full size designs for construction sequencing and traffic control plans shall be prepared at any scale as long as the notes and callouts are readable.
 - (3) All construction drawings shall be prepared in accordance with Chapter 3, Graphic Requirements.
 - (4) On projects where the Consultant finds it necessary to deviate from the standard format presented herein, due to project scope or design requirements, the City's Project Manager should be consulted to determine an acceptable alternate format. Any changes to the format are at the discretion of the City's project manager.
 - (5) Construction sequencing plan should include all aspects of the improvement project such as removal of existing features such as curb, pavement, signs, implementation of temporary pavement to facilitate traffic, implementation of temporary signal locations, and installation of all proposed elements of the project.
 - (6) Each phase of construction sequencing plan shall have separate traffic control plan including associated detour routes and signal modification

plans as necessary. The Consultant should look into using standard lane closures to reduce the number of plan sheets from phase to phase. In addition, if simple signal head adjustments are need for signal modification of different phases, the Consultant is encouraged to only use one signal modification plan for different phases.

- (7) Each phase of construction sequencing plan shall make every effort to leave existing sidewalk accessible to pedestrians while project related improvement activities commence forward. Complete sidewalk closure must be minimized as much as possible.
- (8) The contractor shall provide 11 foot travel lanes on traffic control plans outside the Central Business District (CBD), and a minimum 10 foot wide travel lanes within the CBD. Any deviation will have to be approved by the City Traffic Engineer.
- (9) The Contractor shall provide at a minimum two traversable lanes within the CBD. Any deviation will have to be approved by the City Traffic Engineer.
- (10) Lane closures on Major Thoroughfares according to the latest classifications by the Planning and Development Department; existing directional vehicular movements shall be maintained throughout the duration of the construction project. There may be special construction activities that may require limitations of movements on major thoroughfares. These situations must be approved by the City Traffic Engineer. Typically, such approvals are associated with peak period restrictions and/or special traffic control plan and requirement of extensive advertisement to the traveling public especially to stake holders substantially impacted in the vicinity.
- (11) Trench walls should not be three feet from the edge of the traveled way at any stage of the construction.
- (12) Traffic control devices shall be in place before starting any excavation.
- (13) For vertical drop-off greater than one foot along roadway, low profile concrete barriers with appropriate end protections must be installed.

b. General Notes.

The following General Notes should appear on all pavement marking design sheets. Additional notes may be added by the Consultant as may be necessary to properly clarify the intent of the design.

- (1) The Contractor shall provide and install traffic control devices in conformance with Part VI of Texas Manual on Uniform Traffic Control Devices (TMUTCD) latest edition with revisions during the entire construction period.
- (2) All signs and traffic control devices shall conform to the latest version of the TMUTCD.
- (3) No lanes shall be closed during the hours of 7:00 AM to 9:00 AM and 4:00 PM to 6:00 PM Monday thru Friday without approval of the City Traffic Engineer.
- (4) No work shall be performed in residential areas from 7:00 PM to 7:00 AM.
- (5) Contractor shall maintain approved number of thru lanes of traffic in each direction during construction working hours. Traffic control plans shall include one-way and/or detour plans.
- (6) Contractor shall maintain traffic lanes and detours according to traffic control plans during working hours.
- (7) Contractor shall cover open pavement excavations for minor utility work with anchored steel plates during non-working hours, and open lanes for normal traffic flow when feasible.
- (8) If the Contractor chooses to use a different method of "Traffic Control Plans" during the construction than what is outlined in the contract drawings, the Contractor shall be responsible to prepare and submit an alternate set of traffic control plans to the City of Houston Project Manager for approval ten working days prior to implementation. These plans shall be drawn to scale on reproducible mylars and shall be sealed by a Licensed Engineer in the State of Texas. Traffic Operations Division representative approval is required to accept the proposed changes.
- (9) Contractor shall secure lane/sidewalk closure permits from Traffic Operations Division (Mobility Permit Section at <http://www.gims.houstontx.gov/portalWS/MainPortal.aspx>) before

implementing the traffic control plan. The application must be submitted at least ten business days prior to the implementation of the traffic control plan and/or beginning construction work. The Contractor shall provide traffic control plans, construction sequencing, and construction schedule with the application.

- (10) Contractor shall have approved traffic control plan and permit at the job site for inspection at all times.
- (11) During pavement surface restoration projects; the Contractor shall not open closed lanes until the pavement surface has cured enough to allow vehicular traffic according to City of Houston Standard Specifications.
- (12) The Contractor is responsible for scheduling and coordinating all construction activities with stake holders in the vicinity including emergency response agencies such as Houston Police Department, Houston Fire Department, and Metropolitan Transit Authority.
- (13) Contractor shall be responsible for issuing all work directives to all sub-contractors, utility companies, and all other entities performing construction work associated with the project.
- (14) Nothing in these notes or plans shall relieve the Contractor of the responsibility for job site conditions during the course of construction of the project; including safety of all modes of transportation, persons, and property, and that this requirement shall apply continuously and not be limited to working hours.
- (15) The Traffic Operation Division (Mobility Permits Group) per the direction of the City Traffic Engineer have the right to demand the installation of additional traffic control devices or modifications to these plans and notes, as deemed necessary to promote the safe and orderly flow of traffic and pedestrians through the construction work zone. The Contractor shall comply with these additional requests or modifications with due diligence.
- (16) All existing traffic control signs and pavement markings shall be maintained in visible locations during construction unless prior written approval is obtained from City of Houston Project Manager. The Contractor shall restore or replace (at the discretion of the City Traffic

- Engineer) any pavement marking or signing damaged during construction operations, including Raised Pavement Markers (RPMs).
- (17) When entering or leaving roadways carrying public traffic, the Contractor equipment, whether empty or loaded shall in all cases yield to public traffic with the assistance of Contractor provided certified flagger/peace officer.
 - (18) Access to driveways adjacent to the construction work zone shall be maintained at all times as much as possible. Additional cones delineators may be required to delineate the driveway access route through the construction work zone. A minimum of one travel lane shall be maintained across the driveways, unless prior written approval is obtained from City of Houston Project Manager.
 - (19) Spillage resulting from hauling operations along or across any public traveled way shall be removed immediately by the Contractor.
 - (20) The Contractor shall submit an application for temporary parking restrictions if there are parking meters located at the proposed lane closures from Parking Management Division (832-393-8690) at least ten business days before implementation of lane closures. In addition, temporary no parking signs shall be posted 24 hours prior to commencement of work.
 - (21) Additional off duty police officers/flaggers may be requested to direct traffic when lanes are blocked at the discretion of the City Project Manager even if they are not specifically identified on the project plans.
 - (22) The Contractor shall replace within 72 hours, all traffic signal loop detectors damaged during construction.
 - (23) In general, a solar powered flashing arrow board shall be required on all major thoroughfare lane closures. Exceptions to flashing arrow boards and/or implementation on residential lane closures shall be approved by the City Traffic Engineer.
 - (24) Approved traffic control plan shall be in place before starting any excavation.
- c. General Notes and Channelization Spacing (Refer to City of Houston Standard Drawing 01512- 01)

- d. General Lane Closure Guidance (Refer to City of Houston Standard Drawing 01512-02)
- e. General Detour Guidance (Refer to City of Houston Standard Drawing 01512-03)
- f. Long Term Major Street Lane Closure (Refer to City of Houston Standard Drawing 01512-04)
- g. Long Term Minor Street Lane Closure (Refer to City of Houston Standard Drawing 01512-05)
- h. Short term Minor Street Intersection Lane Closures (Refer to City of Houston Standard Drawings 01512-06 through 01512-12)

15.13 MINIMUM VERTICAL CLEARANCE

15.13.01 GENERAL

This section of the design manual contains the requirements for minimum vertical clearances for structures, utilities and traffic control devices.

15.13.02 REFERENCE

- A. Texas Manual Uniform Traffic Control Devices (TMUTCD)
- B. American Association of State Highway and Transportation Officials (AASHTO)
- C. American Railway Engineering and Maintenance-of-Way Association (AREMA)

15.13.03 MINIMUM VERTICAL CLEARANCE GUIDANCE

- A. Pedestrian Sky Bridges
Refer Chapter 16, Miscellaneous, for sky bridge clearance requirements.
- B. Overhead Traffic Signal Devices
Refer Chapter 15, Section 11 of this manual and Traffic Signal Detail # 02893 for minimum clearance requirements for overhead traffic signal devices.
- C. Traffic Signs
Refer Chapter 15, Section 09 traffic signal section of this manual, and TMUTCD for overhead sign installation requirements.

- D. **Vehicular Bridge**
The bottom of the lowest point of the structure in the public right of way should be a minimum of 14.5 feet over the entire roadway width. If a clearance is less than 17.5 ft, it must contain appropriate signs, and it requires approval of the City Engineer and the City Traffic Engineer.
- E. **Building Structures Over Public Right of Way**
The bottom of the lowest point of the structure in public right of way should be a minimum of 18.5 feet over the entire roadway width.
- F. **Railroad Overpass Clearances**
Highway structures over railroads are referred to as railroad overpasses. Vertical clearance for new structures over railroad tracks must be 23 feet minimum. In cases where electric powered trains are involved, additional vertical clearance may be required.
- G. **Obtain approval from Office of City Engineer for exception or deviations from these requirements.**

15.14 TRAFFIC ENGINEERING STUDY FOR DESIGN

15.14.01 GENERAL

In the early stages of a design project, various studies may be required to establish critical criteria for street or roadway design, including design level of service, sight distance, and access management, which are needed to establish the configuration of the primary elements of the work.

Access management is particularly important in that it determines driveway locations, where medians and median openings are needed, and the types of access and turn restrictions that should be imposed to facilitate the movement of traffic and preserve the integrity of the roadway function within the infrastructure network. In some instances, it may be appropriate to employ computer simulation modeling to determine the relative effectiveness of various alternatives.

- A. The recommendations of the Traffic Engineering Study for design will address such issues as the required number of through lanes, auxiliary lanes, signals and other traffic control improvements, access management, and alternative mode improvements (i.e., bicycles, pedestrians, and buses).
- B. The recommendations will guide the design of the proposed roadway and intersections, as well as the specific design of traffic engineering features.
- C. The Traffic Engineering Study will comply with requirements of the most recent versions of the Texas Manual on Uniform Traffic Control Devices (TMUTCD), Transportation Research Board Highway Capacity Manual (HCM), AASHTO A

Policy on Geometric Design of Highways and Streets (“Green Book”), and other standards of traffic engineering practice, as appropriate.

- D. Computer simulation modeling software used in the development of the Traffic Engineering Study must be approved by the City Traffic Engineer for use.
- E. The study findings will be summarized and documented in the Traffic Engineering Report (TER) for design.
- F. The following sections illustrate generalized list of items to be considered within the TER. Specific scope and level of detail can be modified by the Project Manager in coordination with the City Traffic Engineer to tailor the study effort to the specific design project.

15.14.02 TRAFFIC ENGINEERING REPORT FOR DESIGN

- A. Executive Summary — a two-page (maximum) summary of key features of the report, suitable for distribution as an informational handout on the project at public open houses or meetings with citizens.
- B. Introduction — a general project description, location map, and aerial photo of the project, identifying significant landmarks in the vicinity.
- C. Existing Conditions
 - 1. Roadway — Inventory of existing conditions for all roadways, intersecting roadways, and intersections to be improved, including a scaled drawing of existing conditions. At a minimum the inventory will include, but not be limited to, the following:
 - a. roadway geometry and typical roadway cross sections including median treatments and channelization;
 - b. auxiliary lanes (left- and right-turn lanes);
 - c. inventory of traffic-control devices (signs, signals, pavement markings, school zones);
 - d. posted speed limits;
 - e. identification of existing schools and other major traffic generators, including those in development; and alternative transportation modes (bus routes and existing and proposed pedestrian and bicycle facilities).

2. Traffic data — the traffic data collection schedule shall be coordinated and approved by the City Traffic Engineer. Traffic counts should be recorded only on typical weekdays (not subject to special events or incidents that could affect typical traffic patterns or volumes) during a continuous 48-hour period between 12:00 noon on a Monday and 12:00 noon of the following Friday. Data collected should include:
 - a. Turning movement traffic counts for critical intersections (a.m. and p.m. peak hours). Critical intersections will be determined during the project scoping process. New data will be collected if existing data are more than two years old or, for projects located in high-growth areas, if existing data are more than one year old, as directed by the Project Manager in coordination with the City Traffic Engineer. The design consultant will check with the Traffic Operations Division for existing data.
 - b. Hourly approach traffic volume counts for one full 24-hour period at critical intersections may be needed, as determined by the Project Manager in coordination with the City Traffic Engineer. New data will be collected if existing data are more than two years old. The consultant will check with the Traffic Operations Division for existing data.
 - c. Directional Average Daily Traffic (ADT) and hourly volumes on the improvement roadway between existing signalized intersections and other intersecting major streets and side streets deemed critical. New data will be collected if existing data are more than two years old. The consultant will check with the Traffic Operations Division for existing data.
 - d. At least one year of roadway and critical intersections collision data (city data) and associated collision rates, based on the most recent data available from Houston Police Department may be needed but not required. Prepare a collision data summary spreadsheet and collision diagram.
 - e. Capacity and level-of-service analyses for existing conditions along the segments and at critical intersections (a.m. and p.m. peak-hour periods).
 - f. K (proportion of the ADT occurring in the peak hour) and D (proportion of the peak-hour traffic in the peak direction) factors.

- g. Peak-hour factor by approach and by movement at critical intersections as determined by the project manager in coordination with the traffic engineer.
 - h. Heavy vehicle (truck and bus) percentage during the peak a.m. and p.m. peak periods.
 - i. Intersection and roadway lighting.
 - j. Intelligent Transportation Systems (ITS) based on Traffic Operation Division data.
- D. Future Projected Design Conditions
- 1. Determine the a.m. and p.m. peak-hour volumes for all roadways, intersecting roadways, intersections, and major driveways within the limits of the project or as determined by the Project Manager in coordination with the City Traffic Engineer. These volumes shall be determined for the opening year and the design year (typically 20 years into the future). The volumes will be based on existing traffic volumes and on traffic projections prepared by the City of Houston or by Houston-Galveston Area Council regional transportation demand model.
 - 2. Determine capacity and level of service (LOS) for opening year and design year on the roadway and at critical intersections (a.m. and p.m. peak-hour periods).
 - 3. Address traffic impacts on adjacent neighborhoods (both during and after construction), including traffic calming and access management issues.
 - 4. Prepare traffic signal warrant analyses for the project opening year at critical intersections as determined by the Project Manager in coordination with the City Traffic Engineer and identified in the project scoping process. Traffic signal warrant analyses will be conducted in accordance with Section 15.11.
- E. Conclusions and Recommendations
- 1. Summary of improvements necessary to achieve the design level of service determined by Project Manager in coordination with the City Traffic Engineer (typically LOS "D") and address identified safety issues.
 - 2. Speed zones, including school speed zones.
 - 3. Alternative transportation modes (bus routes, pedestrian and bicycle usage, and facilities).

4. Design parameters (design speeds, design vehicle, sight distances, shoulders, access control, and clear zones).
5. Access management features.
6. Proposed roadway typical cross sections and intersection typical cross sections.
7. Auxiliary lanes (left- and right-turn lanes, acceleration and deceleration lanes) including recommended lengths per City approved methodology to achieve design LOS.
8. Critical intersection traffic control.
9. ITS based on Traffic Operations Division program requirements.
10. School zone flashing beacons.
11. Conceptual improvement diagram illustrating recommended improvements.

15.15 NEIGHBORHOOD TRAFFIC MANAGEMENT PROGRAM

15.15.01 GENERAL

- A. The City of Houston, Public Works and Engineering Department, Traffic Operations Division administers the Neighborhood Traffic Management Program (NTMP) per the requirements of City of Houston Code of Ordinances Chapter 45, Article XV.
- B. Due to House Bill 3082, the City of Houston is obligated to go through the NTMP process as prescribed by City of Houston Code of Ordinances Chapter 45, Article XV in order to implement traffic calming devices within City of Houston jurisdiction.
- C. Traffic calming device is any type of device consisting of the physical structure or other improvement constructed, placed, whether on a temporary or a permanent basis to mitigate speeding or cut-through traffic on local streets such as but not limited to speed cushions, speed humps, median islands, traffic circles, chicanes, chokers, and raised pedestrian crossing islands.
- D. All proposed traffic calming measures shall have to go through the NTMP process before implementation. The requestor shall contact the NTMP group, at 832-395-3000. In addition, detailed information on the process, brochure, and application form can be obtained at <http://www.publicworks.houstontx.gov/traffic/programs.html>.

15.15.02 DESIGN REQUIREMENTS ON ROADWAYS WITH ALREADY APPROVED TRAFFIC CALMING DEVICES

A. Description of Design/Review Process

1. Project Initiation

- a. The Consultant shall meet with the City of Houston prior to beginning the redesign/replacement of traffic calming devices to discuss the project in detail. At this meeting, typical and any specialty items in regards to the traffic calming measures will be discussed. The meeting regarding traffic calming measures will generally occur as part of other project initiation meetings and will not require a separate meeting.

2. Collect Traffic Calming Measures Data and Design

- a. Collect all data required including but not limited locations of existing speed humps, speed cushions, and any other traffic calming devices.

3. The City of Houston does not use speed humps anymore. Therefore, all existing speed humps within the affected construction limit of a given project shall be replaced with speed cushions per the requirements of City of Houston Standard Drawing 01515-01 as part of the improvement project and using the project funds.

4. Typically, all existing traffic calming devices shall be returned in place at the same location unless directed by the City Project Manager/City Traffic Engineer to adjust.

15.15.02 NTMP PROCESS

- A. The NTMP process is detailed in the City of Houston Code of Ordinances Chapter 45, Article XV. In summary Figure 15.15.01 shows the process including the requirements of City Council approval.

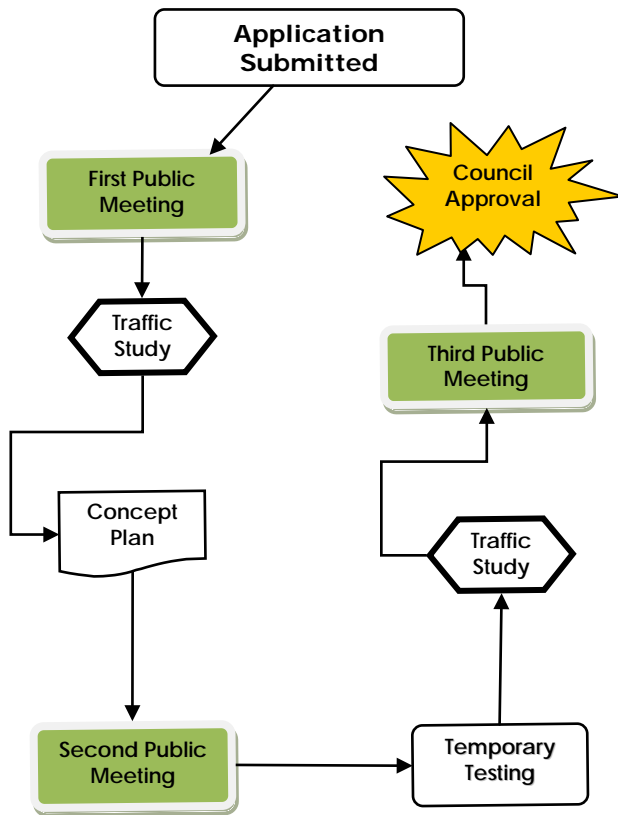

Figure 15.15.01 – Summarized NTMP Process

- B. Typically, the NTMP group directs an applicant through the process. In some cases, a neighborhood group or organization may choose to use a Consultant to go through the process, and construct the traffic calming devices using private funds.
1. The Consultant tasked by the group shall meet with the City of Houston Traffic Operations Division staff responsible for the NTMP prior to starting the design. At this meeting, there will be discussion of the level of involvement by the Consultant to go through the process.
 2. Depending on the Consultants plan in performing the tasks and request to use City of Houston resources; there may be a waiting period to start the process.

15.16 TRAFFIC, SIGNAL, AND STREETLIGHT DESIGN REQUIREMENTS

15.16.01 DESIGN REQUIREMENTS

The following design requirements are applicable within the City street rights-of-way:

A. Streelight Design

1. The primary purpose of street lighting is to illuminate roadway. Street lights are not intended for providing security lighting, pedestrian lighting, parking lots lighting or any other private property lighting. A street segment must be within the City limits in order to be eligible for street lights. All street lights are installed, owned and maintained by Center Point Energy. However, the City must approve for any street light installation that is within the City right-of-way. Once it is installed, the City pays for the operating and maintenance cost of the street light.
2. Street light types - The City of Houston standard street light type includes High Pressure Sodium (yellowish in color) light fixture mounted on wooden pole or metal pole.
 - a. Wood Pole Lights: The City will authorize for street light installation on wooden utility poles wherever possible. The wooden poles will have overhead distribution lines.
 - b. Metal Pole Lights: If an area does not have existing wooden pole with overhead distribution lines, then a metal street light served by underground lines will be installed. There may be a cost associated with this type of installation.
 - c. Wattage: The City will typically install 100-Watt High Pressure Sodium light in residential areas and 250-Watt High Pressure Sodium light along major thoroughfares or collector streets.

3. Street light spacing requirements

Metal pole street lights are typically installed approximately 200 feet apart with 10 feet for property line adjustment. Street lights are typically installed on public right-of-way avoiding obstructions such as trees, manhole, and inlets.

Spacing for installing street lights on wooden utility poles may vary depending on the existing location of the wood poles. However, spacing will normally be 150 to 200 feet apart for adequate roadway illumination.

4. Cost for street lights

Typically, there is no charge to the applicant for any street light that can be installed on an existing wooden pole, or any street light (wooden or metal) that is installed on a roadway that is classified as a major thoroughfare. Although, there is a charge applicable for the installation of a new street light on a metal pole. This charge is in accordance with the City of Houston Code of Ordinance Chapter 40, Section 40-3. The ordinance requires the applicant to pay for the first year's operating cost prior to authorizing the installation of the street light. This is only a one-time charge to the applicant. The cost may vary depending on the type of the street light. In most instances, the cost is generally estimated around \$200.00 per street light.

5. Street light survey application

A Street Light Survey Request Form is available through the City of Houston website (www.publicworks.houstontx.gov/trafficdocuments.html) or by calling (832) 395-3000. This application must be completely filled out and submitted to the City by mail or by fax. Upon receipt of the application, the City will conduct a street light survey and provide a written response in approximately 2 to 4 weeks. If the City determines that street light is necessary as a result of the survey, the City will authorize Center Point Energy for street light installation.

6. Enhanced street light

The street light program also offers enhanced street lights upon request. Locations and types of enhanced street lights must meet the following requirements:

- a. Locations of enhanced street lights must be within a current Management District, Tax Increment Reinvestment Zone (TIRZ), recognized by City of Houston.
- b. Enhanced street light must be approved by the Street Light Program coordinator coordinated with City's other Capital Improvement Project.

15.17 RESERVED FOR COMPLETE STREET CLOSURE

15.18 RESERVED FOR INTERSECTION TURNING TEMPLATES / DESIGN VEHICLES

15.19 CONTEXT SENSITIVE DESIGN

The City of Houston encourages the use of context sensitive design principles such as those in the ITE Recommended Practice, Designing Walkable Urban Thoroughfares: A Context Sensitive Approach. Where an engineer is proposing a context sensitive approach that is in conflict with this manual, they will be treated as a variance. The engineer should meet with

the Office of the City Engineer to discuss the standards to be used and whether they are appropriate to the proposed project.

END OF SECTION

City of Houston

Design Manual

Chapter 16

MISCELLANEOUS

Chapter 16

MISCELLANEOUS

16.01 CHAPTER INCLUDES

- A. Criteria for miscellaneous facilities within the public right of way including:
 - 1. Tree protection
 - 2. Residential subdivision markers
 - 3. Sky bridges.

16.02 REFERENCES

- A. Refer to list of references in Chapter 1, General Requirements
- B. City of Houston Code of Ordinances
- C. American Association of Nurserymen, 1986 edition.

16.03 DEFINITIONS

- A. Drip line – Imaginary circle drawn around a tree, extending to the tree’s branching limit.
- B. Entrance marker - Ornamental gate(s), column(s), or other ornamental works of wood, iron, masonry, earth or other materials denoting the entrance to a platted and recorded single family residential subdivision.
- C. Esplanade – Unpaved area between two paved roadway sections.
- D. Parkway – Area lying between the street curb or edge of roadway paving and the adjacent property line.
- E. Protected Tree – Corridor tree, designated tree, green corridor tree or parkway tree as defined by Chapter 33 of the City of Houston Code of Ordinances.
- F. Street Right-of-Way – Entire width between the boundary lines of every way which is held by the city, county, state or otherwise by the public in fee or dedication when any part thereof is open to the use of the public for purposes of vehicular travel.
- G. Tree-any evergreen or deciduous tree which at the time of planting has a caliper equal to or greater than 1 1/2 inches as measured six inches above the root collar, which is not less than

six feet in height as measured from the root collar, and which meets the Standard for Nursery Stock Specifications.

16.04 TREE PROTECTION

A. Tree Protection Requirements

Tree protection requirement is designed to protect trees in a time of any construction activity, including, without limitation, construction or repair of buildings or other structures, installation or repair of utilities, or installation or repair of streets or sidewalks within the drip line circle area of any protected tree that is not to be removed, without complying with the applicable provisions.

1. Trees to be preserved must be clearly tagged in the field with ribbon.
2. Protection barrier shall be composed of wood, wire, snow fence and braces of similar non injurious material.
3. Tree wells shall be made of a durable material and set a minimum of four feet from any tree they are designed to protect.
4. Retaining walls of a durable material, i.e., stone, or treated lumber, are to be constructed around each tree immediately after the grade is lowered. A retaining wall must be at least four feet from the tree it is designed to preserve.
5. Any under story clearing within six feet of existing tree trunks should be done by hand.
6. No building materials are to be stacked or stockpiled within the drip line or within six feet of any tree to be preserved, whichever is greater.
7. Topsoil shall not be stockpiled within the drip line or within six feet of any tree to be preserved, whichever is greater.
8. Selective thinning of dead or dying vegetation, tree stumps and other undesired growth is required in buffer areas. Supplemental vegetation shall comply with the landscape buffer requirements.
9. Tree boarding should be used if work is required with in construction fencing.
10. Where possible, utility lines shall be tunneled beneath tree roots in order to protect feeder roots, rather than trenched or open cut.

B. Tree Root Barriers

1. Tree root barriers will be used for planting of new trees, to prevent the uncontrollable

spread of tree roots, following root pruning, to protect land and hardscapes from root damage.

2. It can be designed for surround or linear application depends on the hardscape to be protected, distance from surrounding trees, the aggressiveness of the tree, rooting depth of the tree(s).
3. Holes for the tree should be excavated two feet greater in width than the diameter of the soil ball.
4. The size of root barriers should be three times the diameter of the root ball.

16.05 RESIDENTIAL SUBDIVISION MARKERS

A. General Considerations/Restrictions

1. Subdivision markers may display the name of the subdivision or neighborhood but shall not contain any commercial advertising, announcement, or other signage.
2. An electronic sign or marker is not allowed.
3. Subdivision markers may not be located on, extend on to, nor:
 - a. Intrude upon any portion of a roadway.
 - b. Intrude upon any portion of a sidewalk or pedestrian pathway in the public right of way.
 - c. Create any hazardous condition or obstruction for vehicular or pedestrian travel upon a public street.
 - d. Be located within five (5) feet of underground storm, sanitary sewer, water lines and all appurtenances.
 - e. Be located within 25 feet of a fire hydrant,
 - f. Restrict or block driver's visibility or sight line of traffic, pedestrians, bikeway travelers, or other public user within the right of way,

- g. Be located within the visibility triangle.

B. Locations

1. Subdivision markers may be located at the main entrance to a subdivision and at secondary entrances.
2. The subdivision marker must be within the boundaries of the subdivision or single family residential development they identify.
3. Locations where multiple subdivisions interface will be reviewed on a first come, first serve basis for purposes of establishing allowable subdivision marker locations.
4. The City Engineer's approval will be required for installation of more than two markers to identify a single subdivision.
5. The following are minimum allowable entrance marker location guidelines:
 - a. 50 feet from the median nose for mid-block median openings,
 - b. 75 feet from the median nose for intersection openings,
 - c. 100 feet from the median nose of median for left turn lanes,
 - d. Seven (7) feet from the inside median curb (this dimension may be reduced if community has entered into maintenance or Adopt-an-Esplanade agreement with Houston Parks and Recreation Department and does not create a hazardous condition),
 - e. Within right-of-way adjacent to property line.

C. Size

1. Maximum height above the ground surface shall not be greater than six (6) feet.

2. Height shall be limited to not obstruct sight lines of vehicular and pedestrian traffic.
3. Maximum horizontal width shall not exceed eight (8) feet.
4. Maximum display area shall not exceed 36 square feet.
5. Width shall be limited to not obstruct sight lines of vehicular and pedestrian traffic.
6. Variances to the size requirements for a proposed subdivision marker must be granted by the City Engineer.

D. Materials

1. Materials for base structure shall be permanent, durable, and weather resistant.
2. Marker shall provide pleasing aesthetic elements, clarity, and professional design appearance.
3. Marker letters and/or other elements should be of non-corrosive and non-staining materials, and coated properly to prevent staining and discoloration.
4. Material selections should be capable of clean-up from graffiti mark ups.

E. Utilities

1. Marker shall be of size and location to not impede or restrict the City's ability to maintain, repair, or replace the existing utility line(s).
2. Existing utilities shall be field located prior to the construction of the entrance marker. It is recommended that existing utilities shall be field located prior to preparation of the measured drawings for the entrance marker and its location.

F. Plan Reviews/Permits

1. Drawings shall be submitted to the office of City Engineer for review and approval.

2. Drawings shall show existing surface and buried facilities within the right of way or easements in plan view.
3. If entrance marker design includes landscaping, the growth characteristics of the plants shall be submitted with the drawings.
4. Subdivision markers are considered encroachments in the public right-of-way and shall meet the encroachment requirements set out for subdivision markers in Chapter 41 of the City of Houston Code of Ordinances.
5. A construction permit will be required prior to construction of a subdivision marker within the public right of way or public easement. The construction permit will be obtained by the applicant from 3300 Main, Traffic/Paving Permits Section, upon submittal of approved plans and appropriate encroachment permit.

16.06 SKYBRIDGES

A. General Requirements

1. A skybridge, as defined in this Chapter, permits pedestrian and other access between two adjacent structures (not necessarily under the same property ownership) via an elevated structure or bridge within the public right of way.
2. Skybridges may be open air or conditioned space depending upon the specific location and application.
3. Skybridges shall not interfere with the operation of the public right of way across which it traverses and is subject to following height restrictions:
 - a. The bottom of the lowest portion of the skybridge over the public right of way must be a minimum of 18.5 feet above the roadway surface.
 - b. Clearances less than 18.5 feet require review a variance and approval of the City Engineer.

4. Skybridges proposed to traverse an intersection of two public street rights of way requires approval of the City Engineer.

5. Skybridges are considered encroachments in the public right-of-way and shall meet the encroachment requirements set out in Chapter 41 of the City of Houston Code of Ordinances including all administrative, permitting and fees.

END OF SECTION